

|            |             |       |       |
|------------|-------------|-------|-------|
| 1: 10.6x → | 6: 10.8x ↙  | Serie | 105.3 |
| 2: 10.3x ↓ | 7: 10.9x ↑  |       |       |
| 3: 10.9x   | 8: 10.6x ↙  | Total | 105.3 |
| 4: 10.3x ↙ | 9: 10.2x ↓  |       |       |
| 5: 10.3x ← | 10: 10.4x ↓ |       |       |

|             |             |       |       |
|-------------|-------------|-------|-------|
| 11: 10.9x   | 16: 10.5x ← | Serie | 105.0 |
| 12: 10.5x ← | 17: 10.2x → |       |       |
| 13: 10.7x ↗ | 18: 10.5x ↙ | Total | 210.3 |
| 14: 9.9 ↙   | 19: 10.5x → |       |       |
| 15: 10.6x ← | 20: 10.7x ↓ |       |       |

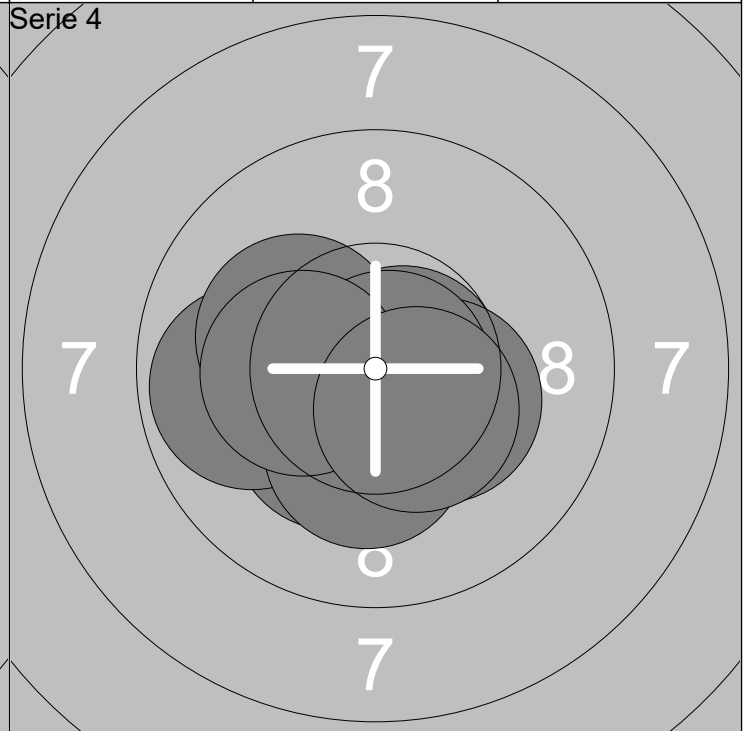
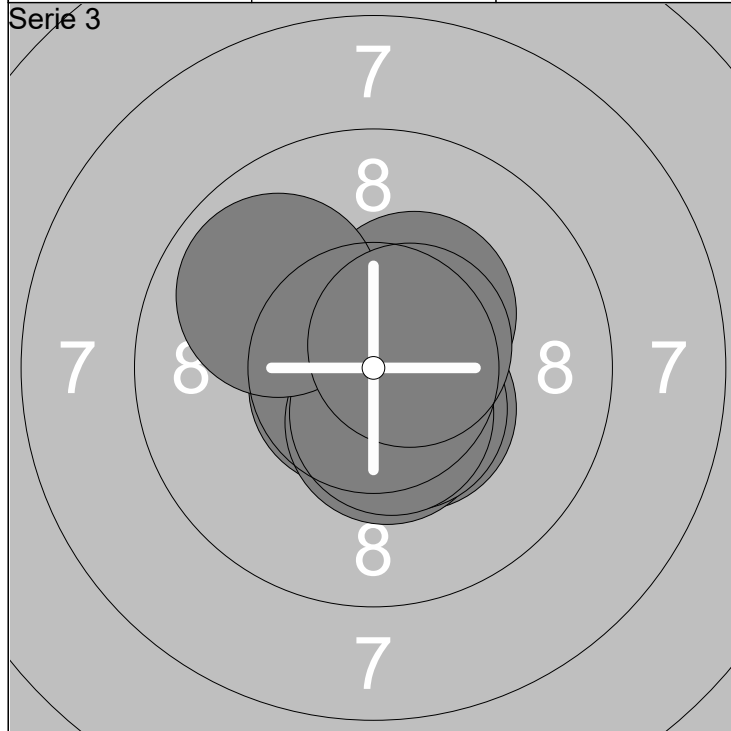

|             |             |       |       |
|-------------|-------------|-------|-------|
| 21: 10.4x ↘ | 26: 10.4x ↓ | Serie | 104.8 |
| 22: 10.7x → | 27: 10.5x ↓ |       |       |
| 23: 10.3x ↗ | 28: 10.5x ↓ | Total | 315.1 |
| 24: 10.7x ↙ | 29: 9.9 ↗   |       |       |
| 25: 10.8x → | 30: 10.6x ↗ |       |       |

|             |             |       |       |
|-------------|-------------|-------|-------|
| 31: 10.3x ↙ | 36: 10.2x ← | Serie | 103.7 |
| 32: 9.9 ←   | 37: 10.8x → |       |       |
| 33: 10.7x → | 38: 10.3x ↓ | Total | 418.8 |
| 34: 10.3x → | 39: 10.3x ← |       |       |
| 35: 10.5x ↓ | 40: 10.4x ↘ |       |       |

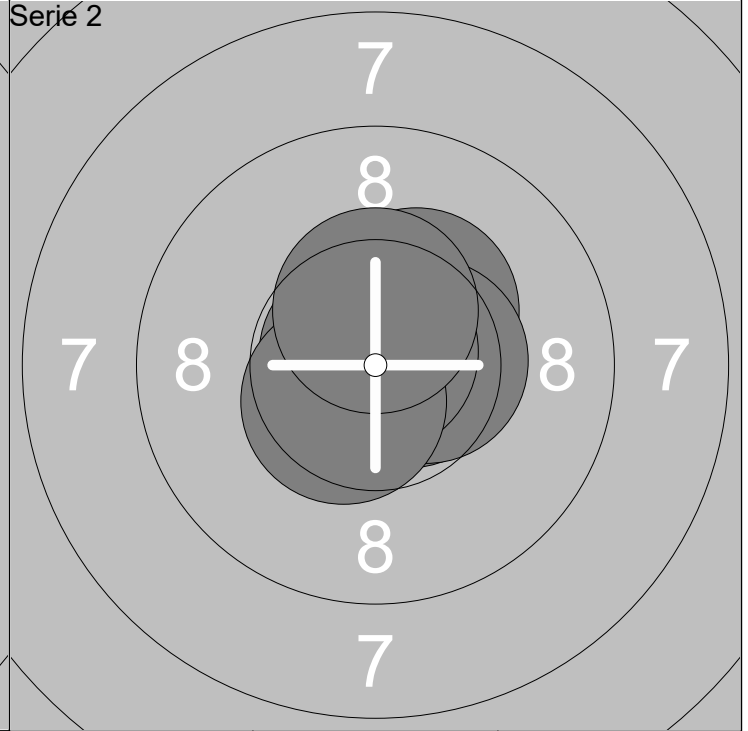
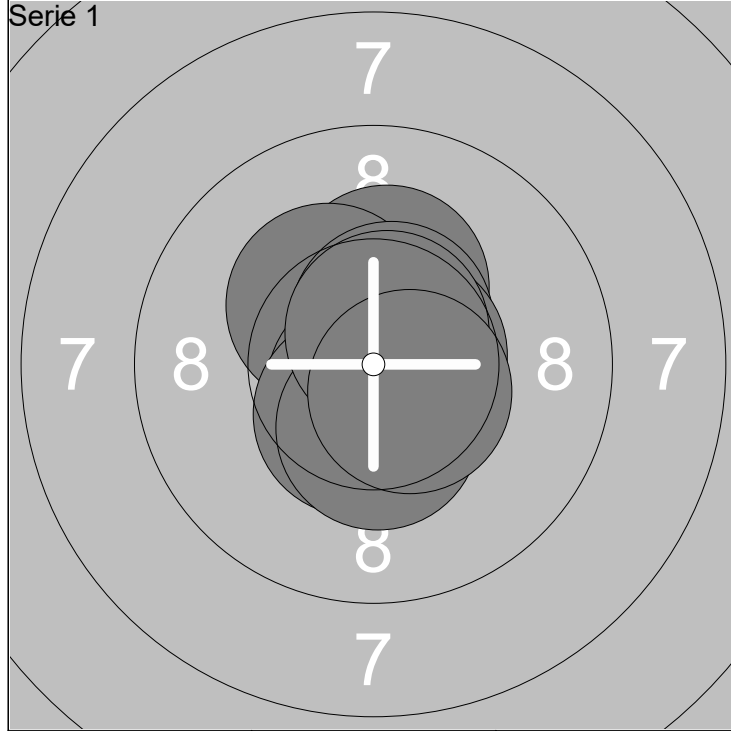

|            |             |       |       |
|------------|-------------|-------|-------|
| 1: 10.3x ↑ | 6: 10.7x →  | Serie | 105.8 |
| 2: 10.9x ↙ | 7: 10.5x ↓  |       |       |
| 3: 10.3x ↖ | 8: 10.4x ↓  | Total | 105.8 |
| 4: 10.6x ↗ | 9: 10.7x ↗  |       |       |
| 5: 10.8x ↓ | 10: 10.6x ↘ |       |       |

|             |             |       |       |
|-------------|-------------|-------|-------|
| 11: 10.6x → | 16: 10.7x ↗ | Serie | 106.0 |
| 12: 10.3x ↗ | 17: 10.5x → |       |       |
| 13: 10.8x ↖ | 18: 10.8x ↑ | Total | 211.8 |
| 14: 10.6x → | 19: 10.5x ↙ |       |       |
| 15: 10.7x → | 20: 10.5x ↑ |       |       |

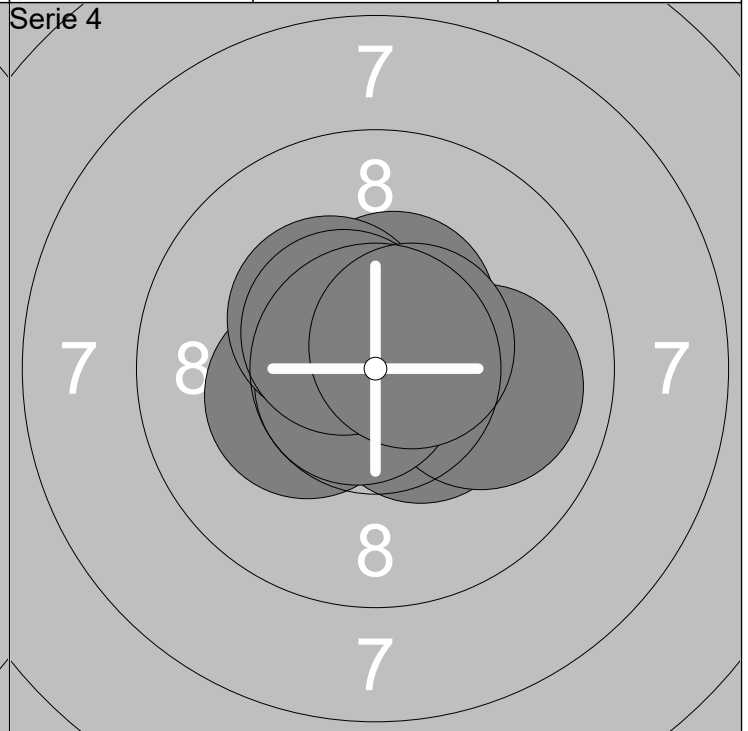
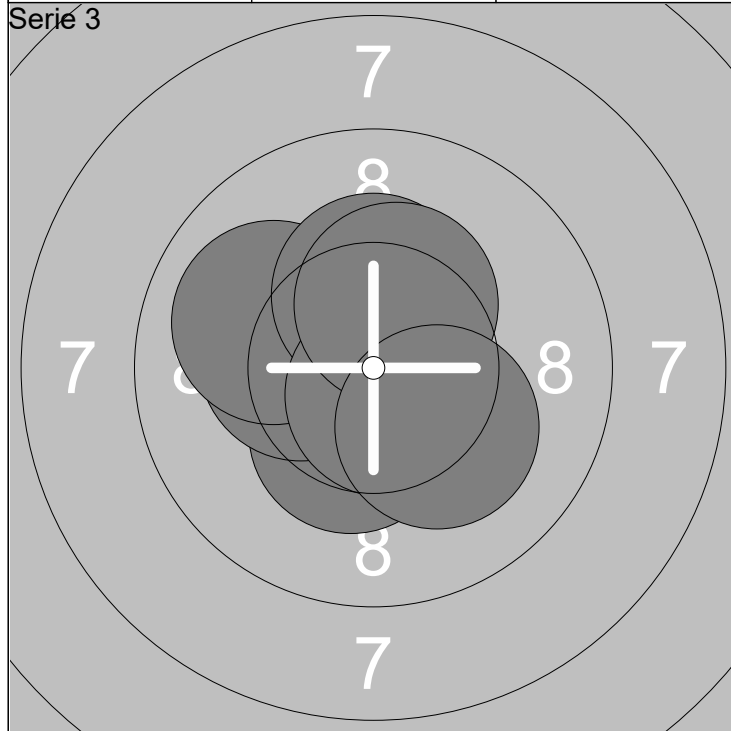

|             |             |       |       |
|-------------|-------------|-------|-------|
| 21: 10.8x ↓ | 26: 10.0 ↖  | Serie | 104.4 |
| 22: 10.4x ↓ | 27: 10.3x ↑ |       |       |
| 23: 10.5x ↖ | 28: 10.7x ↓ | Total | 316.2 |
| 24: 10.3x ← | 29: 10.4x ↗ |       |       |
| 25: 10.8x ↑ | 30: 10.2x ↘ |       |       |

|             |             |       |       |
|-------------|-------------|-------|-------|
| 31: 10.4x ↗ | 36: 10.3x ← | Serie | 104.6 |
| 32: 10.5x ↘ | 37: 10.8x ↙ |       |       |
| 33: 10.0 →  | 38: 10.3x ↖ | Total | 420.8 |
| 34: 10.6x ← | 39: 10.5x ↖ |       |       |
| 35: 10.6x ↖ | 40: 10.6x ↗ |       |       |

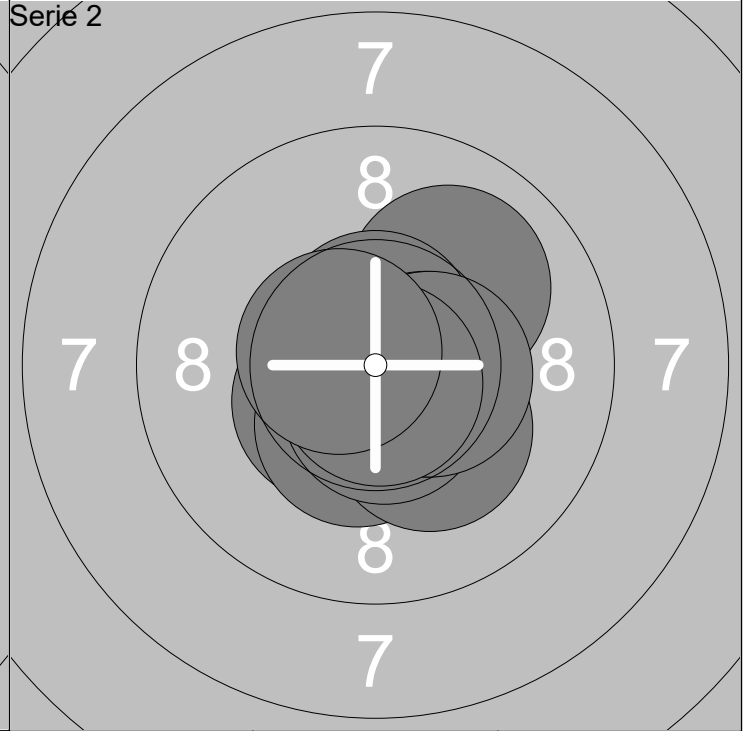
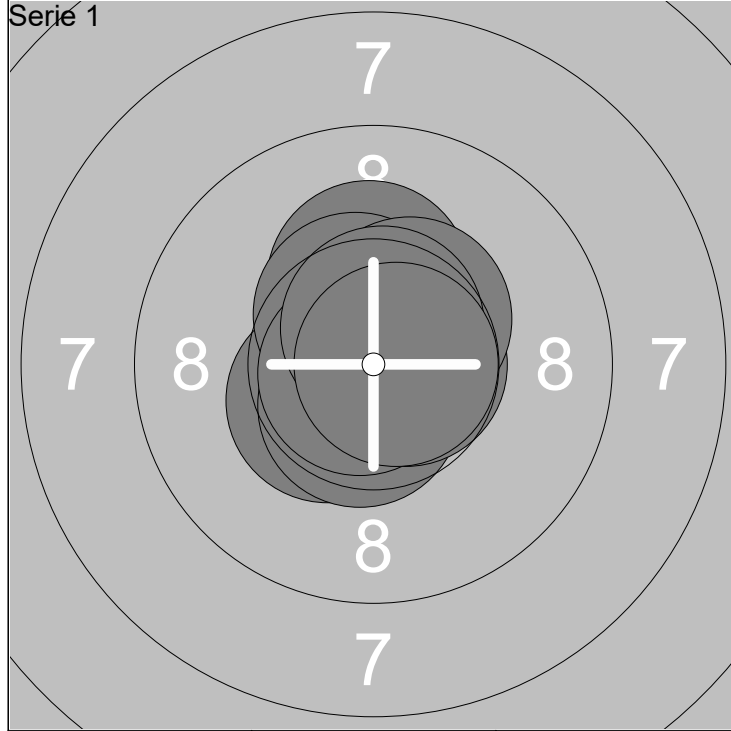

|            |             |       |       |
|------------|-------------|-------|-------|
| 1: 10.5x ↙ | 6: 10.7x ↗  | Serie | 105.8 |
| 2: 10.6x ↓ | 7: 10.8x ↙  |       |       |
| 3: 10.2x ↑ | 8: 10.5x ↗  | Total | 105.8 |
| 4: 10.5x ↗ | 9: 10.6x ↑  |       |       |
| 5: 10.7x → | 10: 10.7x → |       |       |

|             |             |       |       |
|-------------|-------------|-------|-------|
| 11: 10.5x ↙ | 16: 10.6x ↓ | Serie | 104.8 |
| 12: 10.0 ↗  | 17: 10.5x → |       |       |
| 13: 10.4x ↓ | 18: 10.5x → | Total | 210.6 |
| 14: 10.2x ↘ | 19: 10.8x ↓ |       |       |
| 15: 10.7x ↑ | 20: 10.6x ← |       |       |

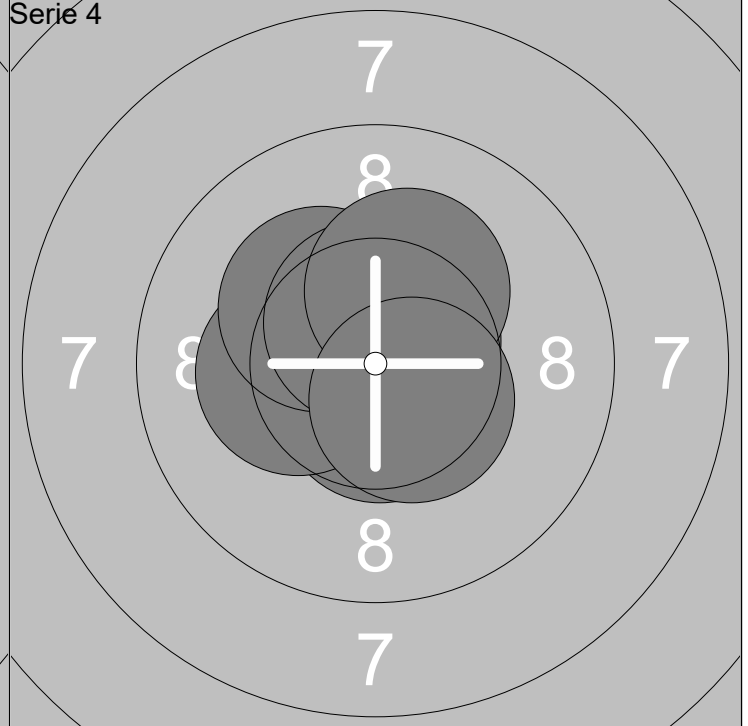
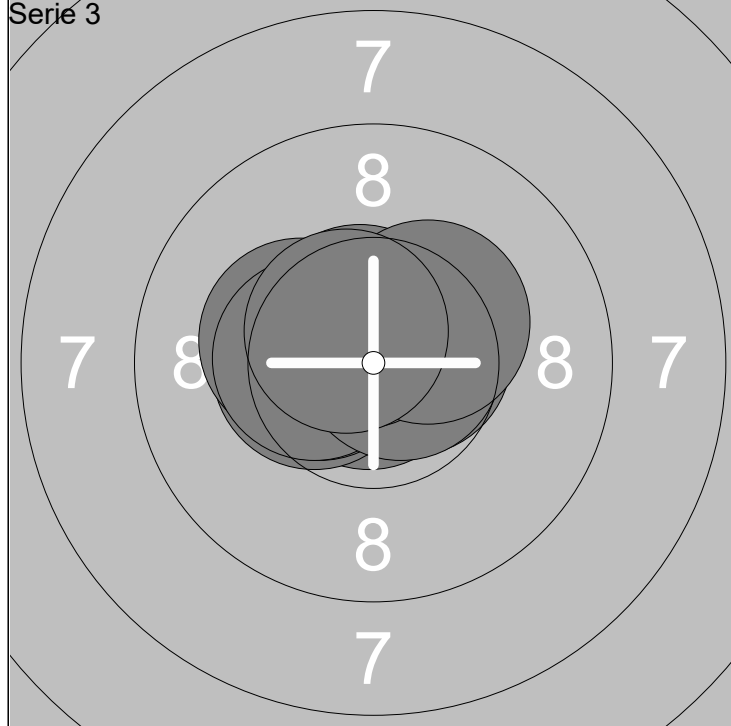

|             |             |       |       |
|-------------|-------------|-------|-------|
| 21: 10.6x → | 26: 10.4x ← | Serie | 105.4 |
| 22: 10.9x ↙ | 27: 10.7x → |       |       |
| 23: 10.4x ← | 28: 10.6x ↑ | Total | 316.0 |
| 24: 10.3x ← | 29: 10.4x ↗ |       |       |
| 25: 10.5x ← | 30: 10.6x ↖ |       |       |

|             |             |       |       |
|-------------|-------------|-------|-------|
| 31: 10.9x ↘ | 36: 10.3x ↖ | Serie | 105.5 |
| 32: 10.8x ↗ | 37: 10.7x ↗ |       |       |
| 33: 10.6x ↓ | 38: 10.6x ↑ | Total | 421.5 |
| 34: 10.3x ← | 39: 10.2x ↑ |       |       |
| 35: 10.6x ↑ | 40: 10.5x ↘ |       |       |

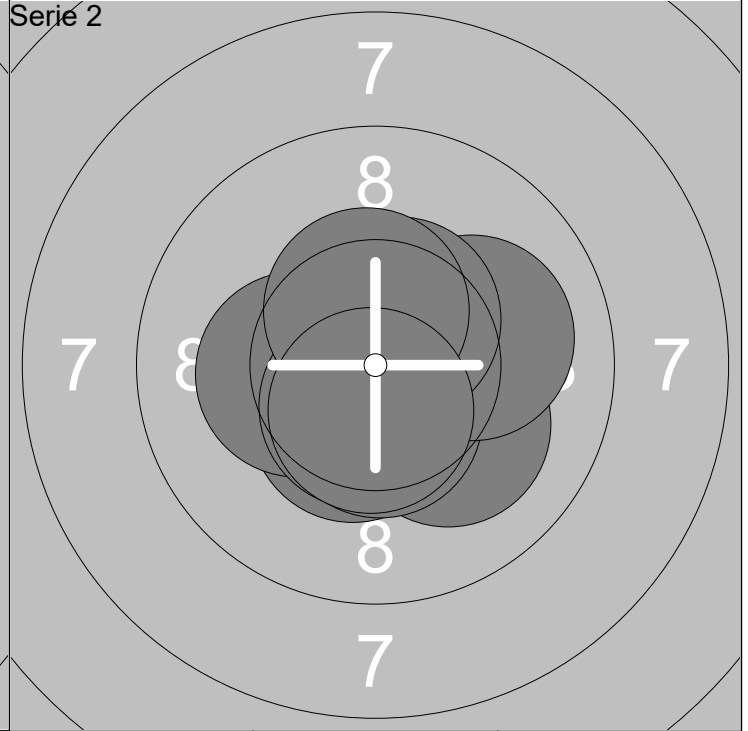
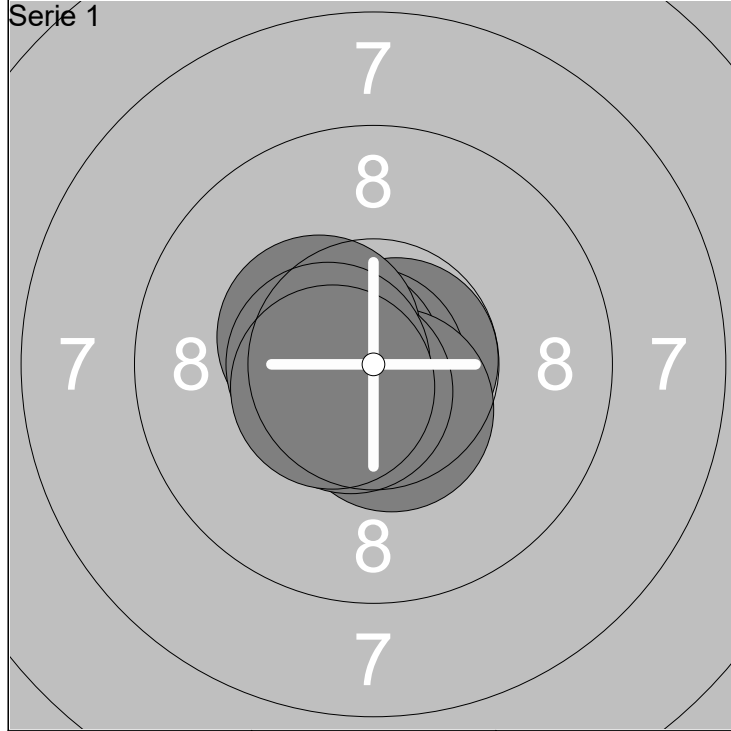

|            |             |       |       |
|------------|-------------|-------|-------|
| 1: 10.7x ↙ | 6: 10.5x ↓  | Serie | 106.2 |
| 2: 10.7x → | 7: 10.4x ↖  |       |       |
| 3: 10.9x ↙ | 8: 10.6x ↙  | Total | 106.2 |
| 4: 10.7x ← | 9: 10.5x ←  |       |       |
| 5: 10.7x ← | 10: 10.5x ↙ |       |       |

|             |             |       |       |
|-------------|-------------|-------|-------|
| 11: 10.4x ↓ | 16: 10.1 →  | Serie | 104.2 |
| 12: 10.3x ← | 17: 10.6x ↓ |       |       |
| 13: 10.1 ↘  | 18: 10.5x ↗ | Total | 210.4 |
| 14: 10.5x ↓ | 19: 10.5x ↑ |       |       |
| 15: 10.7x → | 20: 10.5x ↓ |       |       |

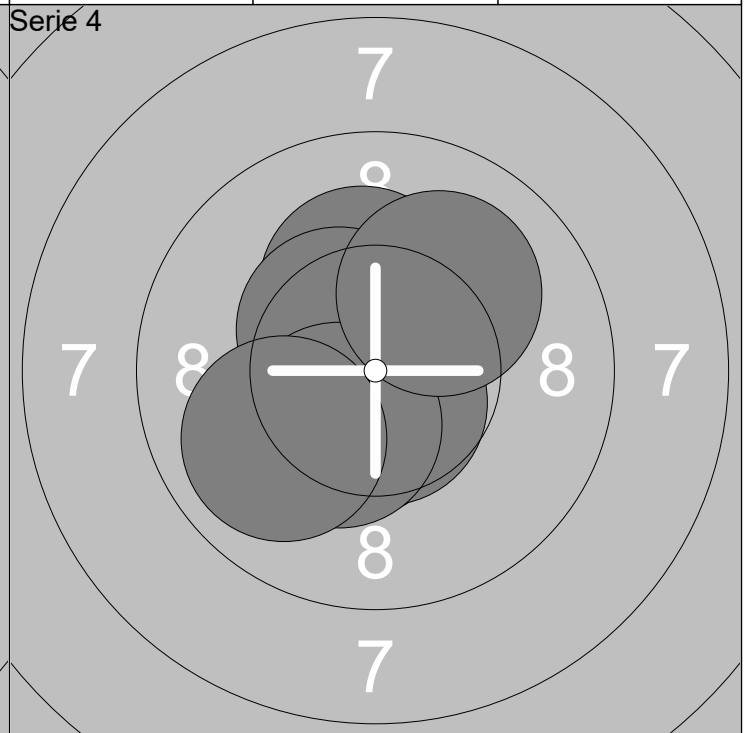
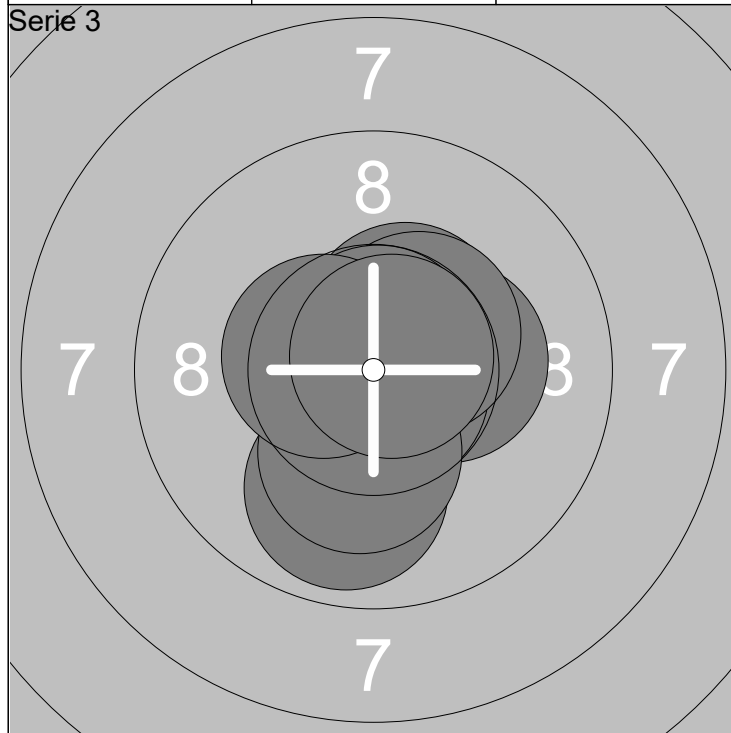

|             |             |       |       |
|-------------|-------------|-------|-------|
| 21: 10.5x ↗ | 26: 10.8x ↓ | Serie | 104.9 |
| 22: 10.3x → | 27: 10.2x ↓ |       |       |
| 23: 10.8x ↘ | 28: 10.8x ↑ | Total | 315.3 |
| 24: 10.4x ↗ | 29: 10.5x ↖ |       |       |
| 25: 9.9 ↓   | 30: 10.7x ↗ |       |       |

|             |             |       |       |
|-------------|-------------|-------|-------|
| 31: 10.5x ↓ | 36: 10.6x ↖ | Serie | 103.7 |
| 32: 10.4x ↗ | 37: 10.4x ↖ |       |       |
| 33: 10.2x ↑ | 38: 10.4x ↓ | Total | 419.0 |
| 34: 10.7x ↓ | 39: 10.1 ↗  |       |       |
| 35: 10.4x ↙ | 40: 10.0 ↙  |       |       |

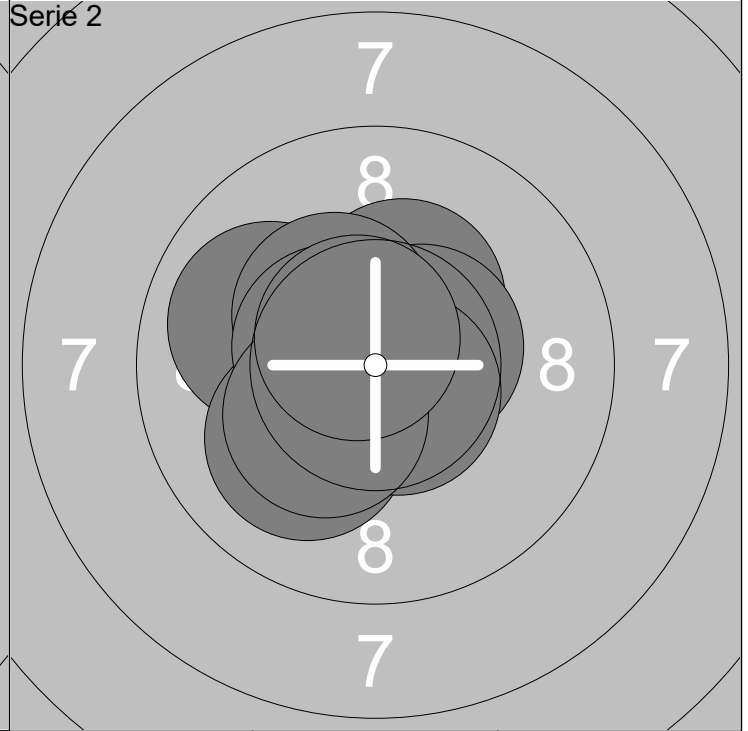
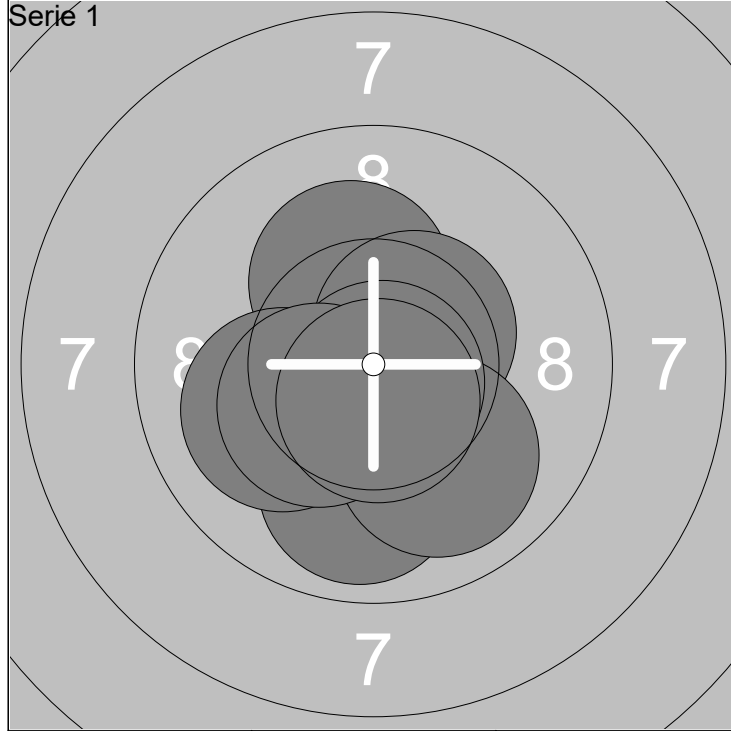

|            |             |       |       |
|------------|-------------|-------|-------|
| 1: 10.7x ↗ | 6: 10.0 ↓   | Serie | 103.4 |
| 2: 10.2x ↗ | 7: 10.8x ↓  |       |       |
| 3: 9.9 ↓   | 8: 10.1 ←   | Total | 103.4 |
| 4: 10.3x ↓ | 9: 10.3x ←  |       |       |
| 5: 10.5x ↗ | 10: 10.6x ↓ |       |       |

|             |             |       |       |
|-------------|-------------|-------|-------|
| 11: 10.0 ←  | 16: 10.4x ↗ | Serie | 104.2 |
| 12: 10.7x ↗ | 17: 10.5x ← |       |       |
| 13: 10.3x ↑ | 18: 10.7x ↓ | Total | 207.6 |
| 14: 10.1 ↓  | 19: 10.3x ← |       |       |
| 15: 10.5x → | 20: 10.7x ↗ |       |       |

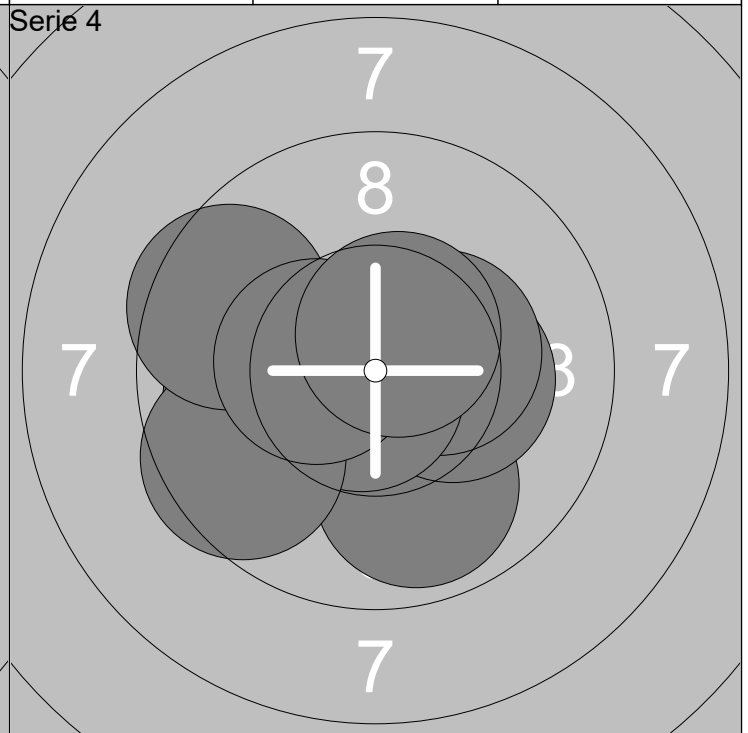
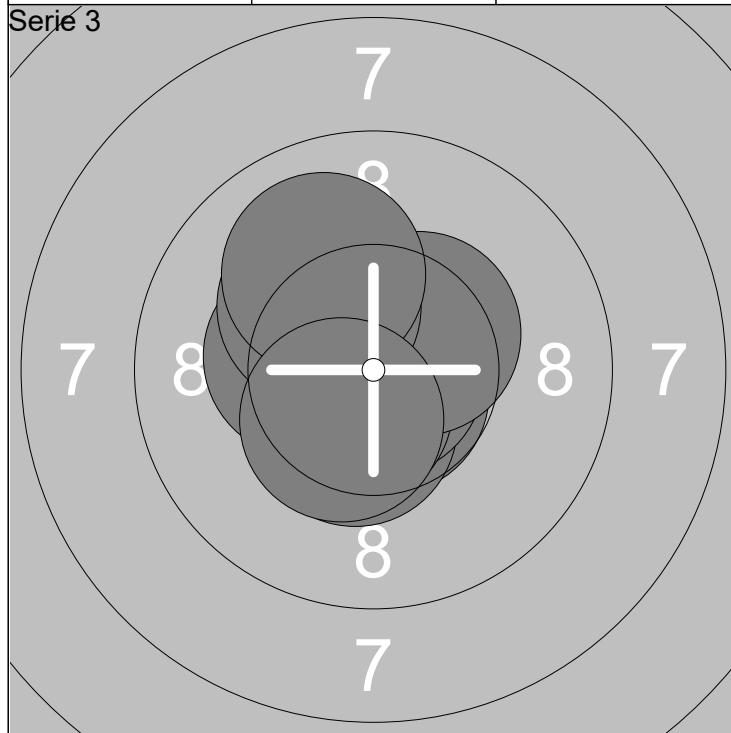

|             |             |       |       |
|-------------|-------------|-------|-------|
| 21: 10.7x ↓ | 26: 10.4x ← | Serie | 104.6 |
| 22: 10.4x ↓ | 27: 10.5x ↗ |       |       |
| 23: 10.9x → | 28: 10.2x ↗ | Total | 312.2 |
| 24: 10.5x ← | 29: 10.0 ↗  |       |       |
| 25: 10.6x ↓ | 30: 10.4x ↓ |       |       |

|             |             |       |       |
|-------------|-------------|-------|-------|
| 31: 9.9 ↓   | 36: 10.7x ↓ | Serie | 102.1 |
| 32: 10.3x → | 37: 9.6 ←   |       |       |
| 33: 10.0 ←  | 38: 9.6 ←   | Total | 414.3 |
| 34: 10.6x ↗ | 39: 10.4x ← |       |       |
| 35: 10.4x → | 40: 10.6x ↗ |       |       |

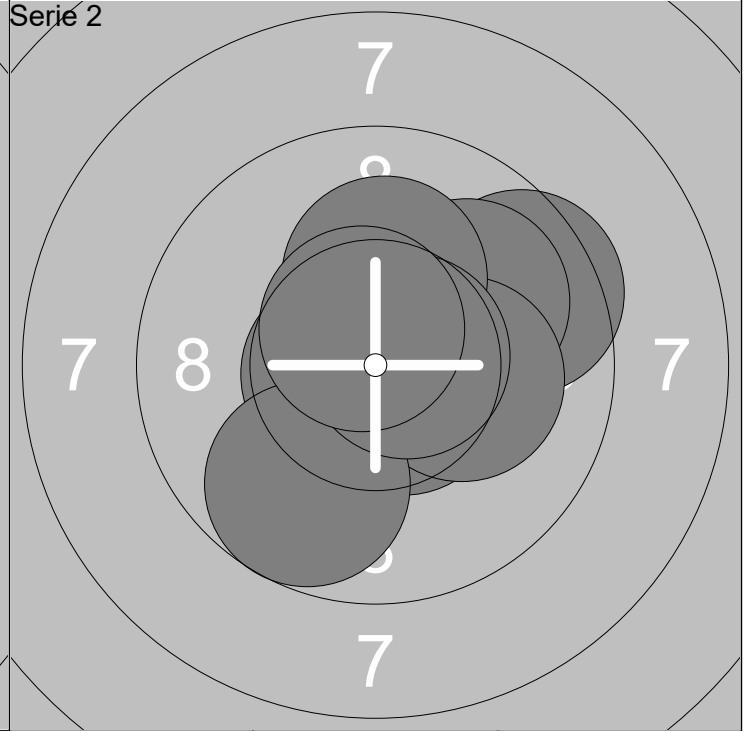
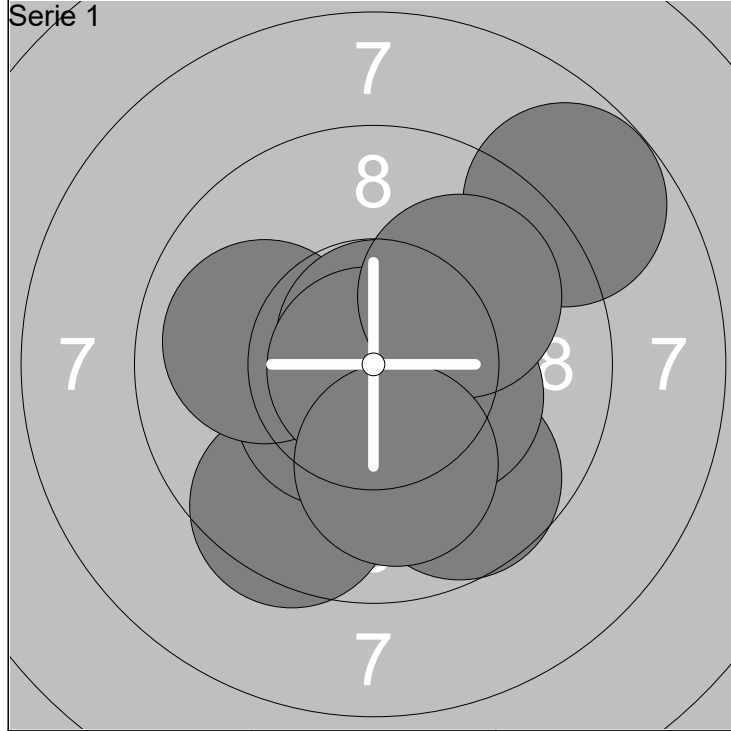

|            |            |       |       |
|------------|------------|-------|-------|
| 1: 9.7 ↘   | 6: 10.7x ↑ | Serie | 100.4 |
| 2: 9.5 ↘   | 7: 8.8 ↗   |       |       |
| 3: 10.5x ↘ | 8: 10.9x ↙ | Total | 100.4 |
| 4: 10.0 ←  | 9: 10.0 ↗  |       |       |
| 5: 10.3x → | 10: 10.0 ↓ |       |       |

|             |             |       |       |
|-------------|-------------|-------|-------|
| 11: 10.6x ↗ | 16: 10.2x ↑ | Serie | 102.8 |
| 12: 9.5 ↗   | 17: 10.7x ← |       |       |
| 13: 10.0 ↗  | 18: 9.7 ↘   | Total | 203.2 |
| 14: 10.6x ↘ | 19: 10.7x → |       |       |
| 15: 10.2x → | 20: 10.6x ↑ |       |       |

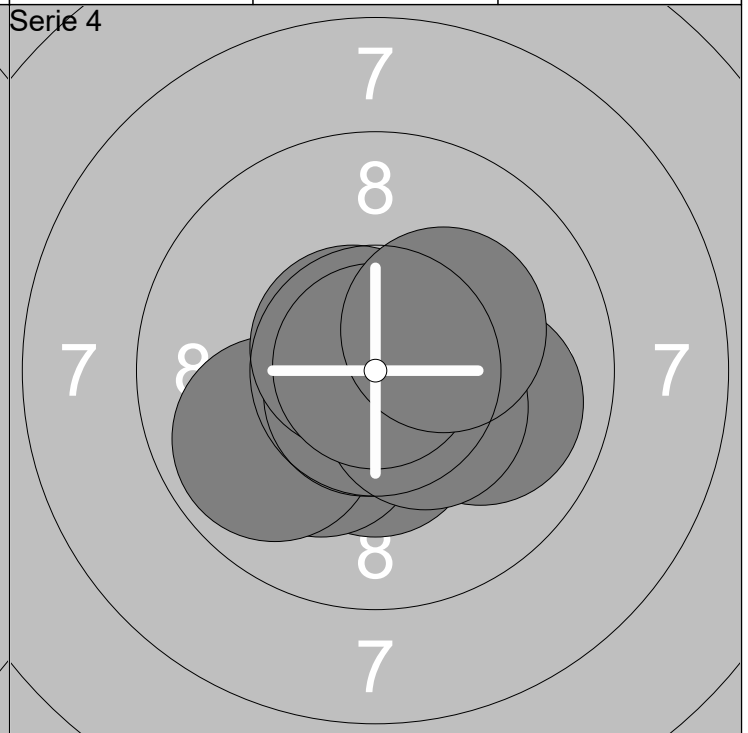
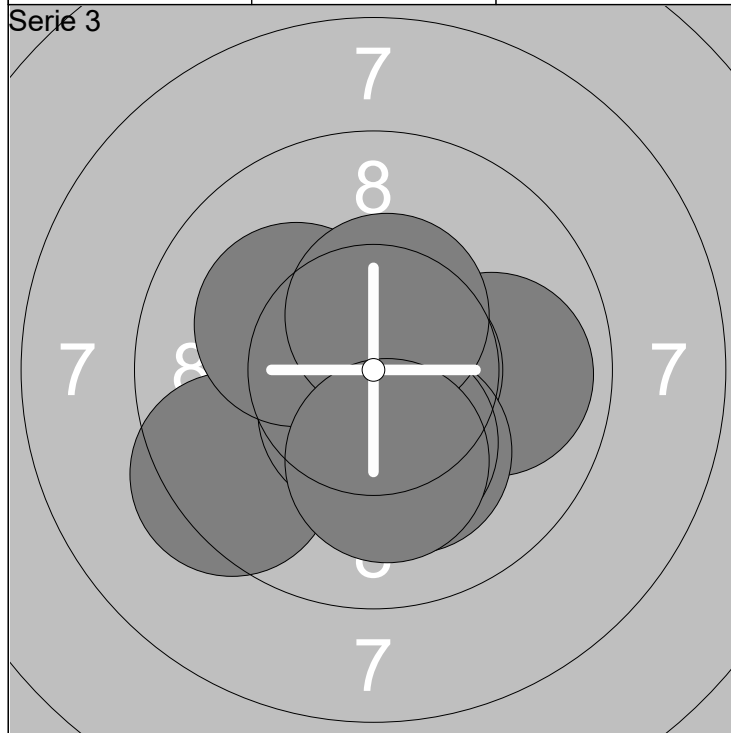

|             |             |       |       |
|-------------|-------------|-------|-------|
| 21: 10.7x ↗ | 26: 10.3x ↓ | Serie | 102.6 |
| 22: 9.4 ↙   | 27: 10.6x ↓ |       |       |
| 23: 9.9 →   | 28: 10.2x ↙ | Total | 305.8 |
| 24: 10.7x → | 29: 10.4x ↑ |       |       |
| 25: 10.2x ↓ | 30: 10.2x ↓ |       |       |

|             |             |       |       |
|-------------|-------------|-------|-------|
| 31: 10.7x ↓ | 36: 10.7x ↓ | Serie | 104.1 |
| 32: 10.4x ↓ | 37: 10.7x ↙ |       |       |
| 33: 10.2x ↙ | 38: 10.4x ↘ | Total | 409.9 |
| 34: 9.9 ↙   | 39: 10.9x ↑ |       |       |
| 35: 10.0 →  | 40: 10.2x ↗ |       |       |

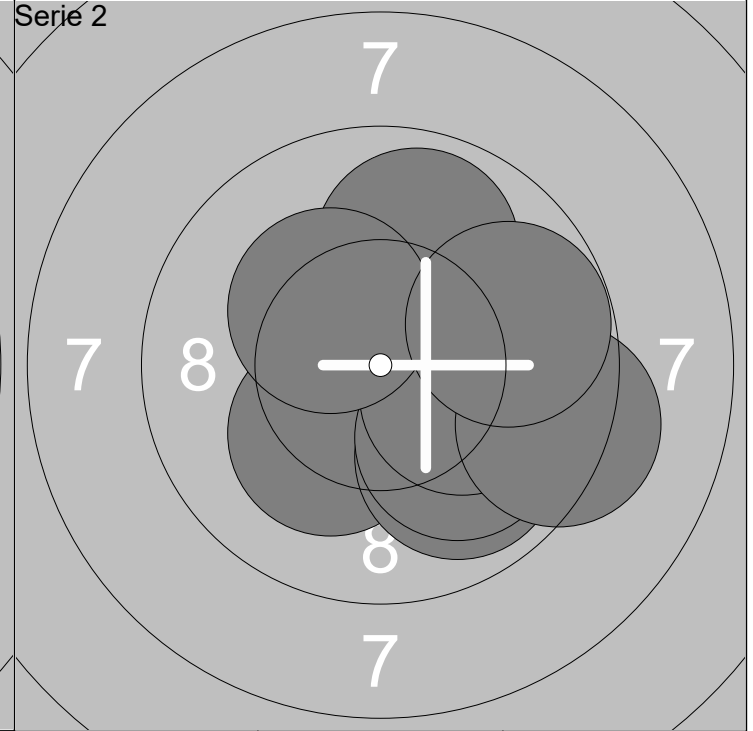
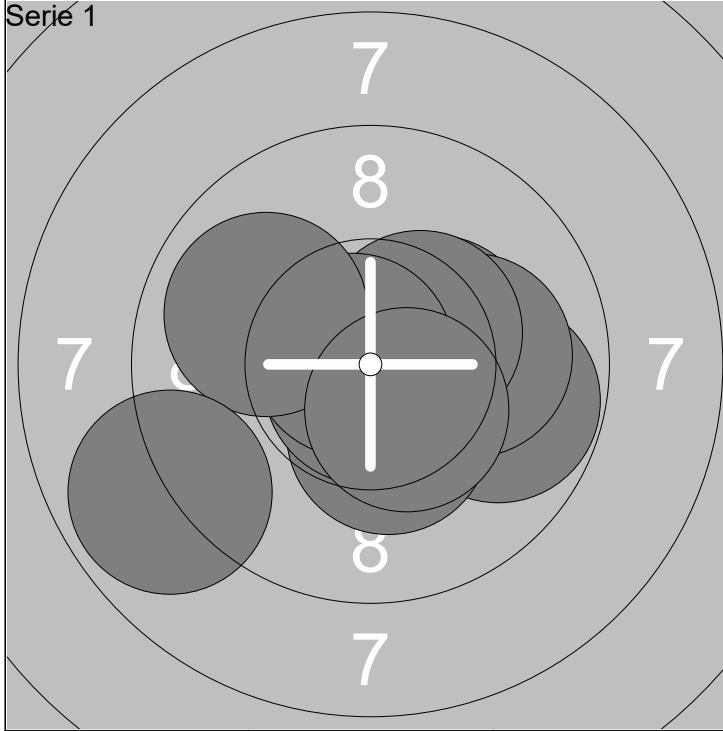

|            |             |                |
|------------|-------------|----------------|
| 1: 9.8 →   | 6: 10.5x ↗  | Serie<br>101.8 |
| 2: 10.3x ↓ | 7: 10.8x ↖  |                |
| 3: 10.3x → | 8: 9.9 ↖    | Total<br>101.8 |
| 4: 10.1 →  | 9: 8.9 ↖    |                |
| 5: 10.8x ↓ | 10: 10.4x ↓ |                |

|             |             |                |
|-------------|-------------|----------------|
| 11: 10.3x ↗ | 16: 10.0 ↓  | Serie<br>100.5 |
| 12: 10.6x → | 17: 10.2x → |                |
| 13: 10.2x ↘ | 18: 10.3x ↗ | Total<br>202.3 |
| 14: 9.9 ↓   | 19: 9.3 →   |                |
| 15: 9.9 ↗   | 20: 9.8 →   |                |

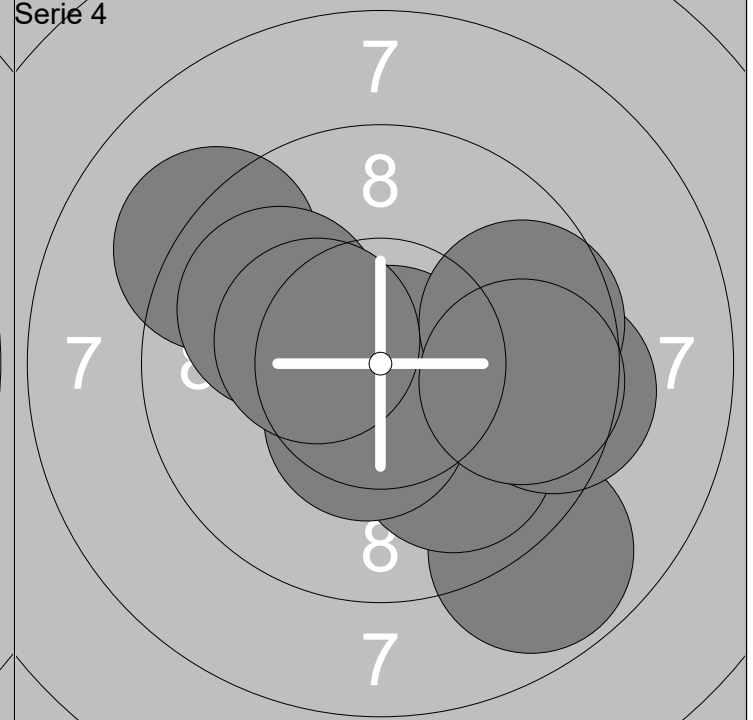
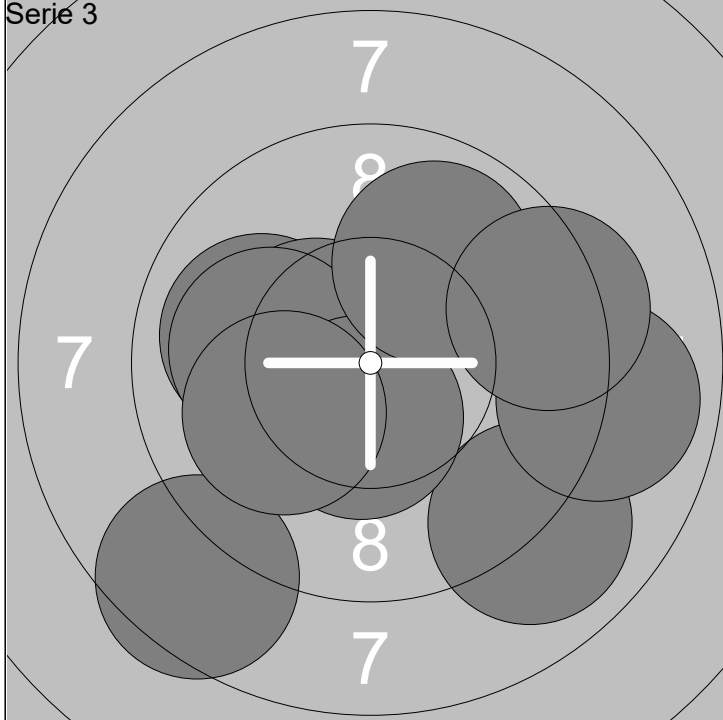

|             |             |                |
|-------------|-------------|----------------|
| 21: 10.0 ↖  | 26: 10.5x ↓ | Serie<br>96.6  |
| 22: 8.5 ↘   | 27: 9.9 ↗   |                |
| 23: 10.4x ↖ | 28: 8.9 →   | Total<br>298.9 |
| 24: 9.0 ↓   | 29: 10.1 ↖  |                |
| 25: 10.0 ↖  | 30: 9.3 →   |                |

|             |             |                |
|-------------|-------------|----------------|
| 31: 10.9x → | 36: 10.4x ↓ | Serie<br>98.4  |
| 32: 8.8 ↓   | 37: 10.0 ↖  |                |
| 33: 10.0 ↘  | 38: 9.6 →   | Total<br>397.3 |
| 34: 9.2 ↗   | 39: 9.7 →   |                |
| 35: 9.4 →   | 40: 10.4x ↖ |                |

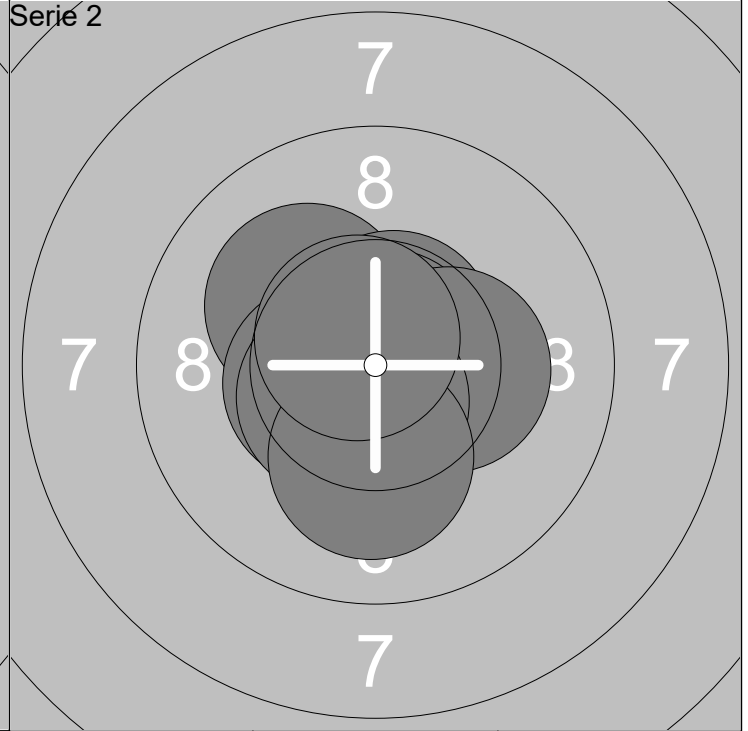
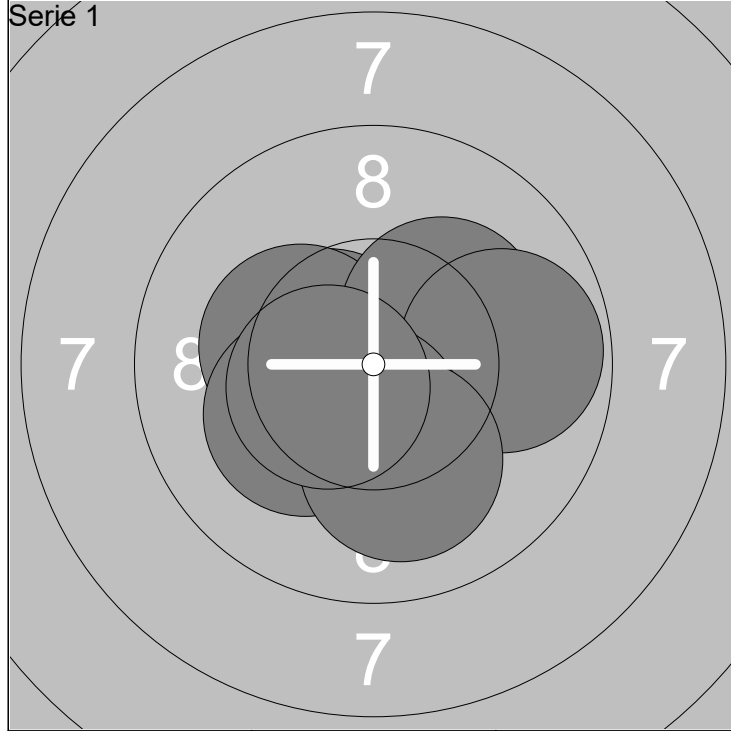

|            |             |                |
|------------|-------------|----------------|
| 1: 10.5x ↙ | 6: 10.3x ↙  | Serie<br>102.7 |
| 2: 10.3x ↙ | 7: 10.4x ↓  |                |
| 3: 10.2x ↗ | 8: 10.2x ↙  | Total<br>102.7 |
| 4: 9.8 →   | 9: 10.1 ↓   |                |
| 5: 10.4x ↙ | 10: 10.5x ↙ |                |

|             |             |                |
|-------------|-------------|----------------|
| 11: 10.1 ↖  | 16: 10.3x → | Serie<br>104.8 |
| 12: 10.6x ↗ | 17: 10.6x ↓ |                |
| 13: 10.6x ↗ | 18: 10.5x ↙ | Total<br>207.5 |
| 14: 10.5x ↙ | 19: 10.1 ↓  |                |
| 15: 10.8x ↗ | 20: 10.7x ↖ |                |

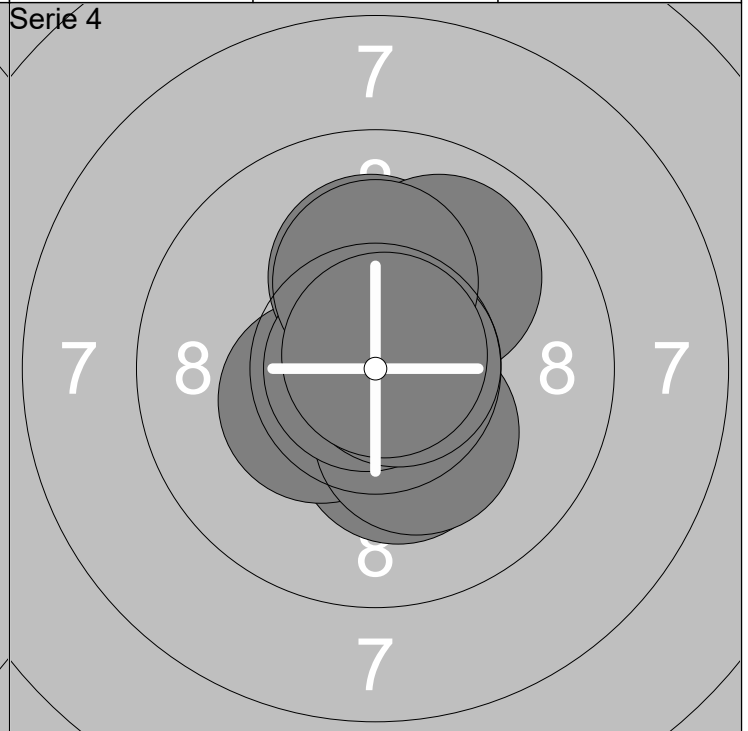
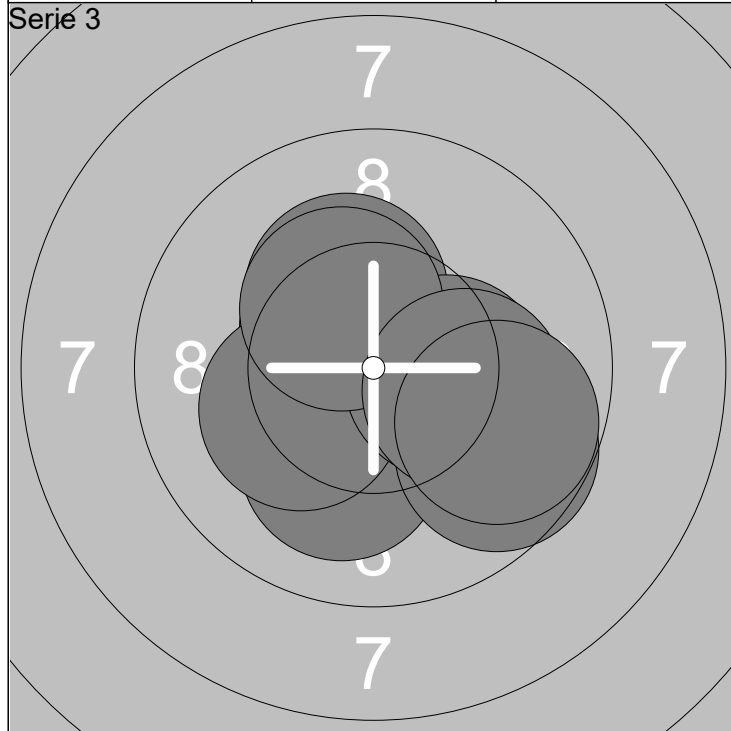

|             |             |                |
|-------------|-------------|----------------|
| 21: 10.7x ↖ | 26: 10.3x → | Serie<br>102.1 |
| 22: 10.5x ↖ | 27: 10.4x ↗ |                |
| 23: 10.3x ↗ | 28: 9.7 ↘   | Total<br>309.6 |
| 24: 10.1 ↓  | 29: 10.1 →  |                |
| 25: 10.2x ↙ | 30: 9.8 ↘   |                |

|             |             |                |
|-------------|-------------|----------------|
| 31: 10.3x ↓ | 36: 10.2x ↗ | Serie<br>104.0 |
| 32: 10.4x ↙ | 37: 10.0 ↗  |                |
| 33: 10.3x ↓ | 38: 10.7x → | Total<br>413.6 |
| 34: 10.2x ↑ | 39: 10.2x ↑ |                |
| 35: 10.9x ← | 40: 10.8x ↗ |                |



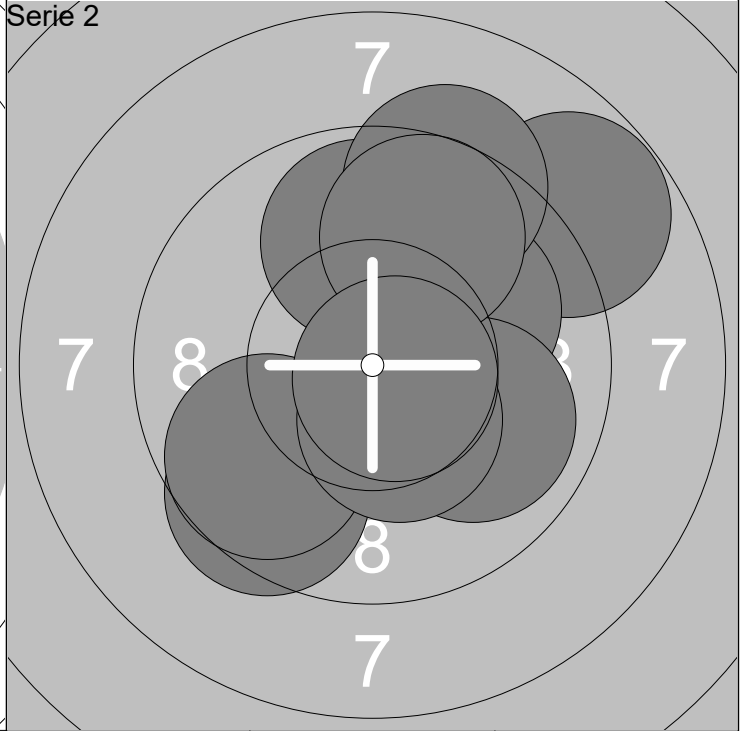
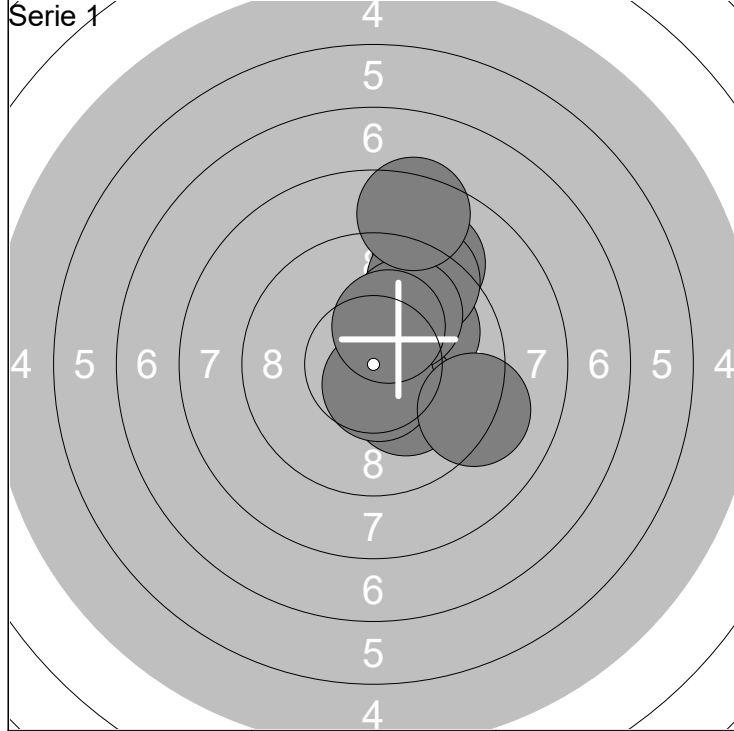

|            |             |       |      |
|------------|-------------|-------|------|
| 1: 9.1 ↗   | 6: 10.0 ↗   | Serie | 97.4 |
| 2: 10.2x ↗ | 7: 8.4 ↗    |       |      |
| 3: 10.0 ↗  | 8: 10.6x ↓  | Total | 97.4 |
| 4: 10.2x ↘ | 9: 9.2 ↘    |       |      |
| 5: 9.4 ↗   | 10: 10.3x ↗ |       |      |

|            |             |       |       |
|------------|-------------|-------|-------|
| 11: 8.8 ↗  | 16: 10.0 ↘  | Serie | 98.0  |
| 12: 9.5 ↘  | 17: 9.2 ↗   |       |       |
| 13: 9.7 ↘  | 18: 9.8 ↗   | Total | 195.4 |
| 14: 10.0 ↗ | 19: 10.4x ↓ |       |       |
| 15: 9.9 ↗  | 20: 10.7x ↘ |       |       |

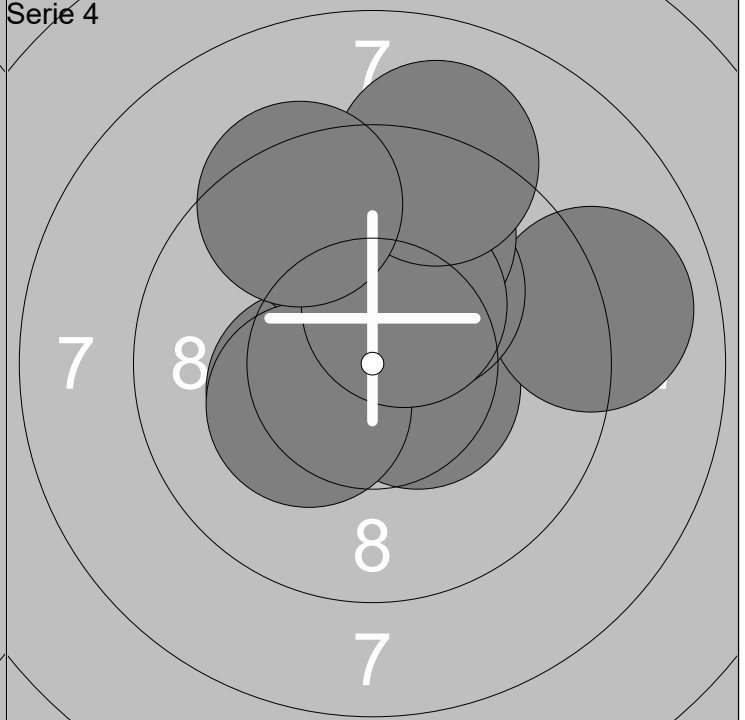
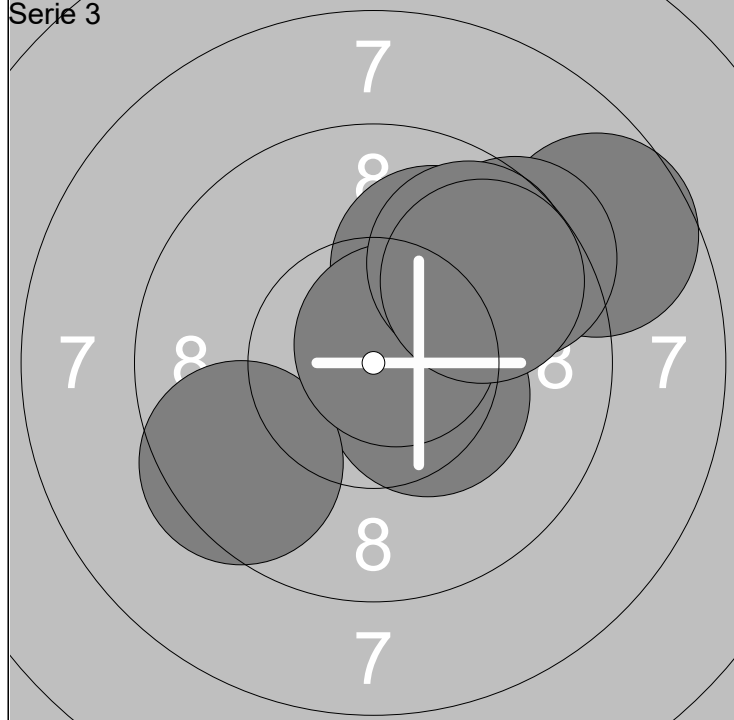

|             |             |       |       |
|-------------|-------------|-------|-------|
| 21: 10.7x → | 26: 10.0 ↗  | Serie | 99.4  |
| 22: 8.7 ↗   | 27: 10.7x ↗ |       |       |
| 23: 10.6x → | 28: 9.4 ↗   | Total | 294.8 |
| 24: 10.4x ↘ | 29: 9.7 ↗   |       |       |
| 25: 9.5 ↘   | 30: 9.7 ↗   |       |       |

|             |             |       |       |
|-------------|-------------|-------|-------|
| 31: 10.5x ↘ | 36: 9.8 ↗   | Serie | 98.8  |
| 32: 9.0 →   | 37: 10.3x ↘ |       |       |
| 33: 10.4x ↙ | 38: 10.4x ↗ | Total | 393.6 |
| 34: 10.2x ↗ | 39: 9.1 ↗   |       |       |
| 35: 9.7 ↗   | 40: 9.4 ↗   |       |       |

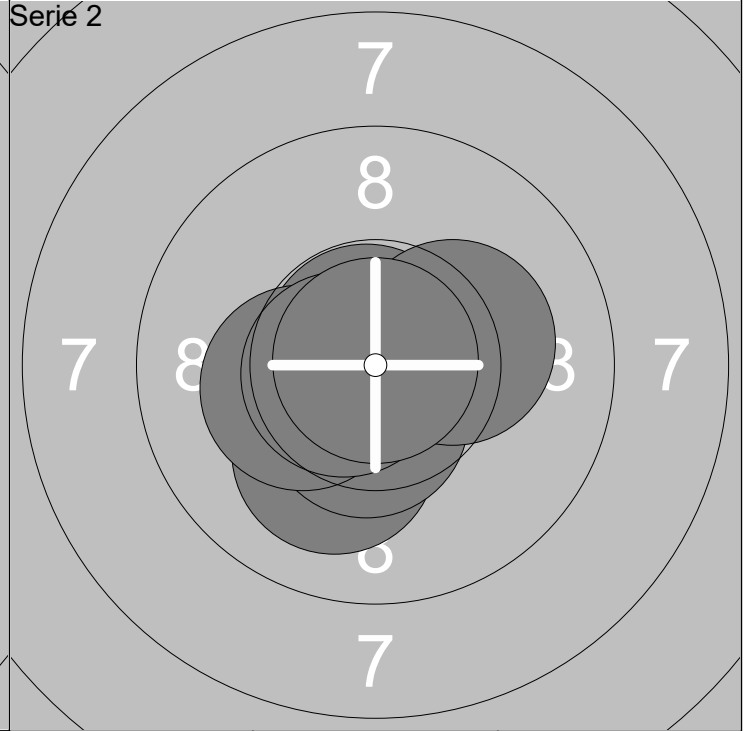
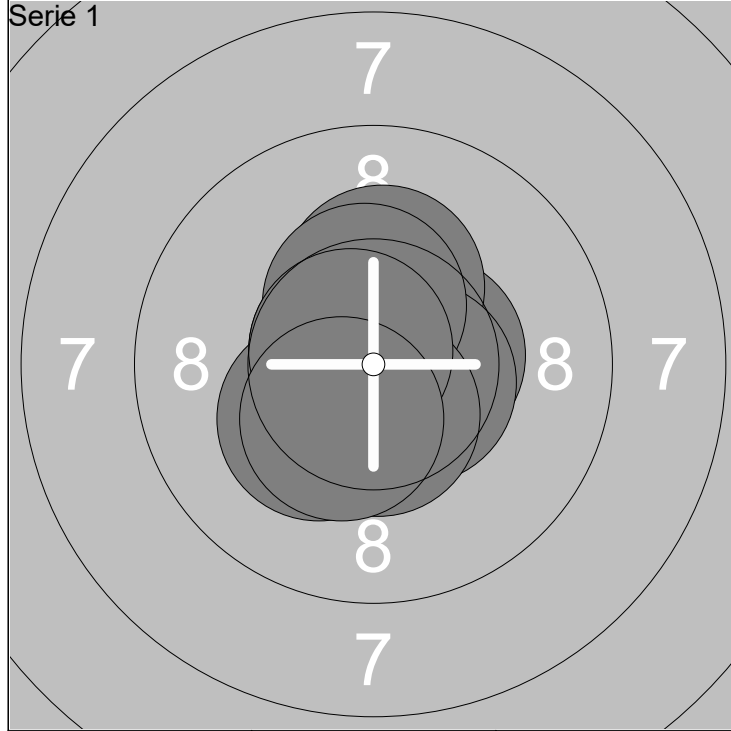

|            |             |       |       |
|------------|-------------|-------|-------|
| 1: 10.5x → | 6: 10.4x ↑  | Serie | 105.1 |
| 2: 10.7x ↘ | 7: 10.5x ↓  |       |       |
| 3: 10.7x ↖ | 8: 10.3x ↙  | Total | 105.1 |
| 4: 10.3x ↑ | 9: 10.7x ↗  |       |       |
| 5: 10.6x → | 10: 10.4x ↘ |       |       |

|             |             |       |       |
|-------------|-------------|-------|-------|
| 11: 10.8x ↗ | 16: 10.8x ↖ | Serie | 105.9 |
| 12: 10.7x ↘ | 17: 10.3x ← |       |       |
| 13: 10.9x ↖ | 18: 10.6x ← | Total | 211.0 |
| 14: 10.1 ↓  | 19: 10.3x → |       |       |
| 15: 10.5x ↓ | 20: 10.9x ↑ |       |       |

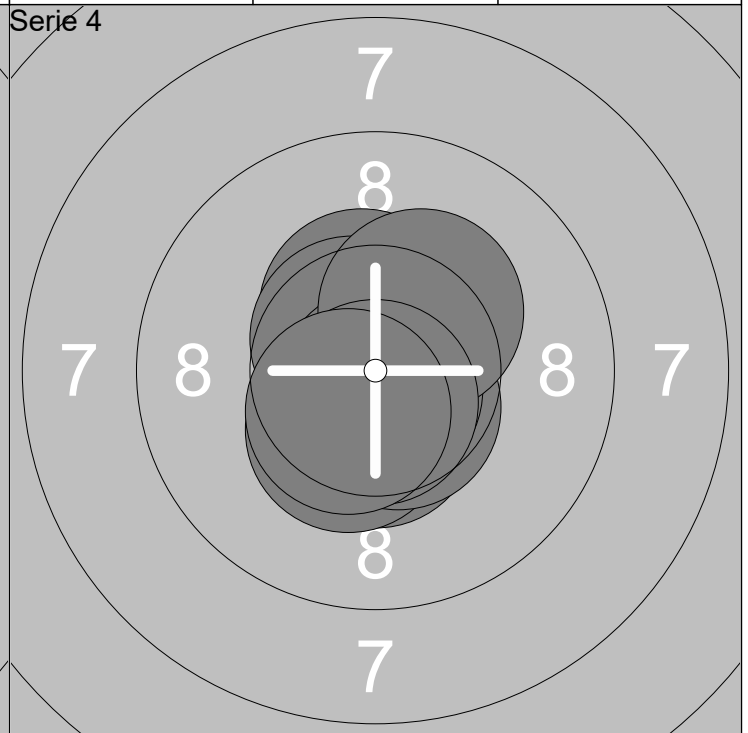
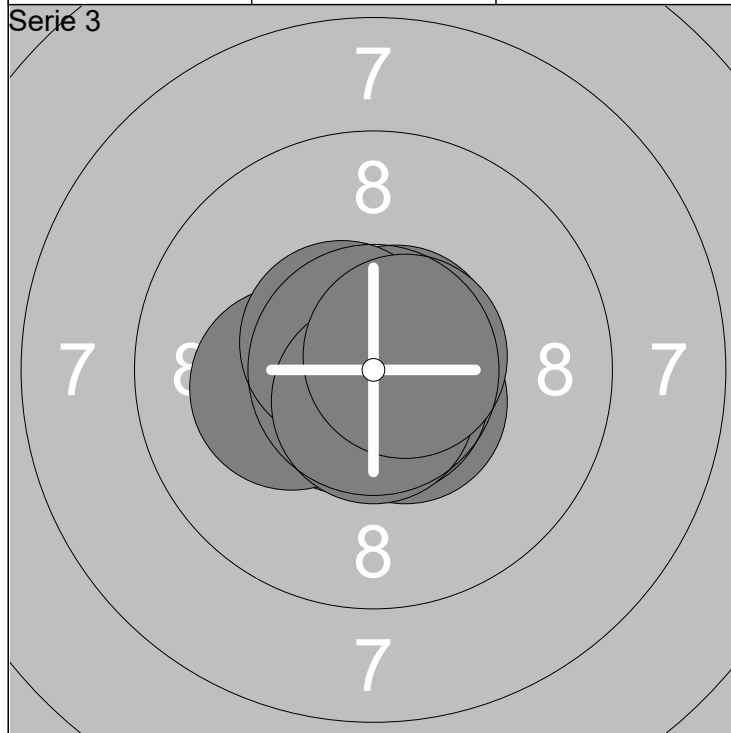

|             |             |       |       |
|-------------|-------------|-------|-------|
| 21: 10.7x ↗ | 26: 10.7x ↖ | Serie | 106.2 |
| 22: 10.7x ↘ | 27: 10.2x ← |       |       |
| 23: 10.7x → | 28: 10.6x ↖ | Total | 317.2 |
| 24: 10.6x ↘ | 29: 10.7x ↓ |       |       |
| 25: 10.7x ↘ | 30: 10.6x → |       |       |

|             |             |       |       |
|-------------|-------------|-------|-------|
| 31: 10.5x ↓ | 36: 10.6x ↖ | Serie | 105.5 |
| 32: 10.4x ↓ | 37: 10.8x ↓ |       |       |
| 33: 10.6x ↘ | 38: 10.3x ↗ | Total | 422.7 |
| 34: 10.4x ↑ | 39: 10.7x ↓ |       |       |
| 35: 10.7x ↖ | 40: 10.5x ↘ |       |       |

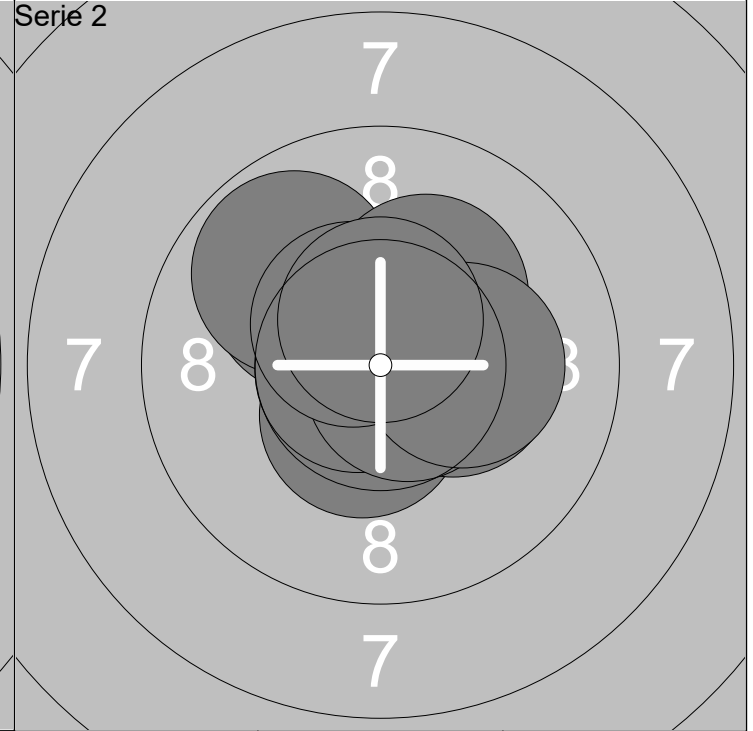
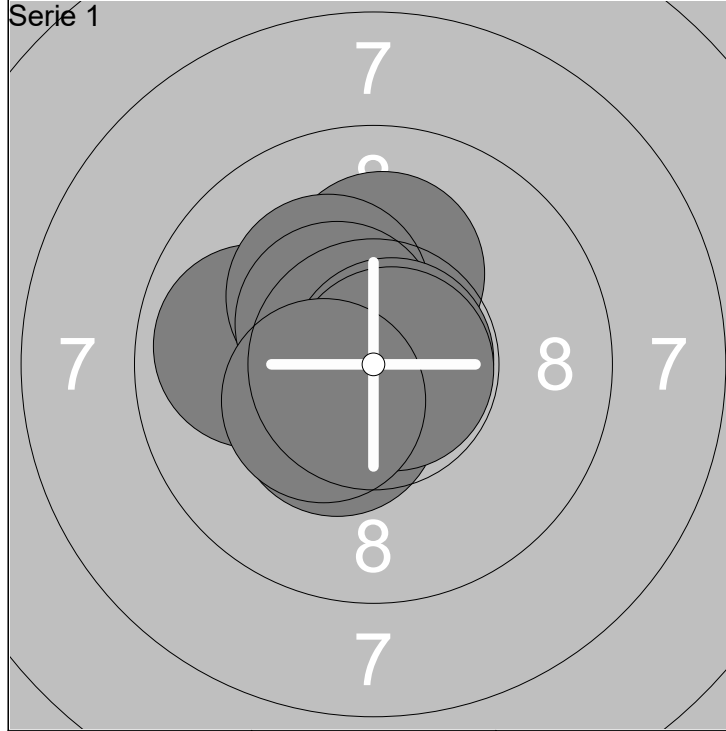

|            |             |       |       |
|------------|-------------|-------|-------|
| 1: 10.6x ↑ | 6: 10.2x ↖  | Serie | 104.4 |
| 2: 10.4x ↙ | 7: 10.5x ↖  |       |       |
| 3: 10.6x ↖ | 8: 10.8x →  | Total | 104.4 |
| 4: 9.9 ←   | 9: 10.8x →  |       |       |
| 5: 10.2x ↑ | 10: 10.4x ↙ |       |       |

|             |             |       |       |
|-------------|-------------|-------|-------|
| 11: 10.1 ↖  | 16: 10.2x ↗ | Serie | 103.6 |
| 12: 10.5x ↙ | 17: 10.7x → |       |       |
| 13: 9.8 ↖   | 18: 10.5x ↖ | Total | 208.0 |
| 14: 10.3x → | 19: 10.2x → |       |       |
| 15: 10.7x ← | 20: 10.6x ↑ |       |       |

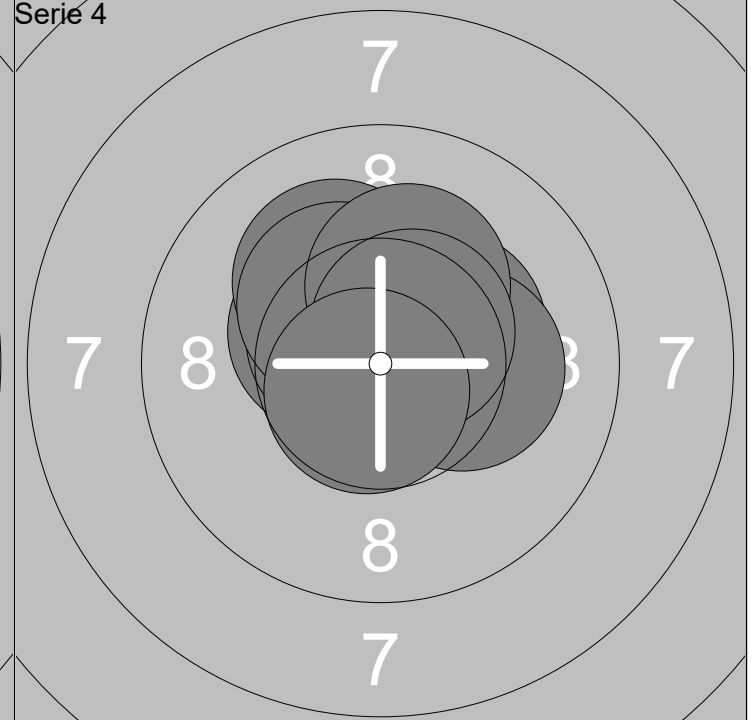
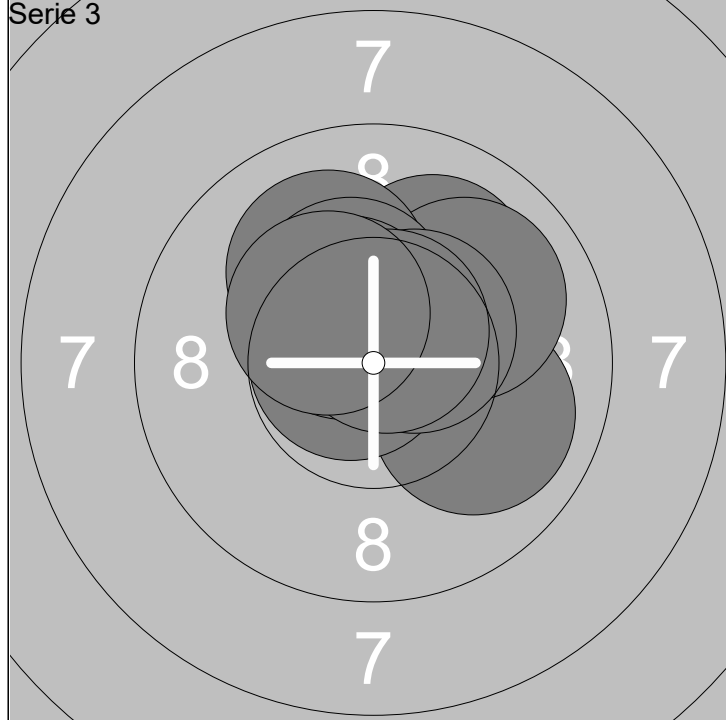

|             |             |       |       |
|-------------|-------------|-------|-------|
| 21: 10.0 →  | 26: 10.3x ↗ | Serie | 103.1 |
| 22: 10.0 ↗  | 27: 10.5x ↗ |       |       |
| 23: 10.0 ↗  | 28: 10.5x ↖ | Total | 311.1 |
| 24: 10.1 ↖  | 29: 10.6x ↗ |       |       |
| 25: 10.7x ← | 30: 10.4x ↖ |       |       |

|             |             |       |       |
|-------------|-------------|-------|-------|
| 31: 10.4x ↖ | 36: 10.3x ↖ | Serie | 104.1 |
| 32: 10.1 ↖  | 37: 10.2x → |       |       |
| 33: 10.8x ↖ | 38: 10.2x ↗ | Total | 415.2 |
| 34: 10.3x ↗ | 39: 10.5x ↗ |       |       |
| 35: 10.6x ↖ | 40: 10.7x ↙ |       |       |

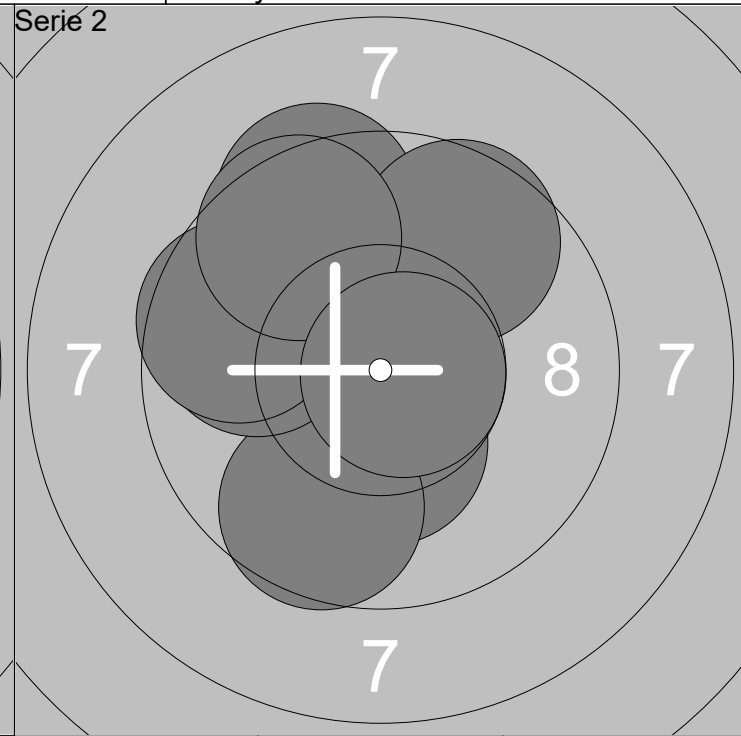
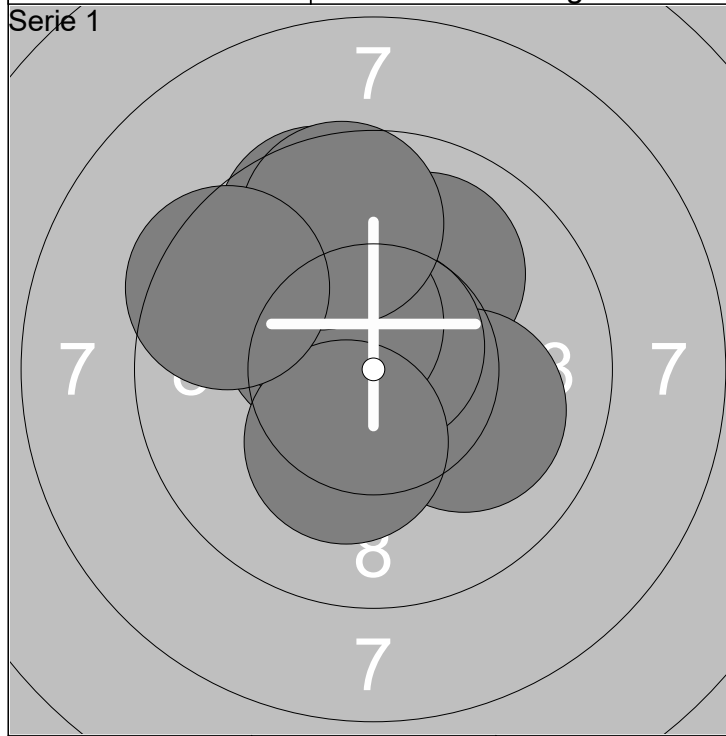

|            |            |       |       |
|------------|------------|-------|-------|
| 1: 10.0 ↗  | 6: 10.4x ↖ | Serie | 101.2 |
| 2: 10.6x ↗ | 7: 9.6 ↗   |       |       |
| 3: 10.1 →  | 8: 10.3x ↓ | Total | 101.2 |
| 4: 10.4x ↗ | 9: 9.6 ↗   |       |       |
| 5: 10.7x ↗ | 10: 9.5 ↖  |       |       |

|             |             |       |       |
|-------------|-------------|-------|-------|
| 11: 9.4 ↗   | 16: 9.6 ↗   | Serie | 98.7  |
| 12: 10.0 ↖  | 17: 9.8 ↖   |       |       |
| 13: 10.1 ↗  | 18: 9.6 ↖   | Total | 199.9 |
| 14: 10.3x ↓ | 19: 9.6 ↗   |       |       |
| 15: 9.6 ↓   | 20: 10.7x → |       |       |

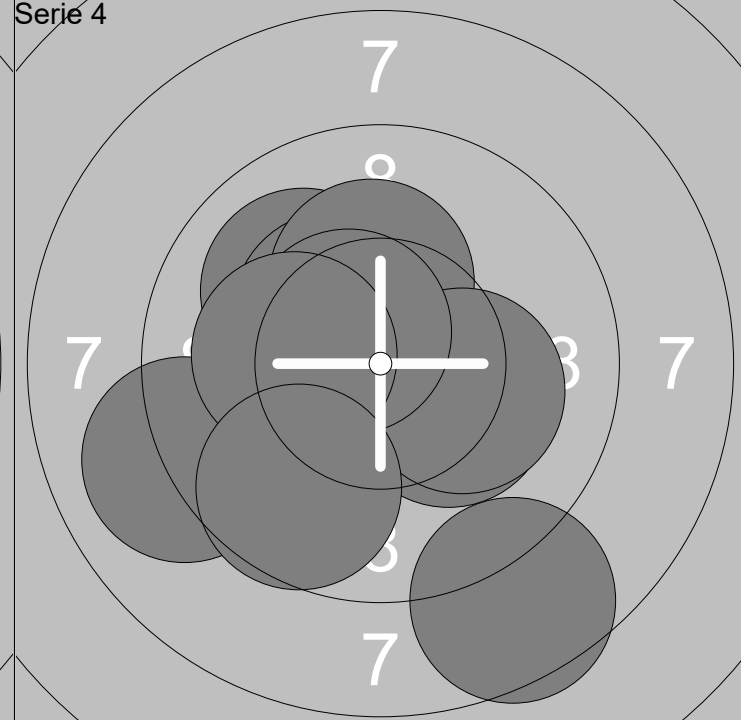
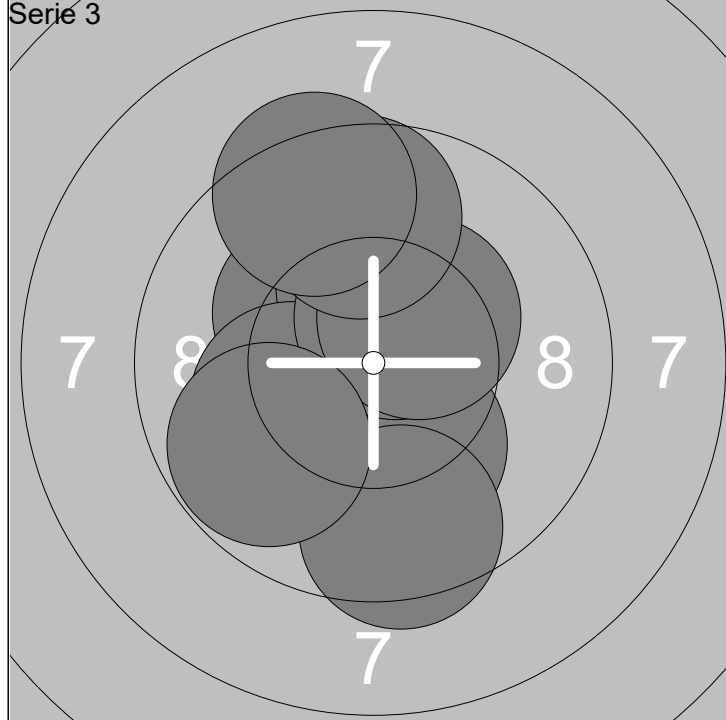

|             |             |       |       |
|-------------|-------------|-------|-------|
| 21: 10.3x ↖ | 26: 10.5x ↗ | Serie | 100.3 |
| 22: 10.3x ↗ | 27: 10.4x ↗ |       |       |
| 23: 10.2x ↖ | 28: 9.7 ↗   | Total | 300.2 |
| 24: 10.2x ↓ | 29: 9.4 ↗   |       |       |
| 25: 9.5 ↓   | 30: 9.8 ↖   |       |       |

|             |             |       |       |
|-------------|-------------|-------|-------|
| 31: 10.0 ↖  | 36: 10.2x ↖ | Serie | 99.0  |
| 32: 10.4x ↖ | 37: 10.2x → |       |       |
| 33: 10.2x ↗ | 38: 10.6x ↖ | Total | 399.2 |
| 34: 9.0 ↖   | 39: 10.2x ↖ |       |       |
| 35: 8.6 ↓   | 40: 9.6 ↓   |       |       |

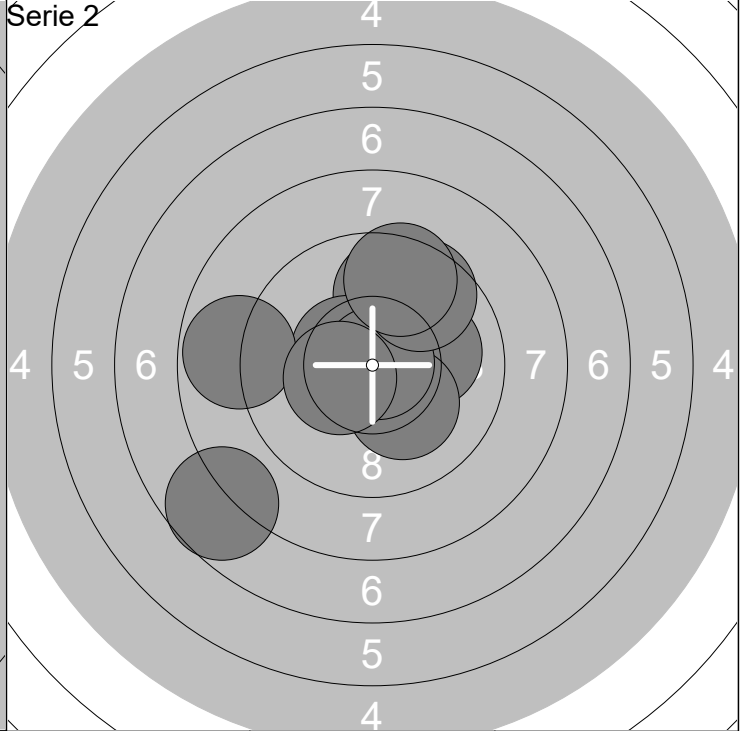
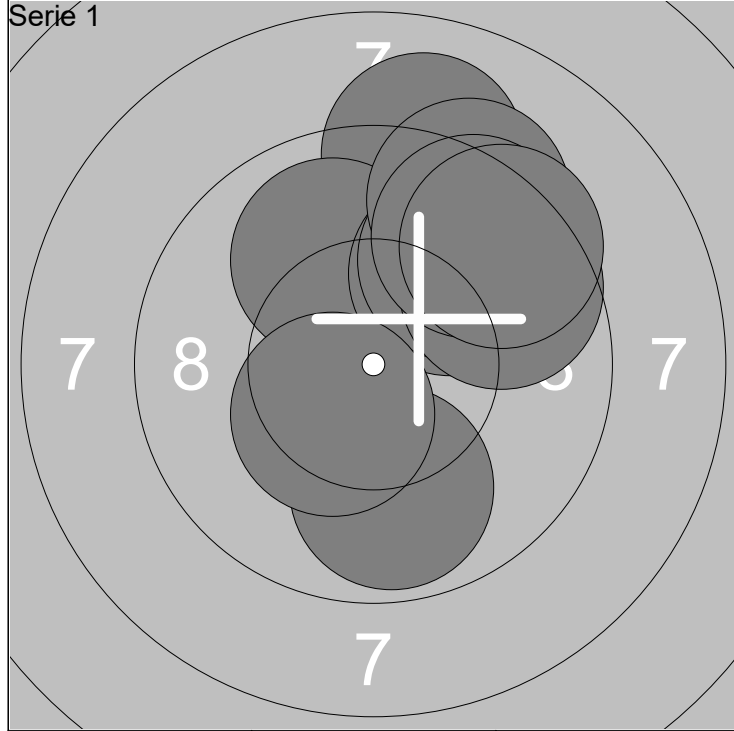

|           |            |       |      |
|-----------|------------|-------|------|
| 1: 9.1 ↗  | 6: 10.4x ↘ | Serie | 96.8 |
| 2: 10.0 ↖ | 7: 9.3 ↗   |       |      |
| 3: 9.8 ↓  | 8: 9.6 ↗   | Total | 96.8 |
| 4: 9.9 ↗  | 9: 9.5 ↗   |       |      |
| 5: 9.8 ↗  | 10: 9.4 ↗  |       |      |

|             |             |       |       |
|-------------|-------------|-------|-------|
| 11: 10.1 →  | 16: 10.9x ↗ | Serie | 97.5  |
| 12: 9.8 ↗   | 17: 10.4x ↖ |       |       |
| 13: 10.5x ↖ | 18: 7.7 ↘   | Total | 194.3 |
| 14: 8.8 ←   | 19: 9.6 ↗   |       |       |
| 15: 10.2x ↘ | 20: 9.5 ↗   |       |       |

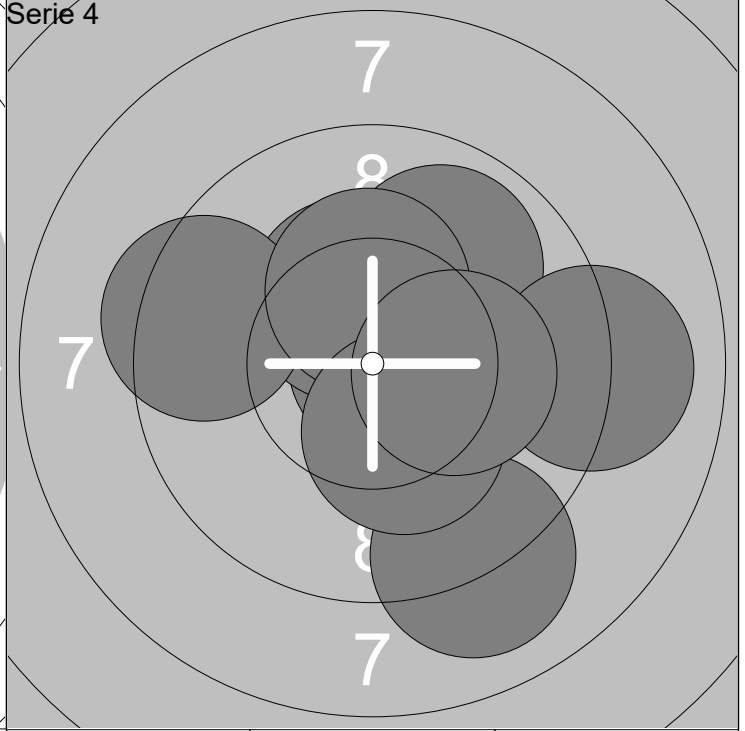
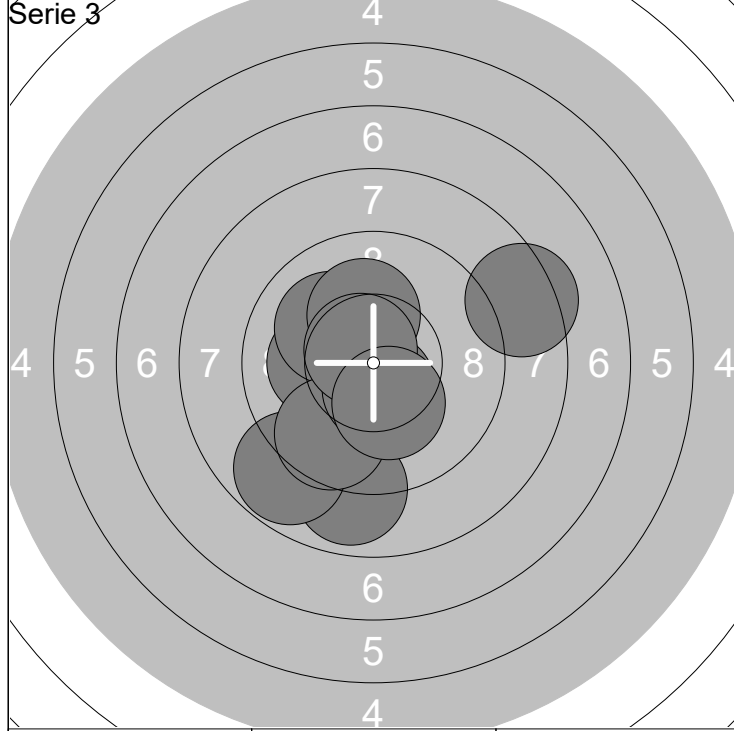

|             |             |       |       |
|-------------|-------------|-------|-------|
| 21: 10.2x ← | 26: 8.4 ↗   | Serie | 97.7  |
| 22: 8.9 ↓   | 27: 9.6 ↘   |       |       |
| 23: 10.1 ↖  | 28: 10.5x ↓ | Total | 292.0 |
| 24: 10.2x ↗ | 29: 10.7x ↖ |       |       |
| 25: 8.8 ↘   | 30: 10.3x ↓ |       |       |

|             |             |       |       |
|-------------|-------------|-------|-------|
| 31: 10.6x ↗ | 36: 9.4 ←   | Serie | 100.0 |
| 32: 9.9 ↗   | 37: 10.3x ↗ |       |       |
| 33: 10.8x → | 38: 9.0 →   | Total | 392.0 |
| 34: 10.4x ↗ | 39: 10.3x ↘ |       |       |
| 35: 9.1 ↘   | 40: 10.2x → |       |       |

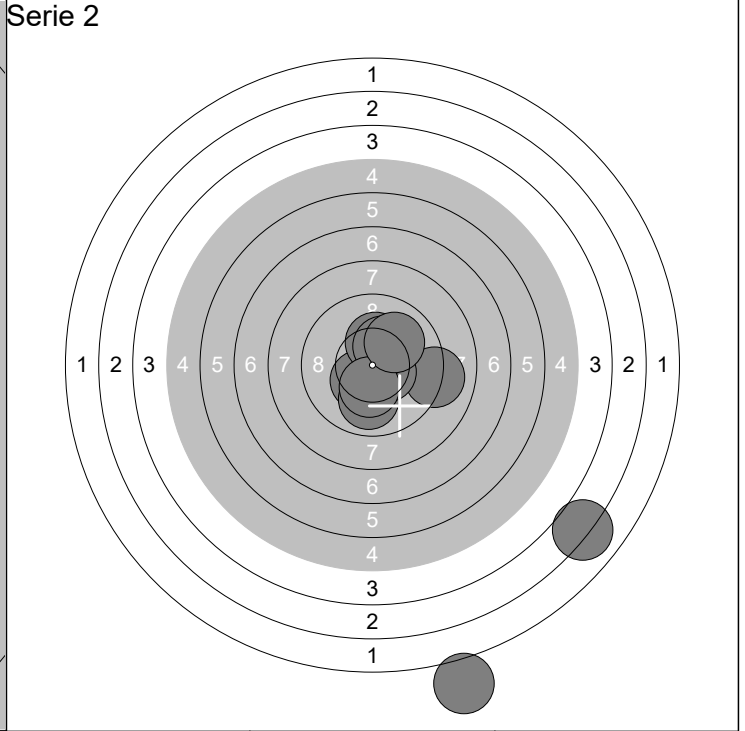
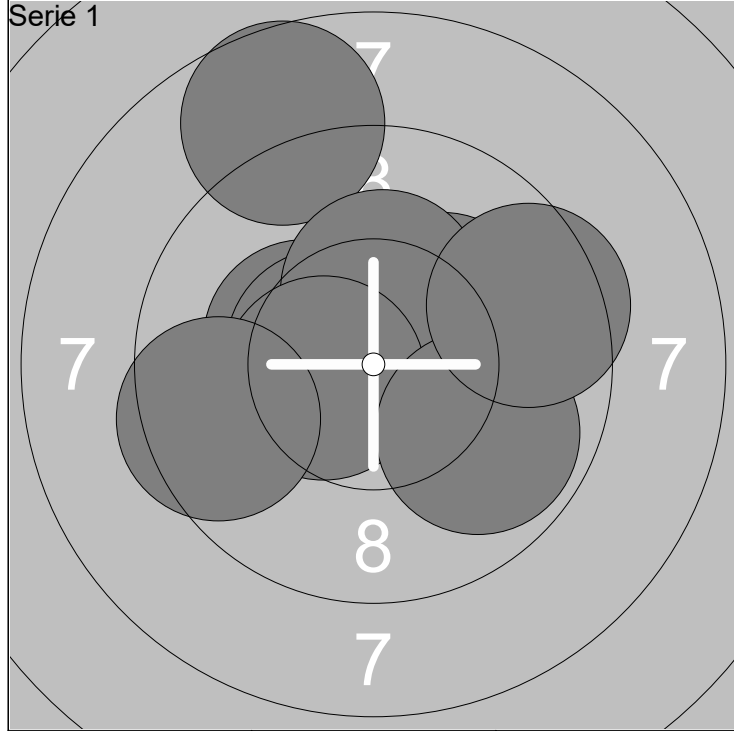

|            |            |                   |
|------------|------------|-------------------|
| 1: 8.7 ↗   | 6: 10.3x ↑ | <b>Serie</b> 99.6 |
| 2: 10.3x ↖ | 7: 10.5x ← |                   |
| 3: 10.2x ↗ | 8: 9.9 ↘   | <b>Total</b> 99.6 |
| 4: 10.5x ↖ | 9: 9.5 ↗   |                   |
| 5: 10.2x → | 10: 9.5 ←  |                   |

|             |             |                    |
|-------------|-------------|--------------------|
| 11: 10.4x ↙ | 16: 10.2x ↑ | <b>Serie</b> 84.9  |
| 12: 9.9 ↓   | 17: 10.3x ↗ |                    |
| 13: 9.1 →   | 18: 10.3x ↓ | <b>Total</b> 184.5 |
| 14: 1.1 ↓   | 19: 10.0 ↗  |                    |
| 15: 10.5x ↘ | 20: 3.1 ↘   |                    |

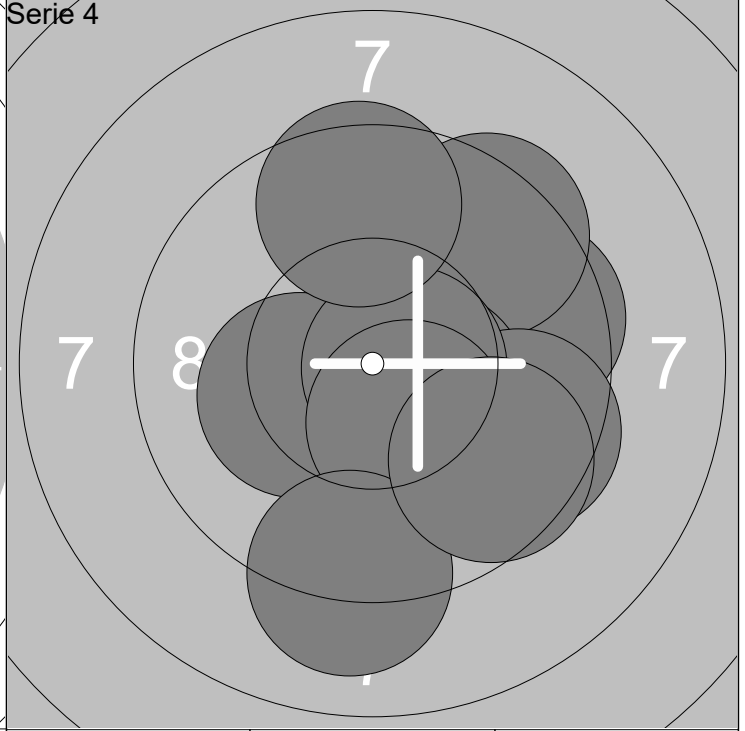
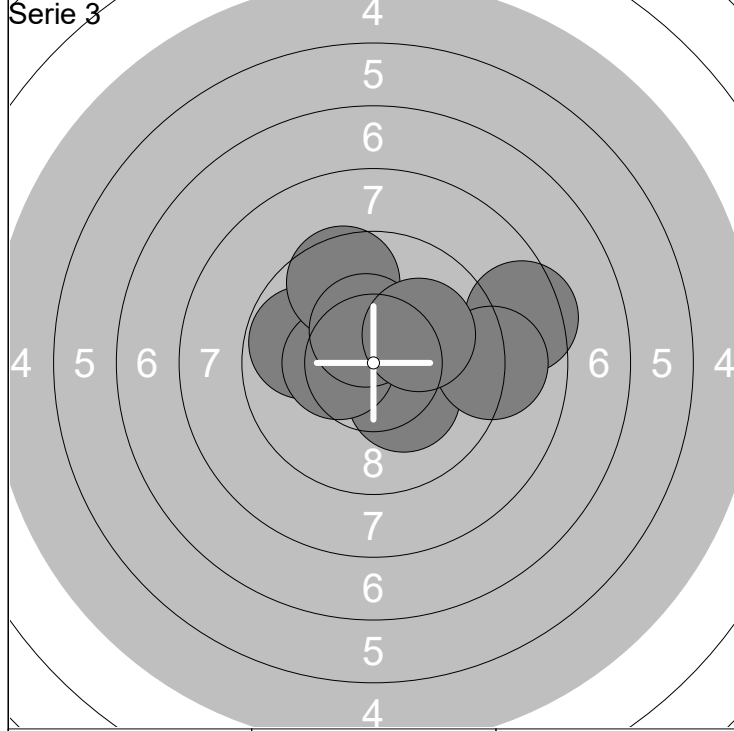

|             |             |                    |
|-------------|-------------|--------------------|
| 21: 10.5x ↑ | 26: 10.4x ← | <b>Serie</b> 98.9  |
| 22: 10.2x ↖ | 27: 9.1 →   |                    |
| 23: 10.3x ↘ | 28: 9.6 ↑   | <b>Total</b> 283.4 |
| 24: 9.8 ↖   | 29: 10.4x ↑ |                    |
| 25: 8.5 →   | 30: 10.1 ↗  |                    |

|             |             |                    |
|-------------|-------------|--------------------|
| 31: 10.2x ↖ | 36: 10.7x → | <b>Serie</b> 98.4  |
| 32: 9.6 →   | 37: 10.3x ↓ |                    |
| 33: 9.5 ↗   | 38: 9.1 ↓   | <b>Total</b> 381.8 |
| 34: 10.4x ↘ | 39: 9.6 ↘   |                    |
| 35: 9.5 ↘   | 40: 9.5 ↑   |                    |

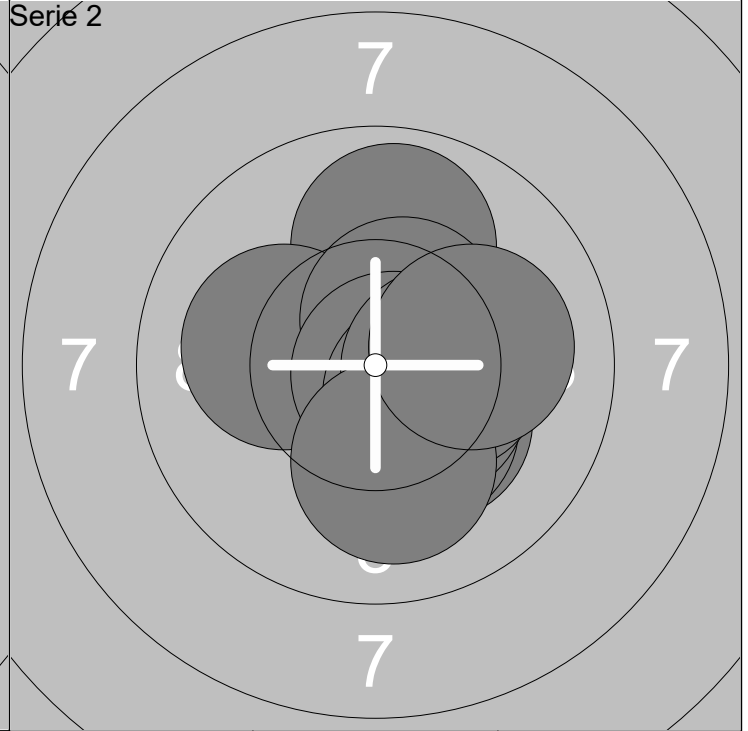
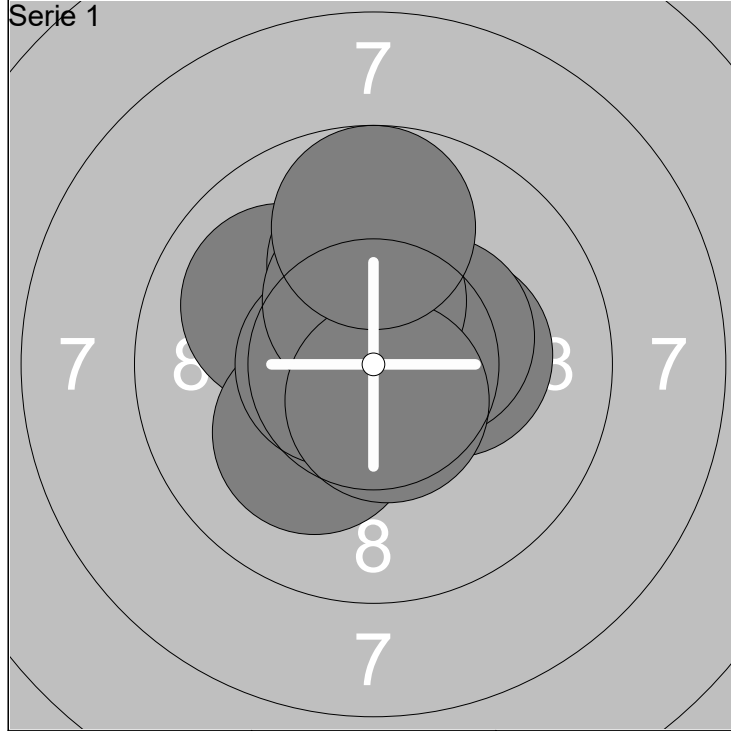

|            |            |       |       |
|------------|------------|-------|-------|
| 1: 10.3x → | 6: 10.4x ↑ | Serie | 102.7 |
| 2: 10.0 ↖  | 7: 10.4x → |       |       |
| 3: 10.2x ↙ | 8: 10.4x ↑ | Total | 102.7 |
| 4: 10.6x ← | 9: 10.6x ↓ |       |       |
| 5: 10.1 ↑  | 10: 9.7 ↑  |       |       |

|             |             |       |       |
|-------------|-------------|-------|-------|
| 11: 9.9 ↑   | 16: 10.8x ↘ | Serie | 102.9 |
| 12: 10.3x ↘ | 17: 10.4x ↘ |       |       |
| 13: 10.1 ←  | 18: 10.4x → | Total | 205.6 |
| 14: 10.5x ↗ | 19: 10.1 ↓  |       |       |
| 15: 10.3x ↘ | 20: 10.1 →  |       |       |

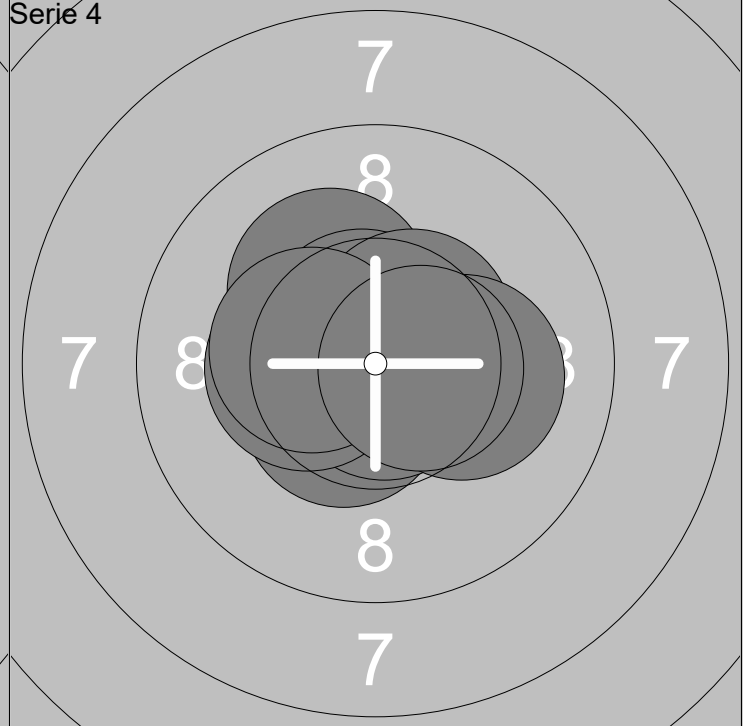
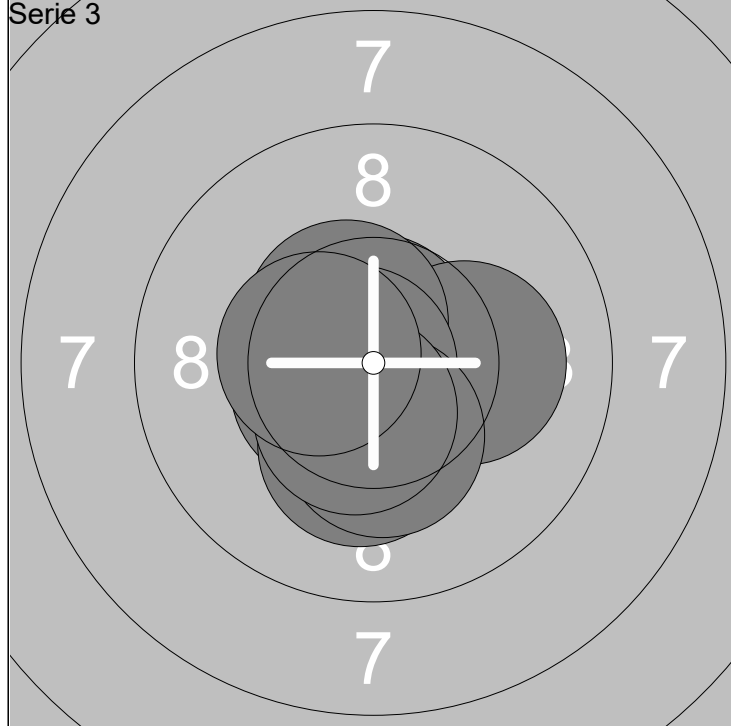

|             |             |       |       |
|-------------|-------------|-------|-------|
| 21: 10.5x ↖ | 26: 10.8x ← | Serie | 104.7 |
| 22: 10.7x ↑ | 27: 10.2x ↓ |       |       |
| 23: 10.6x ↖ | 28: 10.3x ↓ | Total | 310.3 |
| 24: 10.1 →  | 29: 10.5x ↓ |       |       |
| 25: 10.5x ↗ | 30: 10.5x ← |       |       |

|             |             |       |       |
|-------------|-------------|-------|-------|
| 31: 10.2x ↖ | 36: 10.8x ↘ | Serie | 105.1 |
| 32: 10.7x ↗ | 37: 10.2x → |       |       |
| 33: 10.8x ← | 38: 10.3x ← | Total | 415.4 |
| 34: 10.5x ↙ | 39: 10.4x ← |       |       |
| 35: 10.6x ↗ | 40: 10.6x → |       |       |

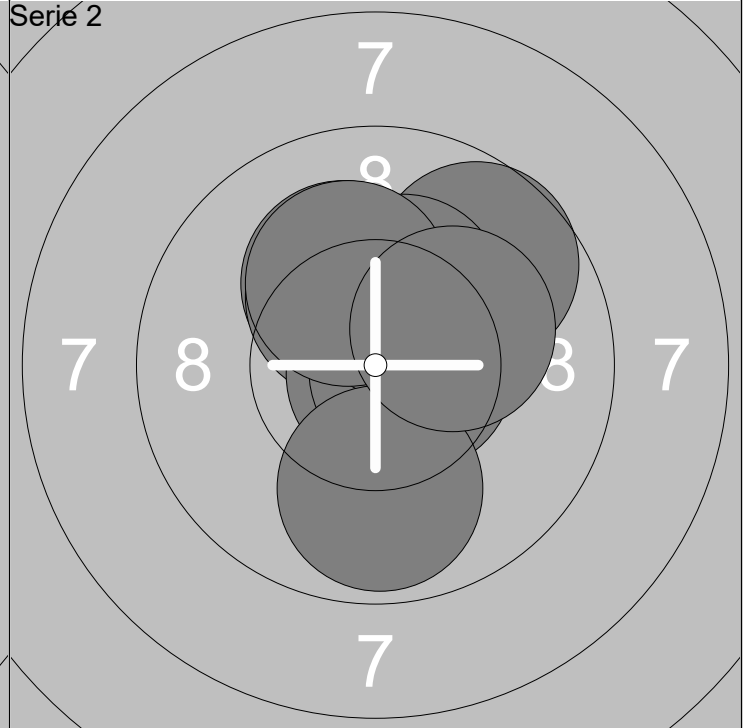
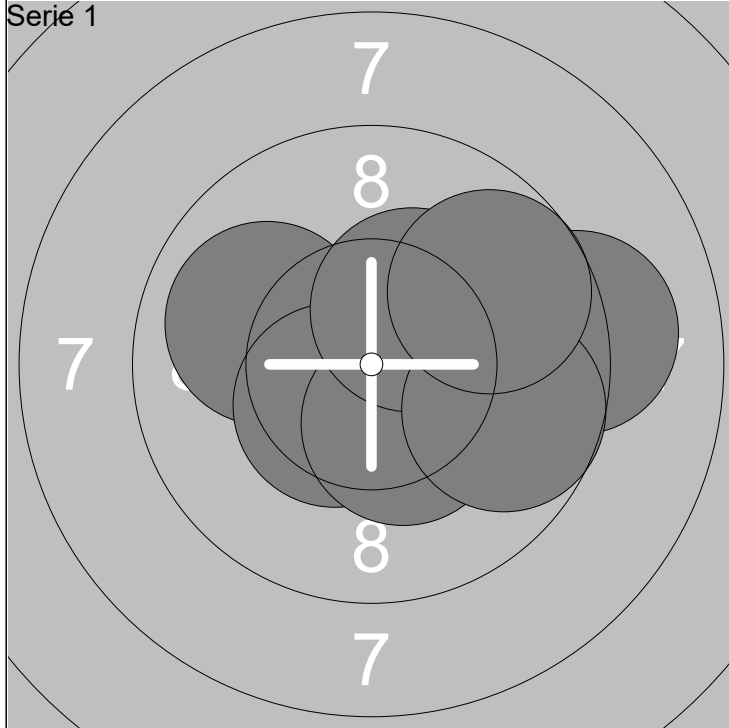

|            |            |       |       |
|------------|------------|-------|-------|
| 1: 10.6x ↙ | 6: 10.4x ↘ | Serie | 101.2 |
| 2: 10.8x ↓ | 7: 10.3x ↗ |       |       |
| 3: 10.0 ↖  | 8: 9.1 →   | Total | 101.2 |
| 4: 10.4x ↙ | 9: 9.7 ↘   |       |       |
| 5: 10.2x → | 10: 9.7 ↗  |       |       |

|             |             |       |       |
|-------------|-------------|-------|-------|
| 11: 10.2x ↗ | 16: 9.7 ↗   | Serie | 103.0 |
| 12: 10.3x ↗ | 17: 10.3x ↗ |       |       |
| 13: 10.8x ↗ | 18: 9.9 ↓   | Total | 204.2 |
| 14: 10.8x ↘ | 19: 10.2x ↗ |       |       |
| 15: 10.6x → | 20: 10.2x ↗ |       |       |

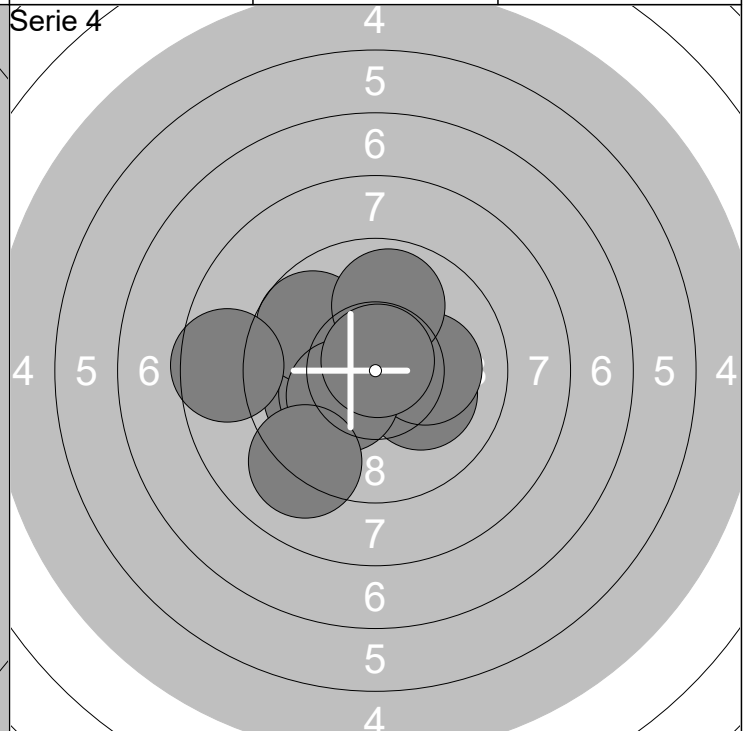
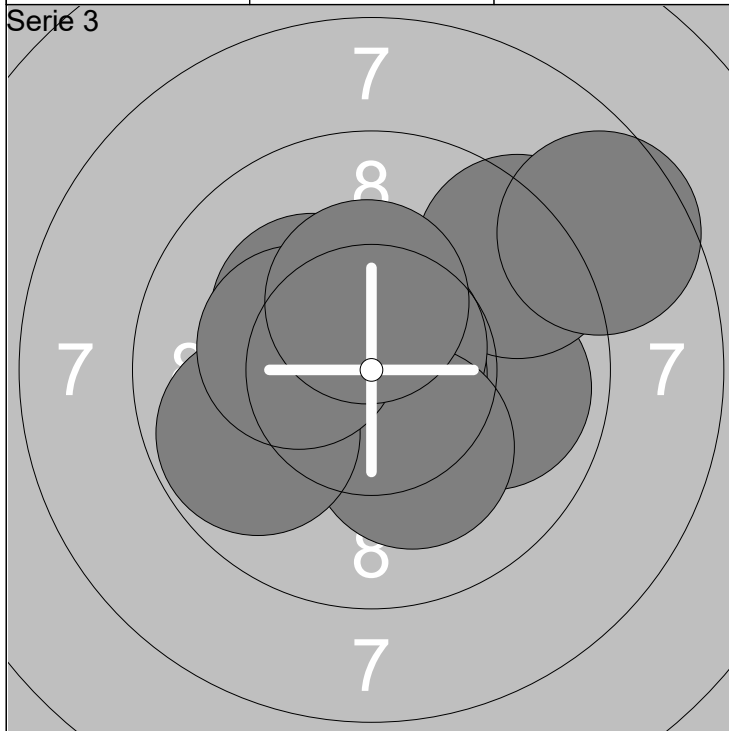

|             |             |       |       |
|-------------|-------------|-------|-------|
| 21: 10.2x ↖ | 26: 10.2x ↘ | Serie | 100.2 |
| 22: 9.9 →   | 27: 8.6 ↗   |       |       |
| 23: 9.3 ↗   | 28: 9.8 ↖   | Total | 304.4 |
| 24: 10.8x → | 29: 10.3x ↖ |       |       |
| 25: 10.7x ↗ | 30: 10.4x ↗ |       |       |

|             |             |       |       |
|-------------|-------------|-------|-------|
| 31: 10.2x → | 36: 10.3x ↖ | Serie | 98.9  |
| 32: 10.0 ↖  | 37: 9.9 ↗   |       |       |
| 33: 10.2x ↖ | 38: 8.6 ↖   | Total | 403.3 |
| 34: 10.1 →  | 39: 9.1 ↘   |       |       |
| 35: 9.7 ↖   | 40: 10.8x ↗ |       |       |



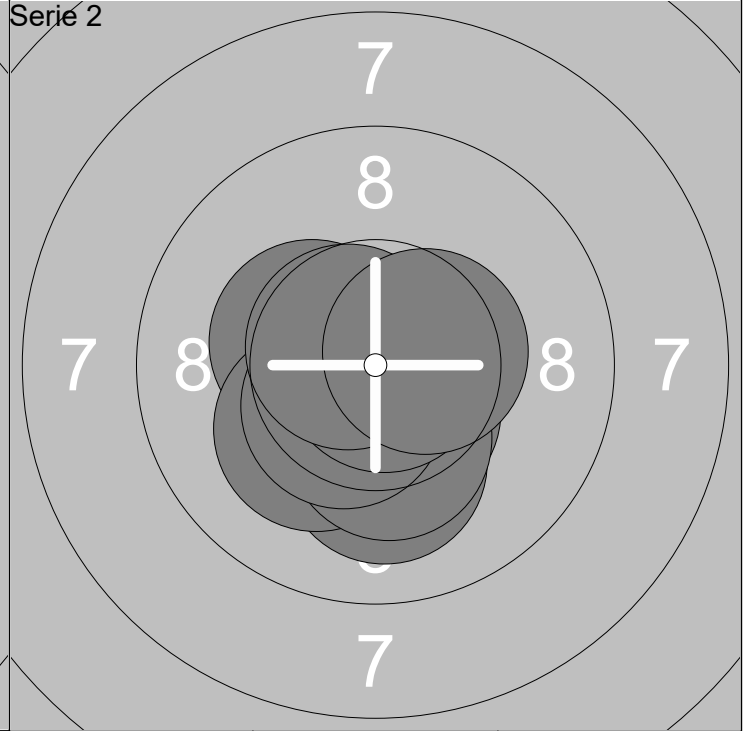
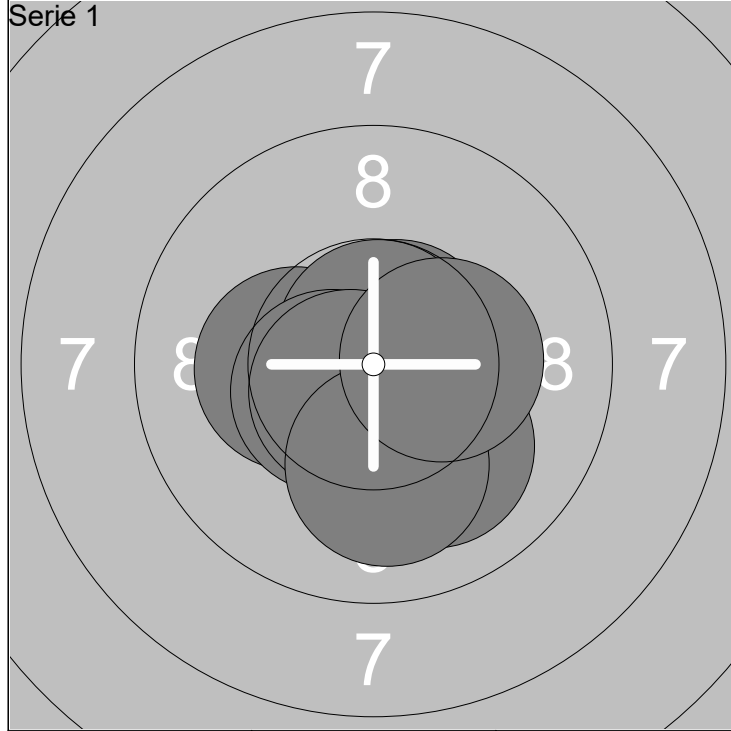

|            |             |                |
|------------|-------------|----------------|
| 1: 10.6x ↙ | 6: 10.0 ↘   | Serie<br>104.3 |
| 2: 10.7x ↗ | 7: 10.5x ↓  |                |
| 3: 10.3x ← | 8: 10.6x ↙  | Total<br>104.3 |
| 4: 10.7x ↑ | 9: 10.1 ↓   |                |
| 5: 10.5x ↙ | 10: 10.3x → |                |

|             |             |                |
|-------------|-------------|----------------|
| 11: 10.4x ↖ | 16: 10.3x ↓ | Serie<br>104.6 |
| 12: 10.1 ↓  | 17: 10.5x ↙ |                |
| 13: 10.5x ↘ | 18: 10.9x ↗ | Total<br>208.9 |
| 14: 10.5x ↓ | 19: 10.7x ↖ |                |
| 15: 10.2x ↙ | 20: 10.5x → |                |

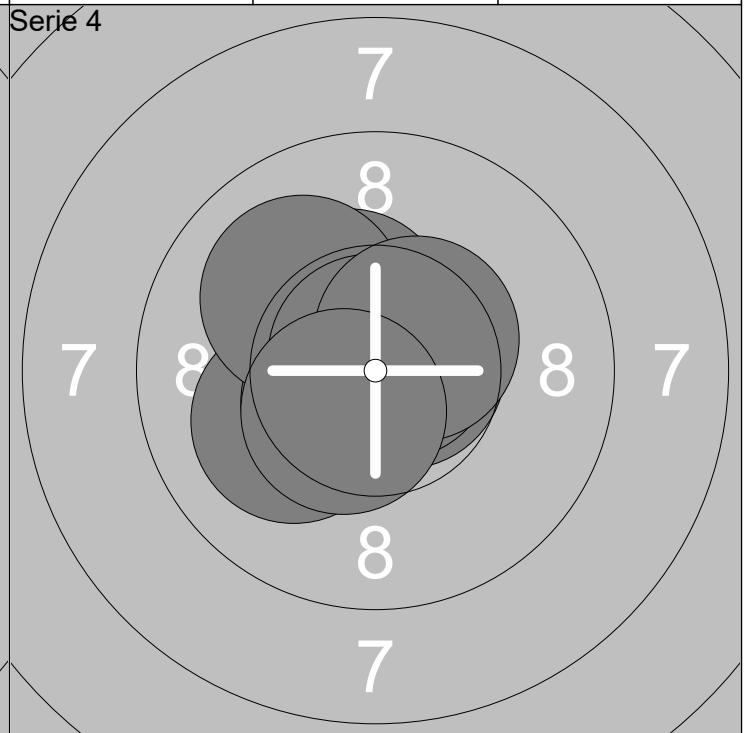
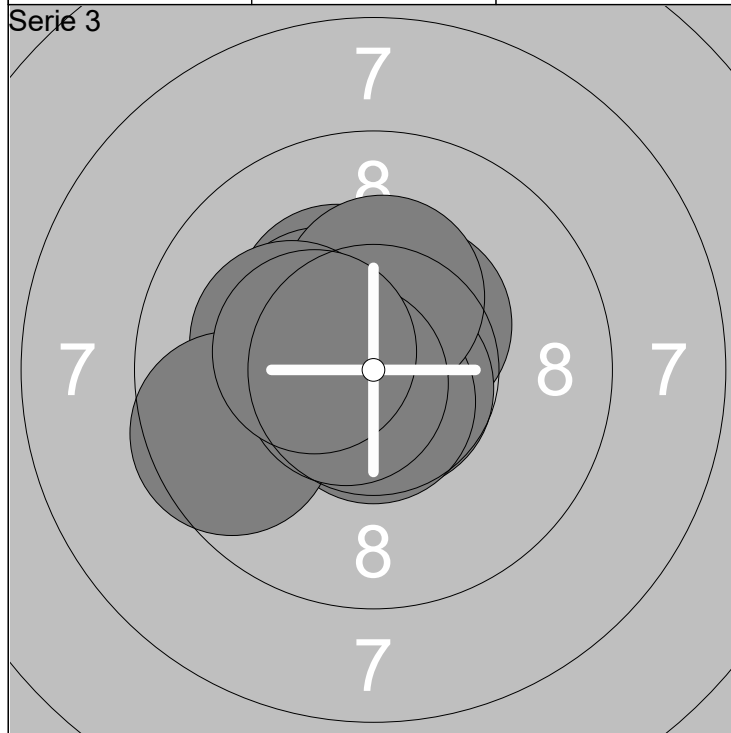

|             |             |                |
|-------------|-------------|----------------|
| 21: 10.4x ↗ | 26: 10.3x ↑ | Serie<br>103.7 |
| 22: 10.7x ↘ | 27: 10.2x ↖ |                |
| 23: 10.7x ↓ | 28: 9.6 ←   | Total<br>312.6 |
| 24: 10.3x ↗ | 29: 10.7x ↖ |                |
| 25: 10.4x ↖ | 30: 10.4x ↖ |                |

|             |             |                |
|-------------|-------------|----------------|
| 31: 10.1 ↖  | 36: 10.7x ↗ | Serie<br>104.6 |
| 32: 10.3x ↖ | 37: 10.0 ↖  |                |
| 33: 10.6x ↙ | 38: 10.8x ↑ | Total<br>417.2 |
| 34: 10.4x ↗ | 39: 10.5x ↗ |                |
| 35: 10.7x → | 40: 10.5x ↙ |                |

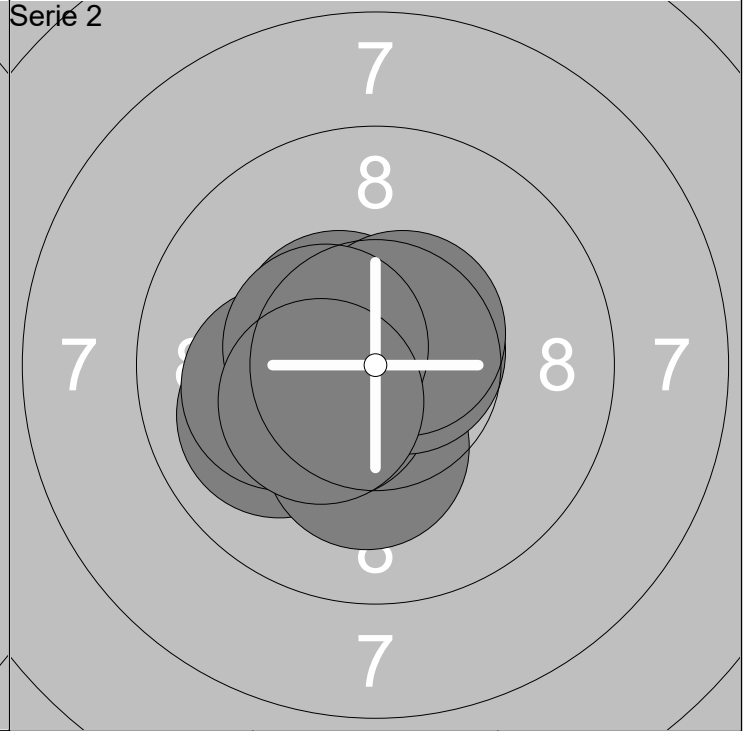
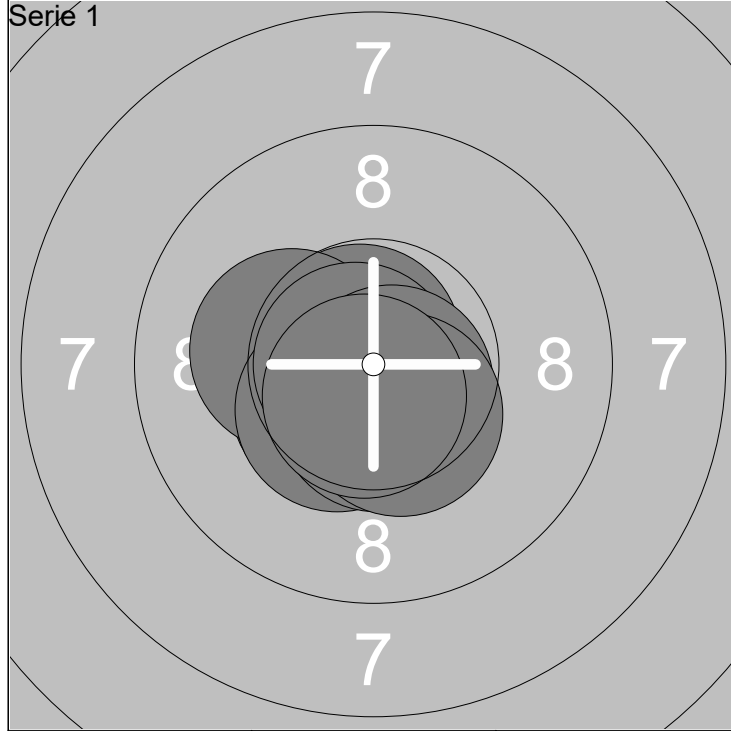

|            |             |                |
|------------|-------------|----------------|
| 1: 10.5x ↙ | 6: 10.8x ←  | Serie<br>105.8 |
| 2: 10.8x ↗ | 7: 10.5x ↓  |                |
| 3: 10.7x ← | 8: 10.7x ↘  | Total<br>105.8 |
| 4: 10.2x ← | 9: 10.5x ↓  |                |
| 5: 10.4x ↙ | 10: 10.7x ↓ |                |

|             |             |                |
|-------------|-------------|----------------|
| 11: 10.2x ↙ | 16: 10.7x ↗ | Serie<br>103.7 |
| 12: 10.5x ↖ | 17: 10.6x ↗ |                |
| 13: 10.0 ←  | 18: 10.1 ←  | Total<br>209.5 |
| 14: 10.2x ↓ | 19: 10.5x ← |                |
| 15: 10.5x ↙ | 20: 10.4x ↙ |                |

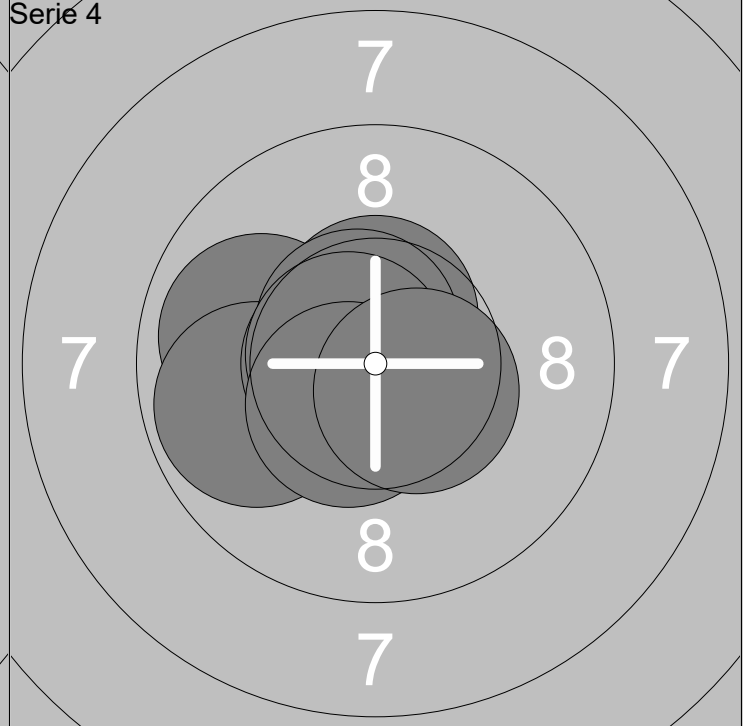
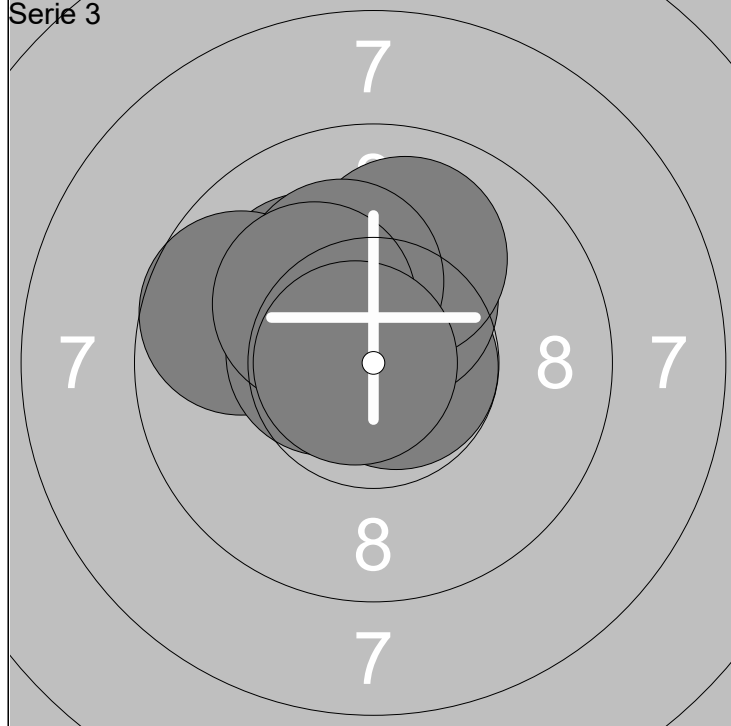

|             |             |                |
|-------------|-------------|----------------|
| 21: 10.1 ↗  | 26: 10.4x ↗ | Serie<br>103.4 |
| 22: 10.7x ↗ | 27: 10.0 ↗  |                |
| 23: 9.7 ←   | 28: 10.2x ↗ | Total<br>312.9 |
| 24: 10.6x ← | 29: 10.2x ↖ |                |
| 25: 10.7x → | 30: 10.8x ← |                |

|             |             |                |
|-------------|-------------|----------------|
| 31: 10.6x ↑ | 36: 10.6x ↖ | Serie<br>104.8 |
| 32: 9.9 ←   | 37: 10.7x ← |                |
| 33: 9.8 ←   | 38: 10.7x ← | Total<br>417.7 |
| 34: 10.7x ← | 39: 10.5x ↘ |                |
| 35: 10.8x ↘ | 40: 10.5x ↘ |                |

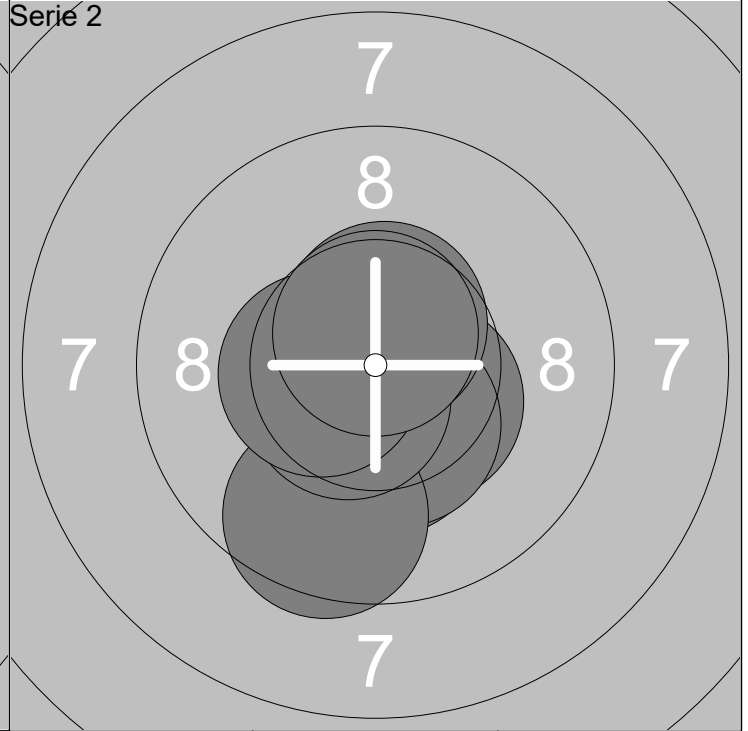
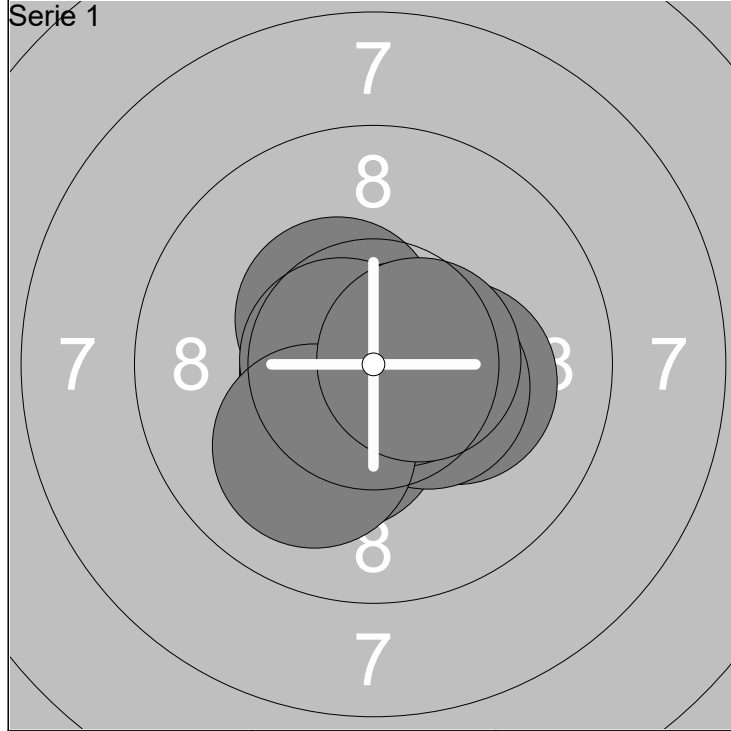

|            |             |       |       |
|------------|-------------|-------|-------|
| 1: 10.8x → | 6: 10.7x →  | Serie | 105.0 |
| 2: 10.2x → | 7: 10.7x ←  |       |       |
| 3: 10.3x ↓ | 8: 10.7x ←  | Total | 105.0 |
| 4: 10.5x ↗ | 9: 10.1 ↓   |       |       |
| 5: 10.4x → | 10: 10.6x → |       |       |

|             |             |       |       |
|-------------|-------------|-------|-------|
| 11: 10.6x ↑ | 16: 10.6x ↑ | Serie | 104.1 |
| 12: 10.3x ↓ | 17: 9.5 ↓   |       |       |
| 13: 10.4x ↘ | 18: 10.6x ↓ | Total | 209.1 |
| 14: 10.5x ↓ | 19: 10.5x ← |       |       |
| 15: 10.4x ↓ | 20: 10.7x ↑ |       |       |

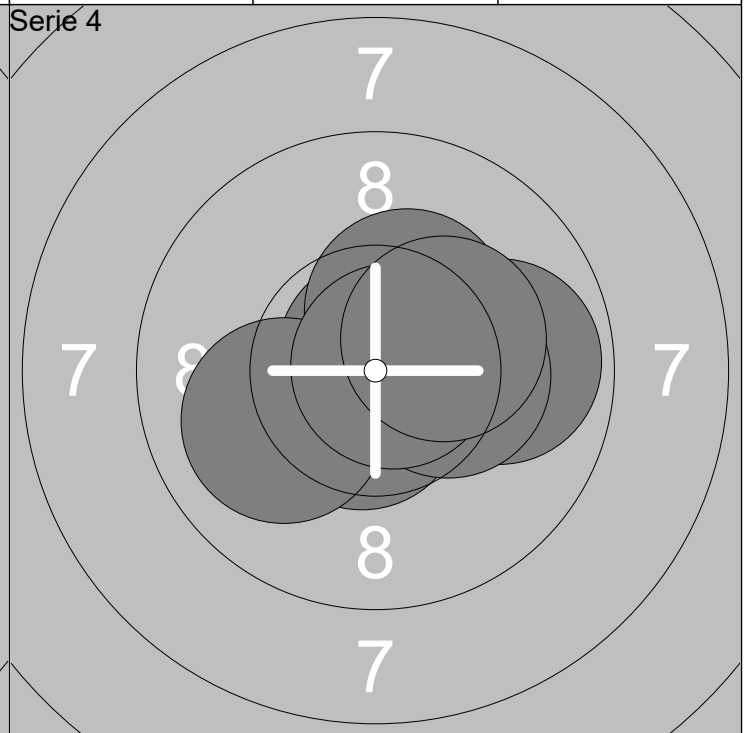
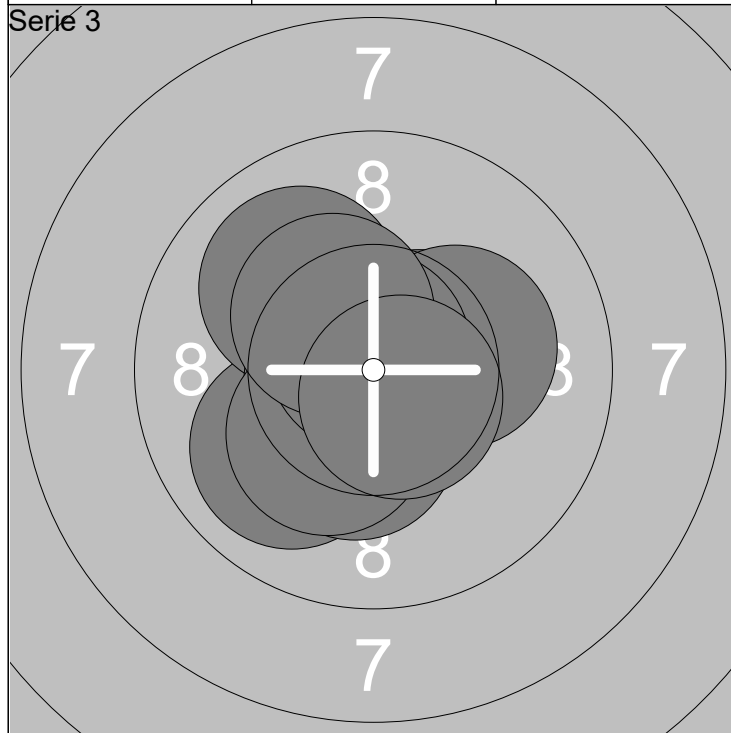

|             |             |       |       |
|-------------|-------------|-------|-------|
| 21: 10.0 ↙  | 26: 10.2x → | Serie | 103.7 |
| 22: 10.3x ↓ | 27: 10.3x ↓ |       |       |
| 23: 10.0 ↖  | 28: 10.8x ↑ | Total | 312.8 |
| 24: 10.7x ← | 29: 10.3x ↗ |       |       |
| 25: 10.5x ↗ | 30: 10.6x ↓ |       |       |

|             |             |       |       |
|-------------|-------------|-------|-------|
| 31: 10.3x ↗ | 36: 9.9 →   | Serie | 103.9 |
| 32: 10.5x ↗ | 37: 10.4x ↑ |       |       |
| 33: 10.6x ↓ | 38: 10.3x → | Total | 416.7 |
| 34: 10.8x ↑ | 39: 10.8x → |       |       |
| 35: 10.0 ↙  | 40: 10.3x ↗ |       |       |

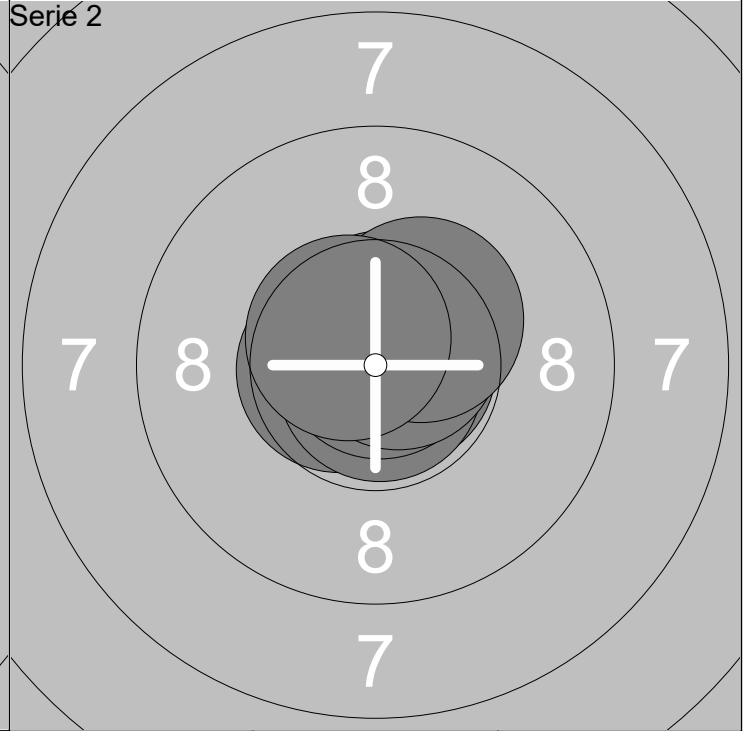
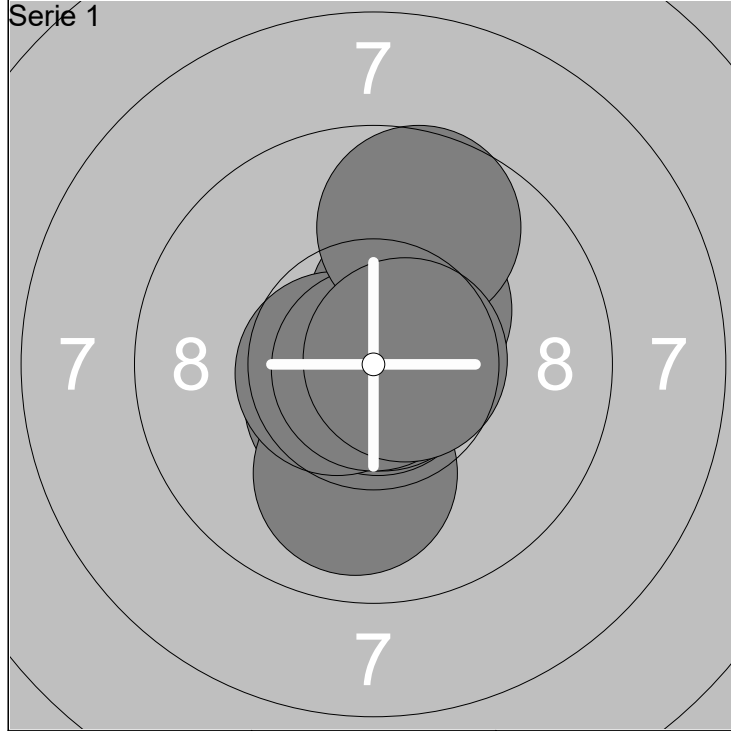

|            |             |       |       |
|------------|-------------|-------|-------|
| 1: 10.5x ↙ | 6: 10.6x ←  | Serie | 105.4 |
| 2: 10.9x ↗ | 7: 10.9x →  |       |       |
| 3: 10.0 ↓  | 8: 10.9x ↓  | Total | 105.4 |
| 4: 10.4x ↗ | 9: 9.7 ↑    |       |       |
| 5: 10.9x ↓ | 10: 10.6x → |       |       |

|             |             |       |       |
|-------------|-------------|-------|-------|
| 11: 10.8x → | 16: 10.8x ↓ | Serie | 106.8 |
| 12: 10.6x ← | 17: 10.9x ↑ |       |       |
| 13: 10.7x ↑ | 18: 10.7x ↗ | Total | 212.2 |
| 14: 10.7x ↗ | 19: 10.4x ↗ |       |       |
| 15: 10.6x ↑ | 20: 10.6x ↖ |       |       |

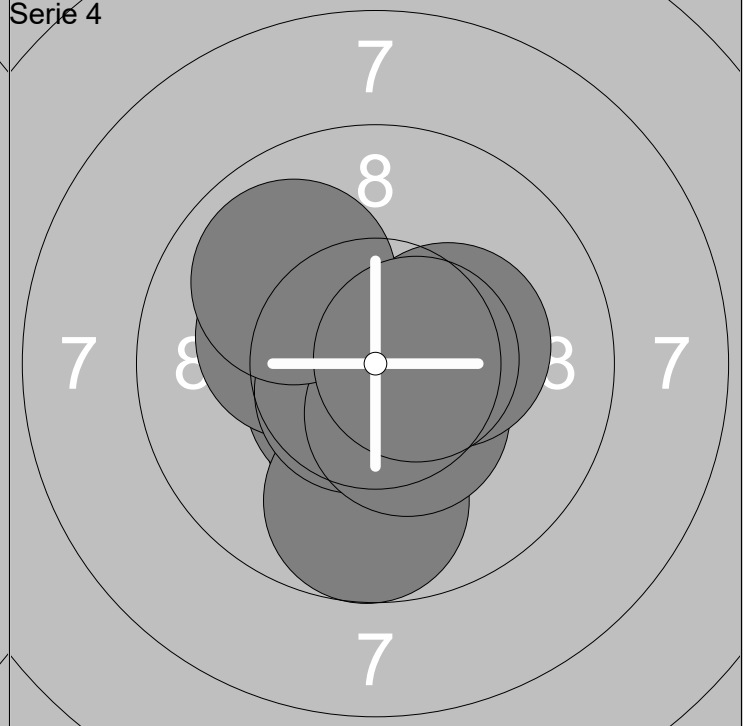
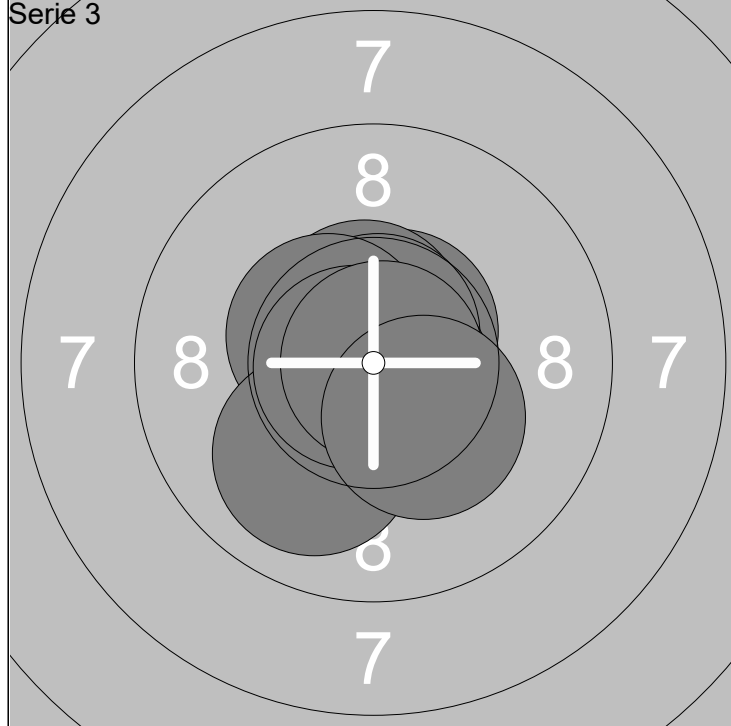

|             |             |       |       |
|-------------|-------------|-------|-------|
| 21: 10.6x ↗ | 26: 10.7x ↓ | Serie | 105.8 |
| 22: 10.6x ↑ | 27: 10.0 ↓  |       |       |
| 23: 10.7x ↗ | 28: 10.8x ← | Total | 318.0 |
| 24: 10.7x ↑ | 29: 10.9x → |       |       |
| 25: 10.5x ↖ | 30: 10.3x ↓ |       |       |

|             |             |       |       |
|-------------|-------------|-------|-------|
| 31: 10.4x ↓ | 36: 10.7x ↓ | Serie | 103.8 |
| 32: 10.6x ↓ | 37: 10.4x ↓ |       |       |
| 33: 10.9x ← | 38: 10.3x → | Total | 421.8 |
| 34: 10.2x ← | 39: 9.9 ↖   |       |       |
| 35: 9.8 ↓   | 40: 10.6x → |       |       |

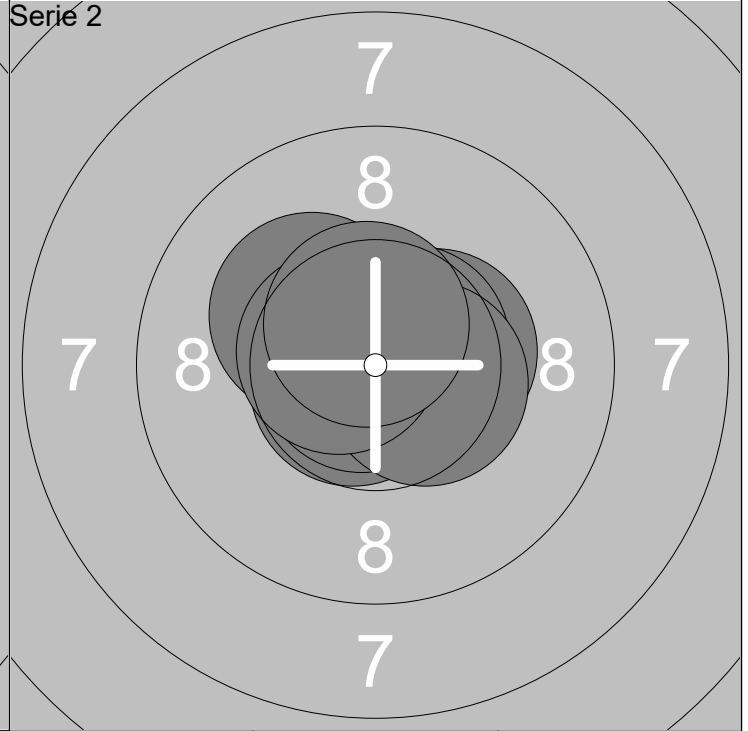
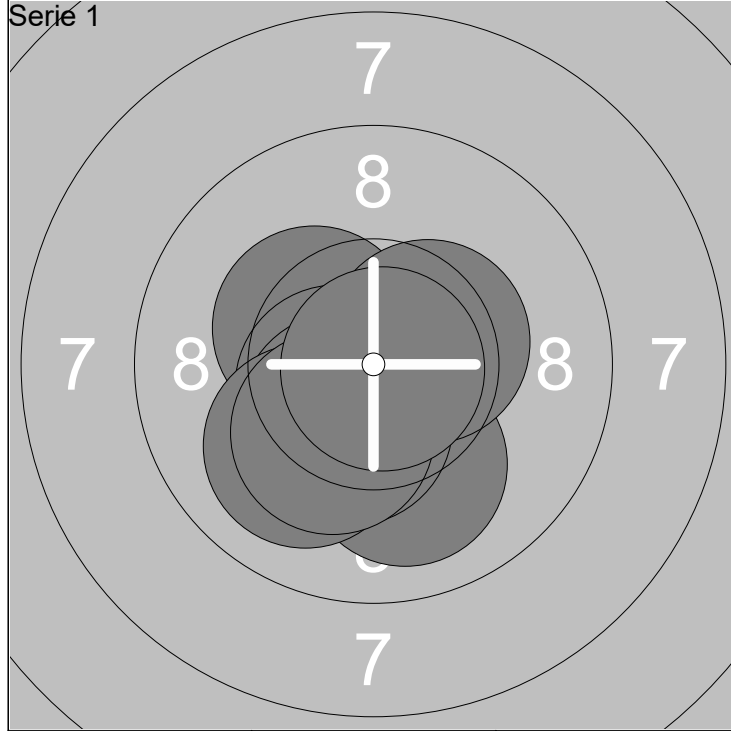

|            |             |       |       |
|------------|-------------|-------|-------|
| 1: 10.8x → | 6: 10.0 ↙   | Serie | 104.1 |
| 2: 10.3x ↖ | 7: 10.4x ↓  |       |       |
| 3: 10.6x ↙ | 8: 10.3x ↓  | Total | 104.1 |
| 4: 10.0 ↓  | 9: 10.4x →  |       |       |
| 5: 10.4x ↙ | 10: 10.9x ↘ |       |       |

|             |             |       |       |
|-------------|-------------|-------|-------|
| 11: 10.2x ↖ | 16: 10.7x ↙ | Serie | 106.0 |
| 12: 10.4x → | 17: 10.8x ↖ |       |       |
| 13: 10.8x ↑ | 18: 10.5x → | Total | 210.1 |
| 14: 10.8x ← | 19: 10.6x ↖ |       |       |
| 15: 10.6x ↗ | 20: 10.6x ↑ |       |       |

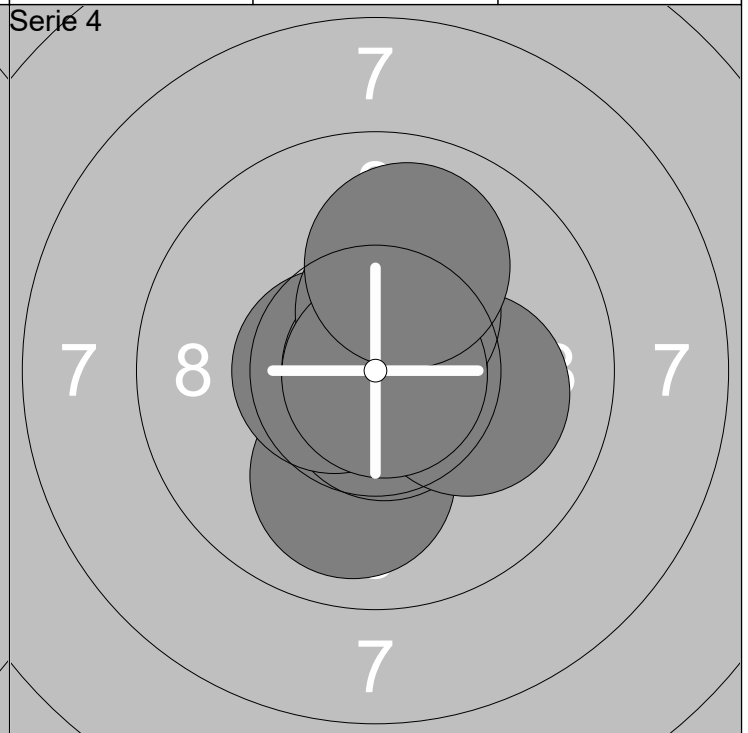
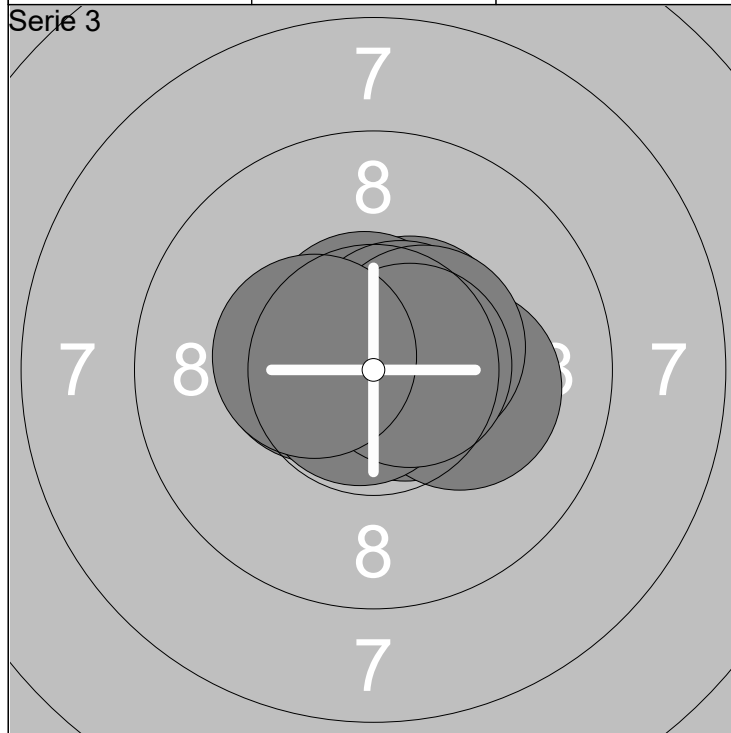

|             |             |       |       |
|-------------|-------------|-------|-------|
| 21: 10.5x ← | 26: 10.6x ↗ | Serie | 105.4 |
| 22: 10.5x ↗ | 27: 10.5x → |       |       |
| 23: 10.6x ↑ | 28: 10.8x ↙ | Total | 315.5 |
| 24: 10.7x → | 29: 10.6x → |       |       |
| 25: 10.2x → | 30: 10.4x ← |       |       |

|             |             |       |       |
|-------------|-------------|-------|-------|
| 31: 10.8x ↗ | 36: 10.6x ← | Serie | 105.2 |
| 32: 10.8x ↘ | 37: 10.9x → |       |       |
| 33: 10.0 ↓  | 38: 10.4x ↑ | Total | 420.7 |
| 34: 10.7x ↓ | 39: 10.9x ↘ |       |       |
| 35: 10.1 →  | 40: 10.0 ↑  |       |       |

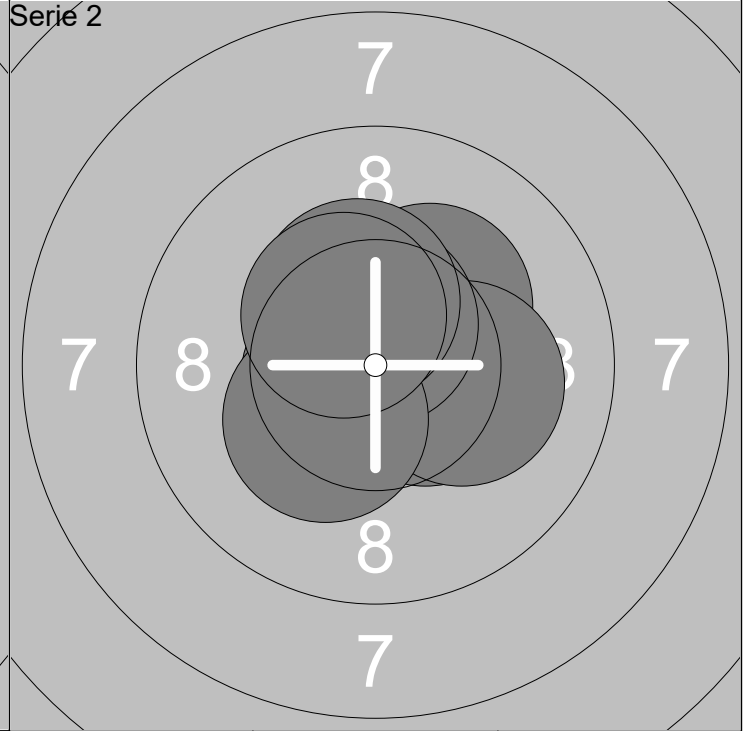
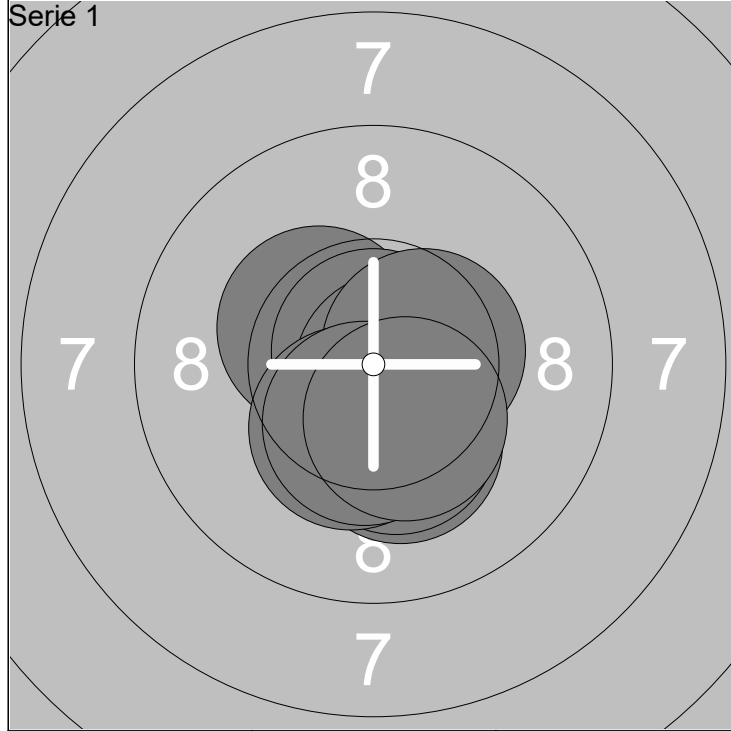

|            |             |       |       |
|------------|-------------|-------|-------|
| 1: 10.4x ↙ | 6: 10.5x →  | Serie | 104.3 |
| 2: 10.3x ↓ | 7: 10.3x ↓  |       |       |
| 3: 10.2x ↓ | 8: 10.3x ↓  | Total | 104.3 |
| 4: 10.8x ↑ | 9: 10.4x ↓  |       |       |
| 5: 10.7x → | 10: 10.4x ↓ |       |       |

|             |             |       |       |
|-------------|-------------|-------|-------|
| 11: 10.2x ↗ | 16: 10.7x ↗ | Serie | 104.5 |
| 12: 10.5x → | 17: 10.6x ↑ |       |       |
| 13: 10.6x ↑ | 18: 10.3x ↙ | Total | 208.8 |
| 14: 10.6x ← | 19: 10.4x ↑ |       |       |
| 15: 10.2x → | 20: 10.4x ↘ |       |       |

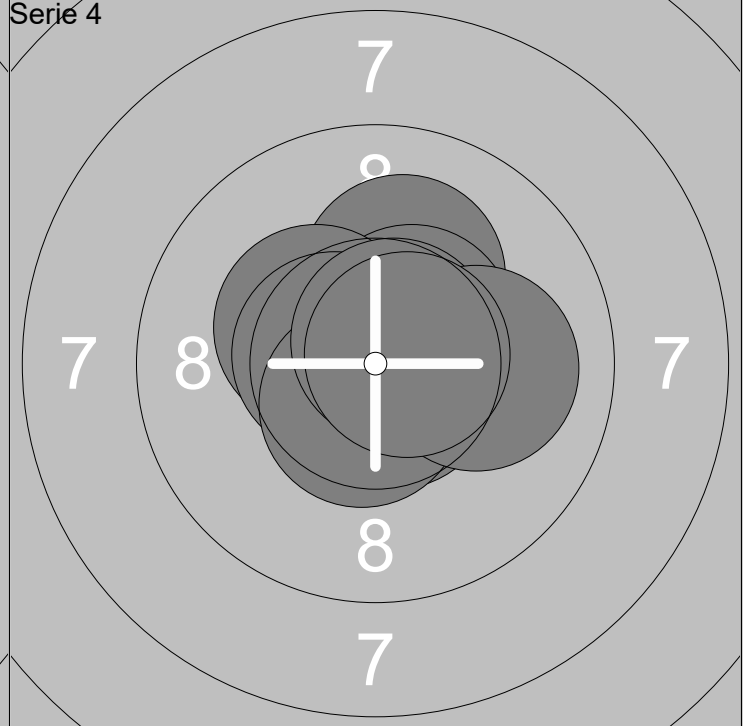
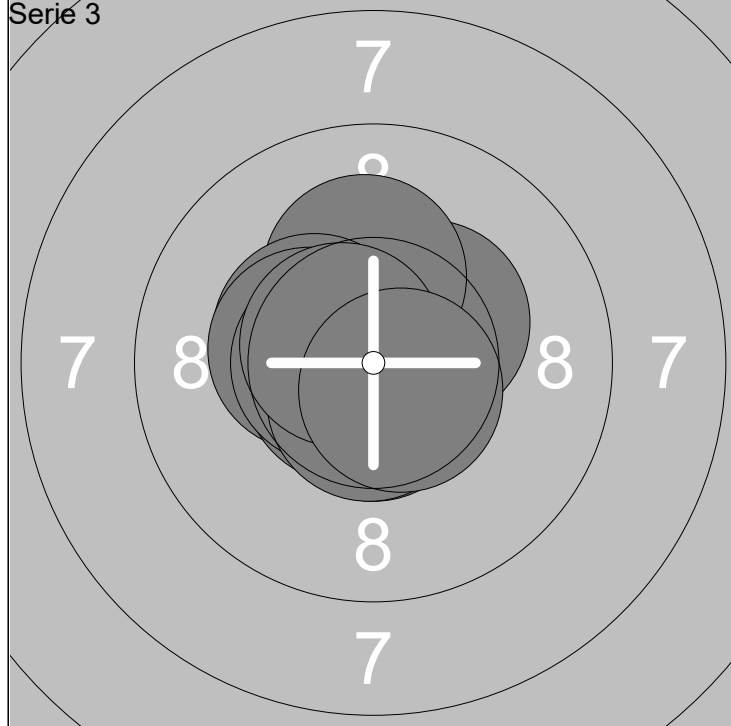

|             |             |       |       |
|-------------|-------------|-------|-------|
| 21: 10.4x ↗ | 26: 10.6x ↓ | Serie | 105.1 |
| 22: 10.2x ↑ | 27: 10.6x ← |       |       |
| 23: 10.4x ↙ | 28: 10.6x ↓ | Total | 313.9 |
| 24: 10.4x ← | 29: 10.6x ↙ |       |       |
| 25: 10.7x ↘ | 30: 10.6x ↓ |       |       |

|             |             |       |       |
|-------------|-------------|-------|-------|
| 31: 10.7x ↓ | 36: 10.6x ← | Serie | 105.1 |
| 32: 10.2x ↑ | 37: 10.6x ↓ |       |       |
| 33: 10.5x ↗ | 38: 10.7x ↗ | Total | 419.0 |
| 34: 10.4x ↙ | 39: 10.1 →  |       |       |
| 35: 10.7x ↓ | 40: 10.6x → |       |       |

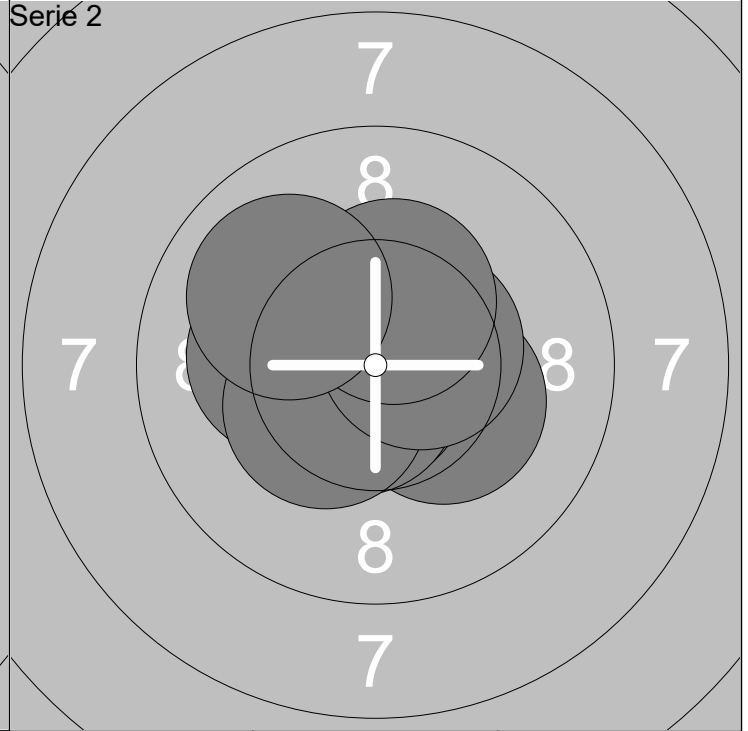
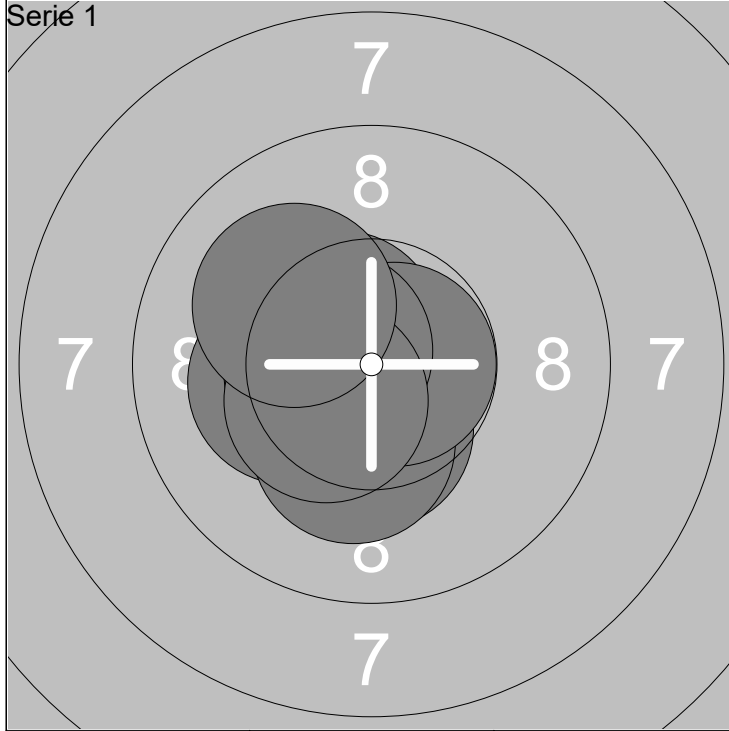

|            |            |       |       |
|------------|------------|-------|-------|
| 1: 10.2x ← | 6: 10.6x ← | Serie | 104.8 |
| 2: 10.4x ↓ | 7: 10.8x → |       |       |
| 3: 10.2x ↓ | 8: 10.6x ← | Total | 104.8 |
| 4: 10.6x ↖ | 9: 10.5x ↙ |       |       |
| 5: 10.8x ← | 10: 10.1 ↖ |       |       |

|             |             |       |       |
|-------------|-------------|-------|-------|
| 11: 10.3x → | 16: 10.2x ← | Serie | 104.5 |
| 12: 10.8x ↙ | 17: 10.4x ↙ |       |       |
| 13: 10.7x ↙ | 18: 10.5x → | Total | 209.3 |
| 14: 10.6x ↖ | 19: 10.4x ↑ |       |       |
| 15: 10.6x ↑ | 20: 10.0 ↖  |       |       |

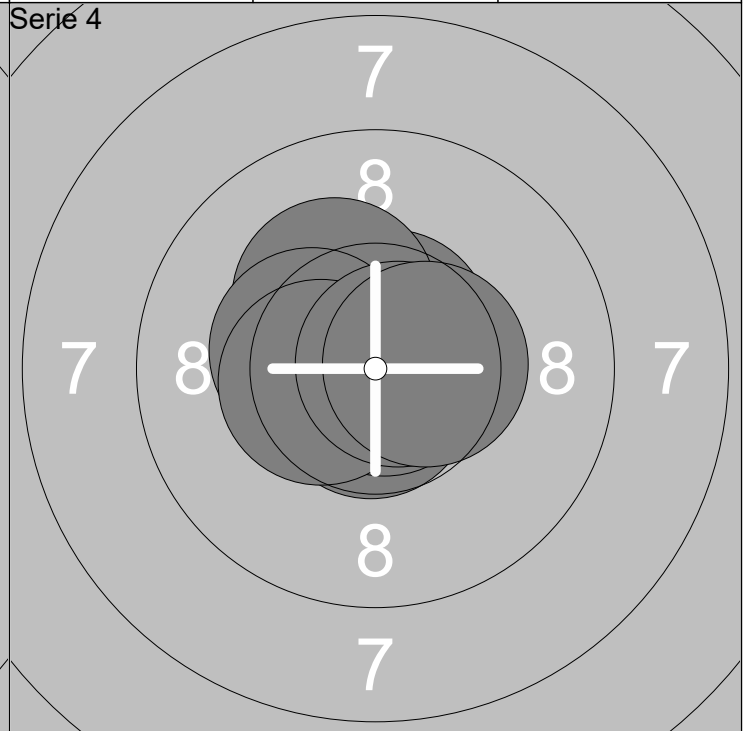
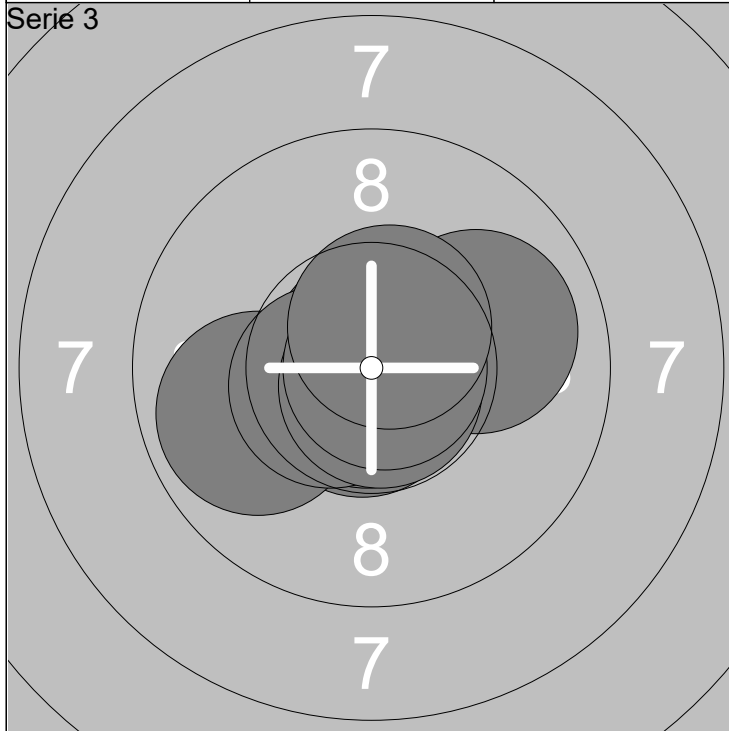

|             |             |       |       |
|-------------|-------------|-------|-------|
| 21: 10.8x ↑ | 26: 10.6x ← | Serie | 105.6 |
| 22: 10.7x ↓ | 27: 10.0 →  |       |       |
| 23: 10.7x ↗ | 28: 10.7x ↓ | Total | 314.9 |
| 24: 10.8x ↓ | 29: 10.8x → |       |       |
| 25: 9.9 ←   | 30: 10.6x ↗ |       |       |

|             |             |       |       |
|-------------|-------------|-------|-------|
| 31: 10.7x ↓ | 36: 10.3x ↖ | Serie | 106.3 |
| 32: 10.8x ↗ | 37: 10.4x ← |       |       |
| 33: 10.9x ↑ | 38: 10.5x ← | Total | 421.2 |
| 34: 10.6x ↑ | 39: 10.7x → |       |       |
| 35: 10.9x → | 40: 10.5x → |       |       |

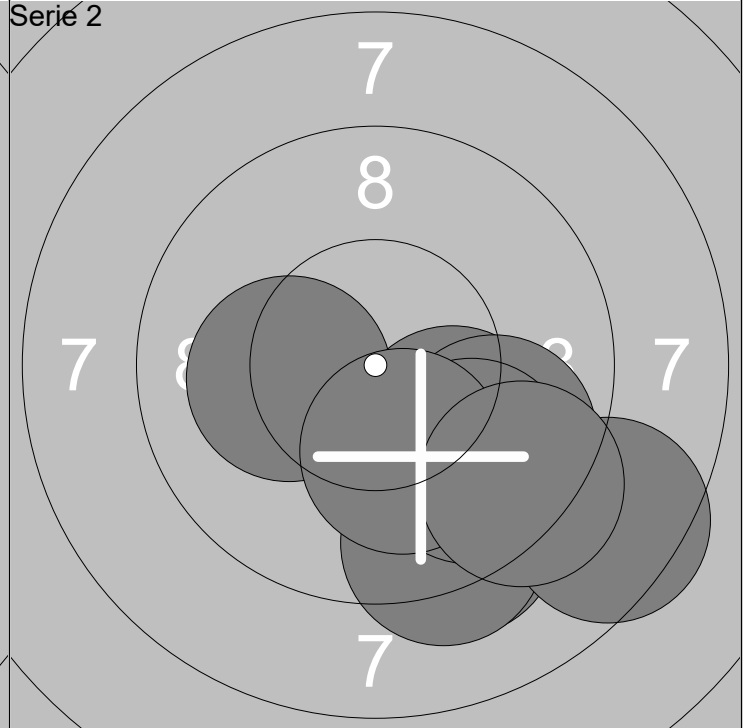
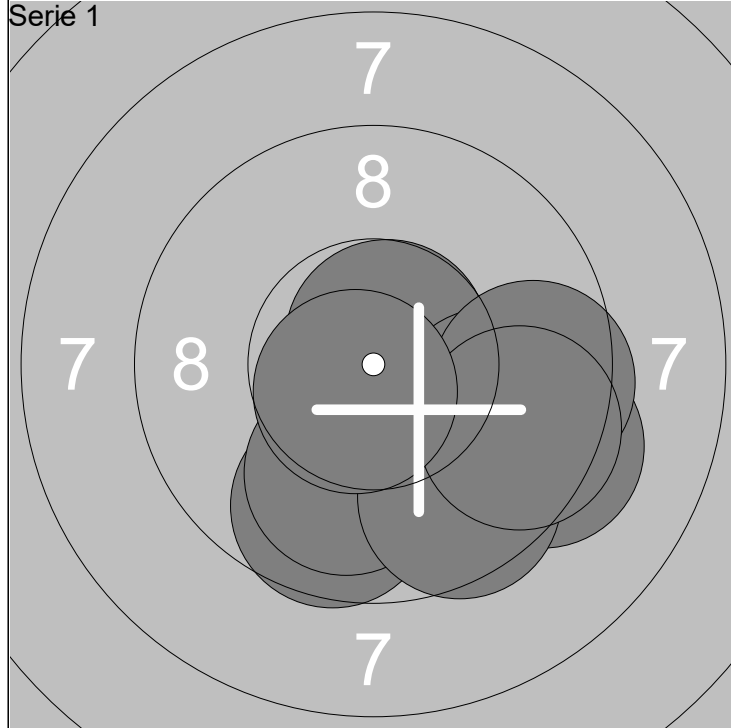

|            |             |       |      |
|------------|-------------|-------|------|
| 1: 10.7x ↗ | 6: 9.7 ↓    | Serie | 99.5 |
| 2: 9.3 →   | 7: 10.0 ↓   |       |      |
| 3: 9.8 →   | 8: 9.6 ↓    | Total | 99.5 |
| 4: 10.6x ↓ | 9: 9.6 →    |       |      |
| 5: 9.5 →   | 10: 10.7x ↓ |       |      |

|             |             |       |       |
|-------------|-------------|-------|-------|
| 11: 10.2x ← | 16: 9.7 ↓   | Serie | 96.0  |
| 12: 9.7 ↓   | 17: 9.8 ↓   |       |       |
| 13: 9.3 ↓   | 18: 10.2x ↓ | Total | 195.5 |
| 14: 9.3 ↓   | 19: 8.5 ↓   |       |       |
| 15: 10.0 ↓  | 20: 9.3 ↓   |       |       |

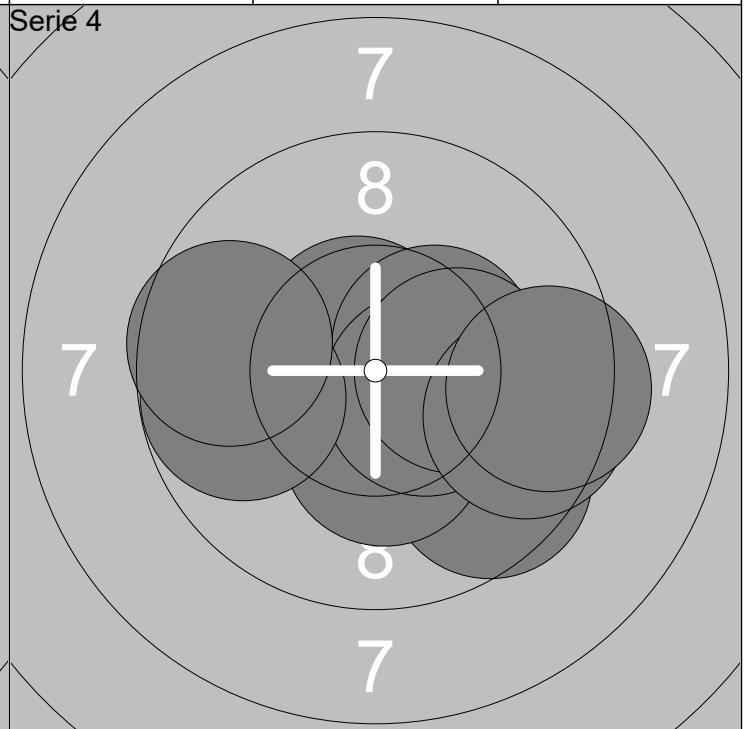
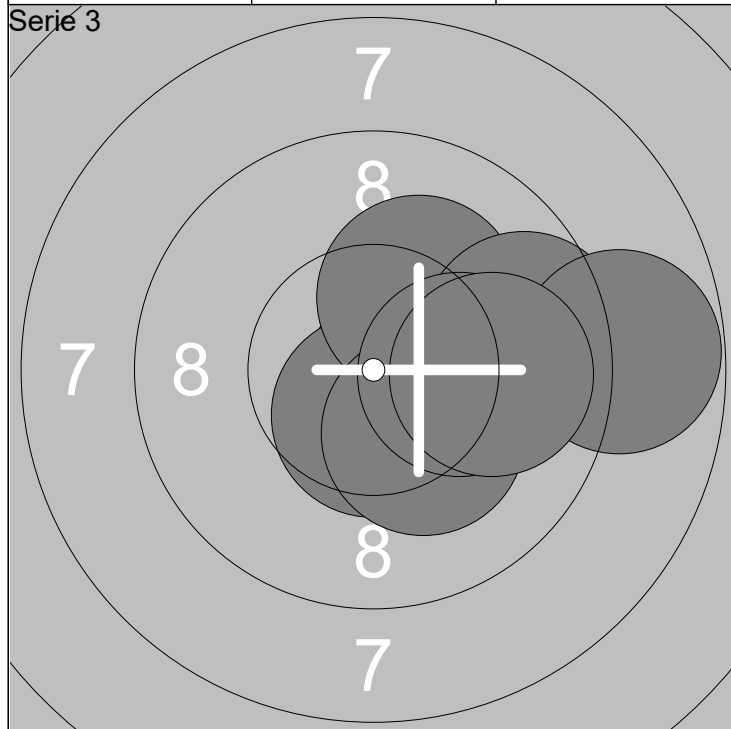

|             |             |       |       |
|-------------|-------------|-------|-------|
| 21: 10.5x ↓ | 26: 9.6 →   | Serie | 100.9 |
| 22: 10.3x → | 27: 8.8 →   |       |       |
| 23: 10.6x → | 28: 10.2x ↓ | Total | 296.4 |
| 24: 10.6x ↓ | 29: 10.2x → |       |       |
| 25: 10.2x ↗ | 30: 9.9 →   |       |       |

|             |             |       |       |
|-------------|-------------|-------|-------|
| 31: 10.6x ↗ | 36: 10.2x → | Serie | 100.0 |
| 32: 9.6 ↓   | 37: 9.8 ←   |       |       |
| 33: 10.4x → | 38: 9.6 →   | Total | 396.4 |
| 34: 10.3x ↓ | 39: 9.4 →   |       |       |
| 35: 10.5x → | 40: 9.6 ←   |       |       |



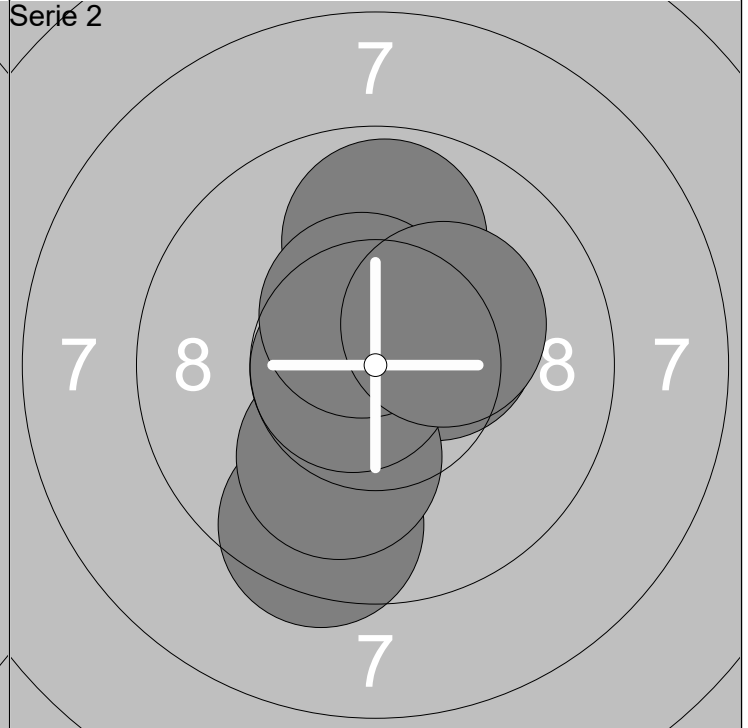
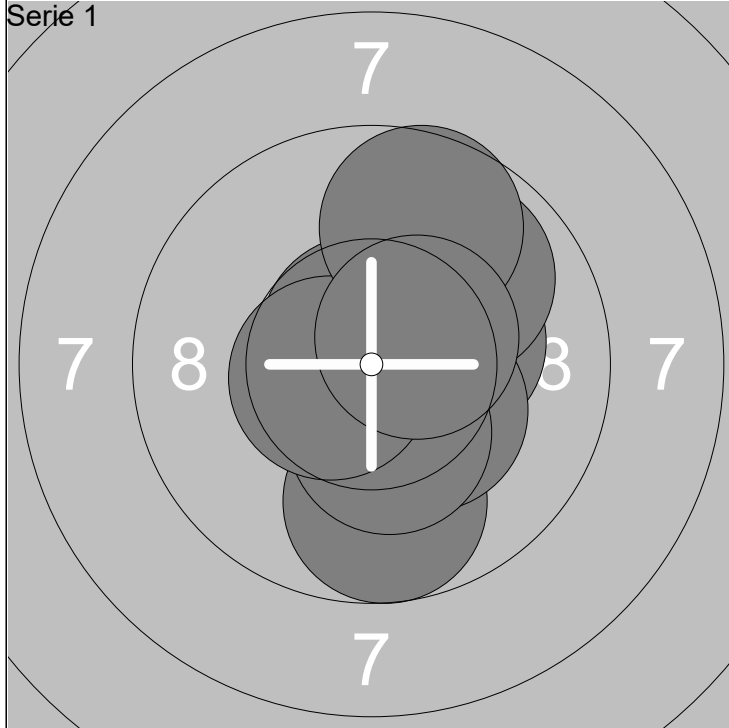

|            |             |       |       |
|------------|-------------|-------|-------|
| 1: 10.7x ↗ | 6: 10.3x ↓  | Serie | 102.6 |
| 2: 10.6x ↓ | 7: 10.6x ←  |       |       |
| 3: 10.3x → | 8: 9.9 ↗    | Total | 102.6 |
| 4: 9.7 ↓   | 9: 9.7 ↗    |       |       |
| 5: 10.3x ↘ | 10: 10.5x ↗ |       |       |

|             |             |       |       |
|-------------|-------------|-------|-------|
| 11: 10.4x ↗ | 16: 9.5 ↓   | Serie | 103.3 |
| 12: 10.8x ↖ | 17: 10.1 ↓  |       |       |
| 13: 9.9 ↑   | 18: 10.7x ← | Total | 205.9 |
| 14: 10.7x ↗ | 19: 10.5x ↗ |       |       |
| 15: 10.4x → | 20: 10.3x ↗ |       |       |

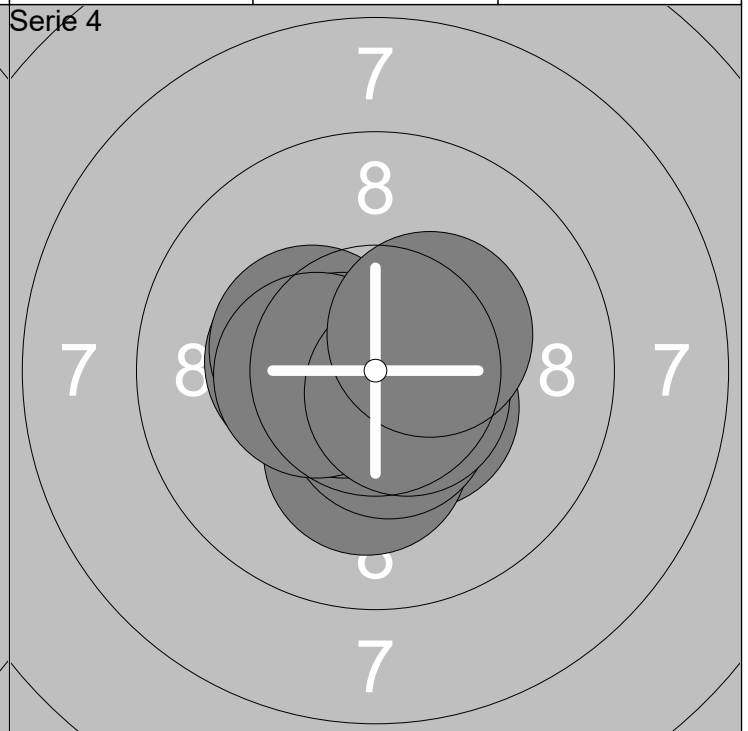
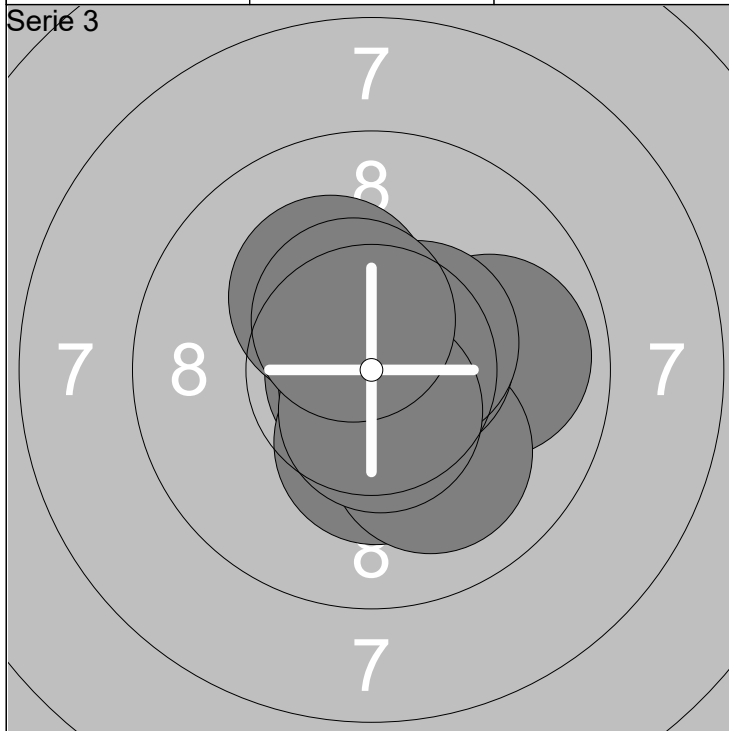

|             |             |       |       |
|-------------|-------------|-------|-------|
| 21: 10.9x ↖ | 26: 10.8x ↘ | Serie | 104.4 |
| 22: 10.3x ↓ | 27: 10.5x ↗ |       |       |
| 23: 9.9 →   | 28: 10.6x ↓ | Total | 310.3 |
| 24: 10.1 ↓  | 29: 10.2x ↗ |       |       |
| 25: 10.6x → | 30: 10.5x ↗ |       |       |

|             |             |       |       |
|-------------|-------------|-------|-------|
| 31: 10.5x ↘ | 36: 10.5x ↓ | Serie | 104.4 |
| 32: 10.3x ← | 37: 10.7x ← |       |       |
| 33: 10.2x ↓ | 38: 10.4x ← | Total | 414.7 |
| 34: 10.5x ↗ | 39: 10.6x ↘ |       |       |
| 35: 10.3x ← | 40: 10.4x ↗ |       |       |

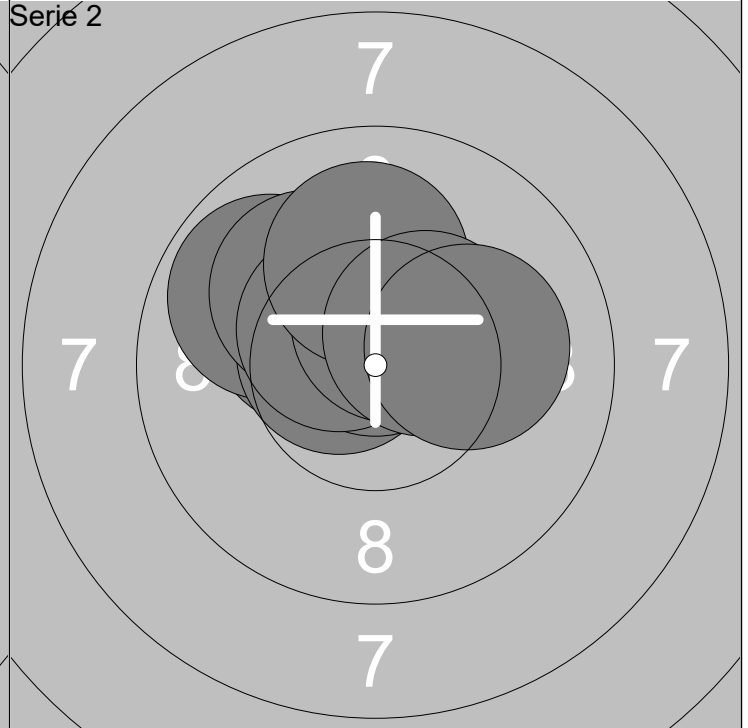
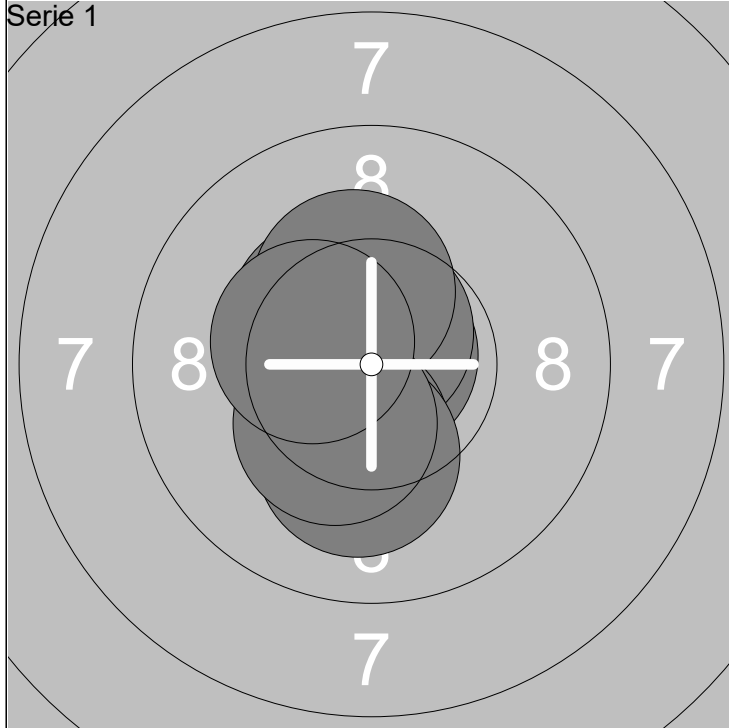

|            |             |                |
|------------|-------------|----------------|
| 1: 10.6x ↙ | 6: 10.3x ↓  | Serie<br>104.2 |
| 2: 10.3x ↑ | 7: 10.1 ↓   |                |
| 3: 10.4x ↖ | 8: 10.3x ↑  | Total<br>104.2 |
| 4: 10.8x ↗ | 9: 10.3x ↓  |                |
| 5: 10.7x ↑ | 10: 10.4x ↖ |                |

|             |             |                |
|-------------|-------------|----------------|
| 11: 10.3x ↖ | 16: 10.5x ↖ | Serie<br>103.3 |
| 12: 9.9 ↖   | 17: 10.5x ↑ |                |
| 13: 10.6x ↖ | 18: 10.1 ↑  | Total<br>207.5 |
| 14: 10.7x ↑ | 19: 10.4x ↗ |                |
| 15: 10.1 ↖  | 20: 10.2x → |                |

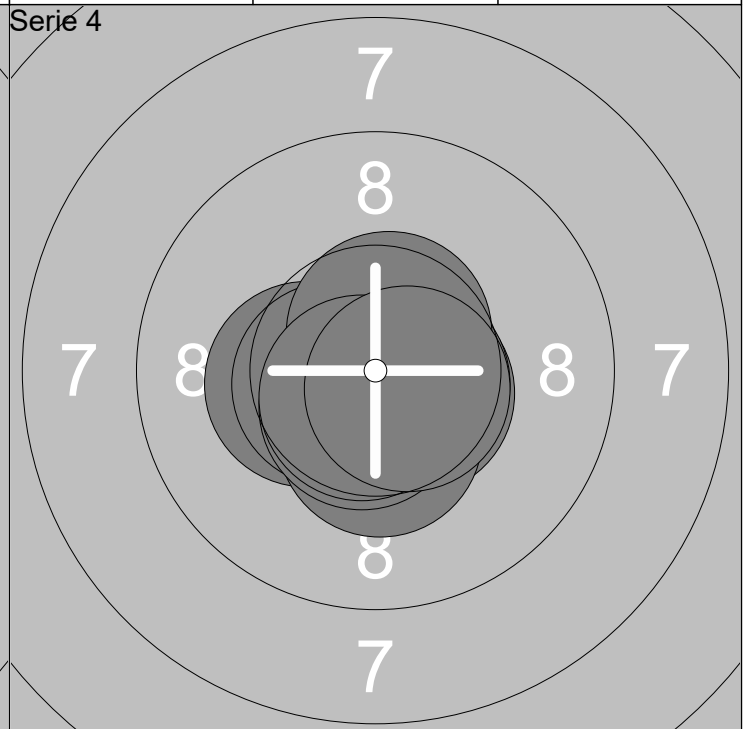
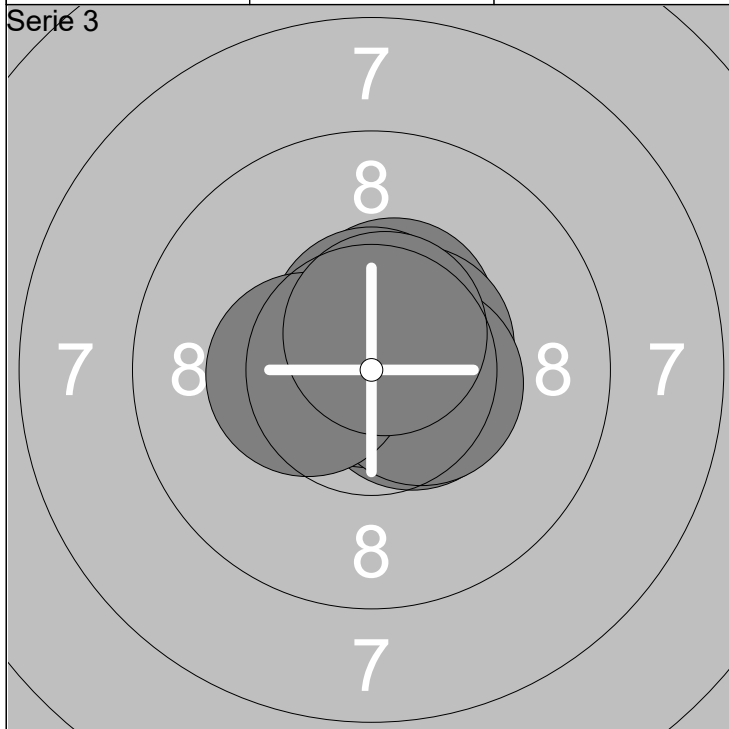

|             |             |                |
|-------------|-------------|----------------|
| 21: 10.5x ↗ | 26: 10.6x ↑ | Serie<br>106.0 |
| 22: 10.6x → | 27: 10.5x → |                |
| 23: 10.9x ↖ | 28: 10.6x ↑ | Total<br>313.5 |
| 24: 10.5x ↗ | 29: 10.4x ← |                |
| 25: 10.8x ↖ | 30: 10.6x ↑ |                |

|             |             |                |
|-------------|-------------|----------------|
| 31: 10.6x → | 36: 10.7x → | Serie<br>106.0 |
| 32: 10.4x ← | 37: 10.6x ↑ |                |
| 33: 10.6x ← | 38: 10.6x ↓ | Total<br>419.5 |
| 34: 10.4x ↓ | 39: 10.7x ↓ |                |
| 35: 10.8x ↗ | 40: 10.6x → |                |

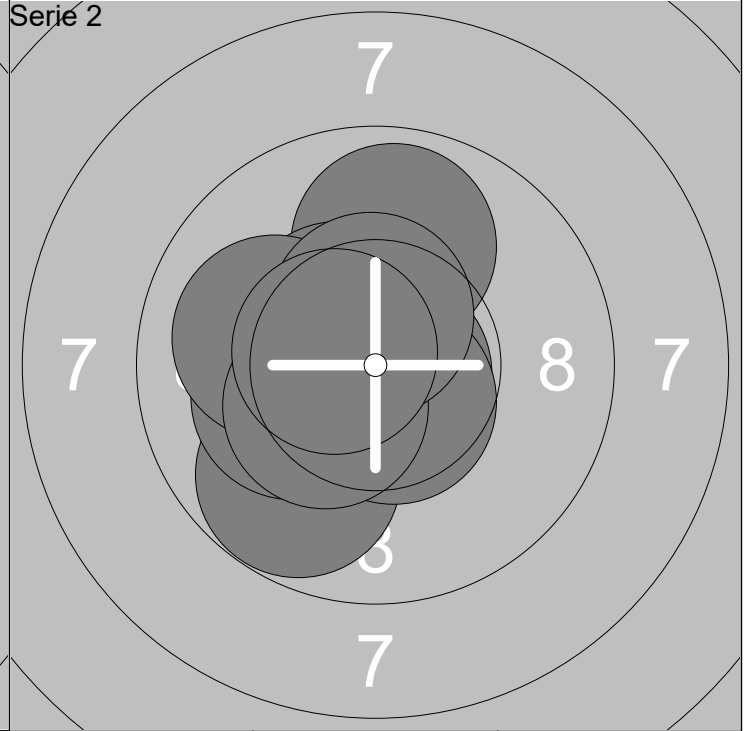
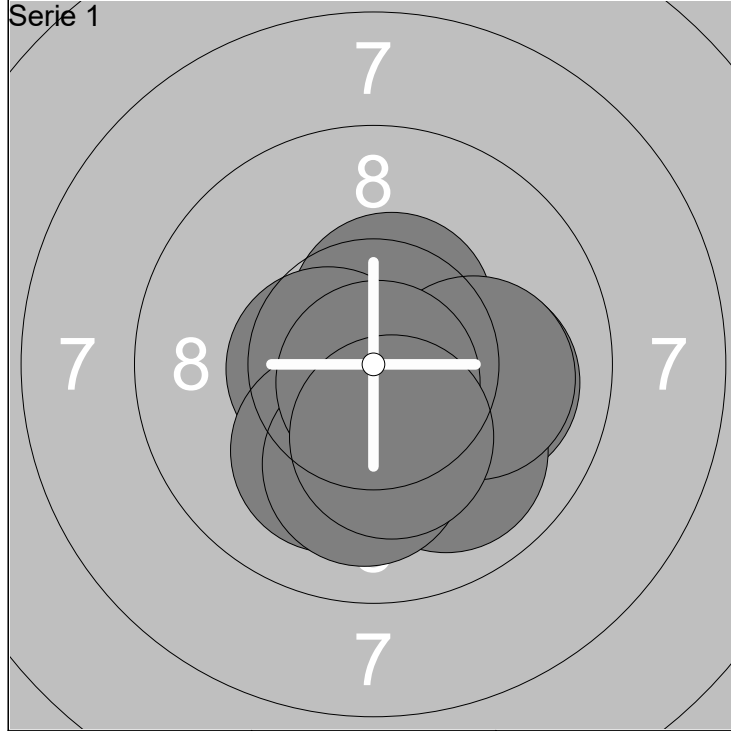

|            |             |       |       |
|------------|-------------|-------|-------|
| 1: 10.4x ↓ | 6: 10.1 ↓   | Serie | 102.7 |
| 2: 10.0 →  | 7: 10.0 →   |       |       |
| 3: 10.0 ↓  | 8: 10.1 ↓   | Total | 102.7 |
| 4: 10.5x ↑ | 9: 10.8x ↓  |       |       |
| 5: 10.5x ← | 10: 10.3x ↓ |       |       |

|             |             |       |       |
|-------------|-------------|-------|-------|
| 11: 9.8 ↓   | 16: 10.6x ↓ | Serie | 103.3 |
| 12: 10.8x → | 17: 10.0 ←  |       |       |
| 13: 10.2x ← | 18: 10.4x ← | Total | 206.0 |
| 14: 9.9 ↑   | 19: 10.5x ↑ |       |       |
| 15: 10.5x ↖ | 20: 10.6x ← |       |       |

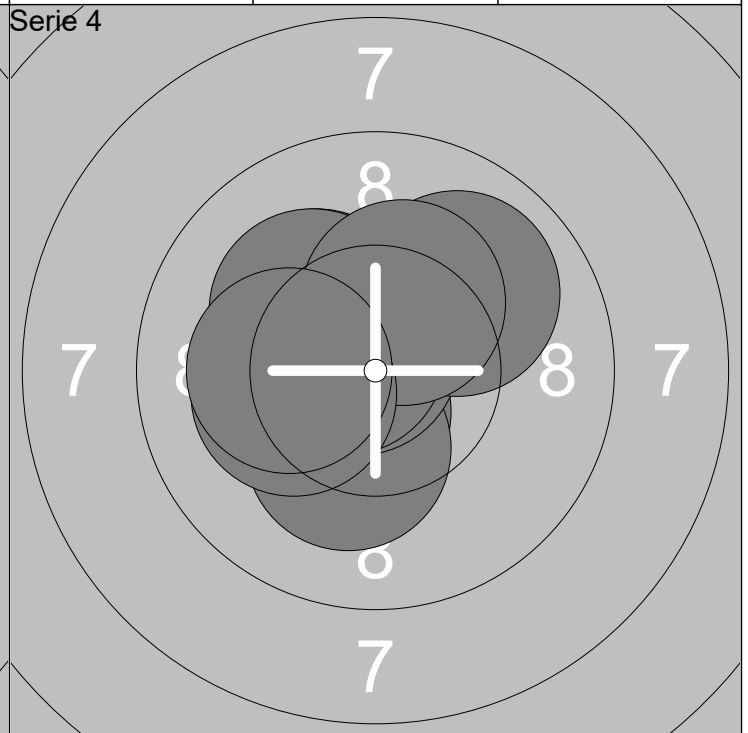
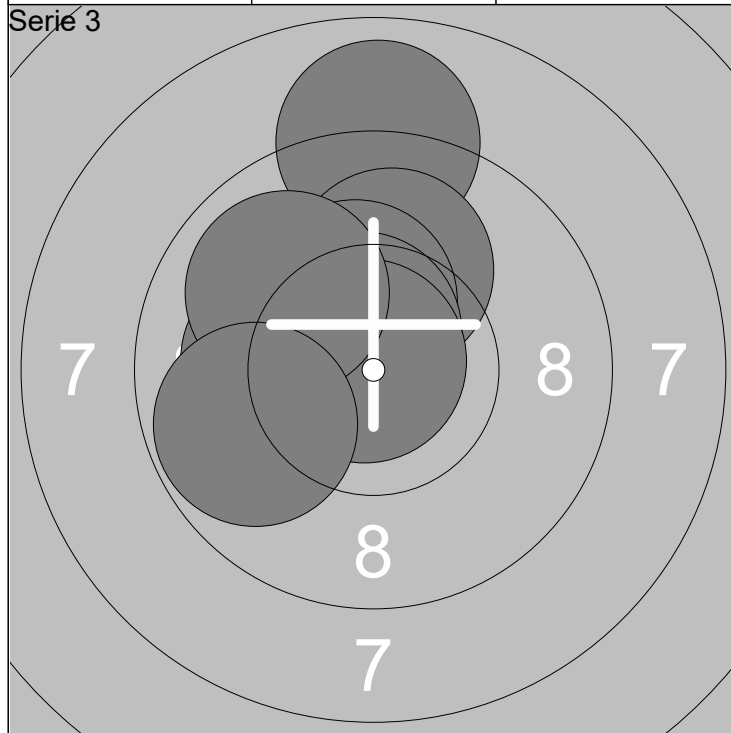

|             |             |       |       |
|-------------|-------------|-------|-------|
| 21: 10.1 ↑  | 26: 10.6x ↑ | Serie | 101.4 |
| 22: 8.9 ↑   | 27: 10.1 ←  |       |       |
| 23: 10.1 ↑  | 28: 10.9x ↖ | Total | 307.4 |
| 24: 10.7x ↖ | 29: 9.9 ↖   |       |       |
| 25: 10.3x ↑ | 30: 9.8 ←   |       |       |

|             |             |       |       |
|-------------|-------------|-------|-------|
| 31: 10.5x ↓ | 36: 10.2x ↖ | Serie | 103.1 |
| 32: 10.2x ↓ | 37: 10.0 ↗  |       |       |
| 33: 10.7x ↖ | 38: 10.3x ↑ | Total | 410.5 |
| 34: 10.2x ↖ | 39: 10.2x ← |       |       |
| 35: 10.6x ↖ | 40: 10.2x ← |       |       |

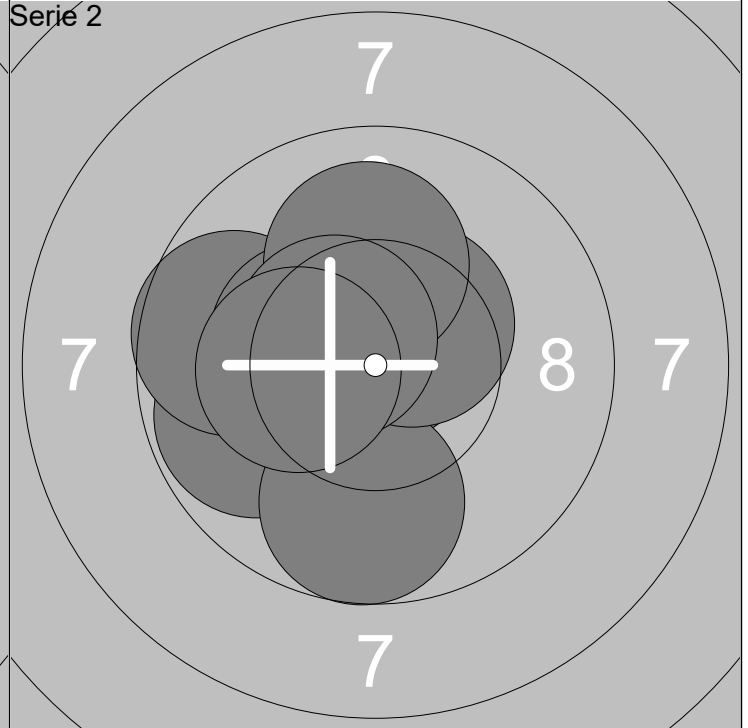
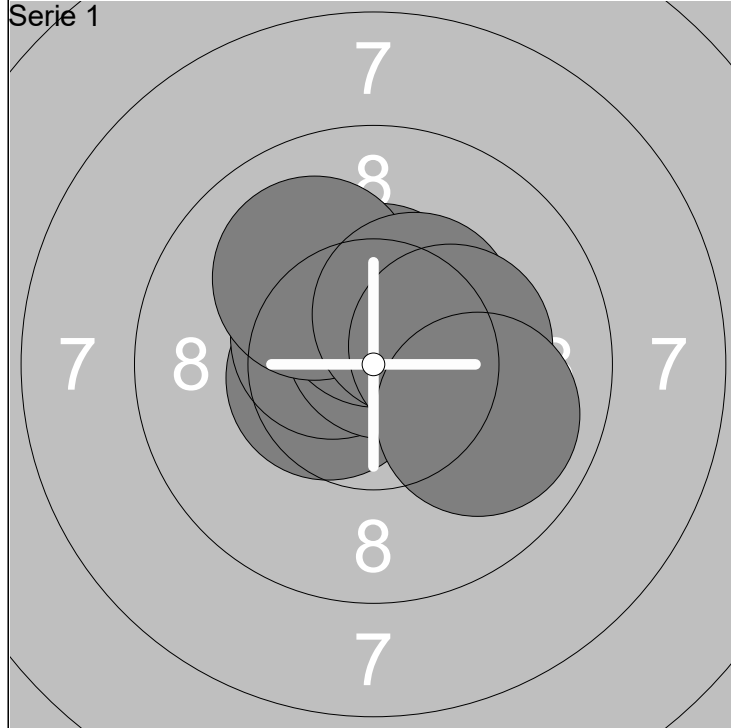

|            |            |       |       |
|------------|------------|-------|-------|
| 1: 10.5x ← | 6: 10.4x ↑ | Serie | 103.5 |
| 2: 10.3x ↗ | 7: 10.0 ↘  |       |       |
| 3: 10.5x ↖ | 8: 10.4x ↗ | Total | 103.5 |
| 4: 10.5x ↗ | 9: 10.3x → |       |       |
| 5: 10.7x ↗ | 10: 9.9 ↘  |       |       |

|             |             |       |       |
|-------------|-------------|-------|-------|
| 11: 10.5x ← | 16: 10.4x ← | Serie | 102.3 |
| 12: 10.7x ↑ | 17: 10.5x ↗ |       |       |
| 13: 9.8 ←   | 18: 10.1 ↑  | Total | 205.8 |
| 14: 9.8 ↓   | 19: 10.5x ↖ |       |       |
| 15: 9.7 ←   | 20: 10.3x ← |       |       |

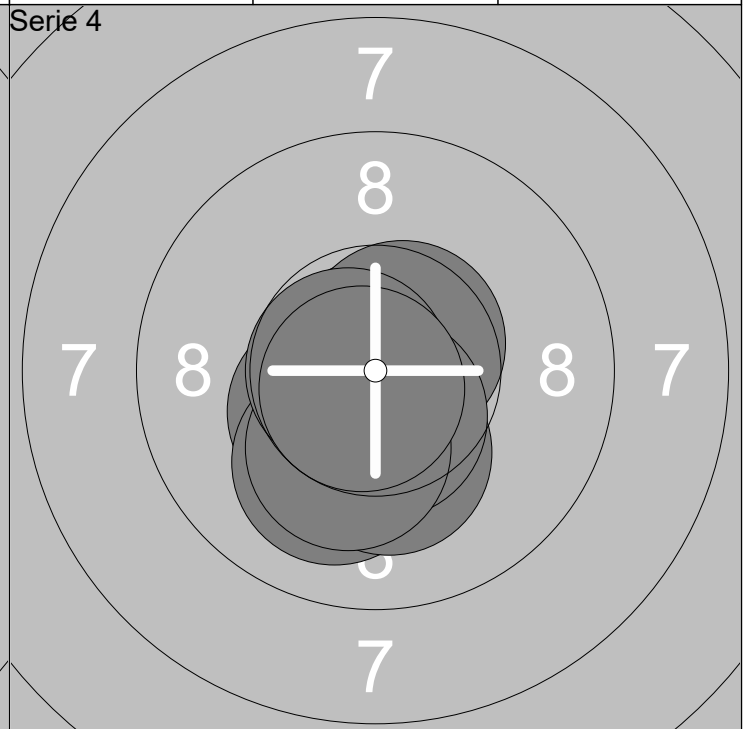
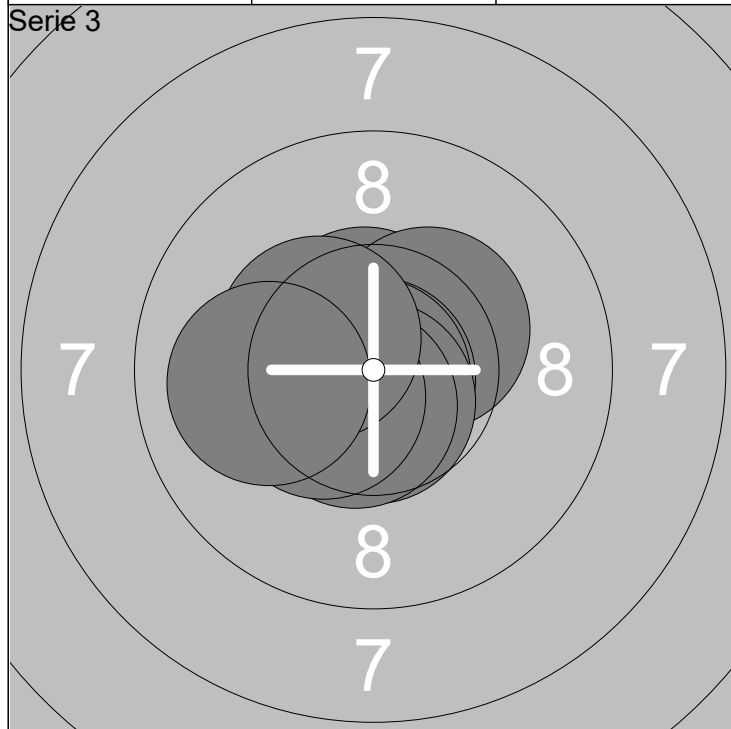

|             |             |       |       |
|-------------|-------------|-------|-------|
| 21: 10.6x ↑ | 26: 10.7x ↓ | Serie | 105.6 |
| 22: 10.3x ↗ | 27: 10.6x ↓ |       |       |
| 23: 10.9x ↓ | 28: 10.4x ← | Total | 311.4 |
| 24: 10.8x ↓ | 29: 10.4x ↖ |       |       |
| 25: 10.9x ↓ | 30: 10.0 ←  |       |       |

|             |             |       |       |
|-------------|-------------|-------|-------|
| 31: 10.5x ↓ | 36: 10.6x ↗ | Serie | 104.7 |
| 32: 10.9x ↑ | 37: 10.5x ↓ |       |       |
| 33: 10.4x ↖ | 38: 10.2x ↓ | Total | 416.1 |
| 34: 10.0 ↓  | 39: 10.7x ← |       |       |
| 35: 10.2x ↓ | 40: 10.7x ↓ |       |       |

Serie 1

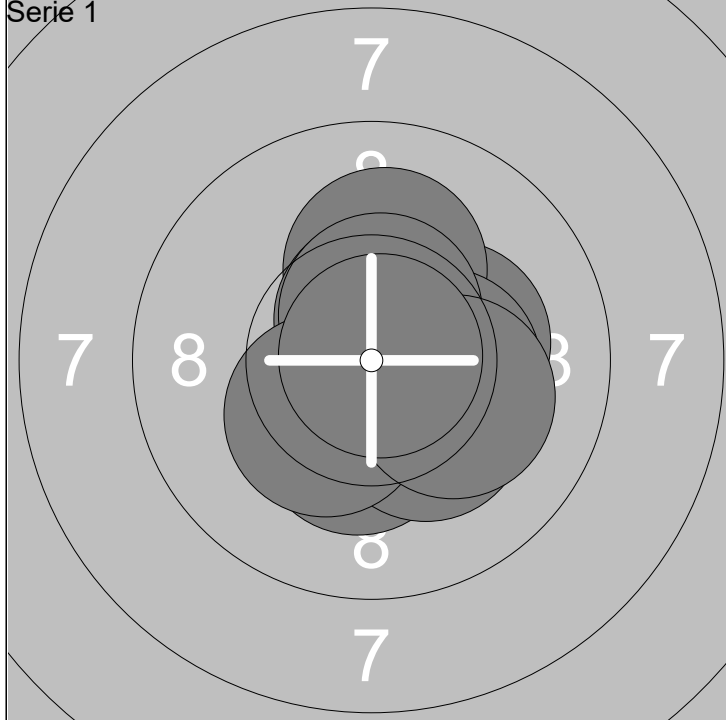

Serie 2

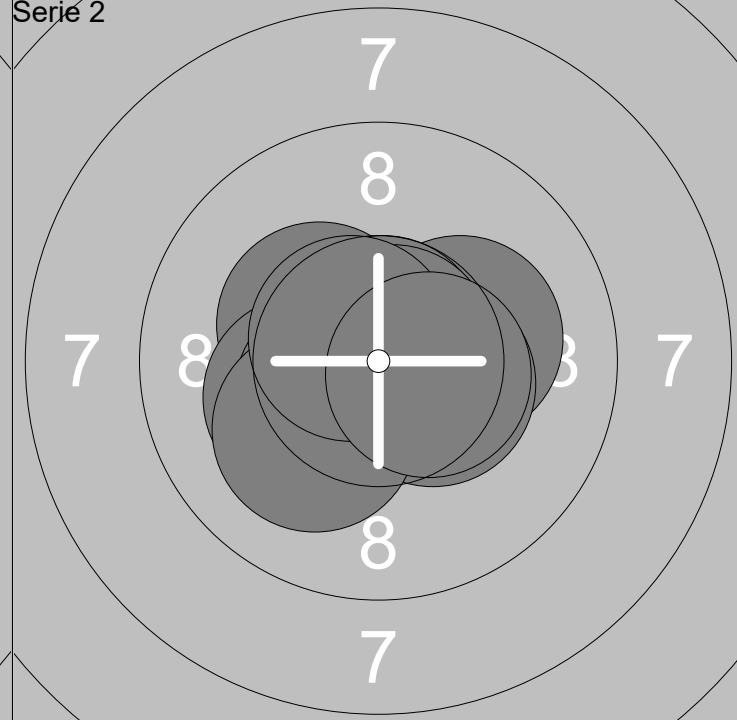

|            |             |
|------------|-------------|
| 1: 10.3x → | 6: 10.6x ↑  |
| 2: 10.1 ↑  | 7: 10.6x ↑  |
| 3: 10.3x ↓ | 8: 10.3x ↙  |
| 4: 10.3x → | 9: 10.2x →  |
| 5: 10.2x ↘ | 10: 10.9x ↗ |

|       |       |
|-------|-------|
| Serie | 103.8 |
| Total | 103.8 |

|             |             |
|-------------|-------------|
| 11: 10.2x → | 16: 10.5x ↙ |
| 12: 10.3x ↖ | 17: 10.1 ↙  |
| 13: 10.2x ↙ | 18: 10.8x ↗ |
| 14: 10.4x → | 19: 10.6x ↖ |
| 15: 10.7x ↑ | 20: 10.5x → |

|       |       |
|-------|-------|
| Serie | 104.3 |
| Total | 208.1 |

Serie 3

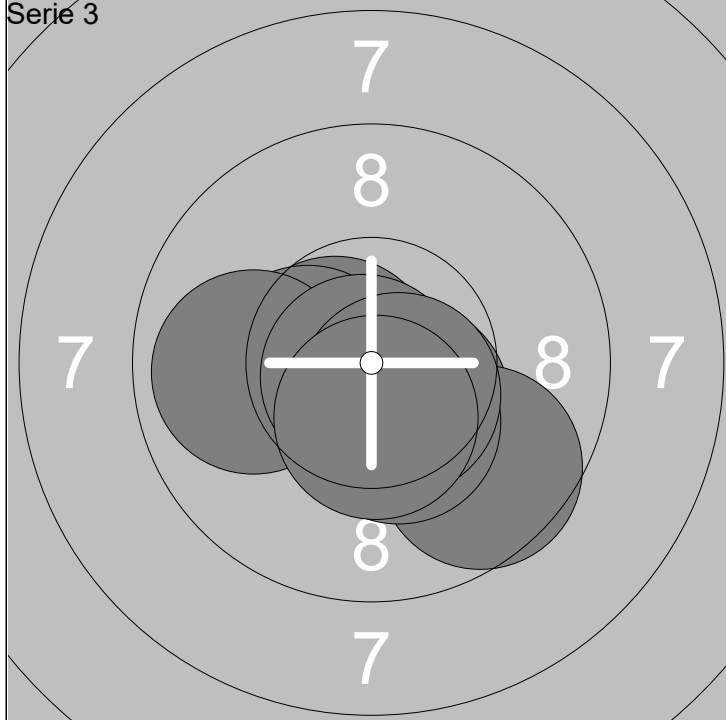

Serie 4

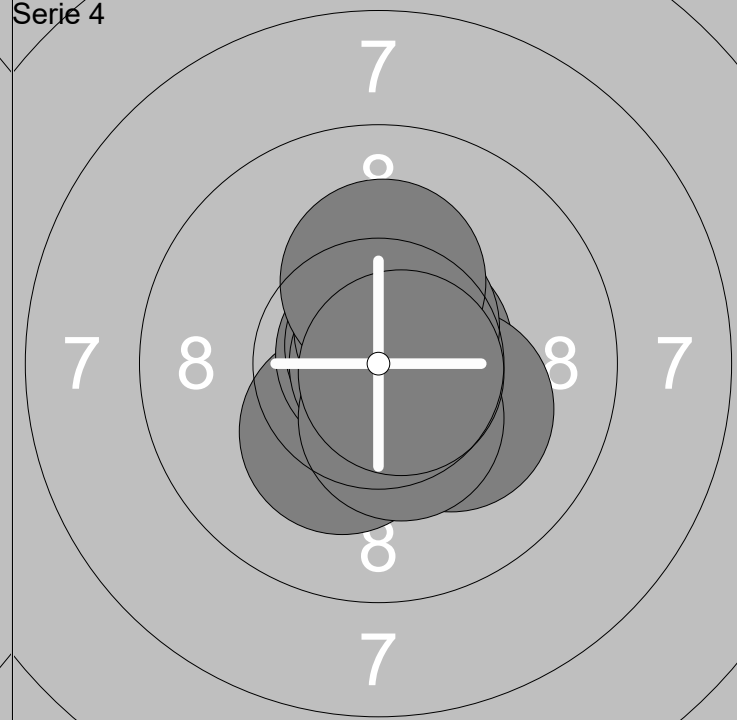

|             |             |
|-------------|-------------|
| 21: 10.5x ↘ | 26: 9.9 ←   |
| 22: 10.6x ← | 27: 10.4x ↓ |
| 23: 9.6 ↘   | 28: 10.8x ↙ |
| 24: 10.6x ↓ | 29: 10.6x ↘ |
| 25: 10.4x ← | 30: 10.5x ↓ |

|       |       |
|-------|-------|
| Serie | 103.9 |
| Total | 312.0 |

|             |             |
|-------------|-------------|
| 31: 10.6x ↗ | 36: 10.8x → |
| 32: 10.3x ↙ | 37: 10.4x ↓ |
| 33: 10.9x ↑ | 38: 10.6x ↗ |
| 34: 10.2x → | 39: 10.2x ↑ |
| 35: 10.8x ↗ | 40: 10.7x → |

|       |       |
|-------|-------|
| Serie | 105.5 |
| Total | 417.5 |

Skjutlag

Tavla

2

9

Filippa Björnqvist

Grund

L11

10.12.2016

Zonfinal Kronobergs län

Söraby SKF

Serie 1

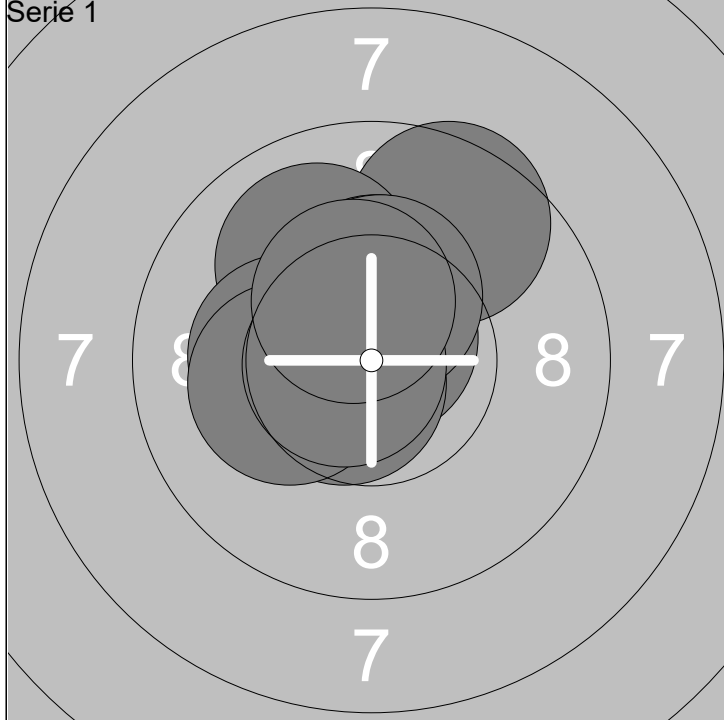

Serie 2

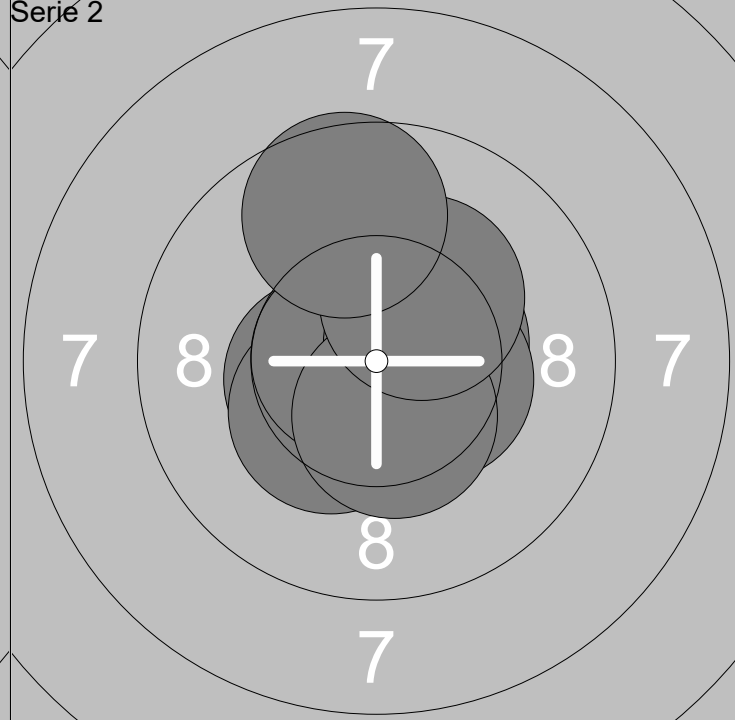

1: 9.6 ↗  
2: 10.0 ↖  
3: 10.7x ↑  
4: 10.6x ↙  
5: 10.4x ↑

6: 10.4x ↑  
7: 10.2x ←  
8: 10.2x ←  
9: 10.7x ←  
10: 10.4x ↑

Serie 103.2  
Total 103.2

11: 10.8x ↓  
12: 10.7x ↓  
13: 10.5x ←  
14: 10.3x ↙  
15: 10.8x ←

16: 10.5x →  
17: 10.4x →  
18: 10.4x ↓  
19: 10.3x ↗  
20: 9.6 ↑

Serie 104.3  
Total 207.5

Serie 3

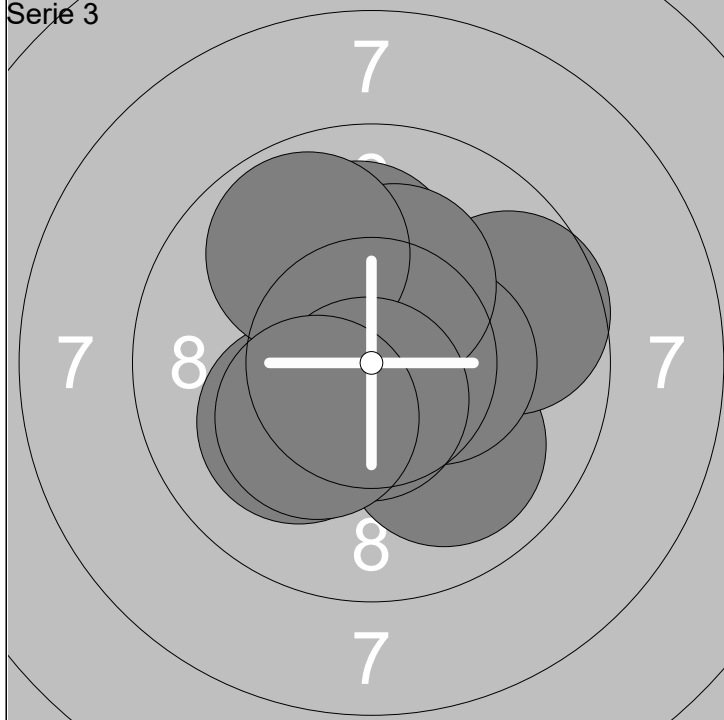

Serie 4

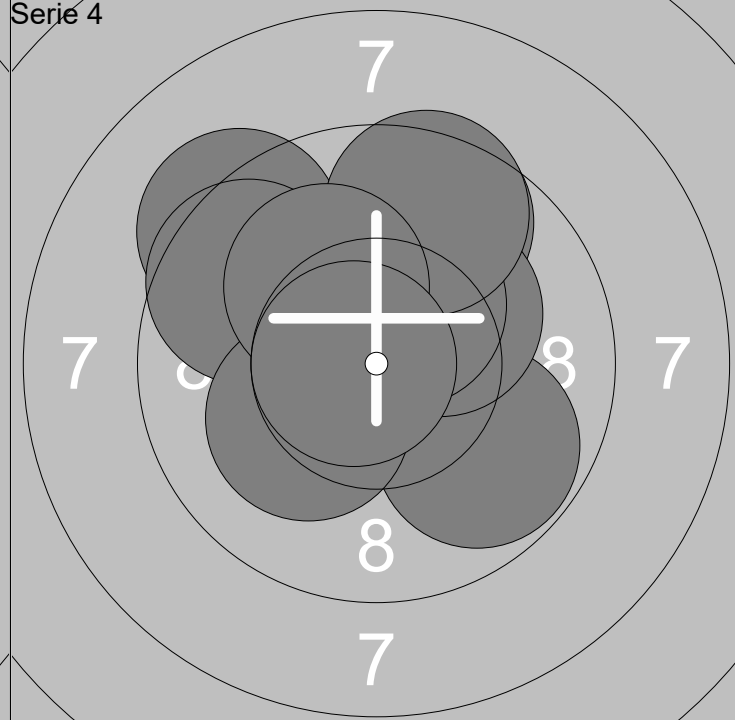

21: 10.0 ↘  
22: 10.1 ↑  
23: 10.5x ↑  
24: 9.7 →  
25: 10.4x →

26: 10.1 ←  
27: 10.2x ↑  
28: 9.9 ↖  
29: 10.6x ↓  
30: 10.3x ↙

Serie 101.8  
Total 309.3

31: 9.6 ↑  
32: 9.8 ↘  
33: 9.3 ↖  
34: 9.6 ↖  
35: 10.2x ↙

36: 10.2x ↗  
37: 10.4x ↑  
38: 9.6 ↑  
39: 10.2x ↖  
40: 10.7x ←

Serie 99.6  
Total 408.9

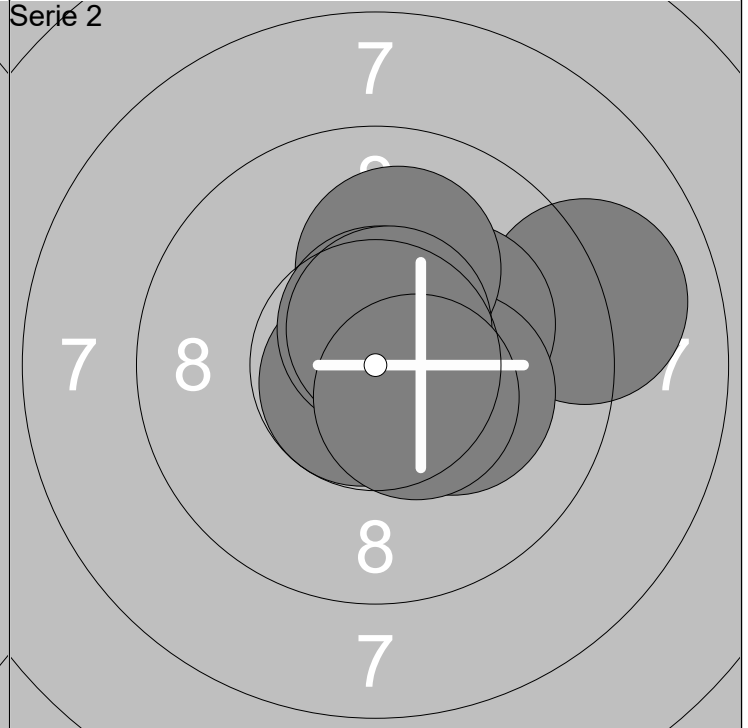
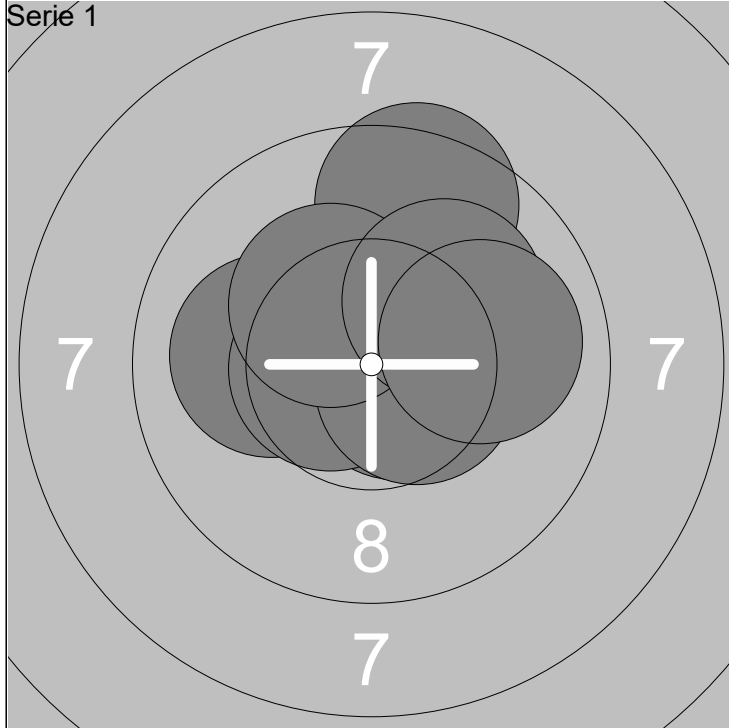

|            |            |       |       |
|------------|------------|-------|-------|
| 1: 10.6x ↖ | 6: 9.5 ↗   | Serie | 103.0 |
| 2: 10.6x ↗ | 7: 10.5x → |       |       |
| 3: 10.1 ←  | 8: 10.3x ↖ | Total | 103.0 |
| 4: 10.7x → | 9: 10.1 ↗  |       |       |
| 5: 10.6x ← | 10: 10.0 → |       |       |

|             |             |       |       |
|-------------|-------------|-------|-------|
| 11: 10.8x → | 16: 10.1 ↗  | Serie | 103.0 |
| 12: 10.2x → | 17: 10.8x ↘ |       |       |
| 13: 9.0 →   | 18: 10.6x ↗ | Total | 206.0 |
| 14: 10.2x ↗ | 19: 10.6x ↗ |       |       |
| 15: 10.2x → | 20: 10.5x ↘ |       |       |

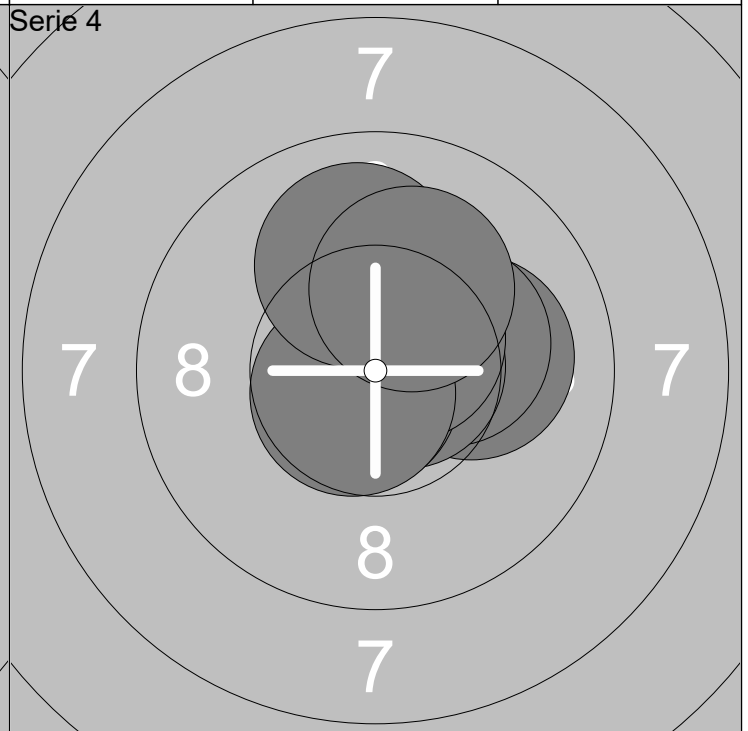
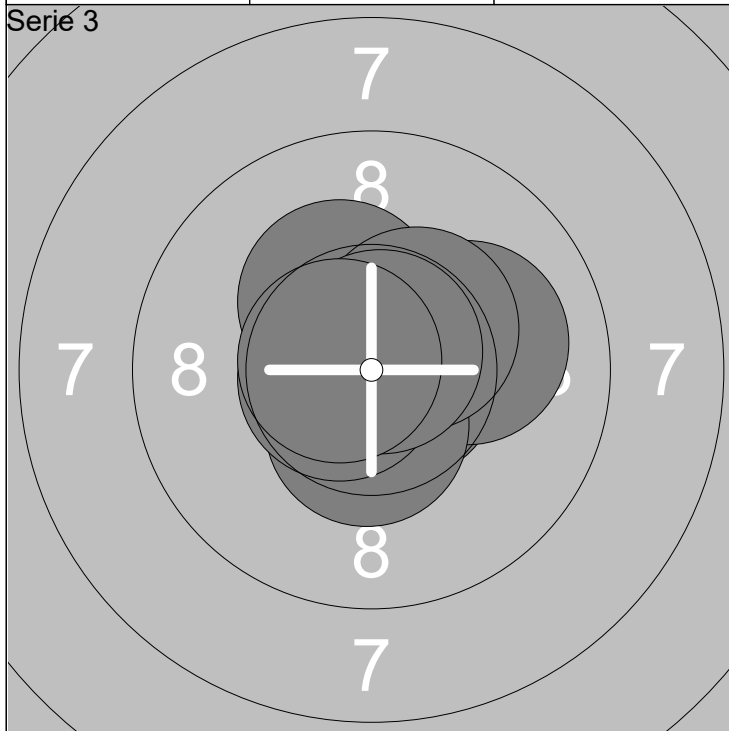

|             |             |       |       |
|-------------|-------------|-------|-------|
| 21: 10.7x → | 26: 10.5x ↓ | Serie | 105.7 |
| 22: 10.9x → | 27: 10.7x ← |       |       |
| 23: 10.7x ↗ | 28: 10.4x ↗ | Total | 311.7 |
| 24: 10.3x ↖ | 29: 10.8x ↗ |       |       |
| 25: 10.1 →  | 30: 10.6x ← |       |       |

|             |             |       |       |
|-------------|-------------|-------|-------|
| 31: 10.1 →  | 36: 10.5x ↗ | Serie | 104.2 |
| 32: 10.3x → | 37: 10.6x ↗ |       |       |
| 33: 10.7x → | 38: 10.7x ↘ | Total | 415.9 |
| 34: 10.7x ↘ | 39: 10.0 ↗  |       |       |
| 35: 10.4x ↗ | 40: 10.2x ↗ |       |       |

Skjutlag

Tavla

2

13

Max Björnqvist

Grund

L13

10.12.2016

Zonfinal Kronobergs län

Söraby SKF

Serie 1

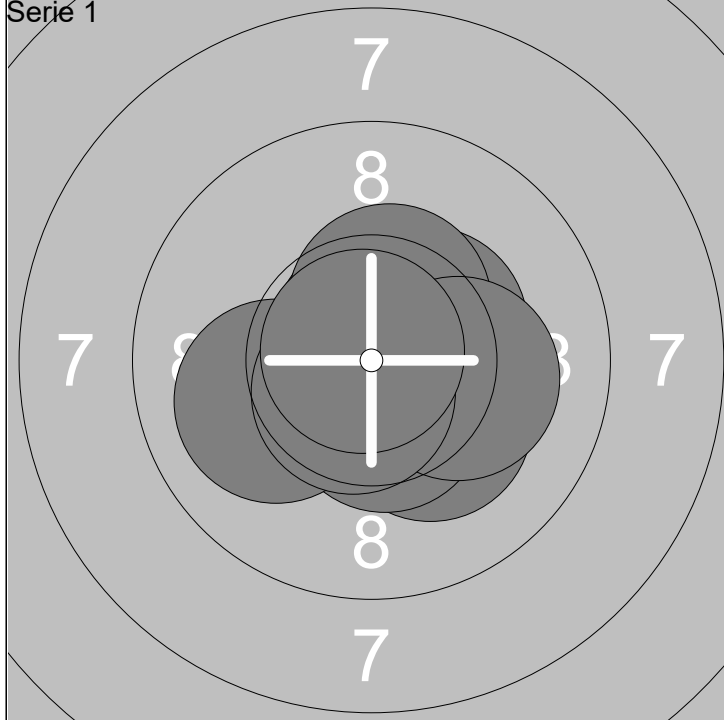

Serie 2

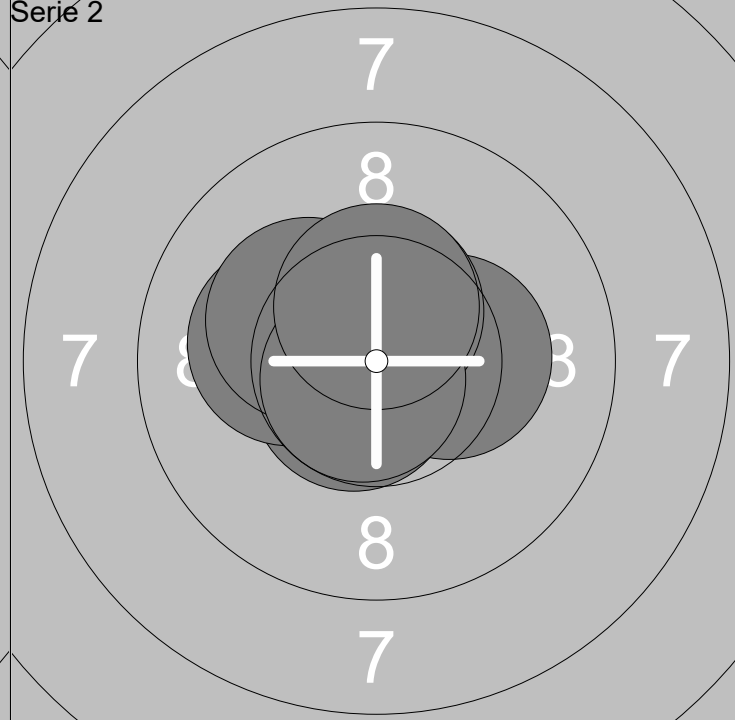

|            |             |
|------------|-------------|
| 1: 10.7x ↑ | 6: 10.5x ↓  |
| 2: 10.6x → | 7: 10.0 ←   |
| 3: 10.4x ↗ | 8: 10.2x →  |
| 4: 10.2x ↘ | 9: 10.6x ↓  |
| 5: 10.5x ↑ | 10: 10.8x ↖ |

|       |       |
|-------|-------|
| Serie | 104.5 |
| Total | 104.5 |

|             |             |
|-------------|-------------|
| 11: 10.2x ← | 16: 10.5x ↑ |
| 12: 10.7x ↓ | 17: 10.6x ← |
| 13: 10.2x ← | 18: 10.3x ↖ |
| 14: 10.7x ↑ | 19: 10.7x ↓ |
| 15: 10.3x → | 20: 10.4x ↑ |

|       |       |
|-------|-------|
| Serie | 104.6 |
| Total | 209.1 |

Serie 3

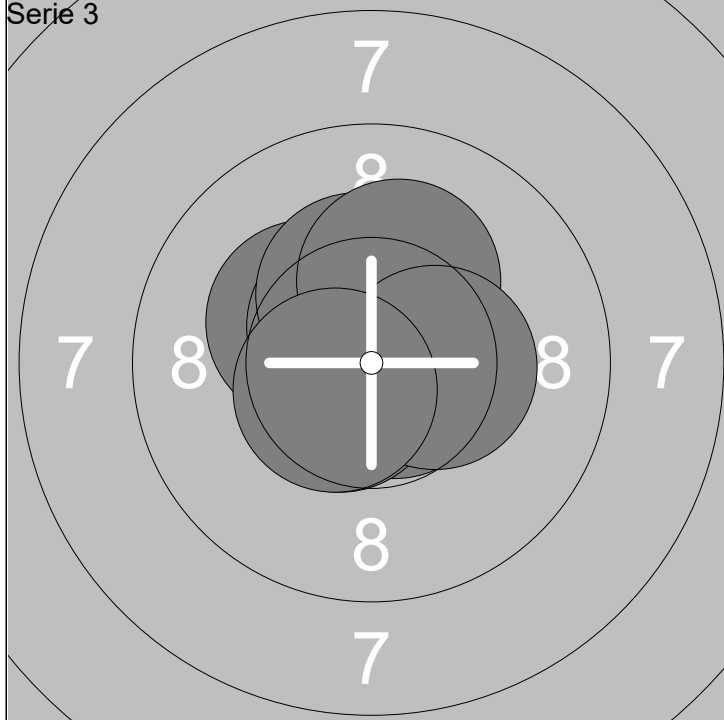

Serie 4

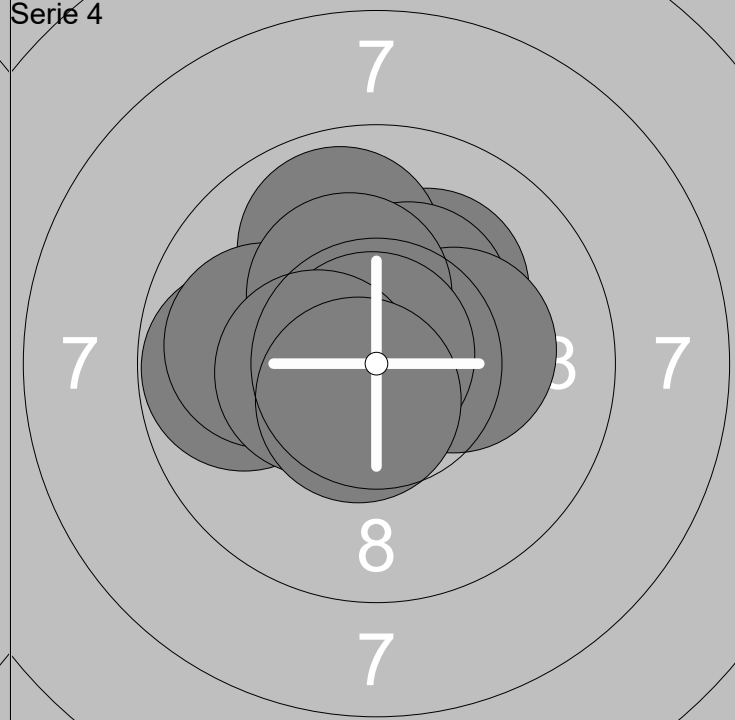

|             |             |
|-------------|-------------|
| 21: 10.7x ↘ | 26: 10.6x ↖ |
| 22: 10.8x ↖ | 27: 10.3x ↑ |
| 23: 10.3x ↖ | 28: 10.2x ↑ |
| 24: 10.6x ↙ | 29: 10.4x → |
| 25: 10.6x ↑ | 30: 10.5x ↙ |

|       |       |
|-------|-------|
| Serie | 105.0 |
| Total | 314.1 |

|             |             |
|-------------|-------------|
| 31: 10.2x ↗ | 36: 10.0 ←  |
| 32: 9.9 ↑   | 37: 10.3x ↖ |
| 33: 10.3x ↗ | 38: 10.9x ↖ |
| 34: 9.8 ←   | 39: 10.4x ← |
| 35: 10.3x → | 40: 10.6x ↓ |

|       |       |
|-------|-------|
| Serie | 102.7 |
| Total | 416.8 |



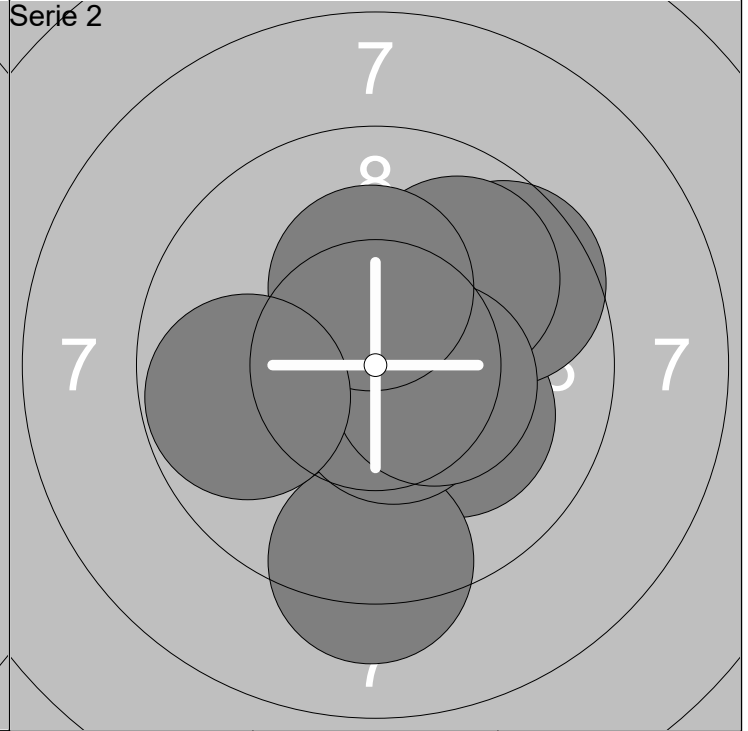
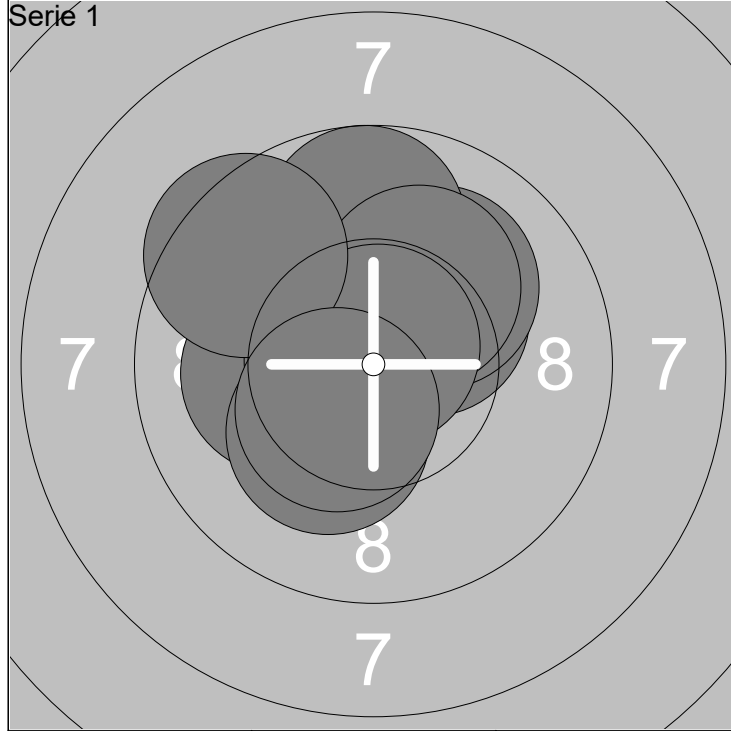

|            |             |       |       |
|------------|-------------|-------|-------|
| 1: 10.2x ← | 6: 10.1 ↗   | Serie | 102.2 |
| 2: 10.3x ↗ | 7: 10.7x ←  |       |       |
| 3: 10.3x ↘ | 8: 10.8x ↗  | Total | 102.2 |
| 4: 10.1 ↗  | 9: 9.5 ↘    |       |       |
| 5: 9.8 ↗   | 10: 10.4x ↘ |       |       |

|             |             |       |       |
|-------------|-------------|-------|-------|
| 11: 10.1 ↘  | 16: 9.6 ↗   | Serie | 100.6 |
| 12: 9.2 ↓   | 17: 9.9 ↗   |       |       |
| 13: 10.3x ↗ | 18: 10.4x → | Total | 202.8 |
| 14: 10.6x ↘ | 19: 10.3x ↗ |       |       |
| 15: 10.4x ↗ | 20: 9.8 ←   |       |       |

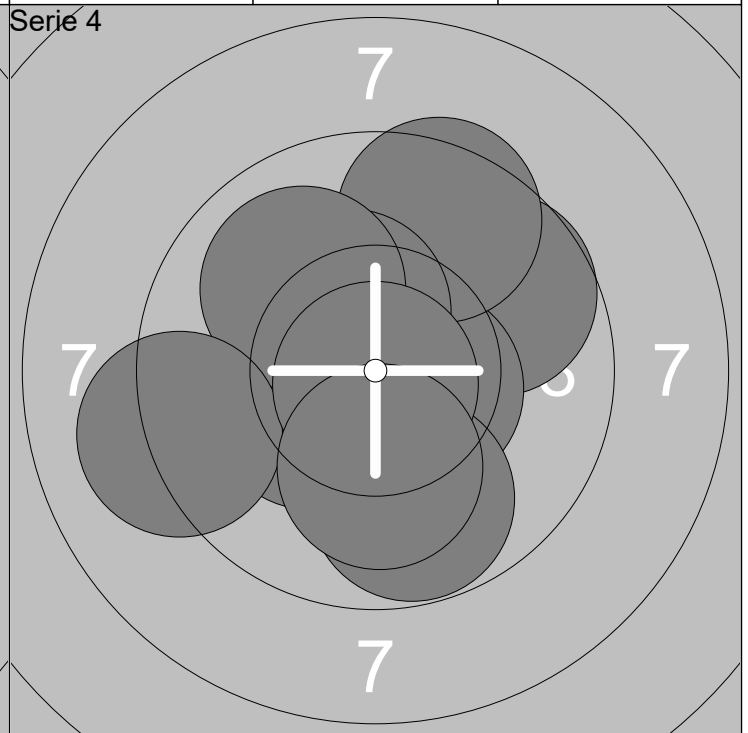
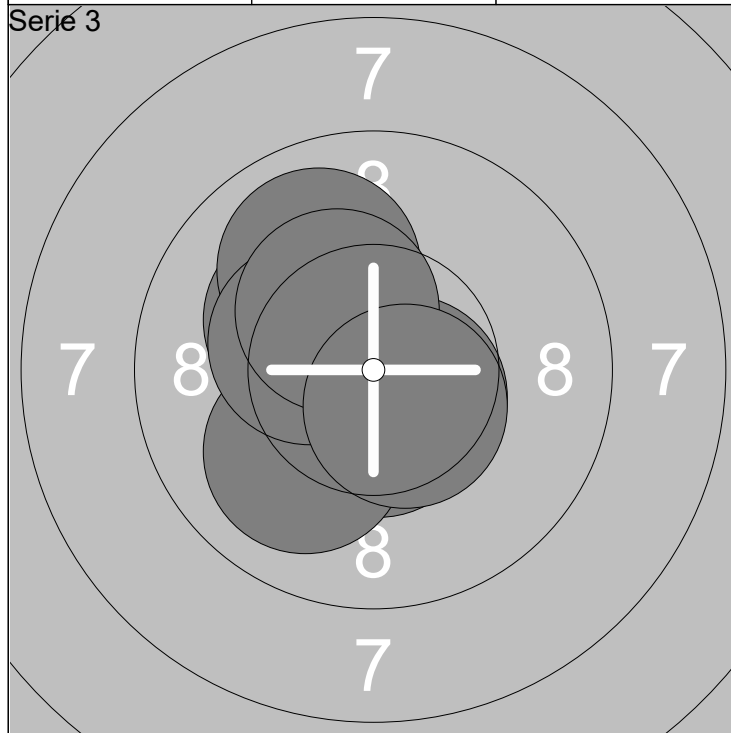

|             |             |       |       |
|-------------|-------------|-------|-------|
| 21: 10.6x ↘ | 26: 9.9 ↗   | Serie | 103.9 |
| 22: 10.6x ↘ | 27: 10.0 ↘  |       |       |
| 23: 10.6x ↓ | 28: 10.3x ← | Total | 306.7 |
| 24: 10.2x ↗ | 29: 10.4x ↗ |       |       |
| 25: 10.8x ← | 30: 10.5x ↘ |       |       |

|             |             |       |       |
|-------------|-------------|-------|-------|
| 31: 9.7 ↗   | 36: 9.8 ↓   | Serie | 100.2 |
| 32: 10.5x → | 37: 10.0 ↘  |       |       |
| 33: 9.5 ↗   | 38: 9.1 ←   | Total | 406.9 |
| 34: 10.3x ← | 39: 10.8x ↓ |       |       |
| 35: 10.4x ↗ | 40: 10.1 ↓  |       |       |

Skjutlag

Tavla

3

2

Amanda Berglund

Grund

L13s

10.12.2016

Zonfinal Kronobergs län

Söraby SKF

Serie 1

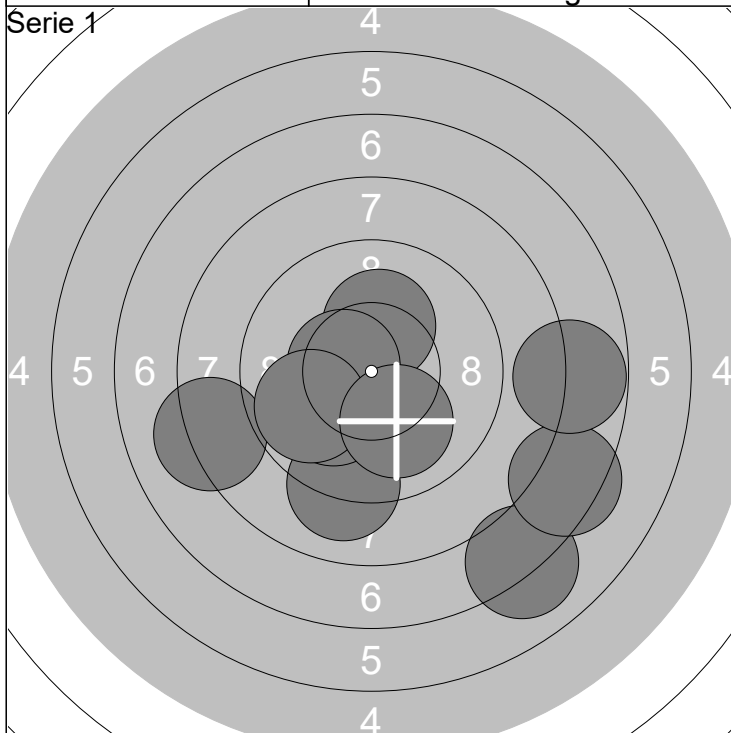

1: 9.1 ↓  
2: 10.2x ↑  
3: 10.1 ↙  
4: 7.1 ↘  
5: 7.4 ↘

6: 8.2 ←  
7: 10.5x ←  
8: 7.8 →  
9: 9.9 ←  
10: 10.1 ↓

Serie 90.4

Total 90.4

Serie 2

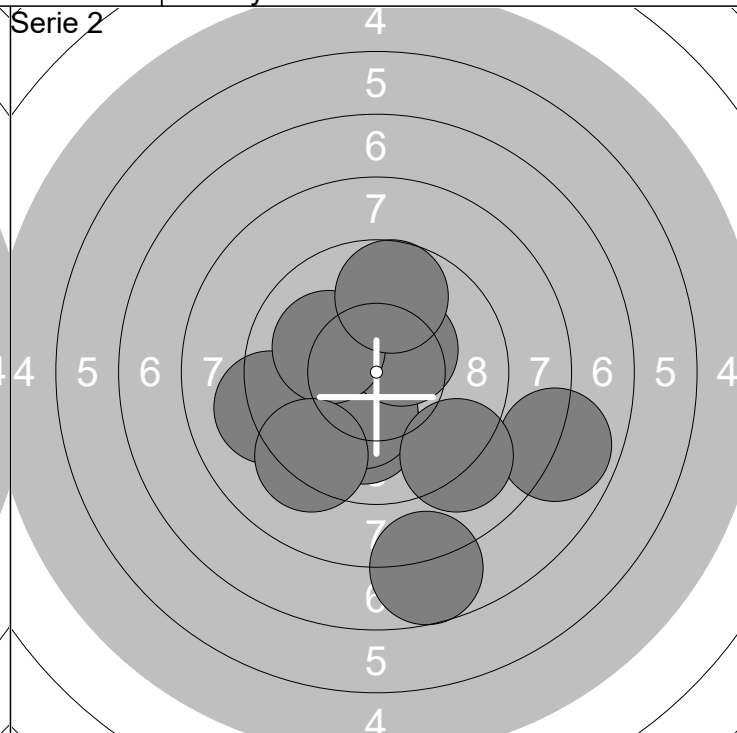

11: 10.0 ↓  
12: 10.2x ↓  
13: 7.7 ↓  
14: 7.9 →  
15: 9.2 ←

16: 10.4x ↗  
17: 10.1 ↙  
18: 9.1 ↘  
19: 9.3 ↘  
20: 9.7 ↑

Serie 93.6

Total 184.0

Serie 3

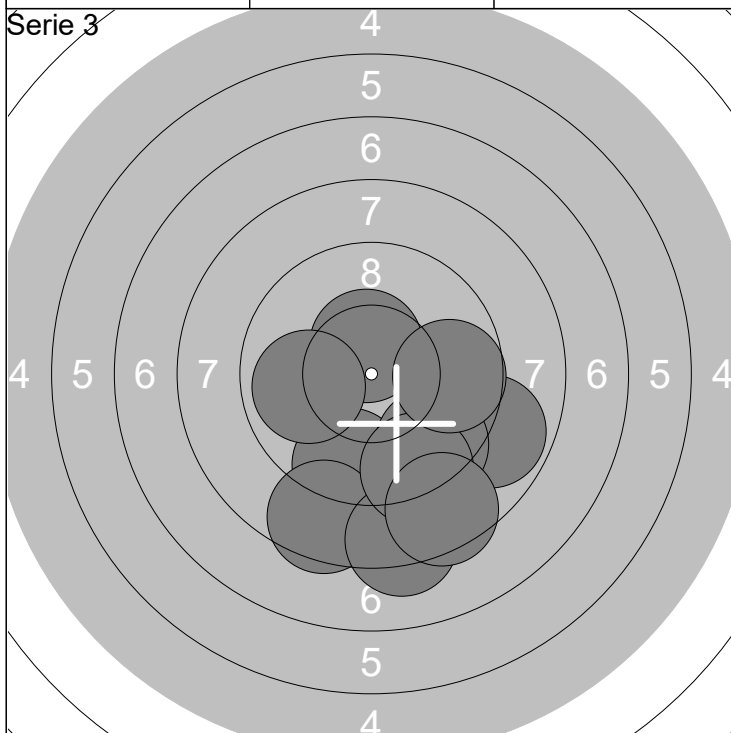

21: 9.5 ↓  
22: 8.6 ↓  
23: 10.5x ↑  
24: 9.9 ←  
25: 8.8 ↘

26: 8.3 ↓  
27: 9.5 ↓  
28: 9.3 ↓  
29: 9.7 →  
30: 8.5 ↓

Serie 92.6

Total 276.6

Serie 4

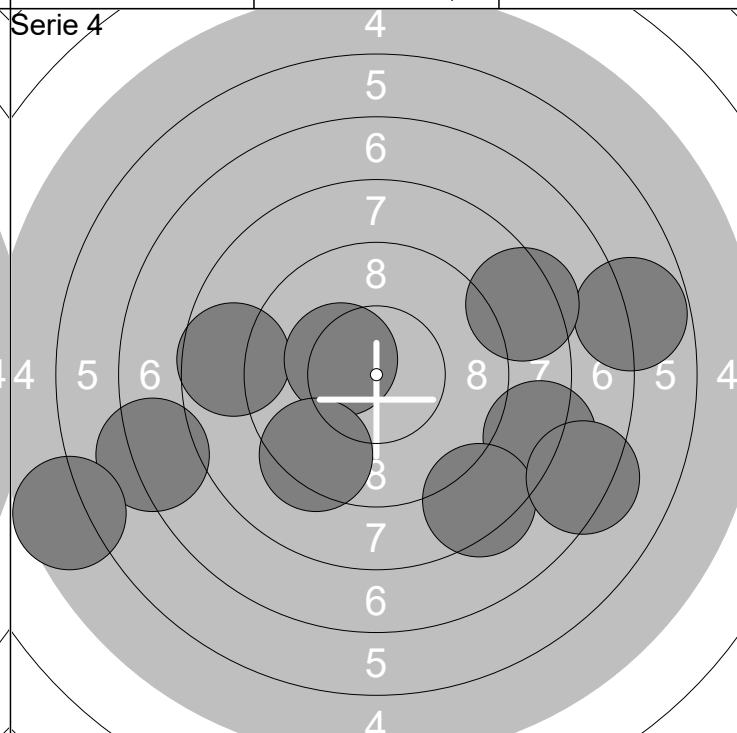

31: 7.2 ←  
32: 8.7 ←  
33: 8.2 →  
34: 10.3x ←  
35: 9.3 ↘

36: 6.8 →  
37: 5.6 ←  
38: 8.4 ↓  
39: 8.4 ↗  
40: 7.3 ↘

Serie 80.2

Total 356.8

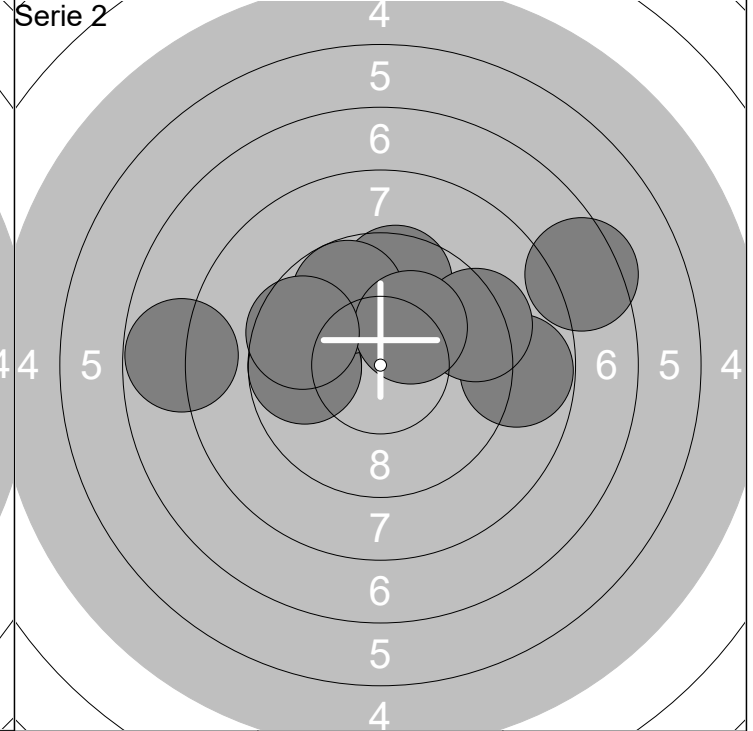
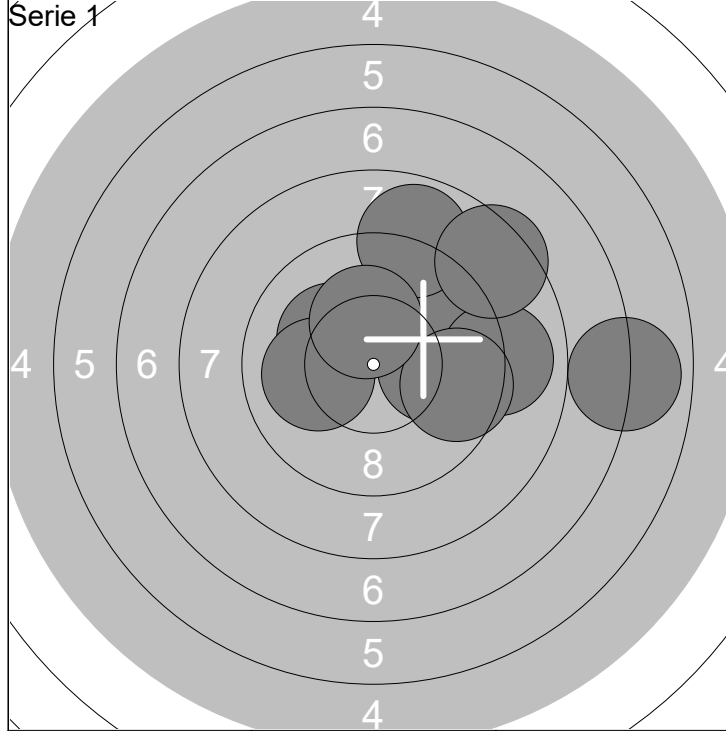

|            |             |               |
|------------|-------------|---------------|
| 1: 10.0 →  | 6: 9.6 →    | Serie<br>92.7 |
| 2: 9.2 ↗   | 7: 8.9 ↑    |               |
| 3: 7.0 →   | 8: 8.4 ↗    |               |
| 4: 10.2x ↖ | 9: 10.1 ←   |               |
| 5: 9.0 →   | 10: 10.3x ↑ |               |
| Total      |             | 92.7          |

|           |             |               |
|-----------|-------------|---------------|
| 11: 7.8 ← | 16: 7.4 ↗   | Serie<br>92.0 |
| 12: 8.8 → | 17: 9.3 ↗   |               |
| 13: 9.8 ← | 18: 9.8 ↑   |               |
| 14: 9.6 ↑ | 19: 10.2x ↗ |               |
| 15: 9.7 ← | 20: 9.6 ←   |               |
| Total     |             | 184.7         |

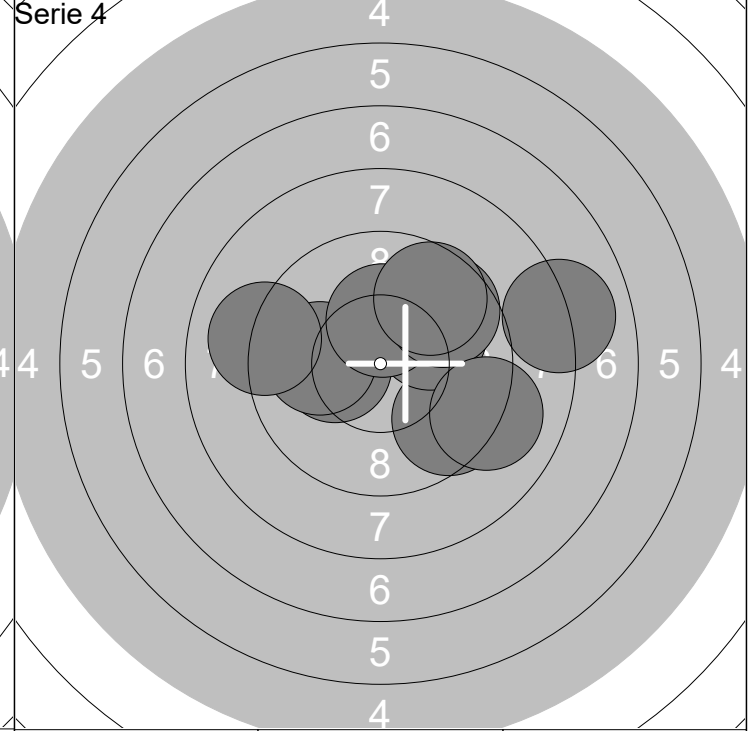
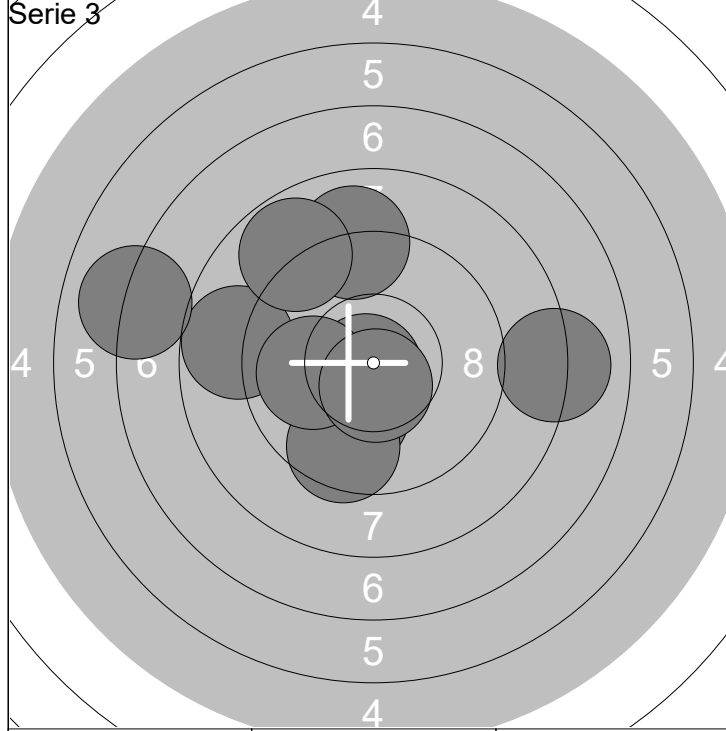

|             |             |               |
|-------------|-------------|---------------|
| 21: 8.8 ←   | 26: 8.8 ↗   | Serie<br>92.8 |
| 22: 10.1 ↓  | 27: 8.1 →   |               |
| 23: 10.8x ↖ | 28: 10.0 ←  |               |
| 24: 9.6 ↓   | 29: 10.6x ↓ |               |
| 25: 9.0 ↑   | 30: 7.0 ←   |               |
| Total       |             | 277.5         |

|             |           |               |
|-------------|-----------|---------------|
| 31: 10.2x ← | 36: 9.1 ← | Serie<br>95.5 |
| 32: 9.6 ↘   | 37: 9.6 ↗ |               |
| 33: 10.0 ←  | 38: 9.1 ↘ |               |
| 34: 10.0 ↗  | 39: 8.0 → |               |
| 35: 10.3x ↑ | 40: 9.6 ↗ |               |
| Total       |           | 373.0         |

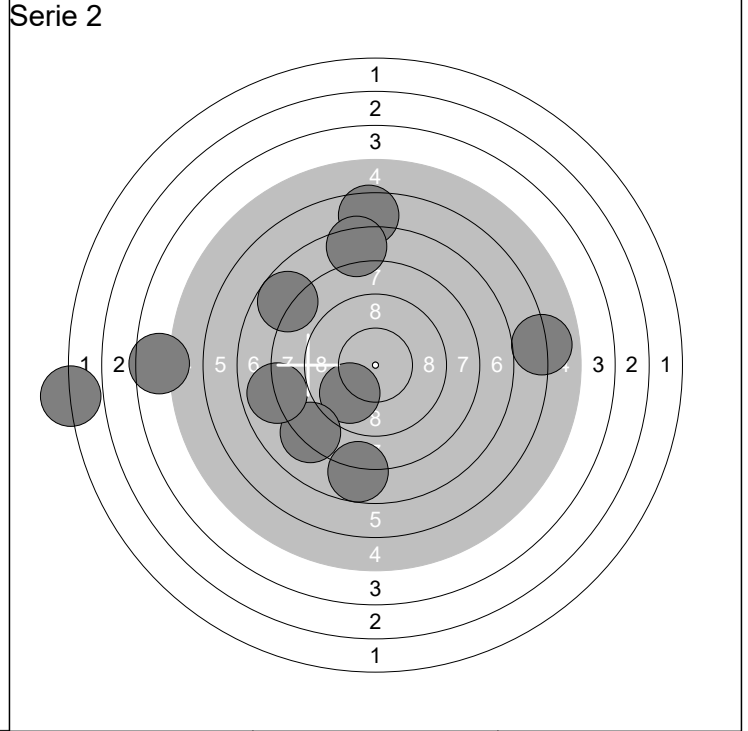
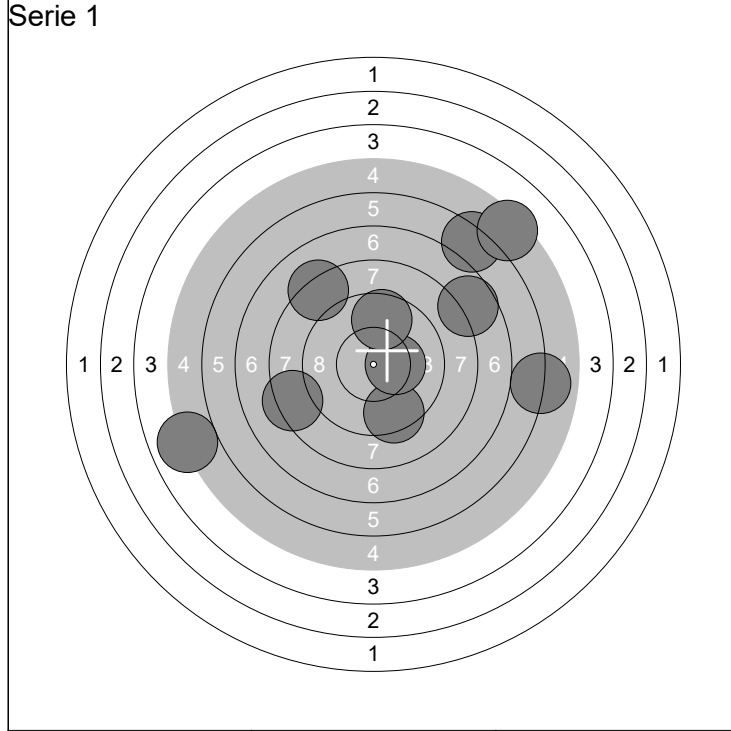

|        |        |        |        |        |        |        |          |        |         |       |      |  |
|--------|--------|--------|--------|--------|--------|--------|----------|--------|---------|-------|------|--|
| 1: 8.3 | 2: 7.6 | 3: 9.4 | 4: 6.0 | 5: 6.3 | 6: 5.3 | 7: 5.0 | 8: 10.3x | 9: 9.6 | 10: 8.2 |       |      |  |
| ←      | ↗      | ↓      | →      | ↗      | ↗      | ←      | →        | ↑      | ↘       | Serie | 76.0 |  |
|        |        |        |        |        |        |        |          |        |         | Total | 76.0 |  |

|         |         |         |         |         |         |         |         |         |         |       |       |  |
|---------|---------|---------|---------|---------|---------|---------|---------|---------|---------|-------|-------|--|
| 11: 9.8 | 12: 7.8 | 13: 4.5 | 14: 6.0 | 15: 8.2 | 16: 7.9 | 17: 6.5 | 18: 1.9 | 19: 7.4 | 20: 7.8 |       |       |  |
| ↙       | ↓       | ←       | →       | ↙       | ←       | ↑       | ←       | ↑       | ↖       | Serie | 67.8  |  |
|         |         |         |         |         |         |         |         |         |         | Total | 143.8 |  |

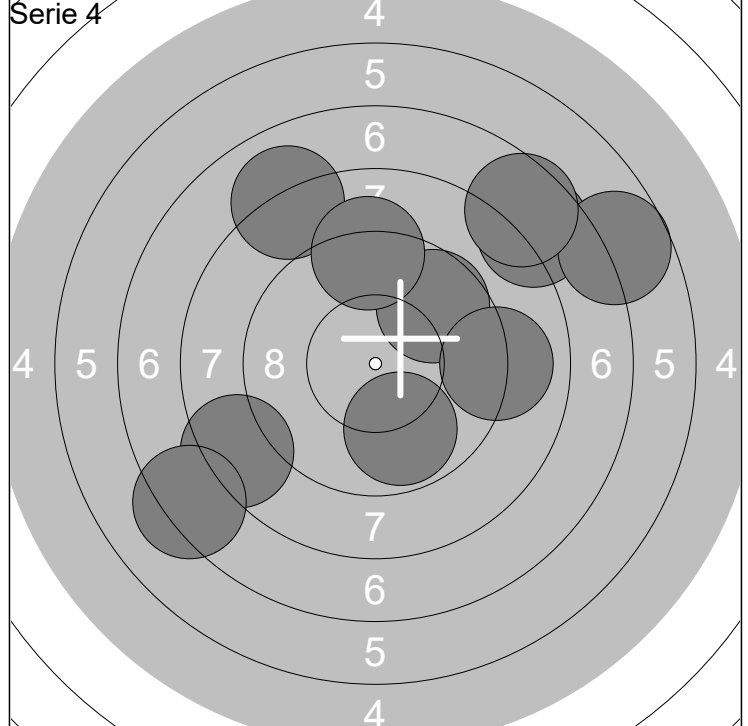
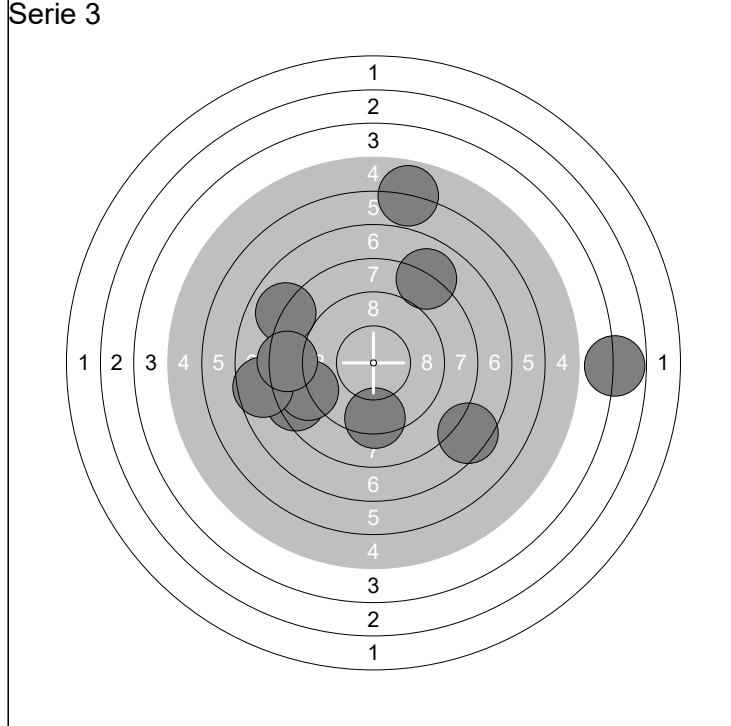

|         |         |         |         |         |         |         |         |         |         |       |       |  |
|---------|---------|---------|---------|---------|---------|---------|---------|---------|---------|-------|-------|--|
| 21: 8.4 | 22: 3.8 | 23: 9.3 | 24: 8.0 | 25: 5.9 | 26: 8.9 | 27: 7.5 | 28: 8.0 | 29: 7.6 | 30: 8.4 |       |       |  |
| ↙       | →       | ↓       | ↖       | ↑       | ←       | ↘       | ↗       | ←       | ←       | Serie | 75.8  |  |
|         |         |         |         |         |         |         |         |         |         | Total | 219.6 |  |

|         |         |         |         |         |         |         |         |         |         |       |       |  |
|---------|---------|---------|---------|---------|---------|---------|---------|---------|---------|-------|-------|--|
| 31: 9.7 | 32: 8.0 | 33: 7.7 | 34: 9.0 | 35: 8.4 | 36: 6.7 | 37: 7.2 | 38: 9.2 | 39: 9.8 | 40: 7.6 |       |       |  |
| ↗       | ↖       | ↗       | →       | ↙       | ↗       | ↙       | ↑       | ↓       | ↗       | Serie | 83.3  |  |
|         |         |         |         |         |         |         |         |         |         | Total | 302.9 |  |

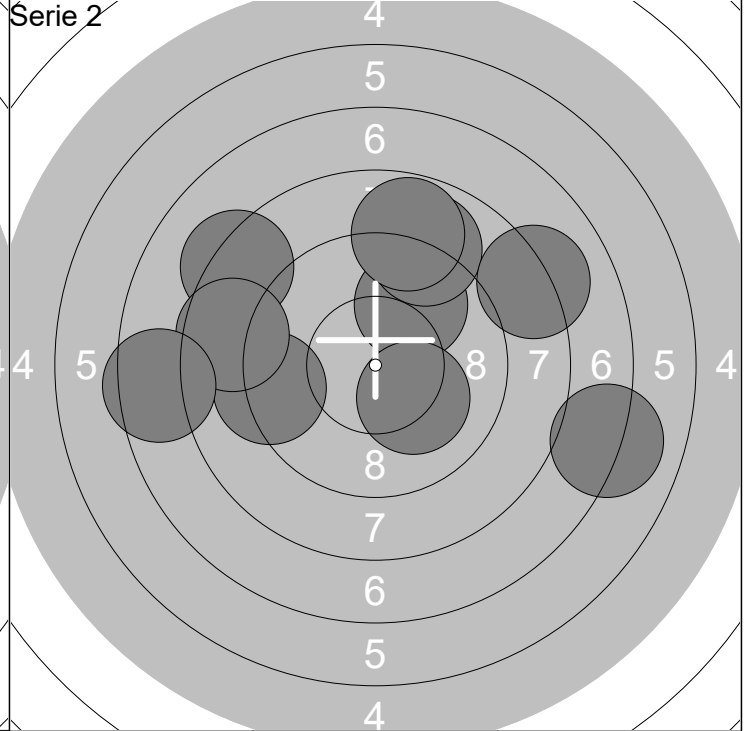
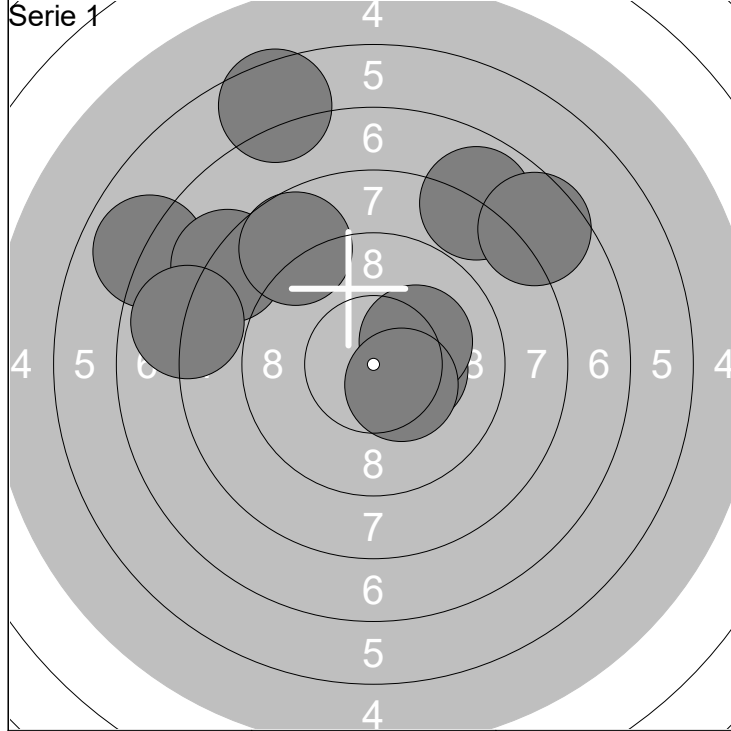

|            |             |               |
|------------|-------------|---------------|
| 1: 7.0 ↖   | 6: 8.8 ↗    | Serie<br>84.7 |
| 2: 10.3x → | 7: 7.9 ↖    |               |
| 3: 6.5 ↗   | 8: 7.6 ↗    | Total<br>84.7 |
| 4: 7.9 ↗   | 9: 10.2x →  |               |
| 5: 8.1 ↖   | 10: 10.4x ↘ |               |

|           |             |                |
|-----------|-------------|----------------|
| 11: 8.3 ↖ | 16: 9.0 ↗   | Serie<br>86.6  |
| 12: 9.2 ↖ | 17: 7.1 →   |                |
| 13: 9.8 ↗ | 18: 10.2x ↘ | Total<br>171.3 |
| 14: 8.6 ↖ | 19: 8.1 ↗   |                |
| 15: 7.5 ↖ | 20: 8.8 ↗   |                |

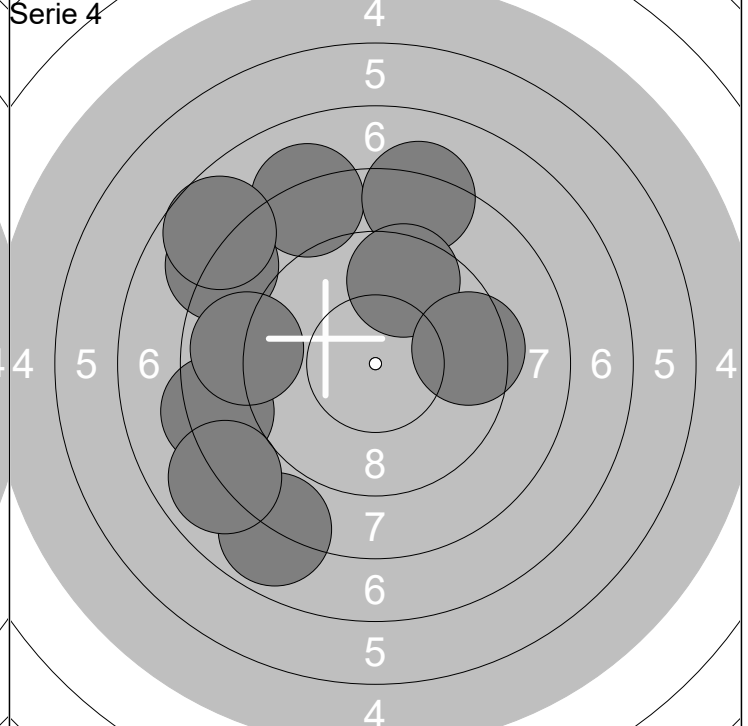
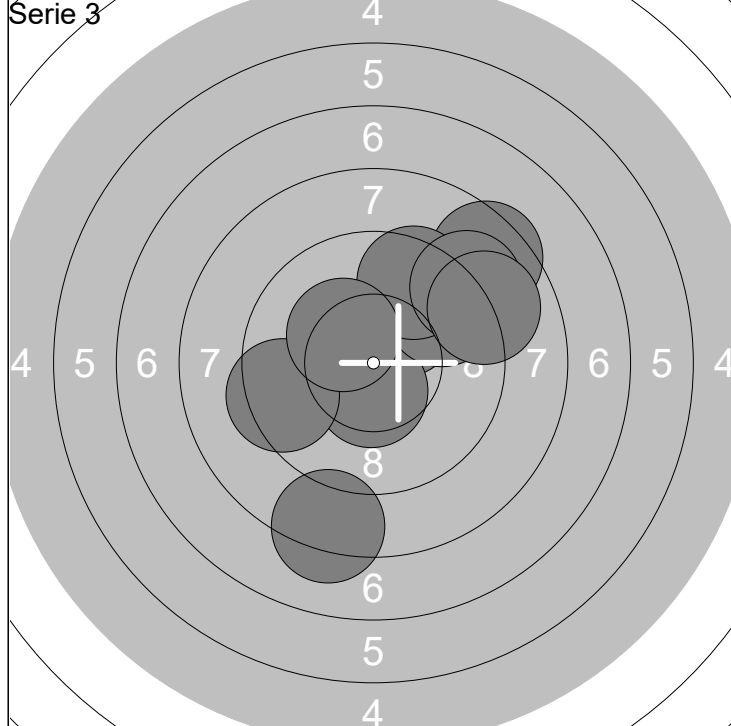

|             |             |                |
|-------------|-------------|----------------|
| 21: 10.1 ↗  | 26: 9.5 ↗   | Serie<br>94.2  |
| 22: 10.5x ↓ | 27: 9.0 ↗   |                |
| 23: 8.5 ↗   | 28: 9.0 →   | Total<br>265.5 |
| 24: 9.6 ↗   | 29: 8.3 ↓   |                |
| 25: 9.4 ↖   | 30: 10.3x ↖ |                |

|           |           |                |
|-----------|-----------|----------------|
| 31: 8.1 ↗ | 36: 8.3 ↖ | Serie<br>84.3  |
| 32: 8.2 ↗ | 37: 7.7 ↖ |                |
| 33: 9.6 ↗ | 38: 8.0 ↖ | Total<br>349.8 |
| 34: 7.9 ↓ | 39: 8.9 ↖ |                |
| 35: 8.1 ↖ | 40: 9.5 → |                |

Skjutlag

Tavla

3

6

Julia Sjögren

Grund

L13s

10.12.2016

Zonfinal Kronobergs län

Söraby SKF

Serie 1

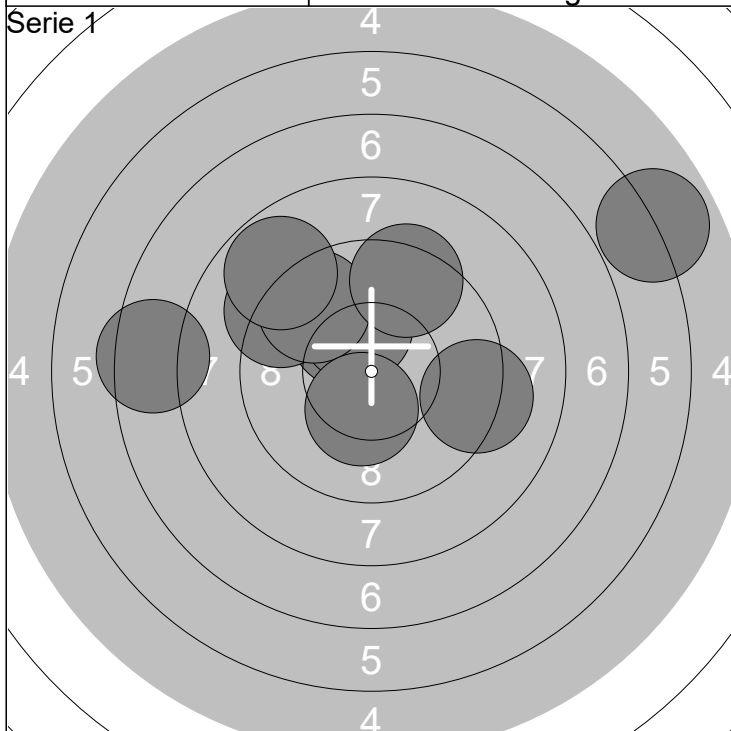

|          |   |           |   |
|----------|---|-----------|---|
| 1: 7.5   | ← | 6: 9.6    | ↗ |
| 2: 5.9   | ↗ | 7: 9.2    | → |
| 3: 10.2x | ↗ | 8: 8.8    | ↗ |
| 4: 10.2x | ↗ | 9: 9.4    | ↗ |
| 5: 9.2   | ↖ | 10: 10.3x | ↓ |

|       |      |
|-------|------|
| Serie | 90.3 |
| Total | 90.3 |

Serie 2

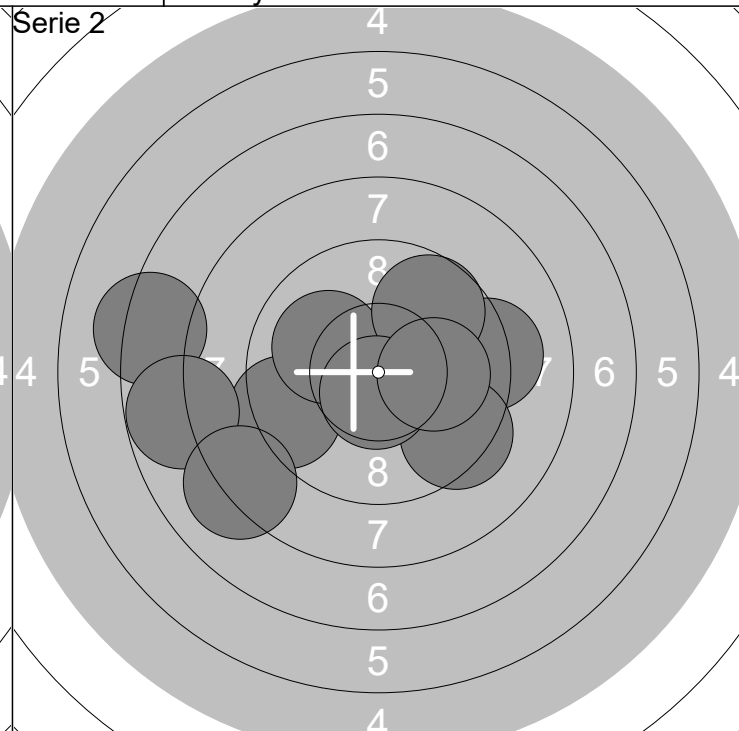

|          |   |           |   |
|----------|---|-----------|---|
| 11: 9.3  | ← | 16: 9.4   | ↘ |
| 12: 7.2  | ← | 17: 9.7   | ↗ |
| 13: 9.2  | → | 18: 10.6x | ↓ |
| 14: 10.0 | ↖ | 19: 10.1  | → |
| 15: 7.8  | ← | 20: 8.1   | ↖ |

|       |       |
|-------|-------|
| Serie | 91.4  |
| Total | 181.7 |

Serie 3

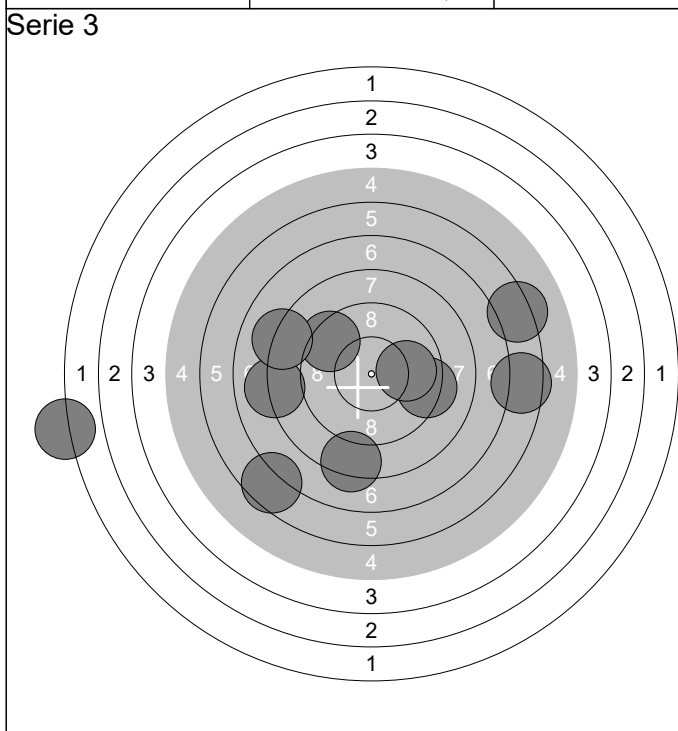

|         |   |         |   |
|---------|---|---------|---|
| 21: 9.3 | → | 26: 1.7 | ← |
| 22: 8.0 | ← | 27: 8.1 | ← |
| 23: 6.5 | → | 28: 6.6 | ↘ |
| 24: 9.4 | ↖ | 29: 8.3 | ↓ |
| 25: 6.3 | ↗ | 30: 9.9 | → |

|       |       |
|-------|-------|
| Serie | 74.1  |
| Total | 255.8 |

Serie 4

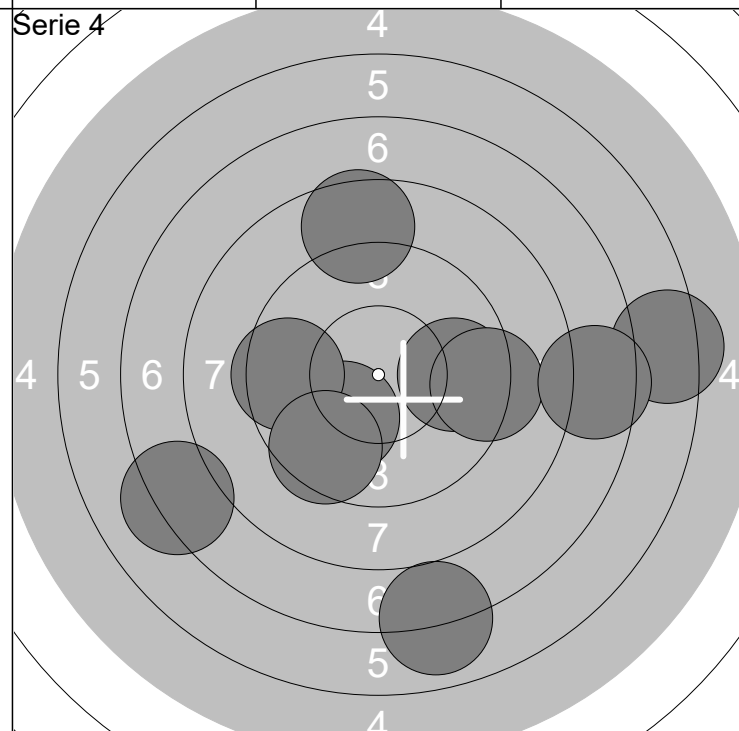

|          |   |         |   |
|----------|---|---------|---|
| 31: 10.1 | ↘ | 36: 9.5 | ↘ |
| 32: 9.5  | ← | 37: 6.3 | → |
| 33: 7.0  | ↓ | 38: 9.2 | → |
| 34: 9.7  | → | 39: 7.5 | → |
| 35: 7.2  | ↖ | 40: 8.6 | ↑ |

|       |       |
|-------|-------|
| Serie | 84.6  |
| Total | 340.4 |

Skjutlag

Tavla

3

7

Thea Lundgren

Grund

L13s

10.12.2016

Zonfinal Kronobergs län

Söraby SKF

Serie 1

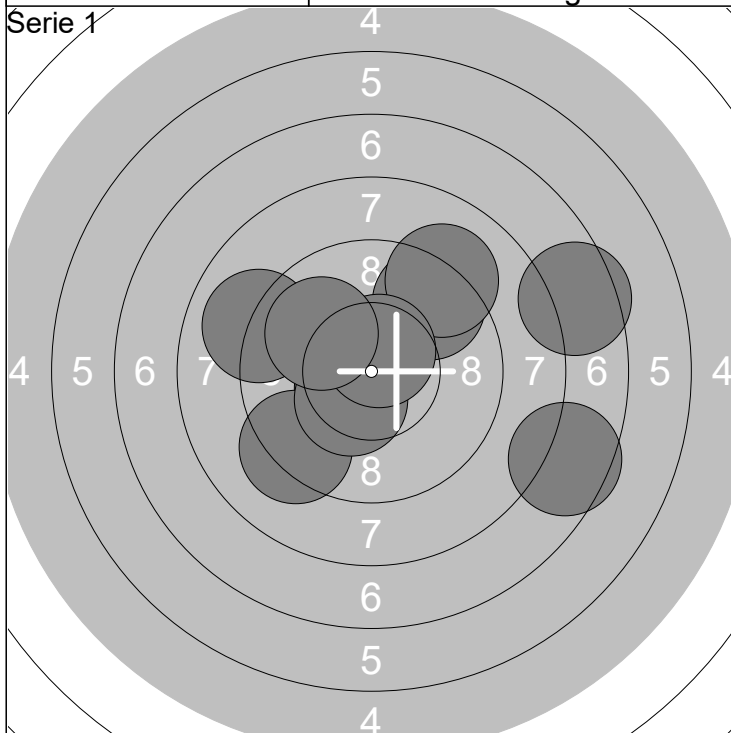

|    |       |   |     |       |   |
|----|-------|---|-----|-------|---|
| 1: | 10.5x | ↙ | 6:  | 9.0   | ← |
| 2: | 9.5   | ↗ | 7:  | 9.1   | ↗ |
| 3: | 9.2   | ↙ | 8:  | 7.6   | ↘ |
| 4: | 7.5   | → | 9:  | 10.6x | ↗ |
| 5: | 10.4x | ↙ | 10: | 10.0  | ↖ |

Serie 93.4

Total 93.4

Serie 2

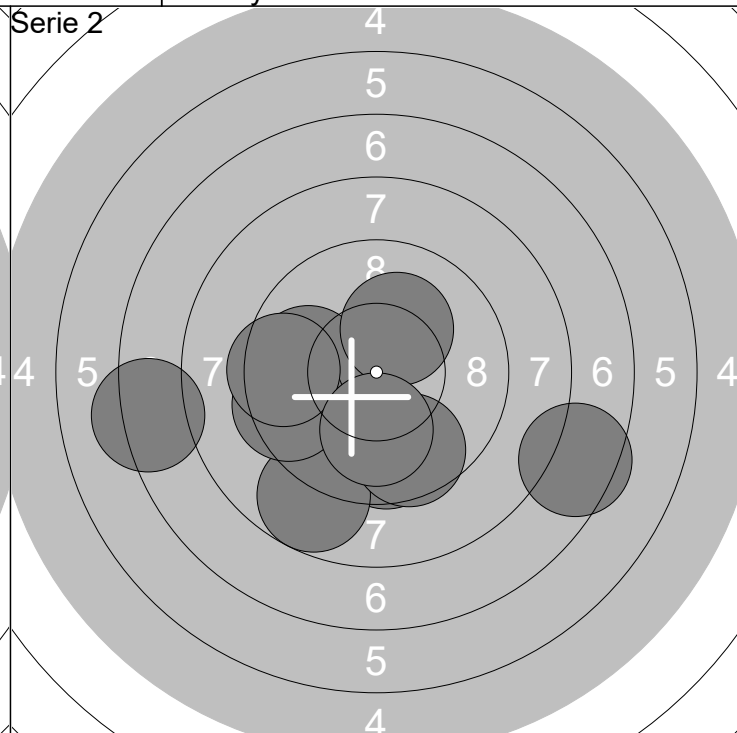

|     |     |   |     |       |   |
|-----|-----|---|-----|-------|---|
| 11: | 9.9 | ← | 16: | 10.2x | ↗ |
| 12: | 9.6 | ↓ | 17: | 9.5   | ← |
| 13: | 7.2 | ← | 18: | 9.6   | ↓ |
| 14: | 8.7 | ↙ | 19: | 7.5   | ↘ |
| 15: | 9.5 | ← | 20: | 10.0  | ↓ |

Serie 91.7

Total 185.1

Serie 3

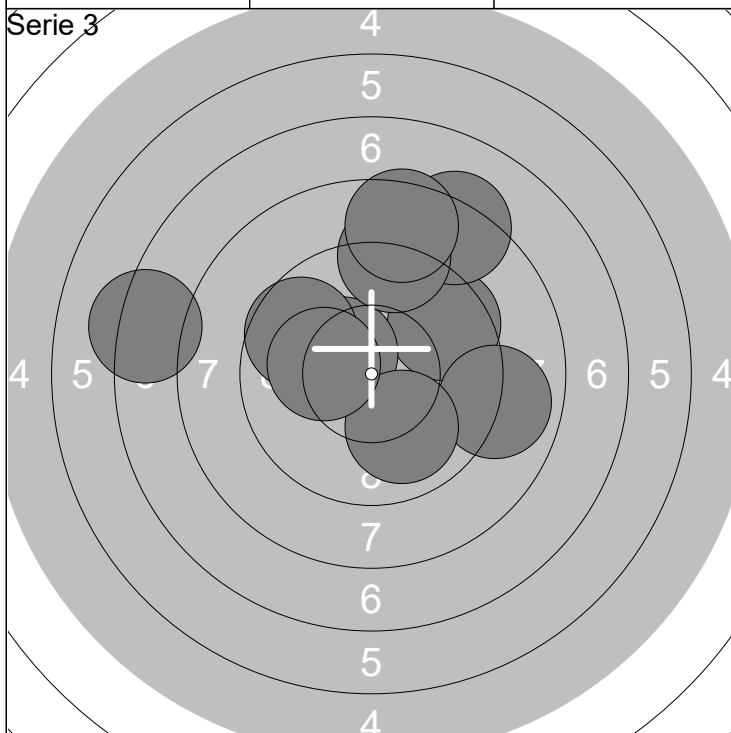

|     |       |   |     |       |   |
|-----|-------|---|-----|-------|---|
| 21: | 9.5   | ↗ | 26: | 10.0  | ↓ |
| 22: | 8.9   | → | 27: | 8.6   | ↑ |
| 23: | 10.4x | ↖ | 28: | 7.3   | ← |
| 24: | 8.3   | ↗ | 29: | 9.7   | ↖ |
| 25: | 9.1   | ↑ | 30: | 10.2x | ← |

Serie 92.0

Total 277.1

Serie 4

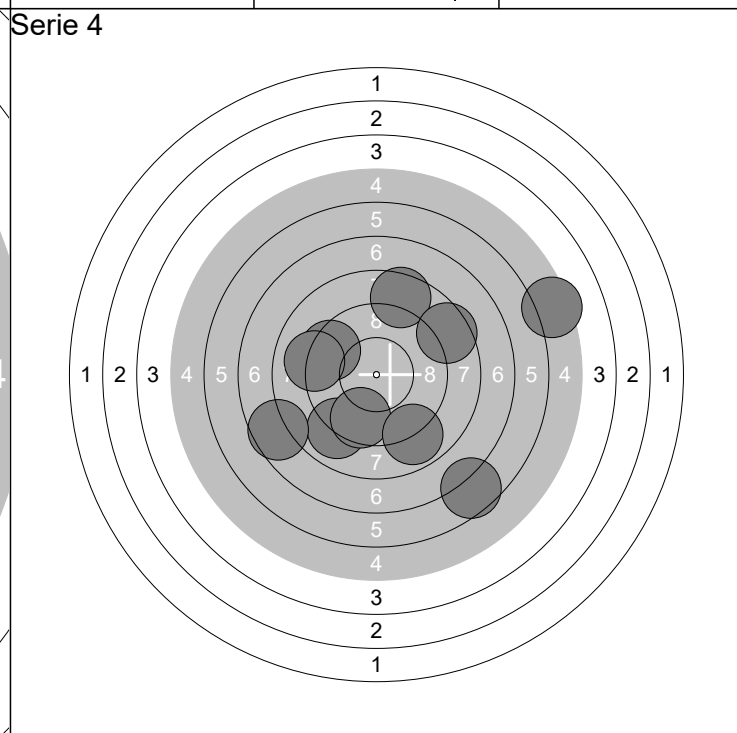

|     |     |   |     |     |   |
|-----|-----|---|-----|-----|---|
| 31: | 5.4 | → | 36: | 8.9 | ↓ |
| 32: | 9.0 | ↙ | 37: | 8.6 | ↑ |
| 33: | 6.6 | ↙ | 38: | 9.1 | ← |
| 34: | 9.4 | ↖ | 39: | 7.6 | ↖ |
| 35: | 9.6 | ↓ | 40: | 8.5 | ↗ |

Serie 82.7

Total 359.8

Serie 1

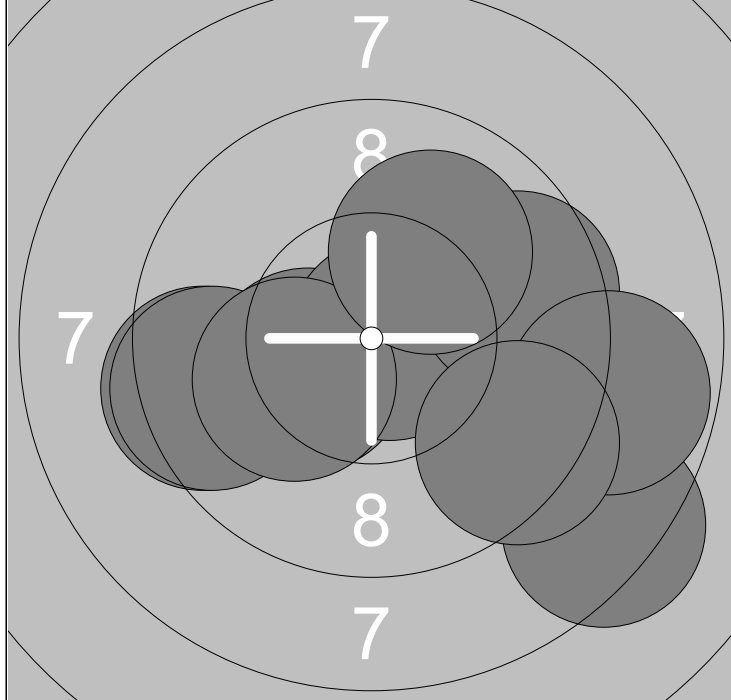

|            |            |       |      |
|------------|------------|-------|------|
| 1: 10.3x ↙ | 6: 10.2x ↙ | Serie | 96.3 |
| 2: 9.4 ↙   | 7: 9.6 →   |       |      |
| 3: 9.5 ↙   | 8: 8.8 →   | Total | 96.3 |
| 4: 10.8x → | 9: 10.0 ↗  |       |      |
| 5: 8.3 ↘   | 10: 9.4 ↘  |       |      |

Serie 2

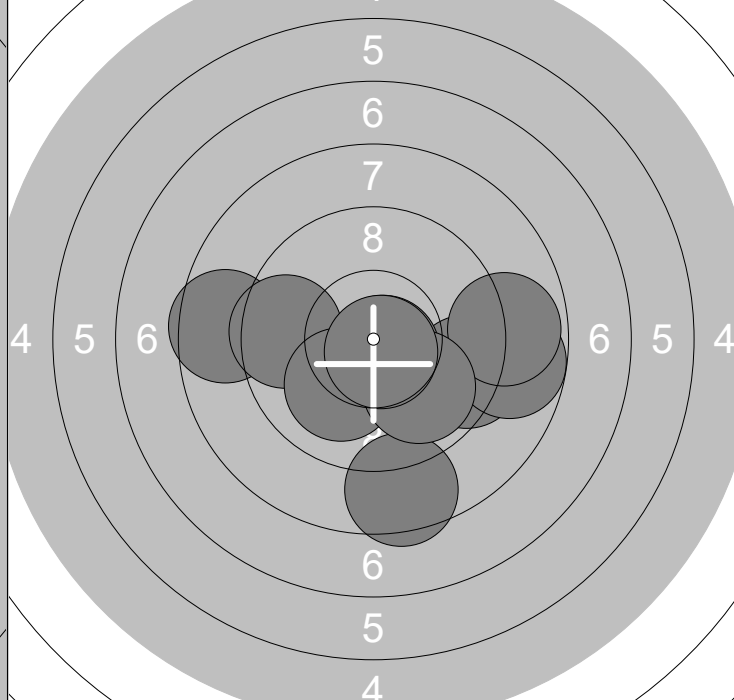

|             |             |       |       |
|-------------|-------------|-------|-------|
| 11: 8.6 ←   | 16: 10.0 ↘  | Serie | 95.0  |
| 12: 9.5 ←   | 17: 8.8 →   |       |       |
| 13: 8.5 ↓   | 18: 8.9 →   | Total | 191.3 |
| 14: 9.4 →   | 19: 9.9 ↘   |       |       |
| 15: 10.7x ↘ | 20: 10.7x ↘ |       |       |

Serie 3

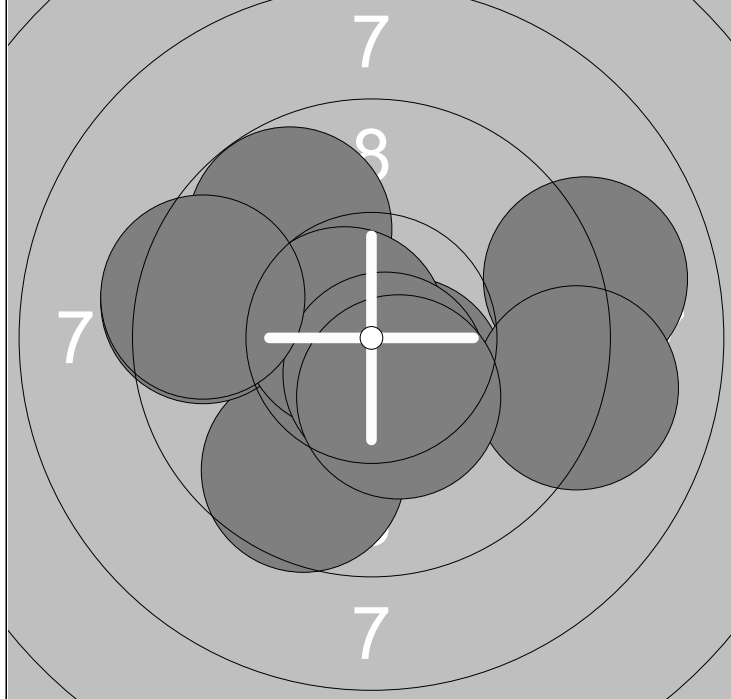

|             |             |       |       |
|-------------|-------------|-------|-------|
| 21: 10.5x ↘ | 26: 9.0 →   | Serie | 98.4  |
| 22: 9.6 ↘   | 27: 10.6x ↘ |       |       |
| 23: 9.7 ↗   | 28: 9.1 →   | Total | 289.7 |
| 24: 9.4 ↙   | 29: 9.4 ↙   |       |       |
| 25: 10.7x ↙ | 30: 10.4x ↘ |       |       |

Serie 4

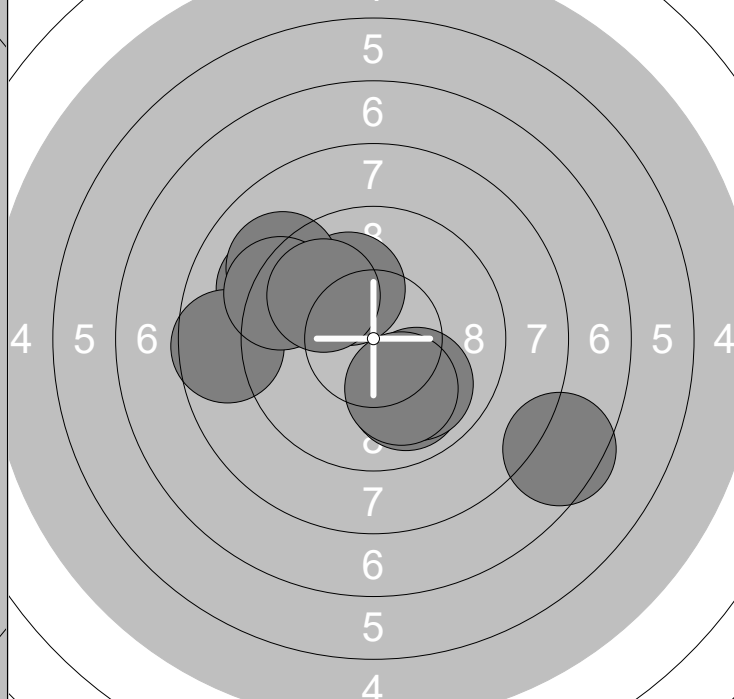

|            |            |       |       |
|------------|------------|-------|-------|
| 31: 9.9 ↘  | 36: 9.1 ↗  | Serie | 93.6  |
| 32: 10.0 ↘ | 37: 7.5 ↘  |       |       |
| 33: 9.2 ↗  | 38: 9.3 ↗  | Total | 383.3 |
| 34: 10.1 ↗ | 39: 9.9 ↗  |       |       |
| 35: 8.6 ←  | 40: 10.0 ↘ |       |       |



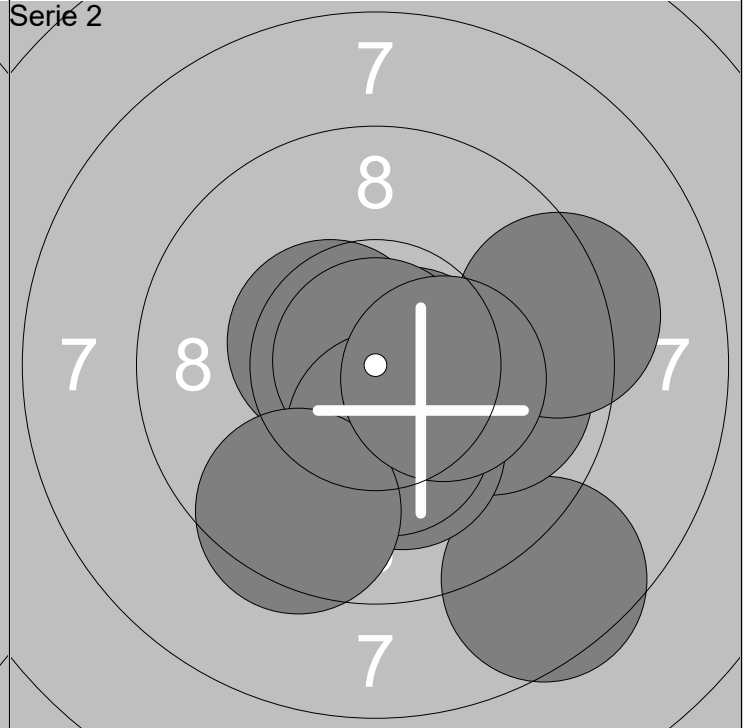
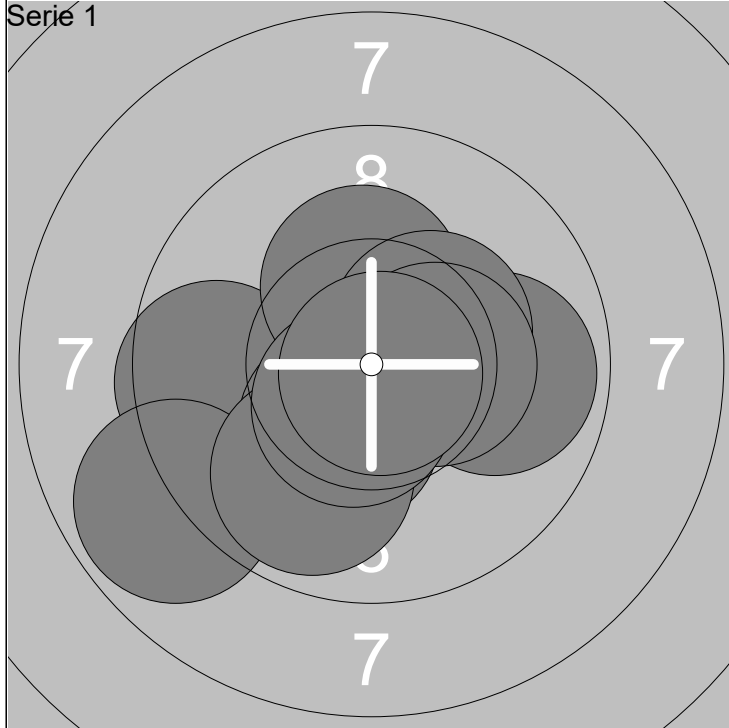

|            |             |       |       |
|------------|-------------|-------|-------|
| 1: 9.6 ←   | 6: 8.8 ↙    | Serie | 100.8 |
| 2: 10.3x ↑ | 7: 9.8 ↘    |       |       |
| 3: 9.9 →   | 8: 10.4x →  | Total | 100.8 |
| 4: 10.4x ↗ | 9: 10.5x ↘  |       |       |
| 5: 10.3x ↘ | 10: 10.8x ↘ |       |       |

|             |             |       |       |
|-------------|-------------|-------|-------|
| 11: 8.5 ↘   | 16: 10.2x ↘ | Serie | 100.0 |
| 12: 10.6x → | 17: 9.3 →   |       |       |
| 13: 10.5x ↖ | 18: 10.3x ↘ | Total | 200.8 |
| 14: 10.9x ↑ | 19: 9.5 ↘   |       |       |
| 15: 9.9 →   | 20: 10.3x → |       |       |

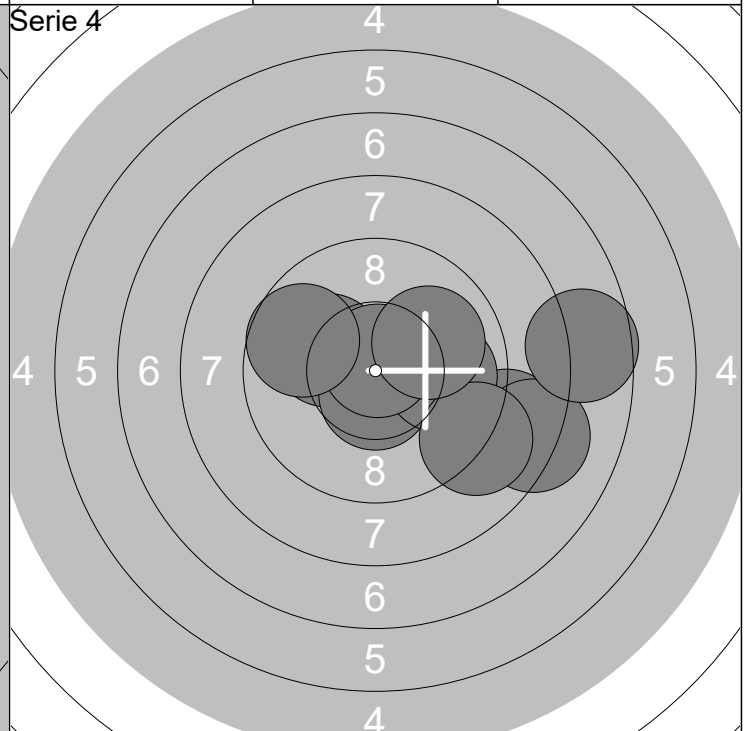
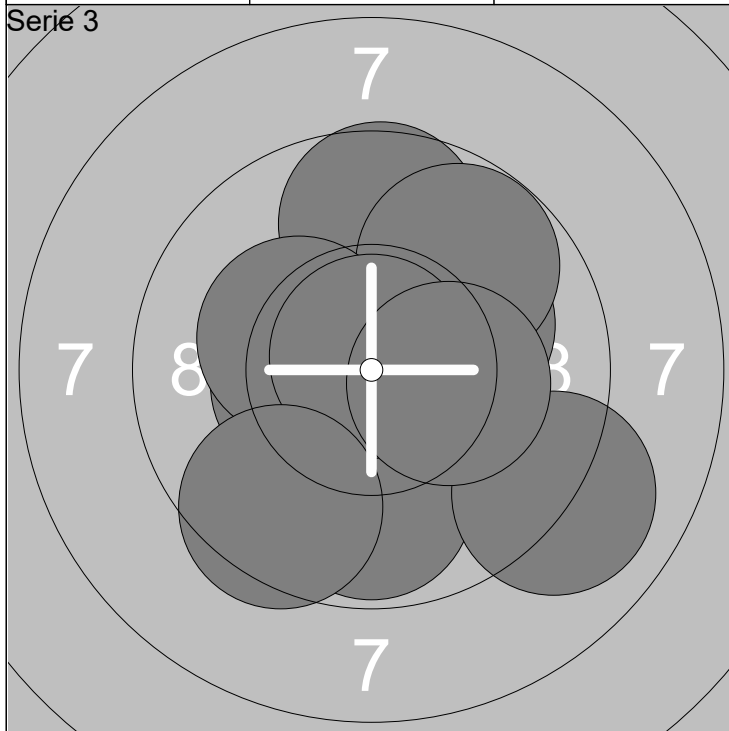

|             |             |       |       |
|-------------|-------------|-------|-------|
| 21: 10.1 ↗  | 26: 9.8 ↓   | Serie | 99.5  |
| 22: 10.4x ← | 27: 10.8x ↑ |       |       |
| 23: 9.7 ↑   | 28: 9.0 ↘   | Total | 300.3 |
| 24: 9.8 ↗   | 29: 9.5 ↘   |       |       |
| 25: 10.2x ↖ | 30: 10.2x → |       |       |

|             |             |       |       |
|-------------|-------------|-------|-------|
| 31: 10.1 ↖  | 36: 9.0 ↘   | Serie | 94.7  |
| 32: 8.7 →   | 37: 10.8x ↑ |       |       |
| 33: 8.2 →   | 38: 9.7 ↖   | Total | 395.0 |
| 34: 10.6x ↓ | 39: 10.0 ↗  |       |       |
| 35: 9.9 →   | 40: 7.7 →   |       |       |

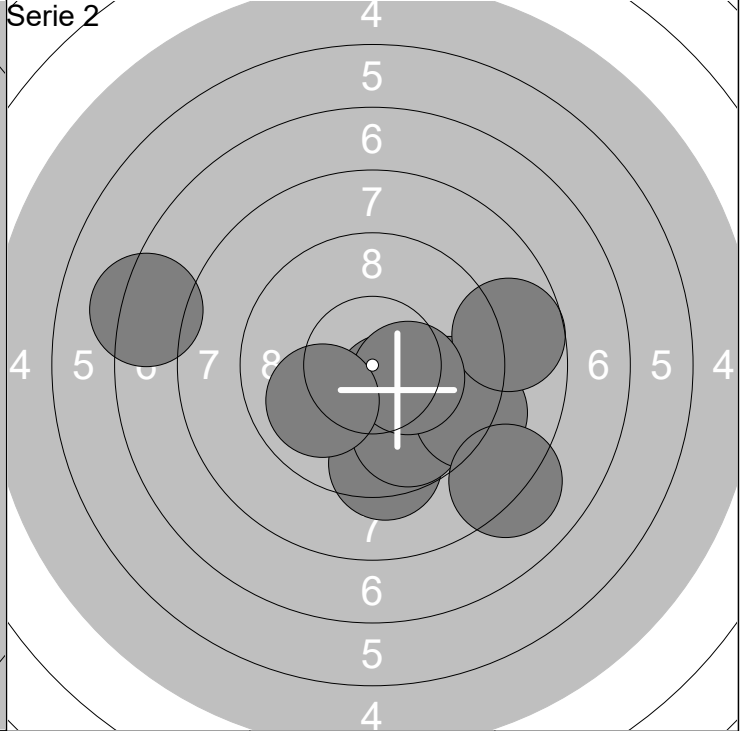
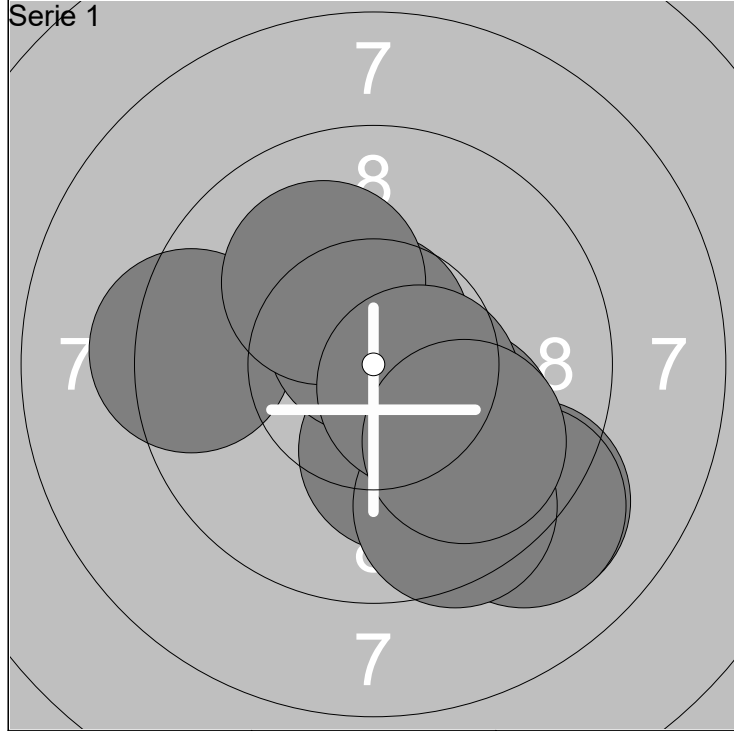

|            |            |       |      |
|------------|------------|-------|------|
| 1: 10.2x ↓ | 6: 9.1 ↓   | Serie | 98.5 |
| 2: 9.3 ←   | 7: 10.1 ↗  |       |      |
| 3: 10.7x ↑ | 8: 9.5 ↓   | Total | 98.5 |
| 4: 10.0 ↓  | 9: 10.5x ↓ |       |      |
| 5: 9.2 ↓   | 10: 9.9 ↓  |       |      |

|             |             |       |       |
|-------------|-------------|-------|-------|
| 11: 7.2 ←   | 16: 9.2 ↘   | Serie | 93.0  |
| 12: 9.7 ↘   | 17: 8.7 →   |       |       |
| 13: 9.4 ↓   | 18: 10.4x ↘ | Total | 191.5 |
| 14: 10.4x ↓ | 19: 10.0 ←  |       |       |
| 15: 9.8 ↓   | 20: 8.2 ↓   |       |       |

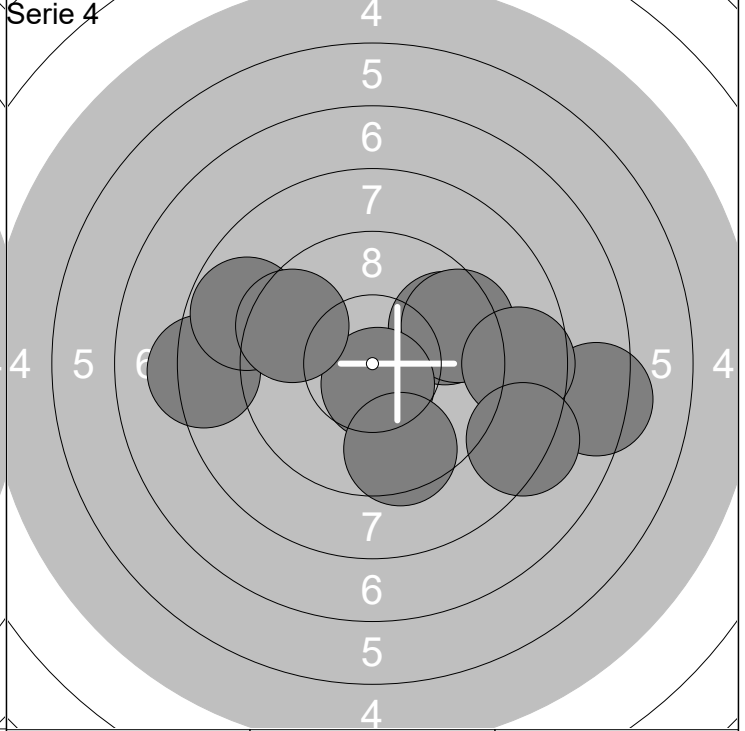
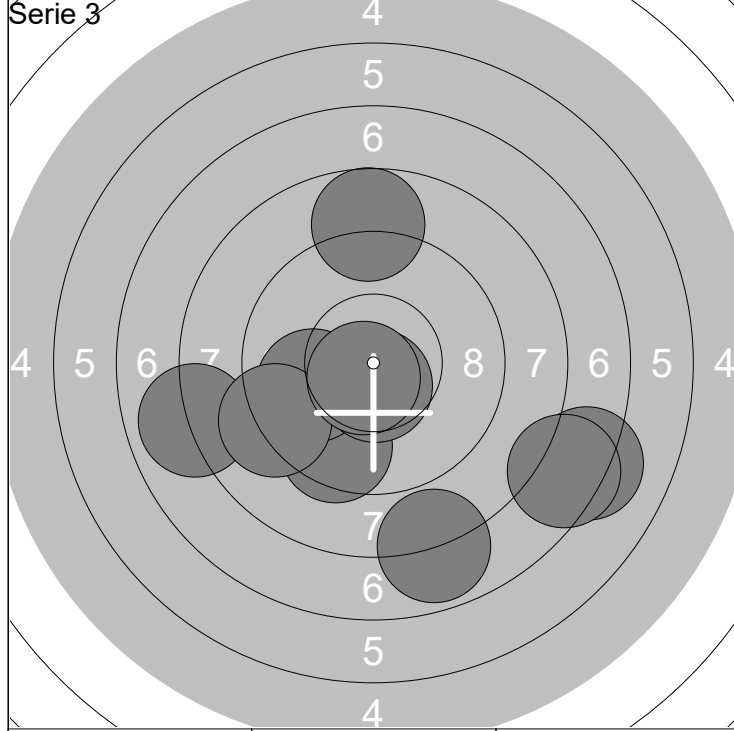

|           |             |       |       |
|-----------|-------------|-------|-------|
| 21: 7.2 → | 26: 7.4 ↘   | Serie | 89.0  |
| 22: 9.5 ↓ | 27: 7.9 ↓   |       |       |
| 23: 8.0 ← | 28: 10.6x ↓ | Total | 280.5 |
| 24: 9.9 ← | 29: 10.7x ↓ |       |       |
| 25: 9.1 ← | 30: 8.7 ↑   |       |       |

|           |             |       |       |
|-----------|-------------|-------|-------|
| 31: 9.7 ↗ | 36: 10.6x ↓ | Serie | 90.2  |
| 32: 8.3 ← | 37: 8.6 →   |       |       |
| 33: 7.4 → | 38: 8.2 ↘   | Total | 370.7 |
| 34: 9.5 ↗ | 39: 9.6 ←   |       |       |
| 35: 8.8 ← | 40: 9.5 ↓   |       |       |

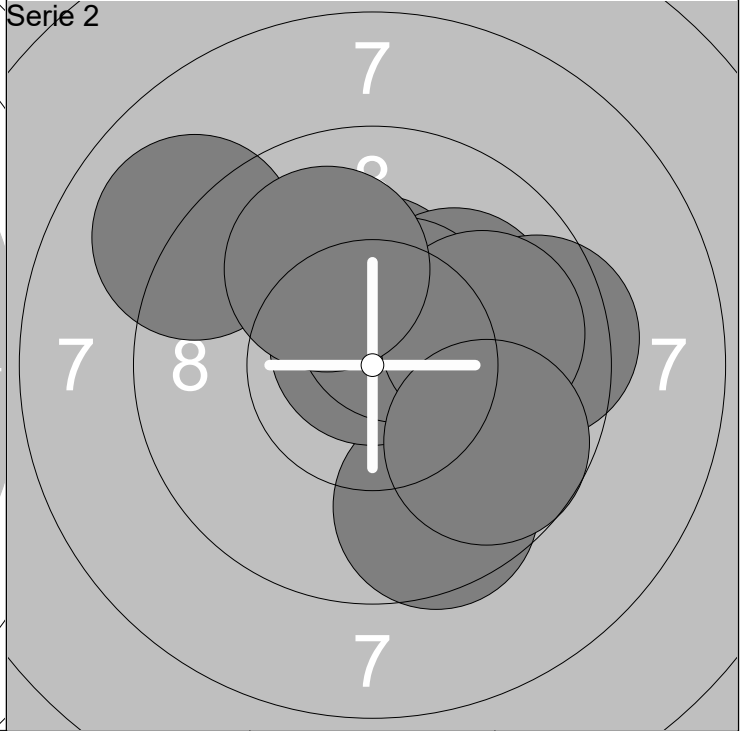
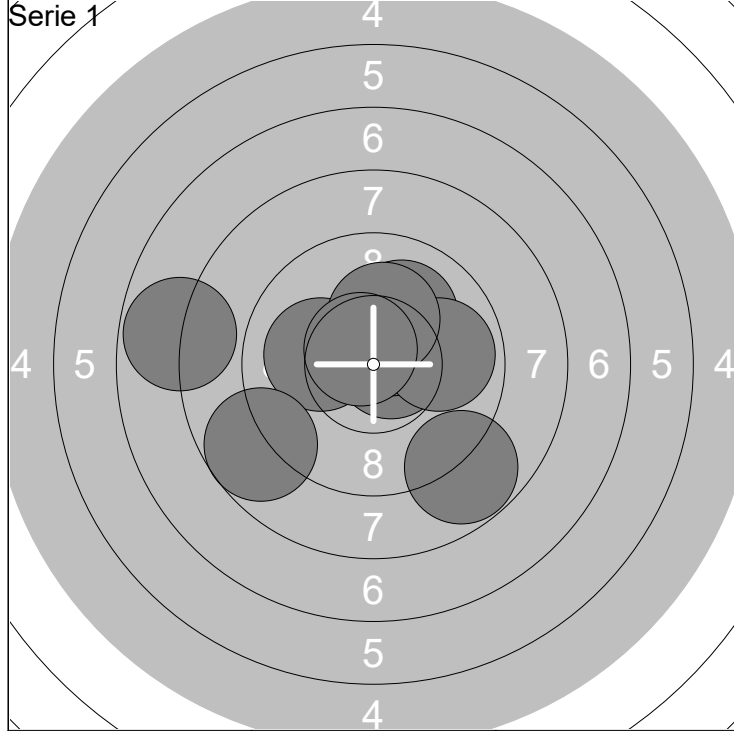

|            |            |       |      |
|------------|------------|-------|------|
| 1: 7.8 ←   | 6: 9.9 →   | Serie | 97.4 |
| 2: 10.1 ←  | 7: 8.7 ↙   |       |      |
| 3: 10.7x → | 8: 10.2x ↑ | Total | 97.4 |
| 4: 10.5x ↗ | 9: 10.6x ↘ |       |      |
| 5: 10.1 ↗  | 10: 8.8 ↘  |       |      |

|             |             |       |       |
|-------------|-------------|-------|-------|
| 11: 10.3x ↑ | 16: 9.0 ↙   | Serie | 99.5  |
| 12: 9.6 ↘   | 17: 10.5x ↗ |       |       |
| 13: 10.1 ↗  | 18: 9.9 →   | Total | 196.9 |
| 14: 9.5 →   | 19: 10.0 ↑  |       |       |
| 15: 10.8x ↑ | 20: 9.8 ↘   |       |       |

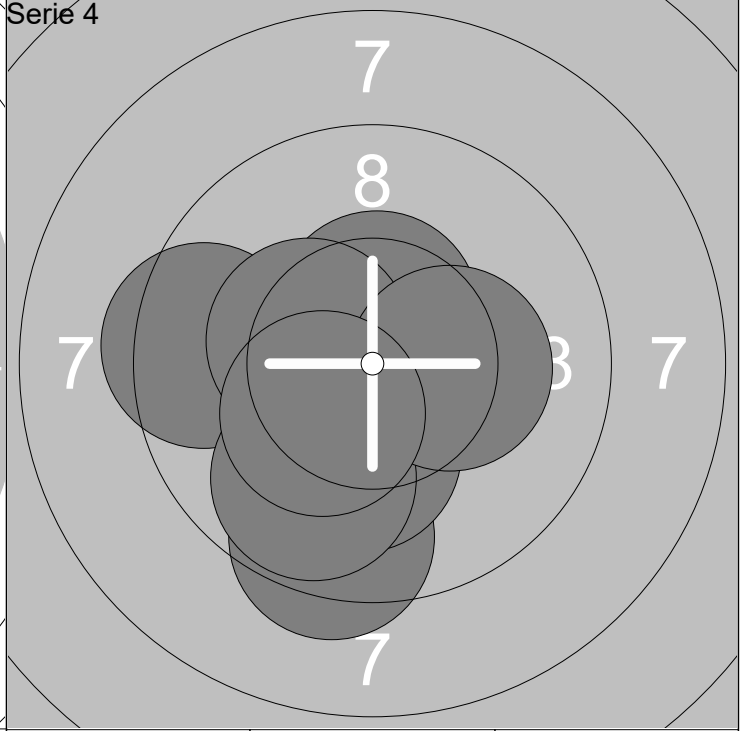
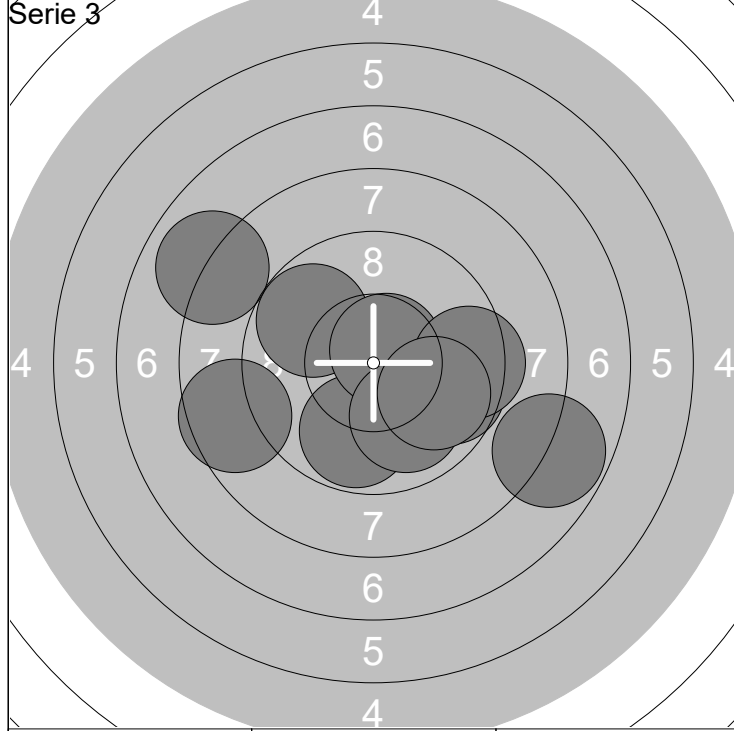

|             |            |       |       |
|-------------|------------|-------|-------|
| 21: 9.8 ↙   | 26: 7.8 ↘  | Serie | 93.7  |
| 22: 9.7 →   | 27: 9.4 →  |       |       |
| 23: 9.8 ↘   | 28: 10.0 ↘ | Total | 290.6 |
| 24: 8.0 ↙   | 29: 9.9 ↘  |       |       |
| 25: 10.7x ↗ | 30: 8.6 ←  |       |       |

|             |             |       |       |
|-------------|-------------|-------|-------|
| 31: 10.6x → | 36: 10.2x ↘ | Serie | 101.7 |
| 32: 9.5 ←   | 37: 9.8 ↘   |       |       |
| 33: 9.4 ↘   | 38: 10.4x ← | Total | 392.3 |
| 34: 10.5x ↑ | 39: 10.3x → |       |       |
| 35: 10.7x ↘ | 40: 10.3x ↙ |       |       |

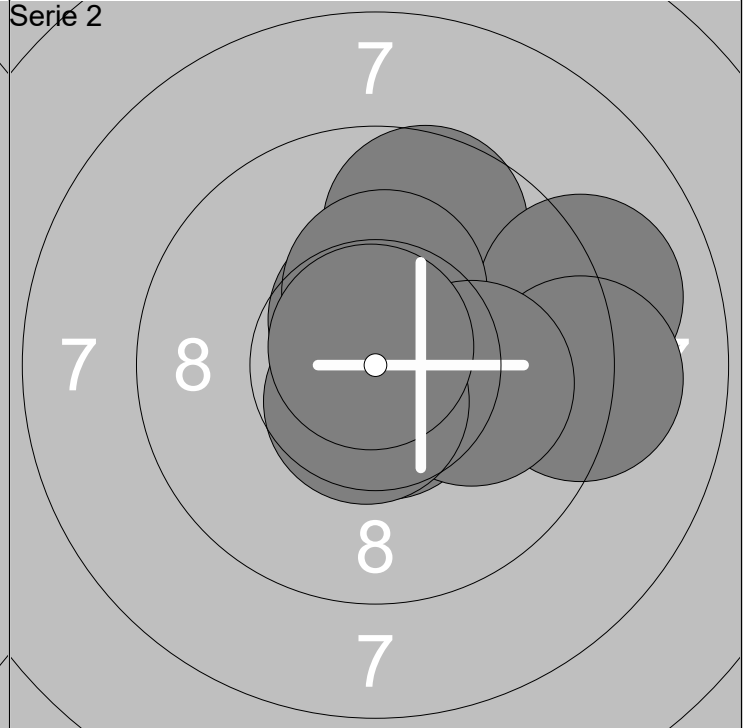
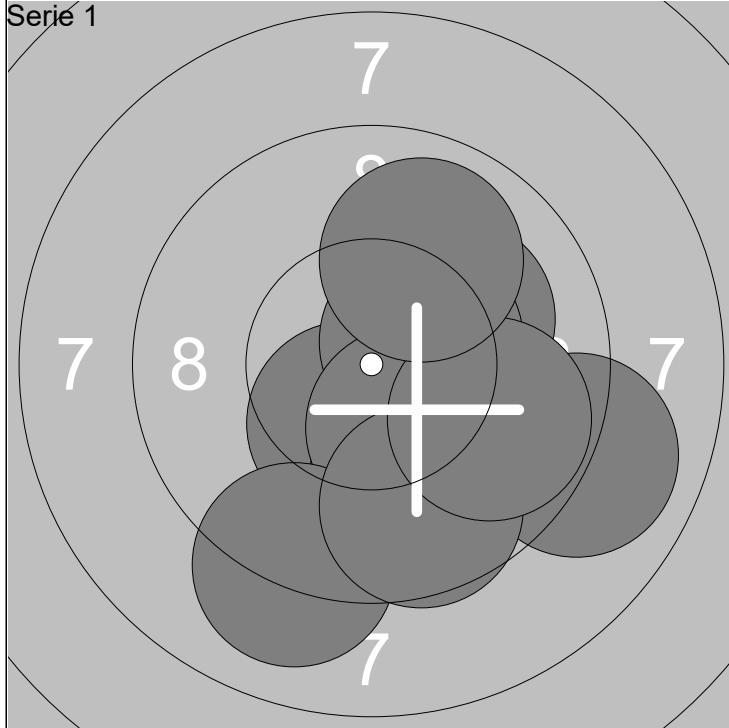

|            |            |       |      |
|------------|------------|-------|------|
| 1: 10.4x ↘ | 6: 10.3x ↘ | Serie | 98.5 |
| 2: 9.0 →   | 7: 9.0 ↘   |       |      |
| 3: 10.1 ↗  | 8: 9.6 ↘   | Total | 98.5 |
| 4: 10.5x ↗ | 9: 9.8 →   |       |      |
| 5: 9.9 ↘   | 10: 9.9 ↗  |       |      |

|             |             |       |       |
|-------------|-------------|-------|-------|
| 11: 9.7 ↗   | 16: 10.3x ↗ | Serie | 101.1 |
| 12: 10.5x ↗ | 17: 9.1 →   |       |       |
| 13: 10.2x → | 18: 10.1 →  | Total | 199.6 |
| 14: 10.7x ↘ | 19: 10.6x ↘ |       |       |
| 15: 9.1 →   | 20: 10.8x ↗ |       |       |

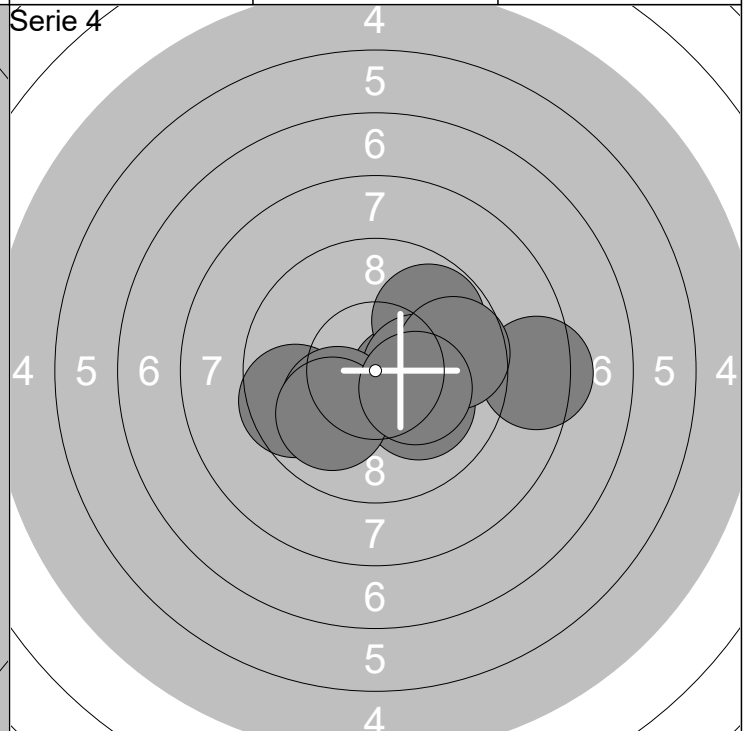
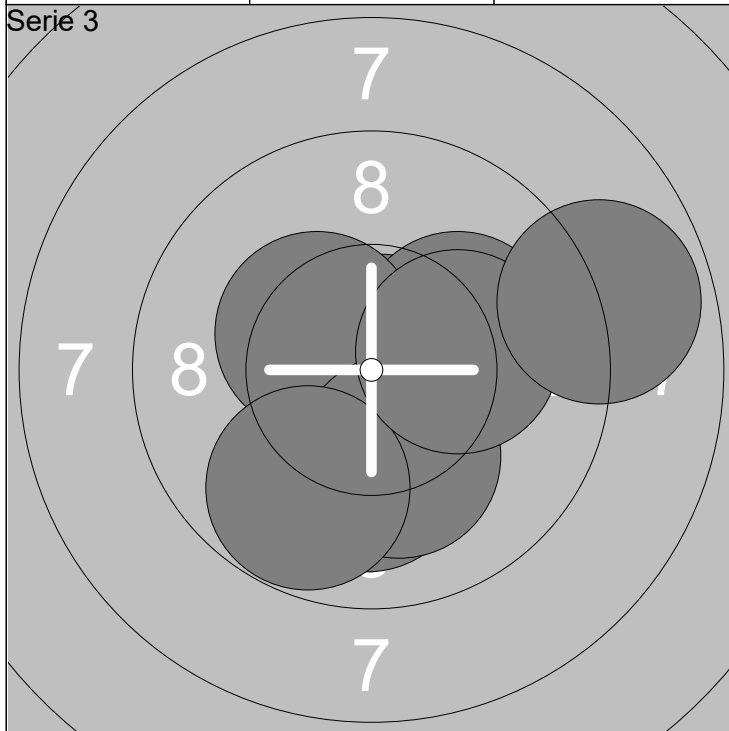

|             |             |       |       |
|-------------|-------------|-------|-------|
| 21: 10.1 ↘  | 26: 10.4x ↖ | Serie | 101.3 |
| 22: 10.8x ↗ | 27: 10.2x ↘ |       |       |
| 23: 10.4x ↘ | 28: 9.7 ↘   | Total | 300.9 |
| 24: 10.1 ↗  | 29: 10.2x → |       |       |
| 25: 10.5x ↘ | 30: 8.9 →   |       |       |

|             |             |       |       |
|-------------|-------------|-------|-------|
| 31: 10.1 ↘  | 36: 10.3x → | Serie | 98.8  |
| 32: 9.6 ←   | 37: 9.7 →   |       |       |
| 33: 8.4 →   | 38: 10.1 ↘  | Total | 399.7 |
| 34: 10.5x → | 39: 10.0 ↘  |       |       |
| 35: 9.8 ↗   | 40: 10.3x ↘ |       |       |

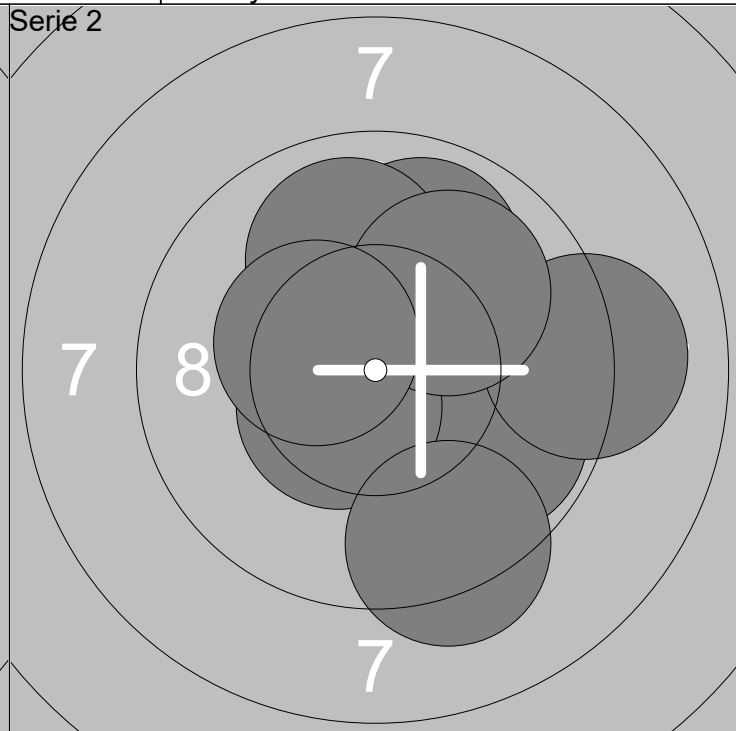
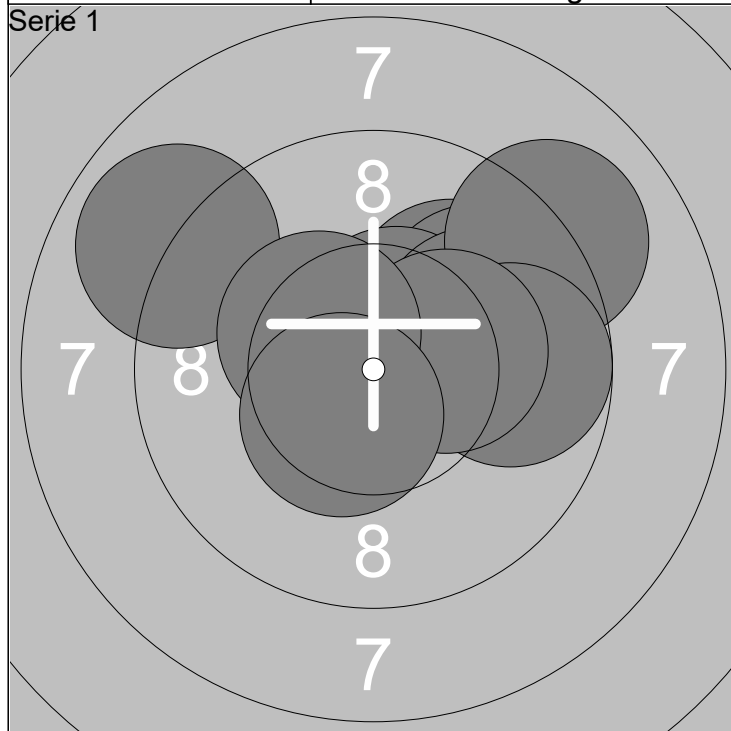

|            |             |       |      |
|------------|-------------|-------|------|
| 1: 10.1 ↗  | 6: 9.1 ↗    | Serie | 99.6 |
| 2: 9.9 ↗   | 7: 9.8 →    |       |      |
| 3: 8.9 ↖   | 8: 10.3x →  | Total | 99.6 |
| 4: 10.6x ↗ | 9: 10.4x ↖  |       |      |
| 5: 10.0 →  | 10: 10.5x ↘ |       |      |

|             |             |       |       |
|-------------|-------------|-------|-------|
| 11: 10.0 →  | 16: 10.5x ↘ | Serie | 99.3  |
| 12: 10.3x ↗ | 17: 10.0 ↗  |       |       |
| 13: 9.9 ↗   | 18: 10.0 ↗  | Total | 198.9 |
| 14: 9.8 ↘   | 19: 10.4x ↖ |       |       |
| 15: 9.1 →   | 20: 9.3 ↘   |       |       |

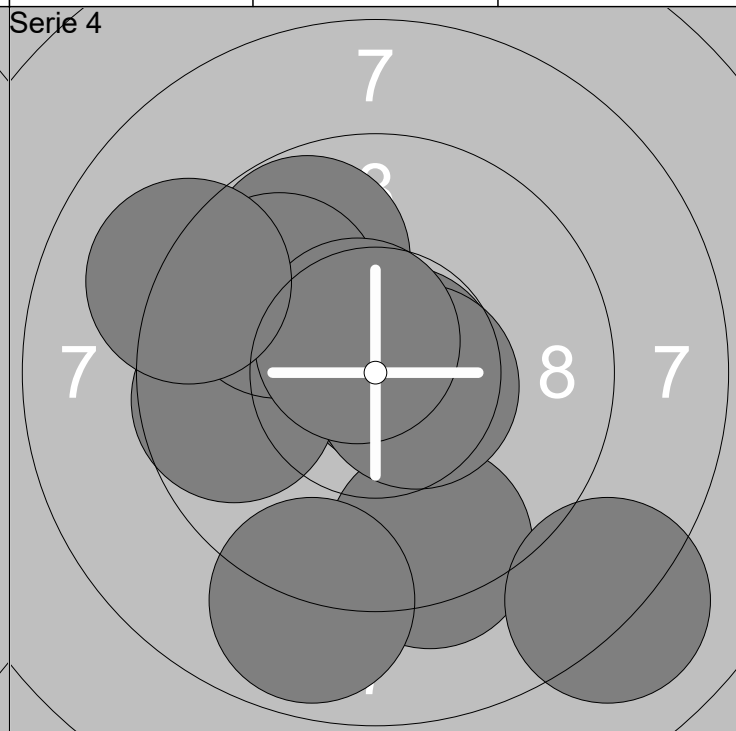
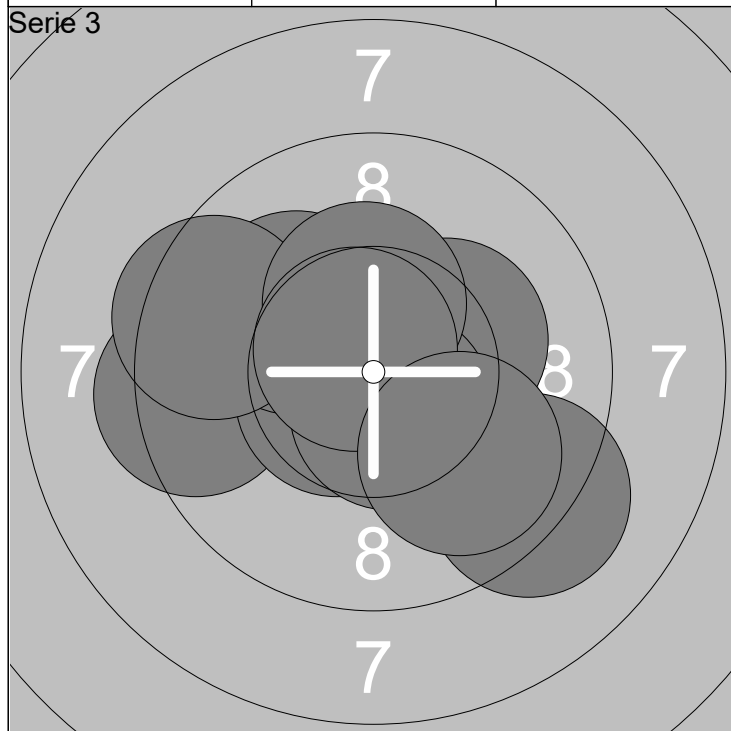

|             |             |       |       |
|-------------|-------------|-------|-------|
| 21: 9.4 ←   | 26: 9.2 ↘   | Serie | 100.7 |
| 22: 10.6x ↖ | 27: 9.5 ↖   |       |       |
| 23: 10.1 ↖  | 28: 10.4x ↗ | Total | 299.6 |
| 24: 10.3x ↗ | 29: 10.7x ↗ |       |       |
| 25: 10.6x ↘ | 30: 9.9 ↘   |       |       |

|             |             |       |       |
|-------------|-------------|-------|-------|
| 31: 9.8 ↗   | 36: 9.9 ↖   | Serie | 96.7  |
| 32: 10.7x → | 37: 10.6x ↗ |       |       |
| 33: 9.3 ↘   | 38: 8.1 ↘   | Total | 396.3 |
| 34: 9.7 ←   | 39: 8.9 ↘   |       |       |
| 35: 10.6x → | 40: 9.1 ↖   |       |       |

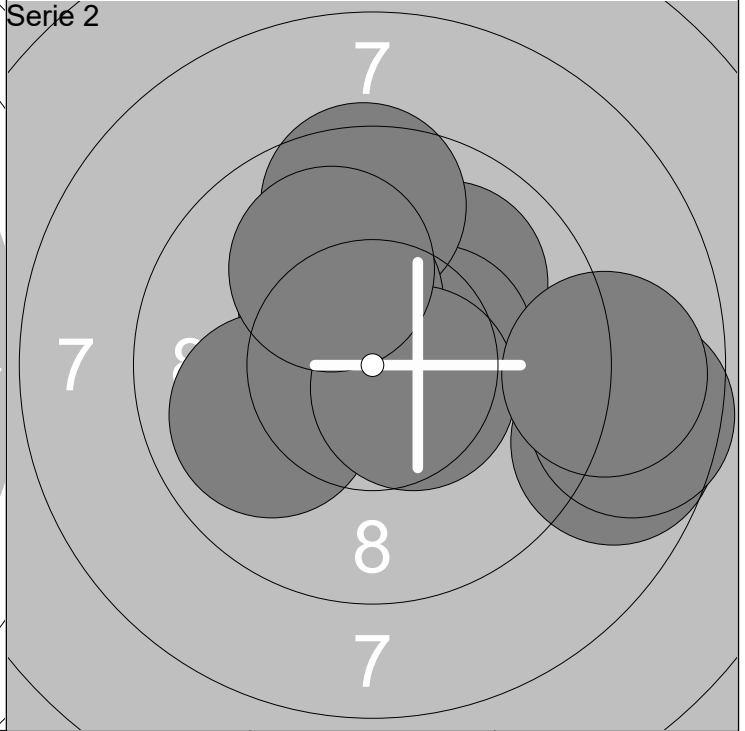
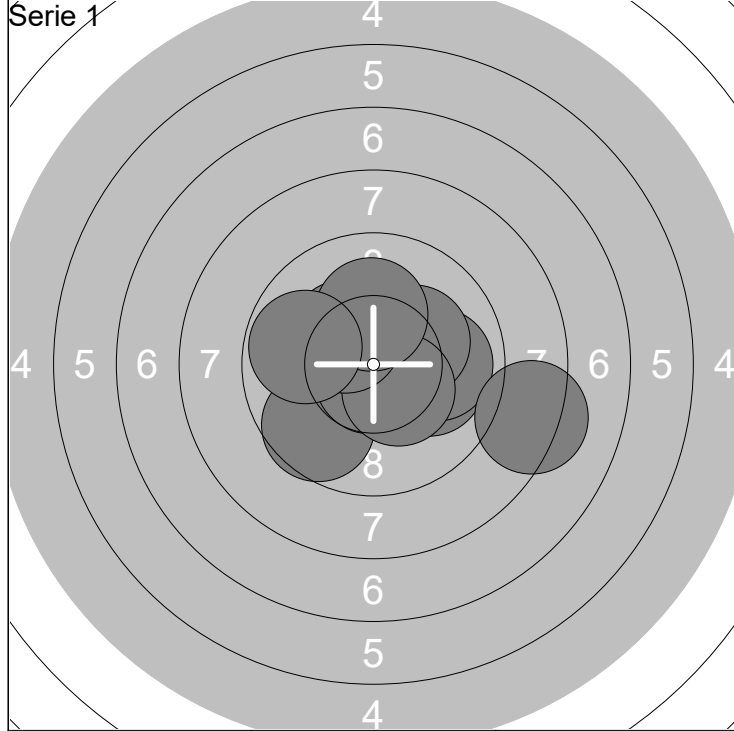

|            |            |       |      |
|------------|------------|-------|------|
| 1: 9.7 ↙   | 6: 10.7x ↓ | Serie | 99.5 |
| 2: 10.0 →  | 7: 10.4x ↘ |       |      |
| 3: 10.0 →  | 8: 10.3x ↗ | Total | 99.5 |
| 4: 10.2x ↗ | 9: 10.1 ↑  |       |      |
| 5: 8.3 →   | 10: 9.8 ←  |       |      |

|             |             |       |       |
|-------------|-------------|-------|-------|
| 11: 10.0 ↗  | 16: 10.0 ←  | Serie | 97.0  |
| 12: 8.7 →   | 17: 10.5x ↘ |       |       |
| 13: 10.4x → | 18: 10.0 ↗  | Total | 196.5 |
| 14: 9.6 ↑   | 19: 8.6 →   |       |       |
| 15: 10.3x ↖ | 20: 8.9 →   |       |       |

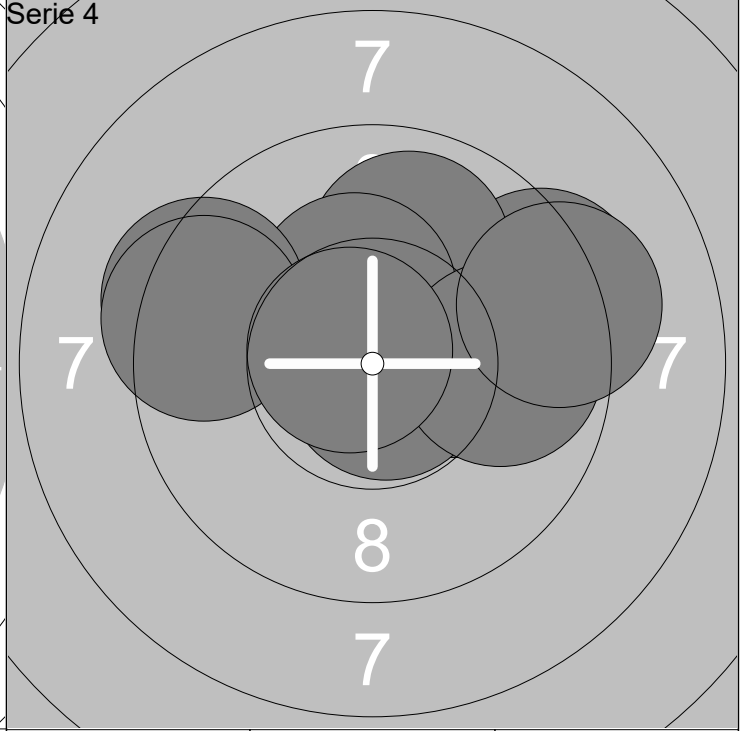
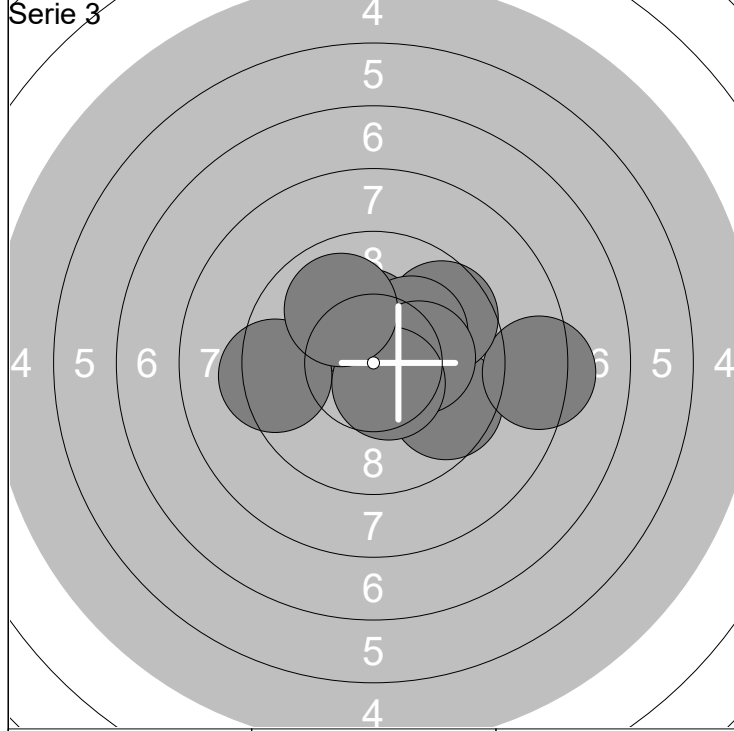

|             |             |       |       |
|-------------|-------------|-------|-------|
| 21: 9.6 →   | 26: 10.2x ↗ | Serie | 98.7  |
| 22: 8.3 →   | 27: 9.4 ←   |       |       |
| 23: 9.7 ↗   | 28: 10.2x → | Total | 295.2 |
| 24: 10.3x ↑ | 29: 10.6x ↘ |       |       |
| 25: 10.4x ↗ | 30: 10.0 ↖  |       |       |

|             |             |       |       |
|-------------|-------------|-------|-------|
| 31: 10.2x → | 36: 9.4 ←   | Serie | 99.0  |
| 32: 10.8x ↘ | 37: 9.8 →   |       |       |
| 33: 9.3 ↗   | 38: 9.4 ←   | Total | 394.2 |
| 34: 9.9 ↑   | 39: 9.2 →   |       |       |
| 35: 10.3x ↑ | 40: 10.7x ↖ |       |       |

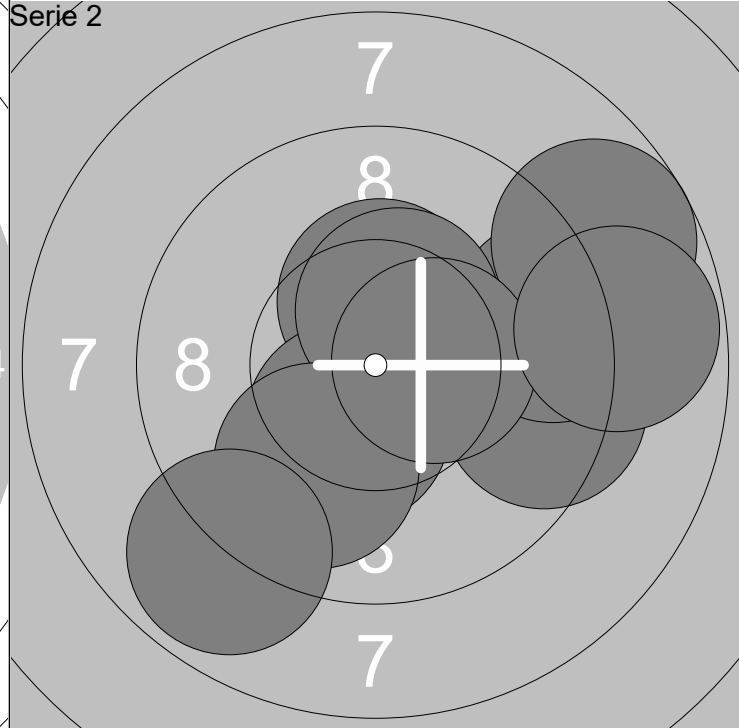
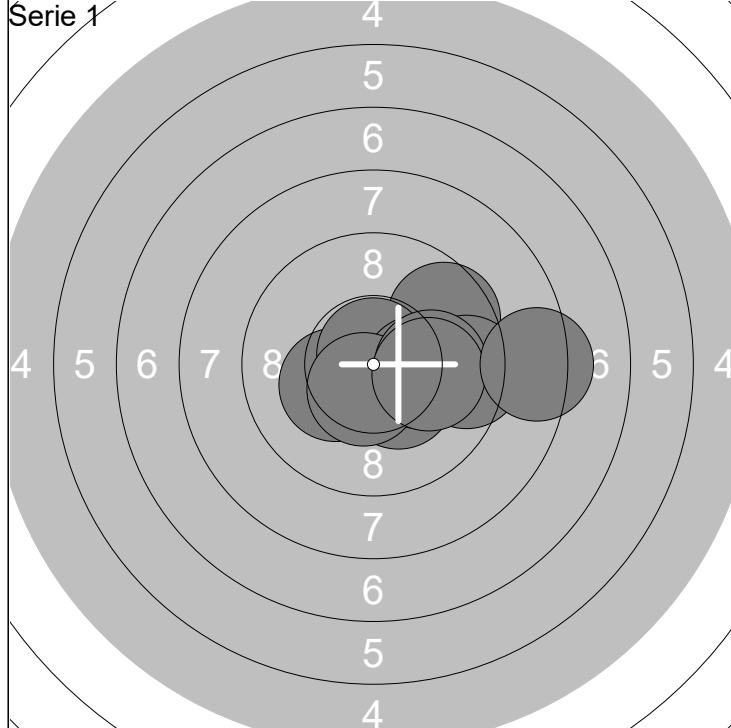

|            |            |       |      |
|------------|------------|-------|------|
| 1: 10.4x ↘ | 6: 9.4 →   | Serie | 99.6 |
| 2: 9.6 ↗   | 7: 10.5x ↓ |       |      |
| 3: 10.3x ↙ | 8: 10.0 →  | Total | 99.6 |
| 4: 10.8x ↑ | 9: 10.0 →  |       |      |
| 5: 10.2x → | 10: 8.4 →  |       |      |

|             |             |       |       |
|-------------|-------------|-------|-------|
| 11: 9.4 →   | 16: 10.4x ↗ | Serie | 96.6  |
| 12: 10.4x ↑ | 17: 9.9 ↓   |       |       |
| 13: 9.3 →   | 18: 8.9 ↓   | Total | 196.2 |
| 14: 8.7 ↗   | 19: 10.4x → |       |       |
| 15: 10.4x ↓ | 20: 8.8 →   |       |       |

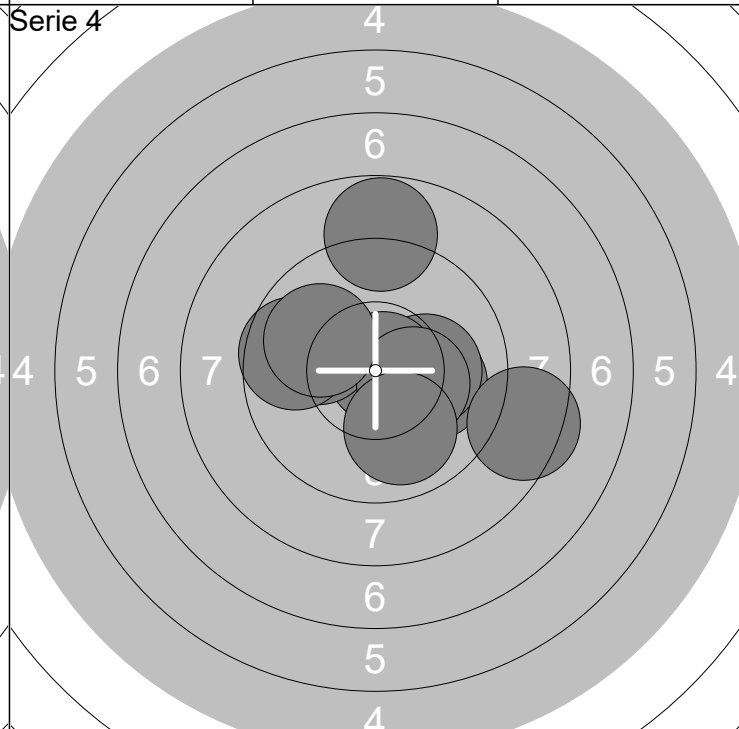
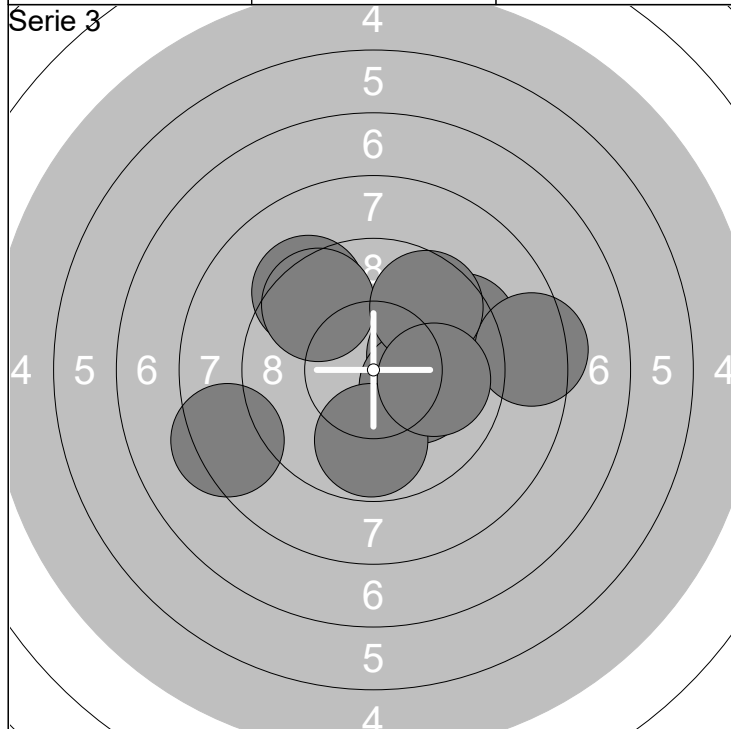

|             |            |       |       |
|-------------|------------|-------|-------|
| 21: 10.1 →  | 26: 9.8 ↓  | Serie | 94.8  |
| 22: 10.2x → | 27: 9.6 ↖  |       |       |
| 23: 9.4 ↗   | 28: 9.6 ↗  | Total | 291.0 |
| 24: 8.4 →   | 29: 8.4 ↖  |       |       |
| 25: 9.3 ↖   | 30: 10.0 → |       |       |

|             |           |       |       |
|-------------|-----------|-------|-------|
| 31: 10.0 →  | 36: 9.6 ↖ | Serie | 97.8  |
| 32: 10.2x → | 37: 8.8 ↑ |       |       |
| 33: 10.8x → | 38: 8.4 → | Total | 388.8 |
| 34: 9.9 ↖   | 39: 9.9 ↖ |       |       |
| 35: 10.3x → | 40: 9.9 ↓ |       |       |

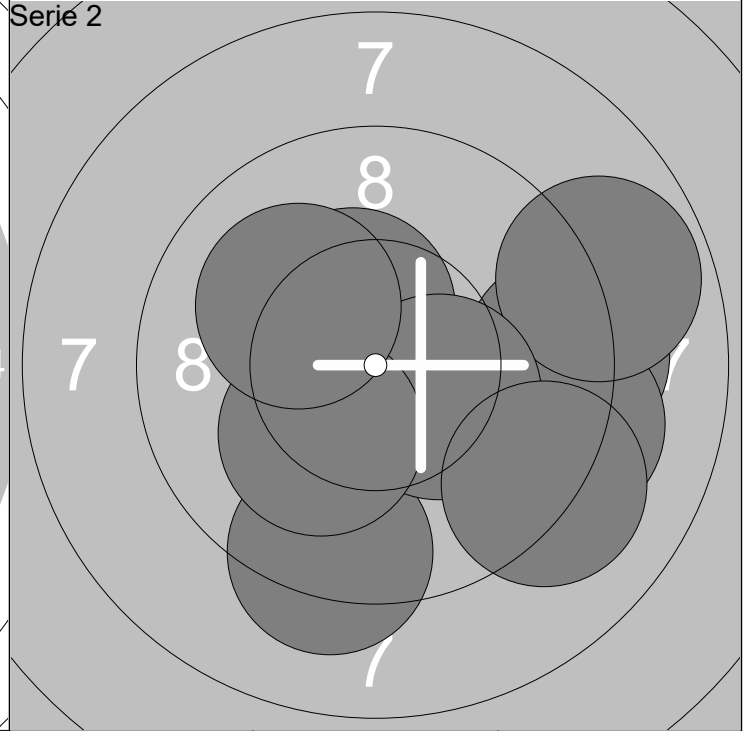
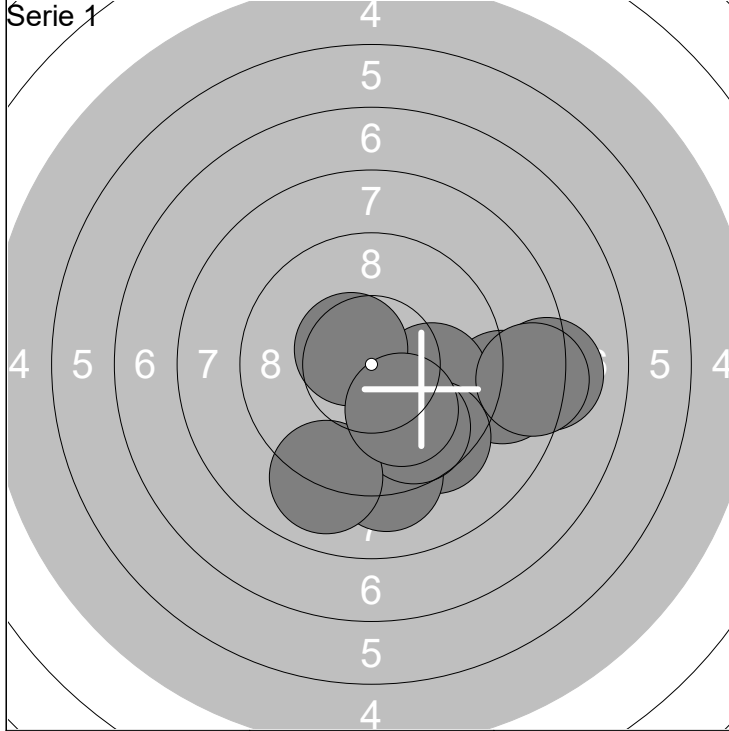

|            |            |       |      |
|------------|------------|-------|------|
| 1: 8.8 →   | 6: 9.2 ↓   | Serie | 93.1 |
| 2: 9.9 →   | 7: 8.4 →   |       |      |
| 3: 9.4 ↓   | 8: 9.7 ↓   | Total | 93.1 |
| 4: 8.1 →   | 9: 9.0 ↓   |       |      |
| 5: 10.5x ↗ | 10: 10.1 ↓ |       |      |

|             |             |       |       |
|-------------|-------------|-------|-------|
| 11: 9.3 →   | 16: 8.8 →   | Serie | 97.5  |
| 12: 10.8x ↓ | 17: 10.3x → |       |       |
| 13: 9.3 ↓   | 18: 10.2x ↓ | Total | 190.6 |
| 14: 9.2 →   | 19: 10.1 ↖  |       |       |
| 15: 10.4x ↗ | 20: 9.1 ↓   |       |       |

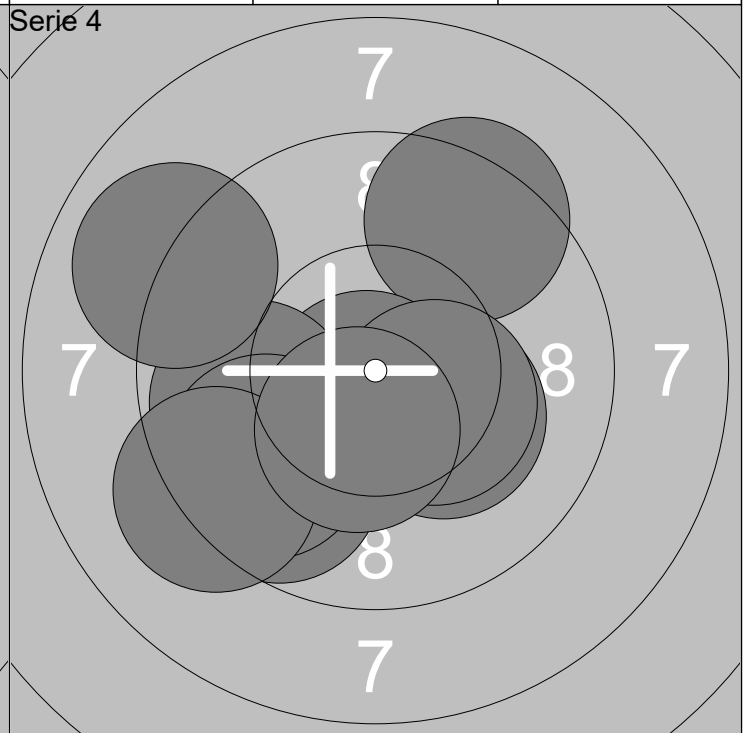
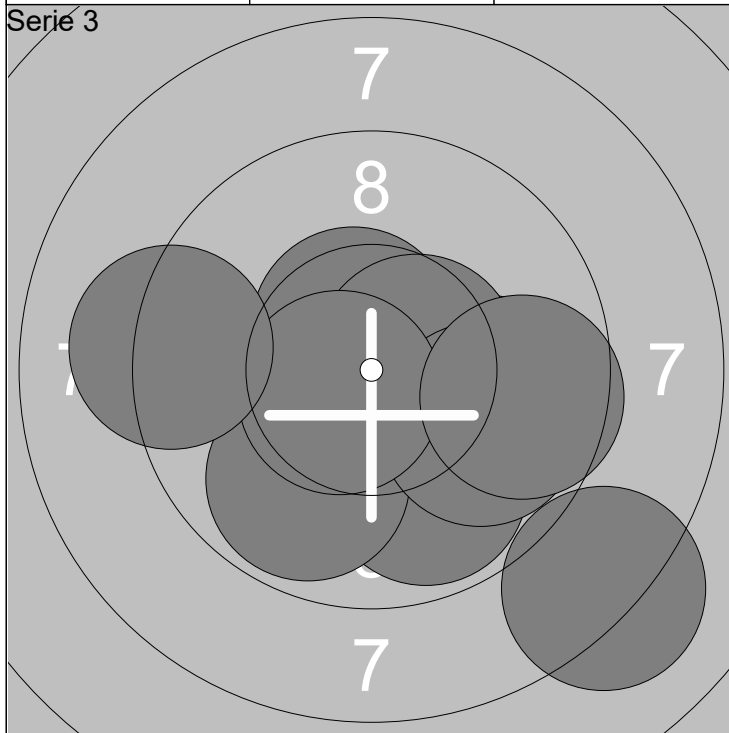

|             |             |       |       |
|-------------|-------------|-------|-------|
| 21: 10.6x ↗ | 26: 9.9 →   | Serie | 98.1  |
| 22: 9.9 ↓   | 27: 10.6x ↙ |       |       |
| 23: 9.9 →   | 28: 8.1 ↓   | Total | 288.7 |
| 24: 10.5x → | 29: 9.2 ←   |       |       |
| 25: 9.8 ↓   | 30: 9.6 →   |       |       |

|             |             |       |       |
|-------------|-------------|-------|-------|
| 31: 10.2x → | 36: 8.9 ↖   | Serie | 98.4  |
| 32: 9.4 ↗   | 37: 10.4x → |       |       |
| 33: 10.7x ↓ | 38: 9.7 ↙   | Total | 387.1 |
| 34: 9.7 ↙   | 39: 9.2 ↙   |       |       |
| 35: 9.8 ←   | 40: 10.4x ↓ |       |       |



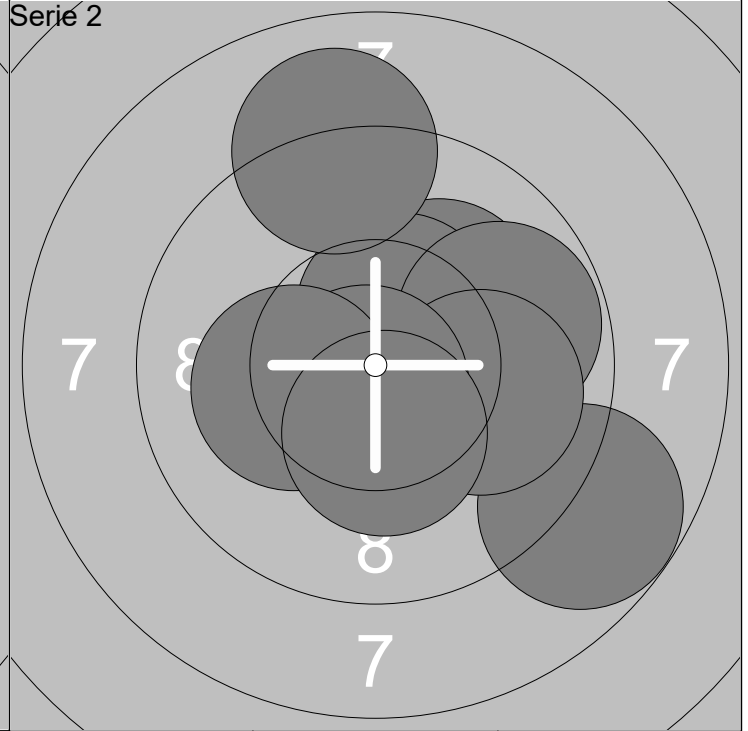
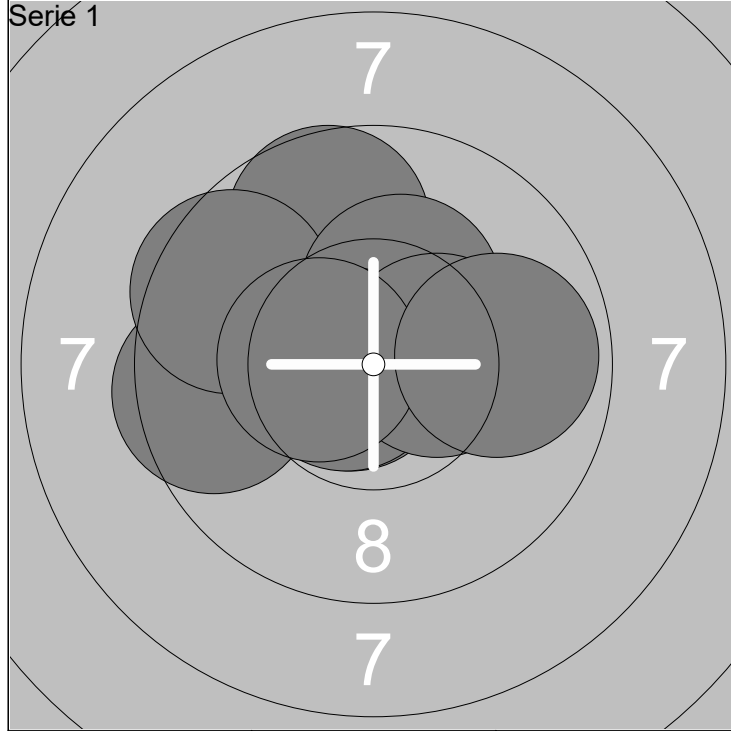

|            |            |       |       |
|------------|------------|-------|-------|
| 1: 9.5 ←   | 6: 10.3x ↗ | Serie | 101.6 |
| 2: 10.7x ← | 7: 10.7x ← |       |       |
| 3: 10.5x ↗ | 8: 10.4x → | Total | 101.6 |
| 4: 9.7 ↗   | 9: 10.5x ← |       |       |
| 5: 9.5 ↖   | 10: 9.8 →  |       |       |

|             |             |       |       |
|-------------|-------------|-------|-------|
| 11: 10.2x ↗ | 16: 10.0 →  | Serie | 100.1 |
| 12: 10.5x ↓ | 17: 10.7x ↓ |       |       |
| 13: 10.5x ↗ | 18: 10.2x ← | Total | 201.7 |
| 14: 8.8 ↘   | 19: 9.0 ↗   |       |       |
| 15: 9.8 →   | 20: 10.4x ↓ |       |       |

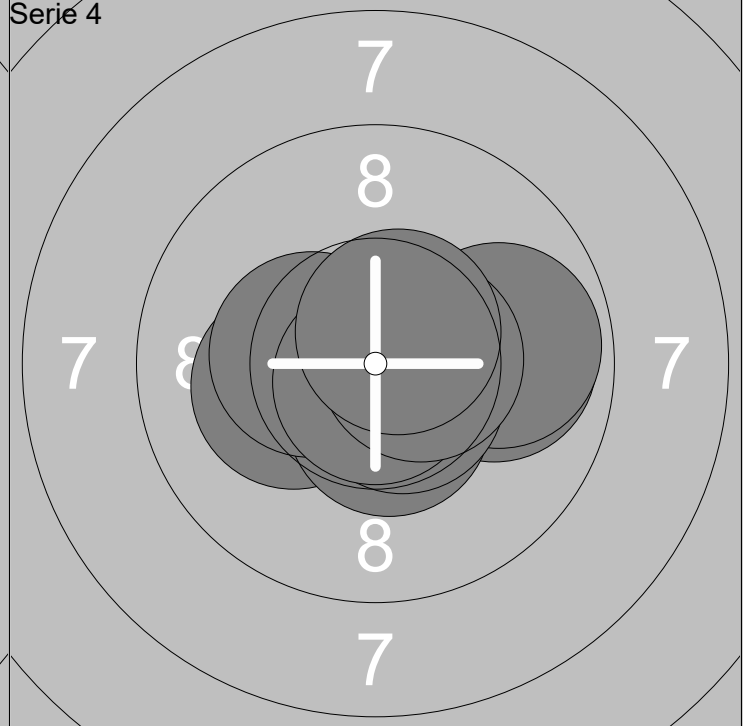
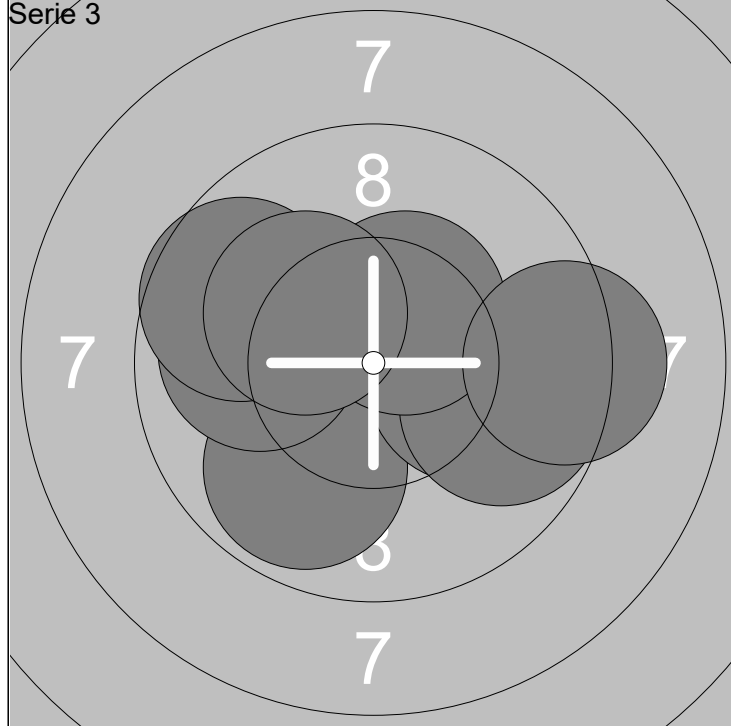

|             |             |       |       |
|-------------|-------------|-------|-------|
| 21: 10.2x ← | 26: 9.8 →   | Serie | 100.3 |
| 22: 10.8x ↖ | 27: 10.4x ↗ |       |       |
| 23: 9.9 ↓   | 28: 9.7 ←   | Total | 302.0 |
| 24: 10.1 →  | 29: 10.2x ↖ |       |       |
| 25: 9.9 ←   | 30: 9.3 →   |       |       |

|             |             |       |       |
|-------------|-------------|-------|-------|
| 31: 10.2x → | 36: 10.6x ↓ | Serie | 103.5 |
| 32: 9.9 →   | 37: 10.4x ← |       |       |
| 33: 10.2x ← | 38: 10.8x ↓ | Total | 405.5 |
| 34: 10.5x ↓ | 39: 10.5x → |       |       |
| 35: 9.8 →   | 40: 10.6x ↗ |       |       |

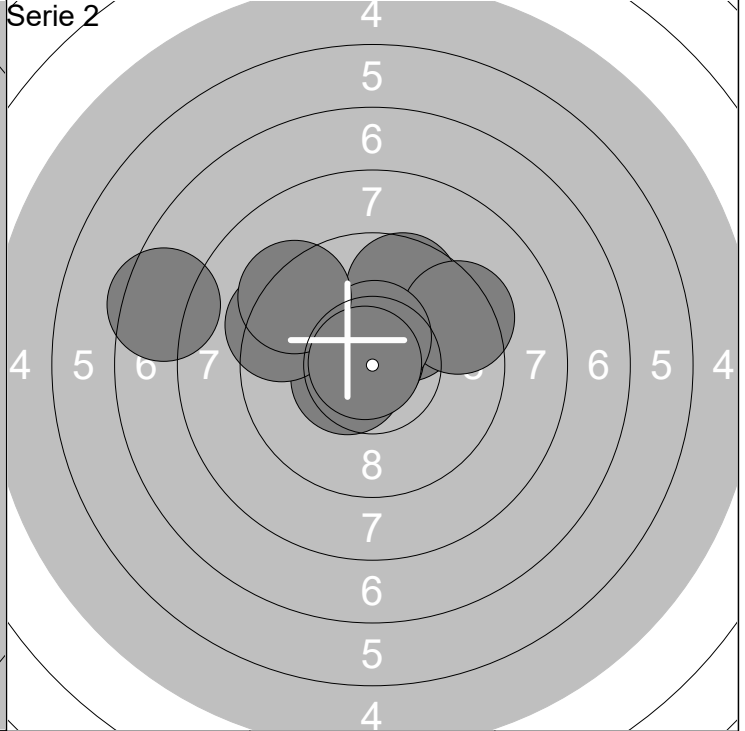
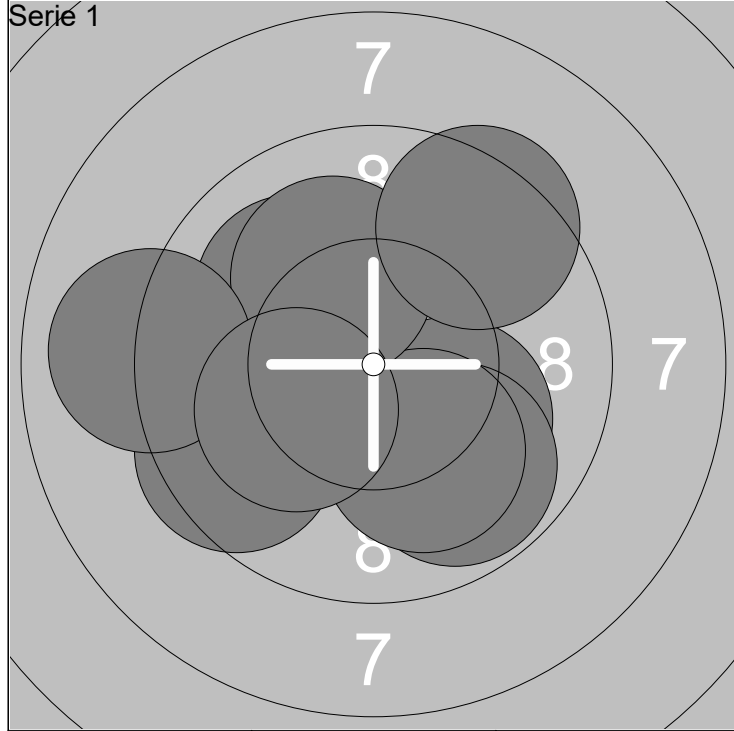

|           |            |       |      |
|-----------|------------|-------|------|
| 1: 10.1 ↘ | 6: 10.1 ↗  | Serie | 98.1 |
| 2: 9.8 ↘  | 7: 9.5 ↙   |       |      |
| 3: 10.1 ↘ | 8: 9.4 ↗   | Total | 98.1 |
| 4: 10.0 ↖ | 9: 9.0 ↙   |       |      |
| 5: 10.0 ↗ | 10: 10.1 ↙ |       |      |

|             |             |       |       |
|-------------|-------------|-------|-------|
| 11: 10.5x ↙ | 16: 9.4 ↙   | Serie | 98.0  |
| 12: 10.1 ↗  | 17: 9.4 ↗   |       |       |
| 13: 9.7 ↗   | 18: 10.5x ↗ | Total | 196.1 |
| 14: 10.8x ↖ | 19: 9.3 ↙   |       |       |
| 15: 7.5 ↙   | 20: 10.8x ↙ |       |       |

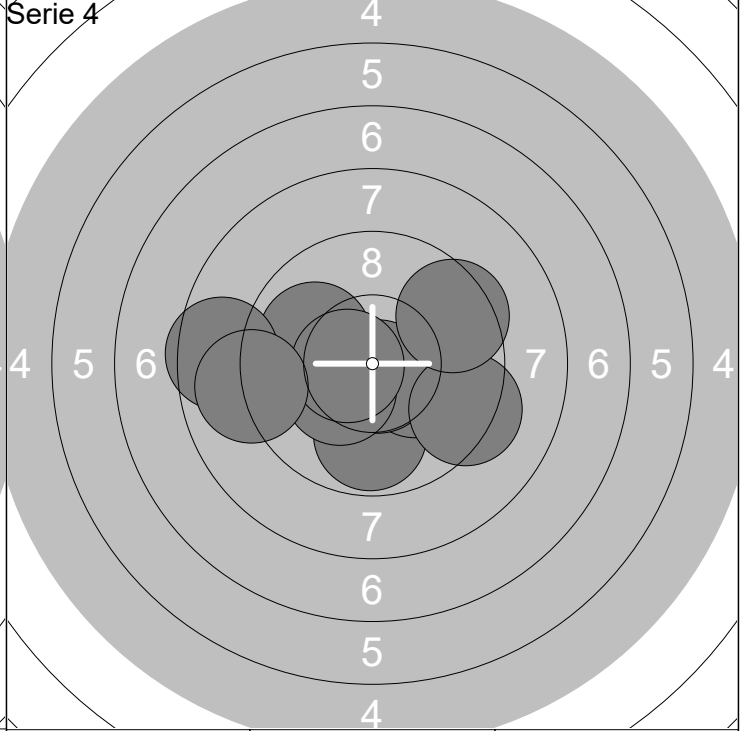
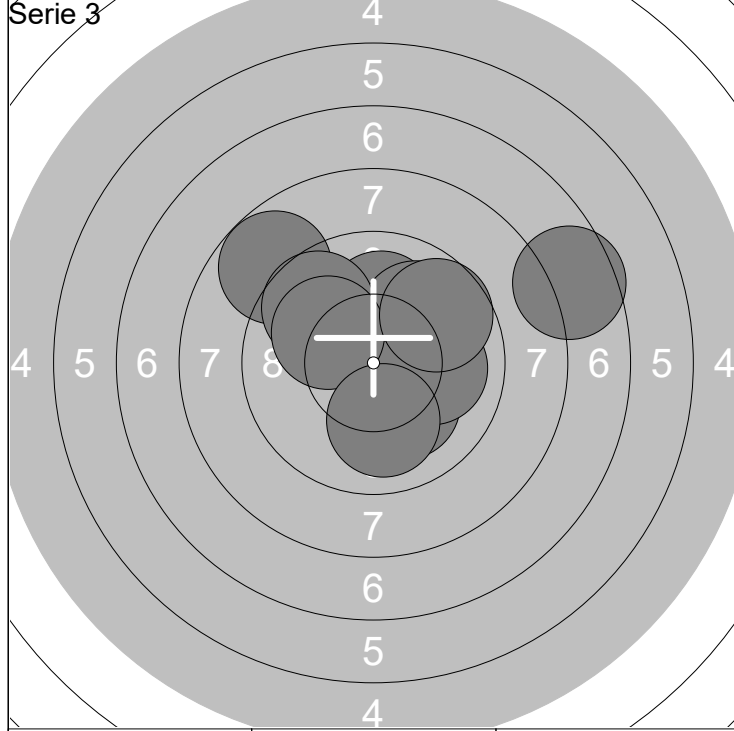

|            |            |       |       |
|------------|------------|-------|-------|
| 21: 10.1 ↗ | 26: 9.7 ↙  | Serie | 96.0  |
| 22: 9.9 ↗  | 27: 7.6 →  |       |       |
| 23: 10.1 ↘ | 28: 10.1 ↙ | Total | 292.1 |
| 24: 10.0 → | 29: 9.7 ↗  |       |       |
| 25: 8.8 ↖  | 30: 10.0 ↘ |       |       |

|             |             |       |       |
|-------------|-------------|-------|-------|
| 31: 9.8 ↘   | 36: 8.5 ↙   | Serie | 97.8  |
| 32: 10.2x → | 37: 10.5x ↙ |       |       |
| 33: 10.7x ↘ | 38: 9.3 →   | Total | 389.9 |
| 34: 10.0 ↙  | 39: 9.5 ↗   |       |       |
| 35: 10.3x ↙ | 40: 9.0 ↙   |       |       |

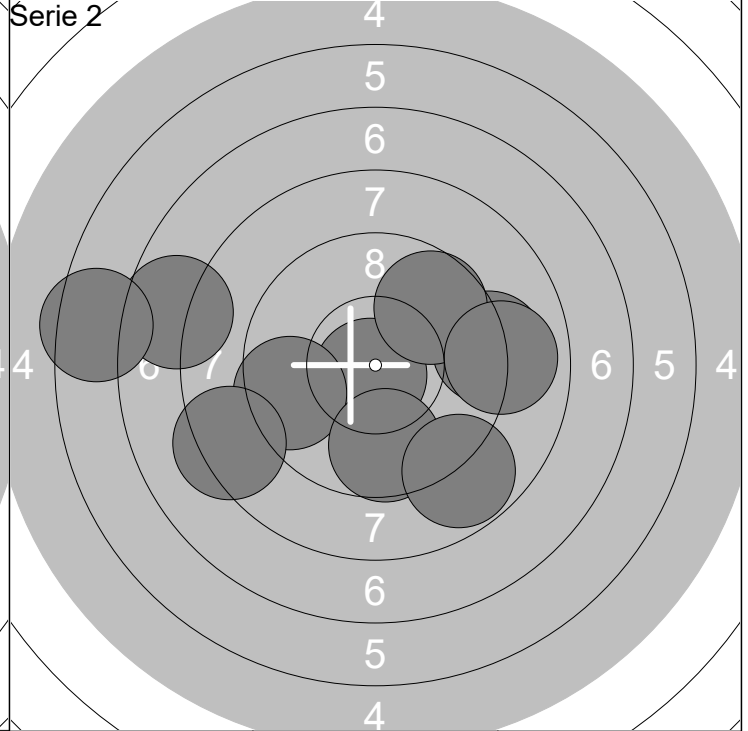
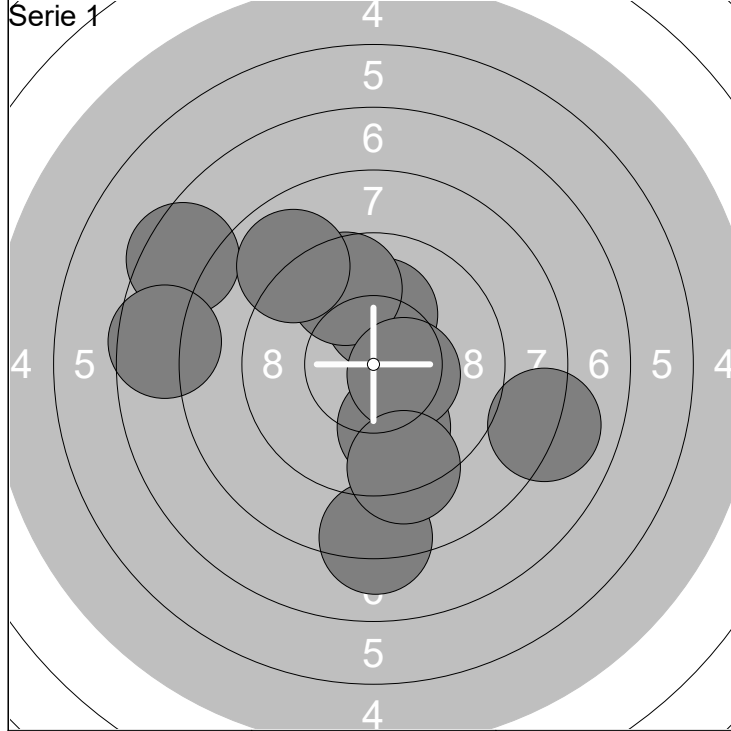

|               |            |               |
|---------------|------------|---------------|
| 1: 7.5 ↖      | 6: 9.7 ↗   | Serie<br>89.7 |
| 2: 7.6 ←      | 7: 10.5x → |               |
| 3: 9.9 ↓      | 8: 9.2 ↓   |               |
| 4: 10.1 ↑     | 9: 8.9 ↗   |               |
| 5: 8.2 ↓      | 10: 8.1 ↘  |               |
| Total<br>89.7 |            |               |

|                |           |               |
|----------------|-----------|---------------|
| 11: 9.1 →      | 16: 9.5 ← | Serie<br>89.0 |
| 12: 10.8x ↙    | 17: 9.7 ↓ |               |
| 13: 9.7 ↗      | 18: 6.5 ← |               |
| 14: 7.7 ←      | 19: 8.3 ← |               |
| 15: 8.9 →      | 20: 8.8 ↘ |               |
| Total<br>178.7 |           |               |

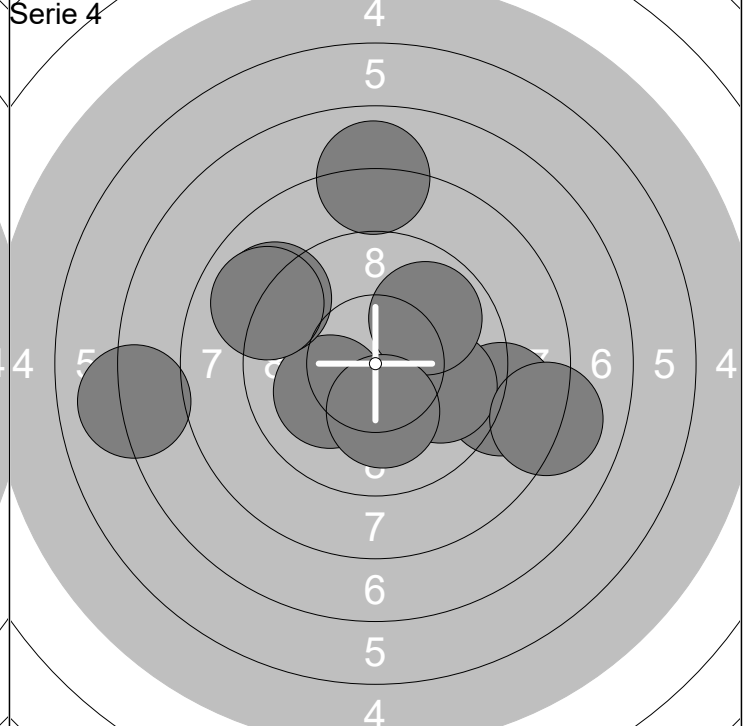
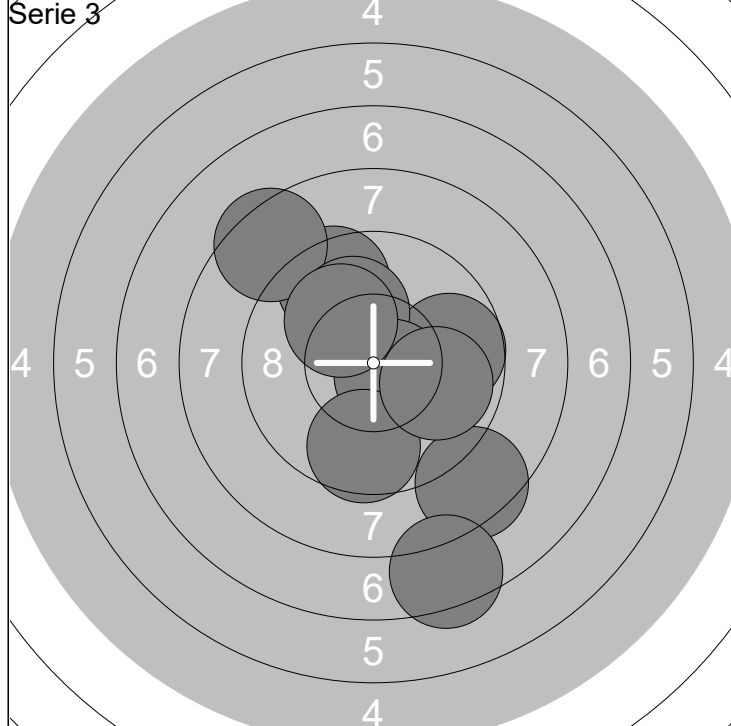

|                |             |               |
|----------------|-------------|---------------|
| 21: 9.5 ↗      | 26: 10.6x ↘ | Serie<br>93.8 |
| 22: 8.4 ↗      | 27: 7.4 ↓   |               |
| 23: 8.5 ↘      | 28: 9.6 ↓   |               |
| 24: 9.7 →      | 29: 9.9 →   |               |
| 25: 10.1 ↗     | 30: 10.1 ↗  |               |
| Total<br>272.5 |             |               |

|                |             |               |
|----------------|-------------|---------------|
| 31: 8.9 →      | 36: 8.1 →   | Serie<br>90.1 |
| 32: 9.8 →      | 37: 7.1 ←   |               |
| 33: 9.9 ↗      | 38: 9.0 ←   |               |
| 34: 8.0 ↑      | 39: 10.2x ↓ |               |
| 35: 10.1 ←     | 40: 9.0 ←   |               |
| Total<br>362.6 |             |               |

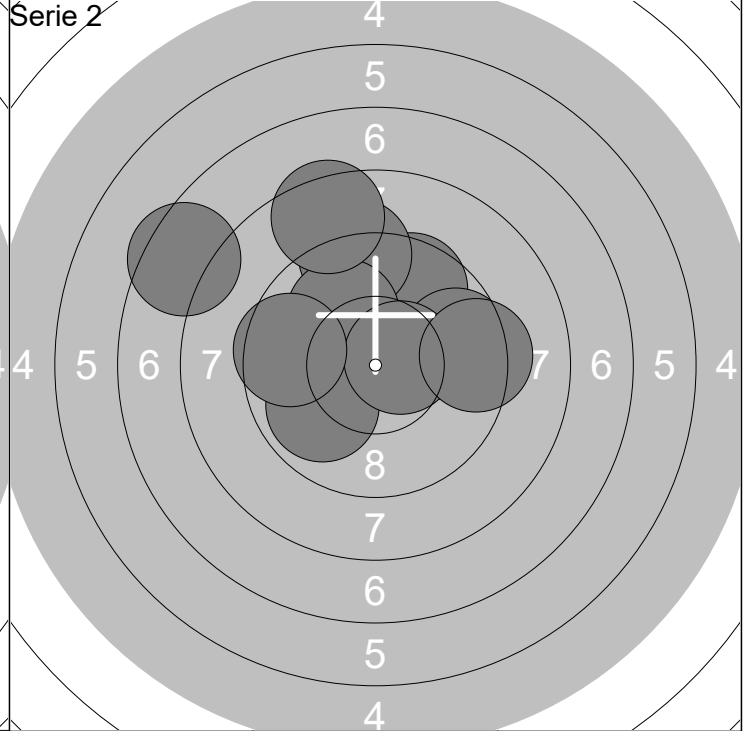
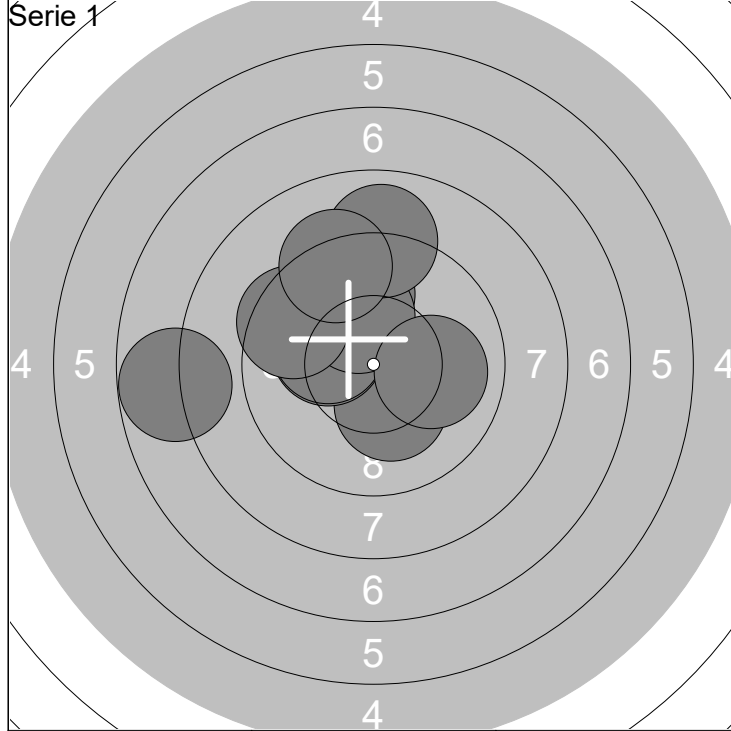

|            |           |       |      |
|------------|-----------|-------|------|
| 1: 10.3x ↓ | 6: 9.5 ↙  | Serie | 96.2 |
| 2: 10.2x ↙ | 7: 10.0 → |       |      |
| 3: 9.8 ↑   | 8: 7.8 ←  | Total | 96.2 |
| 4: 10.2x ↙ | 9: 9.0 ↑  |       |      |
| 5: 10.1 ↑  | 10: 9.3 ↗ |       |      |

|            |             |       |       |
|------------|-------------|-------|-------|
| 11: 9.6 ↗  | 16: 9.6 →   | Serie | 93.9  |
| 12: 7.5 ↙  | 17: 8.5 ↑   |       |       |
| 13: 9.2 ↑  | 18: 10.6x → | Total | 190.1 |
| 14: 10.0 ↖ | 19: 9.6 ←   |       |       |
| 15: 9.9 ↙  | 20: 9.4 →   |       |       |

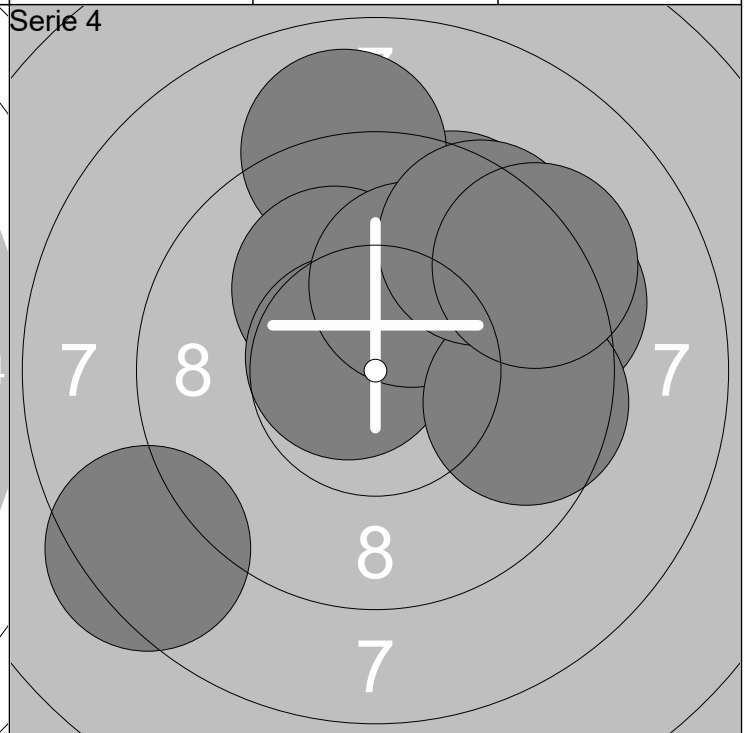
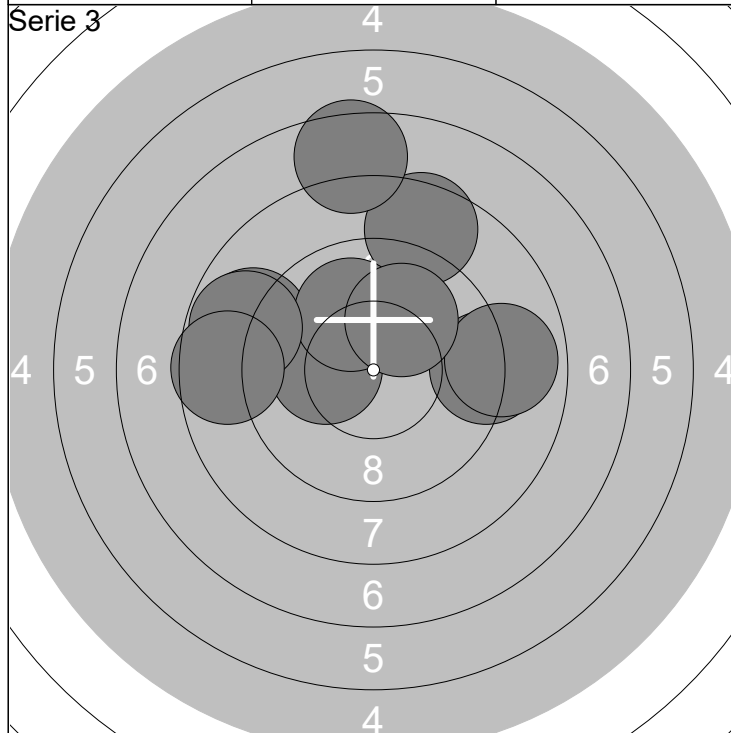

|             |            |       |       |
|-------------|------------|-------|-------|
| 21: 8.9 ↙   | 26: 10.0 ↗ | Serie | 90.6  |
| 22: 9.1 →   | 27: 7.5 ↑  |       |       |
| 23: 8.6 ↑   | 28: 8.8 ↙  | Total | 280.7 |
| 24: 10.2x ↙ | 29: 10.0 ↗ |       |       |
| 25: 8.9 →   | 30: 8.6 ←  |       |       |

|            |             |       |       |
|------------|-------------|-------|-------|
| 31: 9.6 ↗  | 36: 10.7x ↙ | Serie | 95.6  |
| 32: 8.4 ↙  | 37: 10.1 ↑  |       |       |
| 33: 9.0 ↑  | 38: 9.6 →   | Total | 376.3 |
| 34: 9.3 ↗  | 39: 9.5 ↗   |       |       |
| 35: 10.1 ↖ | 40: 9.3 ↗   |       |       |

Serie 1

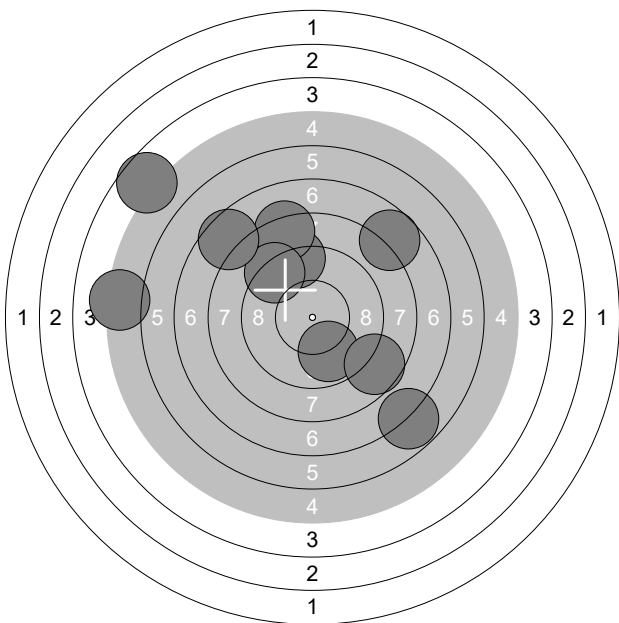

|          |           |       |      |
|----------|-----------|-------|------|
| 1: 9.1 ↗ | 6: 7.5 ↖  | Serie | 76.7 |
| 2: 8.2 ↗ | 7: 6.8 ↘  |       |      |
| 3: 4.6 ↗ | 8: 7.7 ↗  | Total | 76.7 |
| 4: 9.2 ↗ | 9: 8.6 ↘  |       |      |
| 5: 9.8 ↘ | 10: 5.2 ← |       |      |

Serie 2

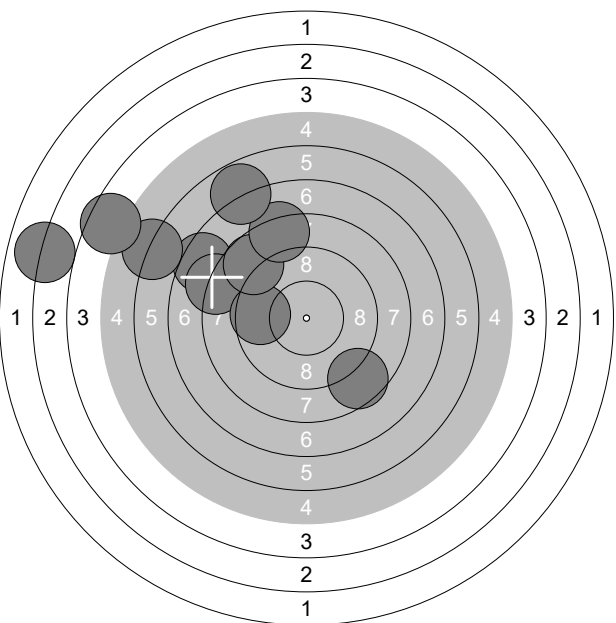

|           |           |       |       |
|-----------|-----------|-------|-------|
| 11: 7.5 ↖ | 16: 8.7 ↗ | Serie | 71.1  |
| 12: 3.0 ← | 17: 6.0 ↖ |       |       |
| 13: 8.6 ↘ | 18: 8.3 ↗ | Total | 147.8 |
| 14: 8.1 ↗ | 19: 4.5 ↖ |       |       |
| 15: 9.6 ← | 20: 6.8 ↗ |       |       |

Serie 3

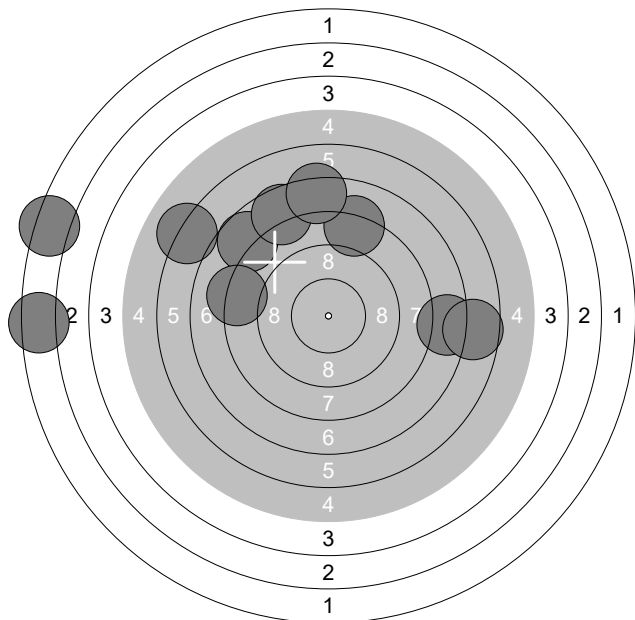

|           |           |       |       |
|-----------|-----------|-------|-------|
| 21: 7.4 → | 26: 7.6 ↗ | Serie | 63.5  |
| 22: 8.1 ↗ | 27: 6.6 → |       |       |
| 23: 7.7 ↗ | 28: 2.2 ← | Total | 211.3 |
| 24: 6.1 ↗ | 29: 2.3 ← |       |       |
| 25: 8.2 ← | 30: 7.3 ↗ |       |       |

Serie 4

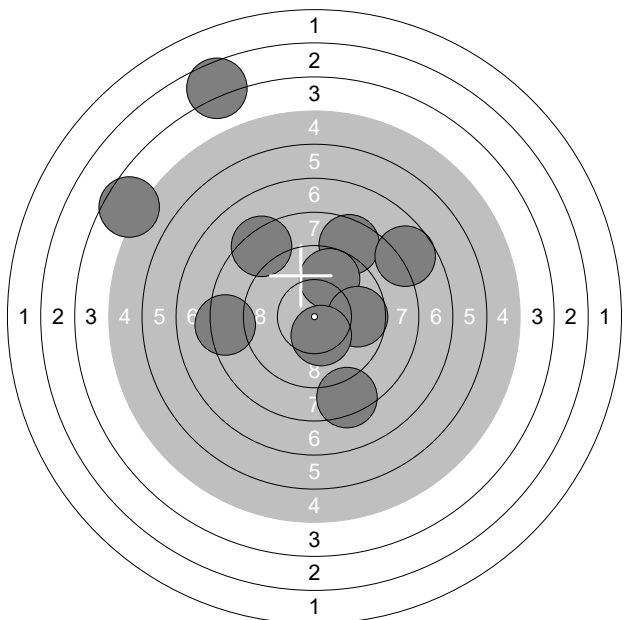

|           |             |       |       |
|-----------|-------------|-------|-------|
| 31: 8.6 ↗ | 36: 9.7 ↗   | Serie | 79.2  |
| 32: 3.6 ↗ | 37: 4.6 ↖   |       |       |
| 33: 7.7 ↗ | 38: 9.7 →   | Total | 290.5 |
| 34: 8.3 ↖ | 39: 8.3 ←   |       |       |
| 35: 8.4 ↘ | 40: 10.3x ↘ |       |       |