

1:	9.8	←
2:	10.6x	↘
3:	10.5x	↗
4:	10.0	↘
5:	10.2x	↗
Serie		51.1
Total		51.1

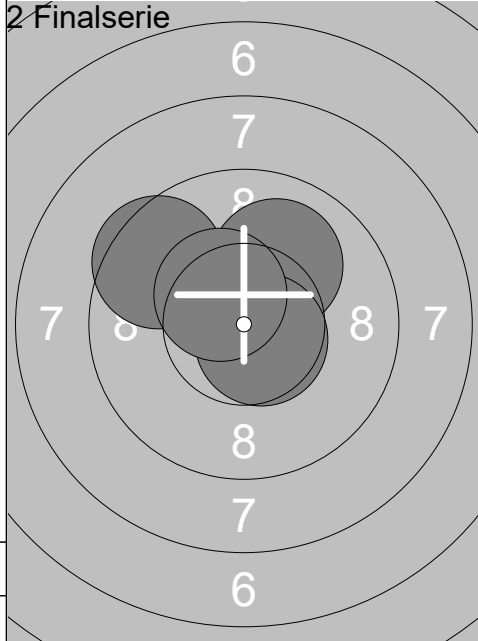

1:	9.5	↖
2:	10.7x	↗
3:	10.0	↗
4:	10.6x	↘
5:	10.4x	↖
Serie		51.2
Total		102.3

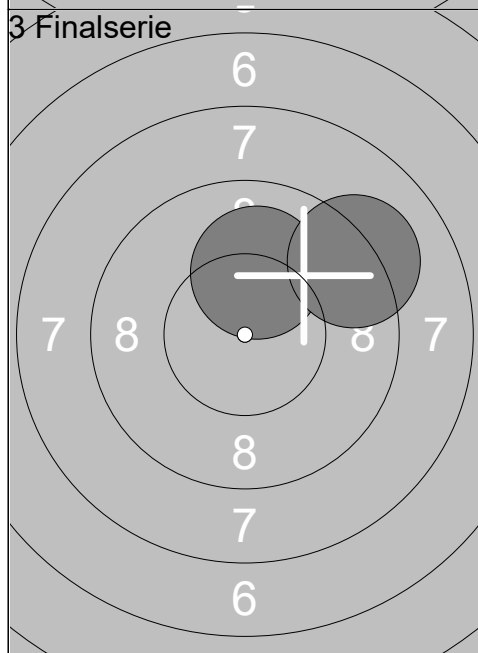

1:	10.1	↗
2:	9.1	↗
Serie		19.2
Total		121.5

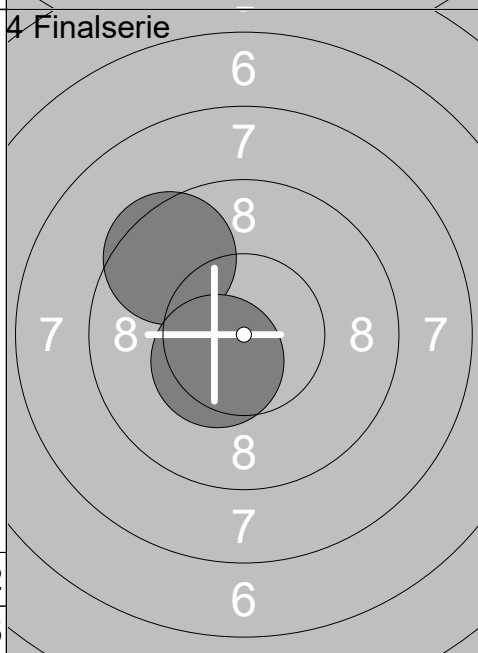

1:	9.5	↖
2:	10.5x	↘
Serie		20.0
Total		141.5

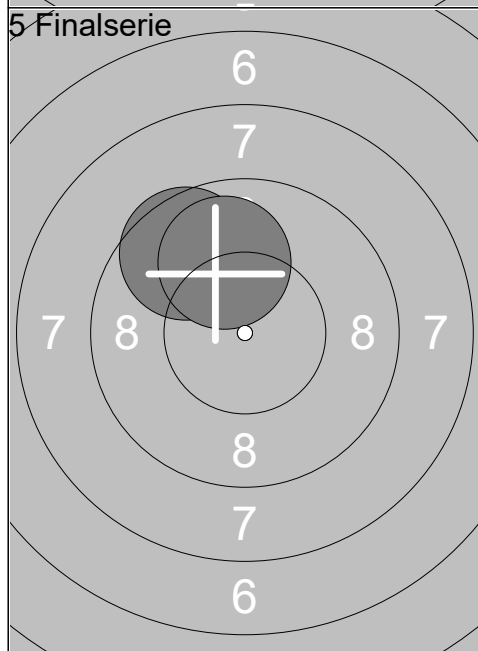

1:	9.6	↖
2:	9.9	↗
Serie		19.5
Total		161.0

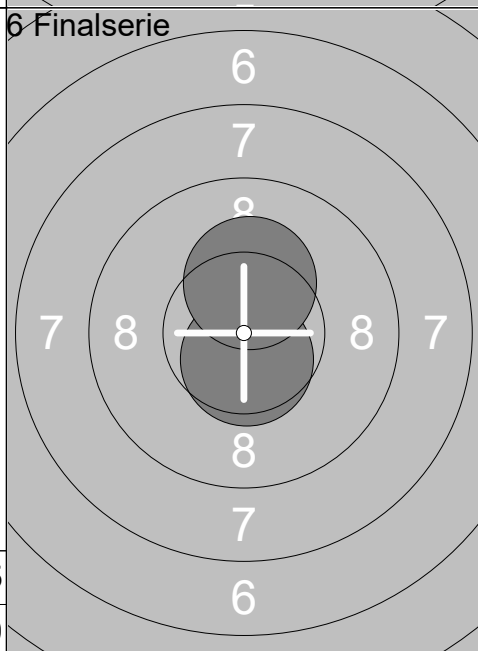

1:	10.6x	↘
2:	10.3x	↗
Serie		20.9
Total		181.9

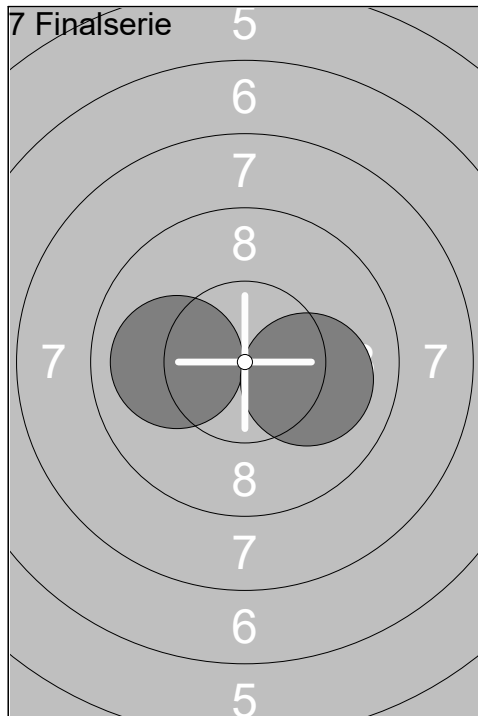

1: 10.0 ←
2: 10.1 →

Serie	20.1
Total	202.0

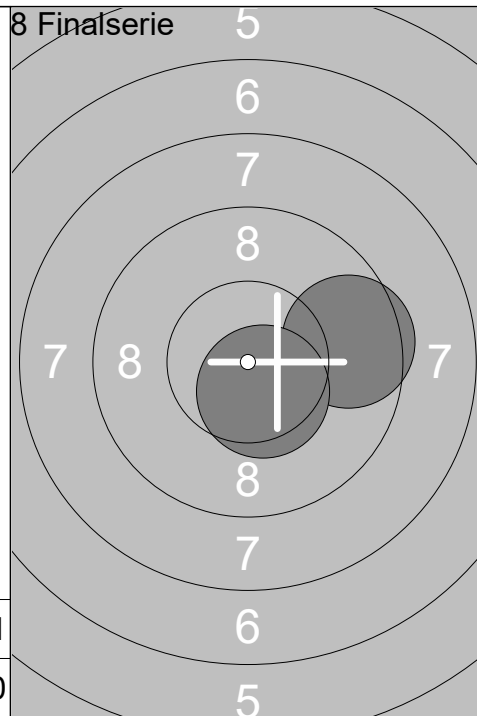

1: 9.5 →
2: 10.5x ↘

Serie	20.0
Total	222.0

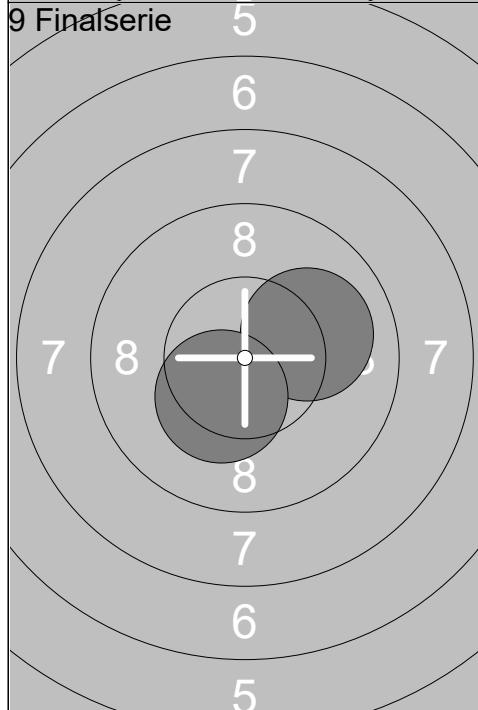

1: 10.1 →
2: 10.3x ↘

Serie	20.4
Total	242.4

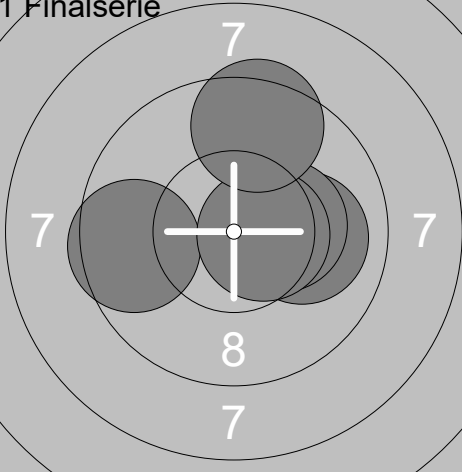
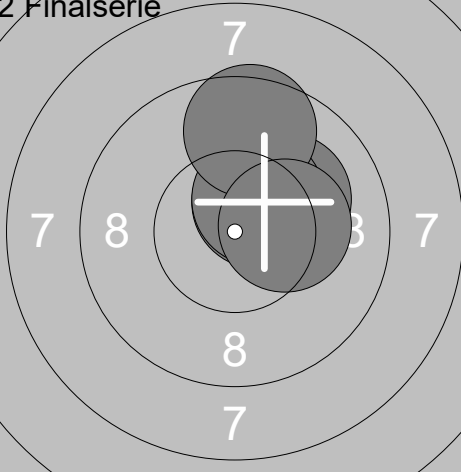
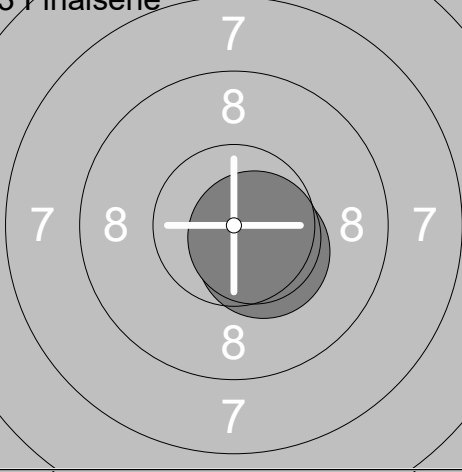
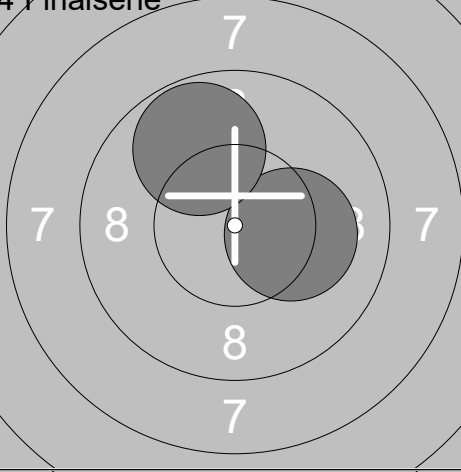
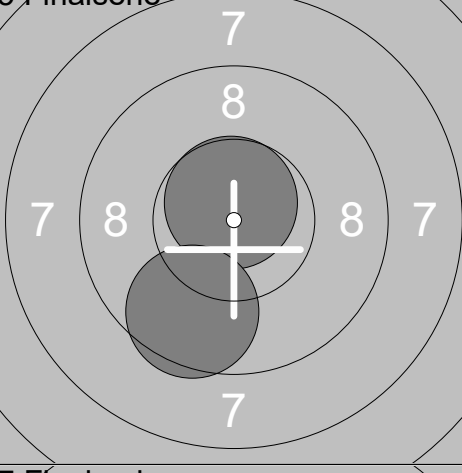
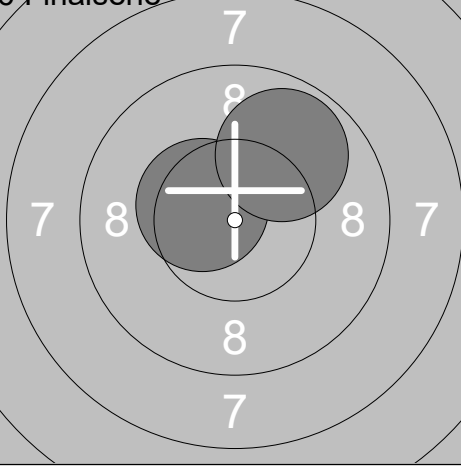
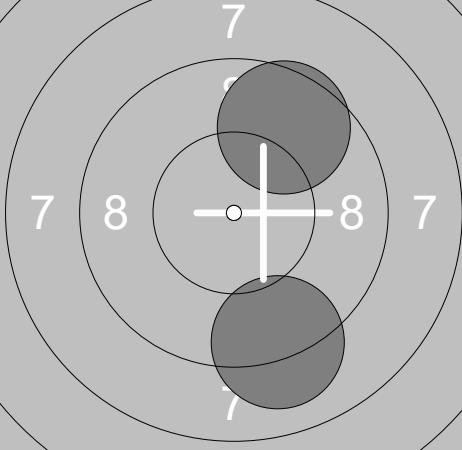
Skjutlag 1	Tavla 13	Anna Normann	
Dubbelluften Final		I 16/LV 6 Skytteförening	Final
14.10.2018		Dubbelluften Söndag	Söraby SKF
1 Finalserie		1: 10.0 → 2: 9.6 ← 3: 10.3x → 4: 10.6x → 5: 9.5 ↑	2 Finalserie
	Serie 50.0 Total 50.0		
			1: 10.1 ↗ 2: 10.4x ↗ 3: 10.4x ↗ 4: 9.6 ↑ 5: 10.3x →
			Serie 50.8 Total 100.8
3 Finalserie		1: 10.4x ↘ 2: 10.6x ↘	4 Finalserie
	Serie 21.0 Total 121.8		
			1: 10.2x → 2: 9.8 ↖
			Serie 20.0 Total 141.8
5 Finalserie		1: 10.7x ↑ 2: 9.6 ↓	6 Finalserie
	Serie 20.3 Total 162.1		
			1: 10.5x ↖ 2: 9.8 ↗
			Serie 20.3 Total 182.4
7 Finalserie		1: 9.6 ↗ 2: 9.1 ↓	
	Serie 18.7 Total 201.1		

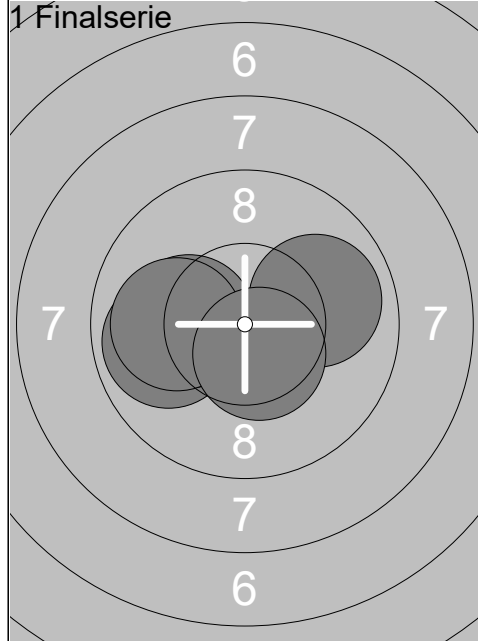

1:	9.9	←
2:	10.2x	←
3:	9.9	→
4:	10.0	←
5:	10.5x	↓
<hr/>		
Serie	50.5	
Total	50.5	

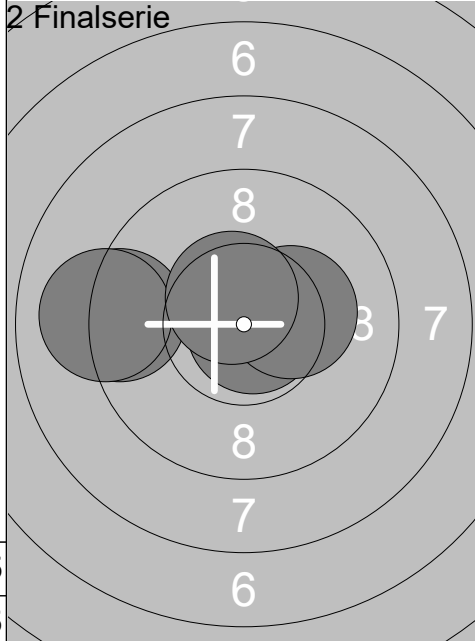

1:	10.8x	→
2:	9.3	←
3:	10.3x	→
4:	9.1	←
5:	10.6x	↖
<hr/>		
Serie	50.1	
Total	100.6	

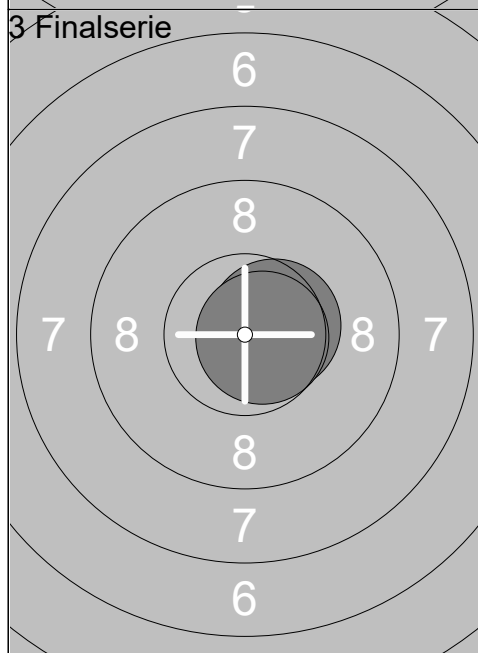

1:	10.5x	→
2:	10.7x	→
<hr/>		
Serie	21.2	
Total	121.8	

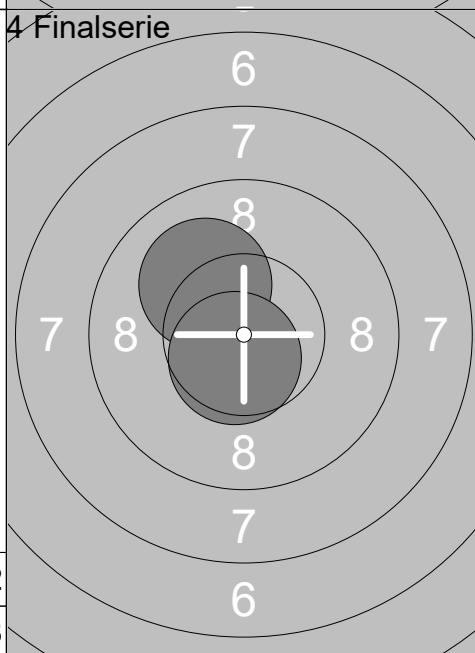

1:	10.1	↖
2:	10.6x	↓
<hr/>		
Serie	20.7	
Total	142.5	

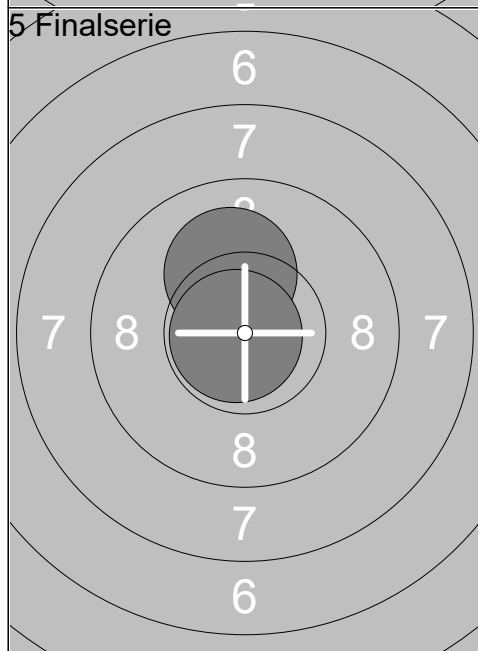

1:	10.1	↖
2:	10.8x	←
<hr/>		
Serie	20.9	
Total	163.4	

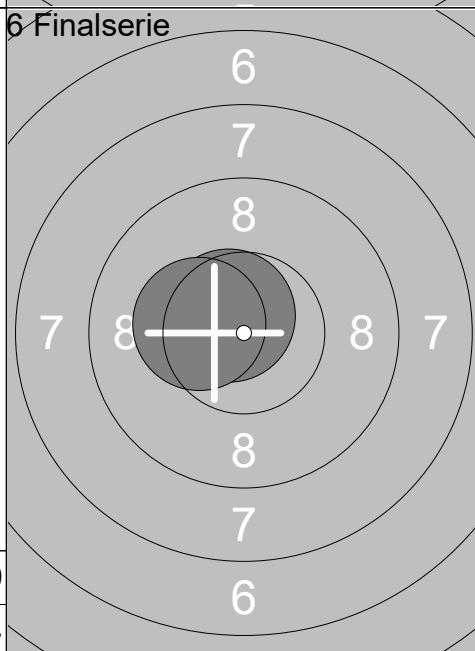

1:	10.7x	↖
2:	10.3x	←
<hr/>		
Serie	21.0	
Total	184.4	

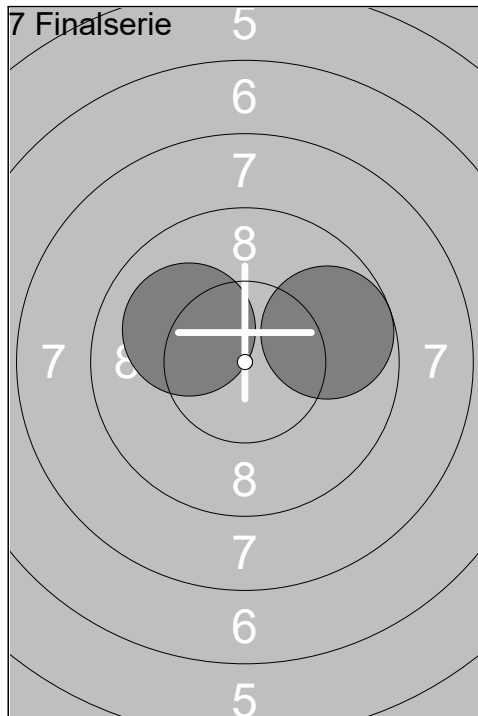

1: 9.8 →
2: 10.1 ↖

Serie	19.9
Total	204.3

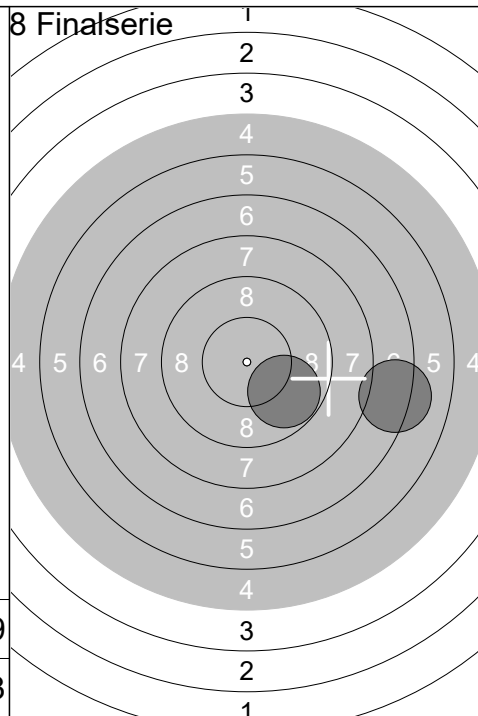

1: 7.2 →
2: 9.8 ↘

Serie	17.0
Total	221.3

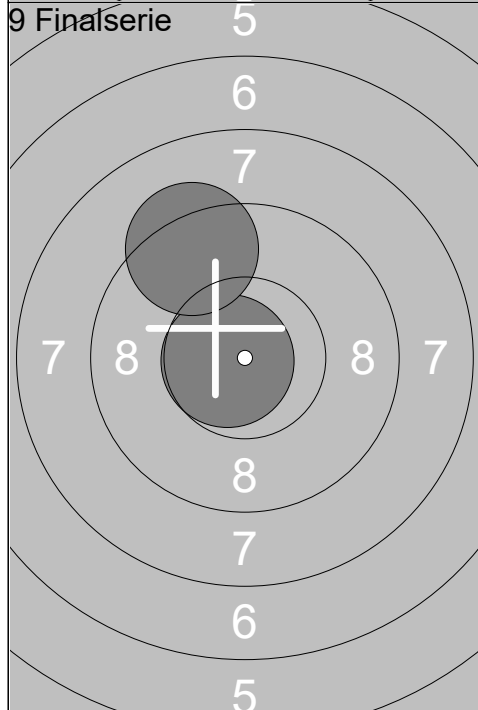

1: 10.7x ←
2: 9.3 ↗

Serie	20.0
Total	241.3

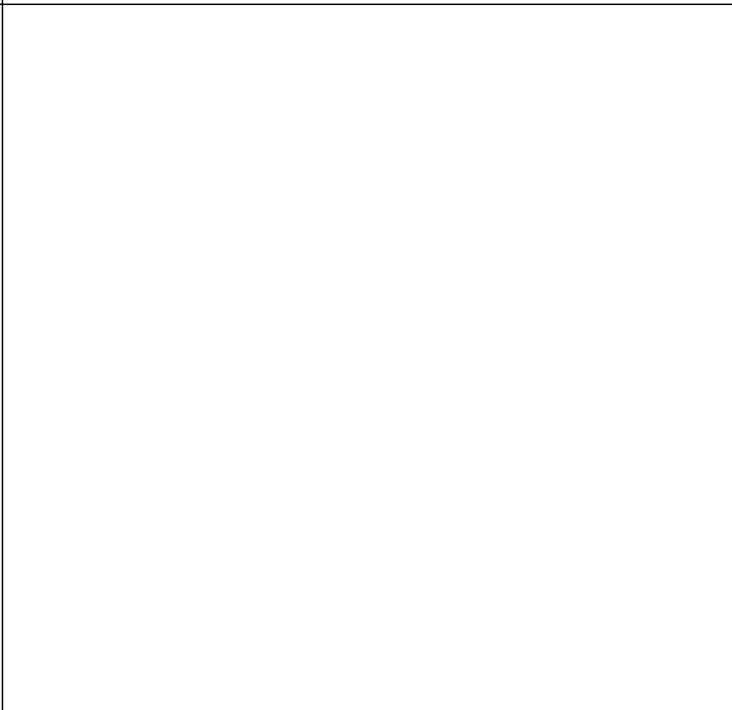
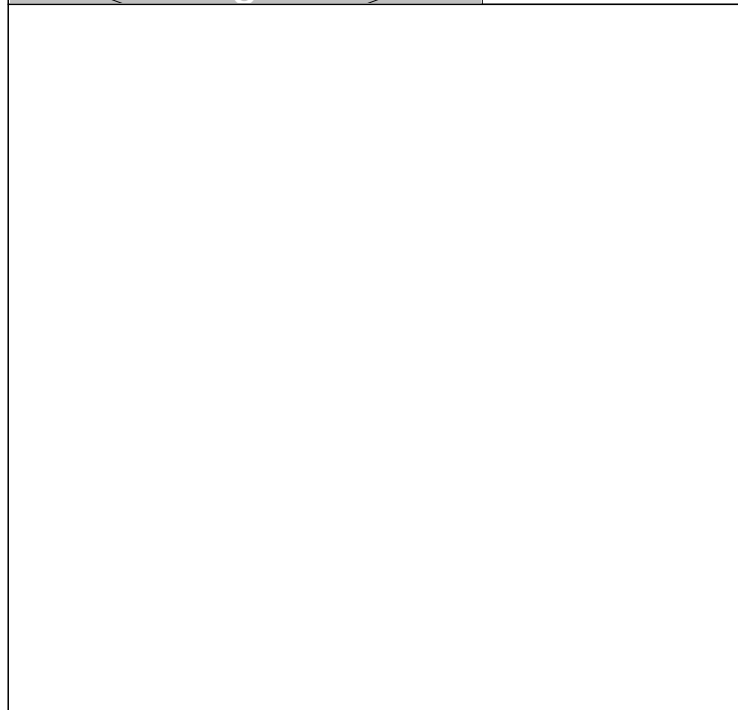

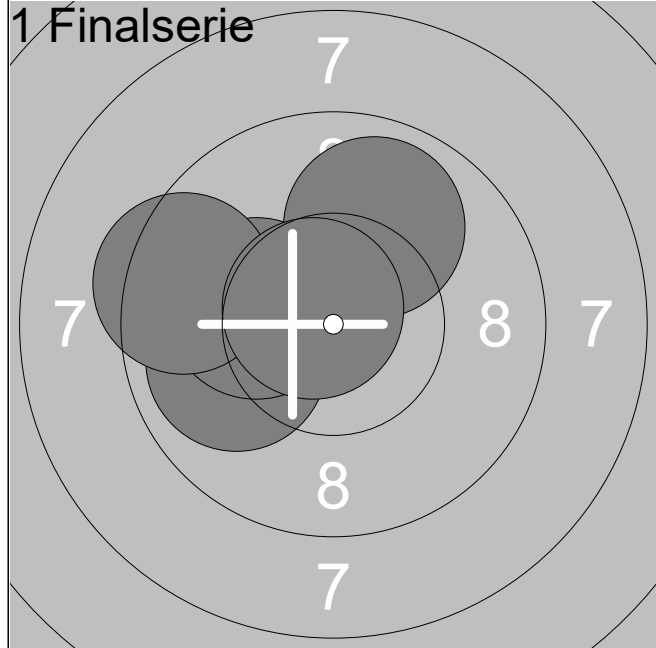



1:	9.9	←
2:	10.2x	←
3:	9.9	↑
4:	9.4	←
5:	10.7x	↖
Serie		50.1
Total		50.1

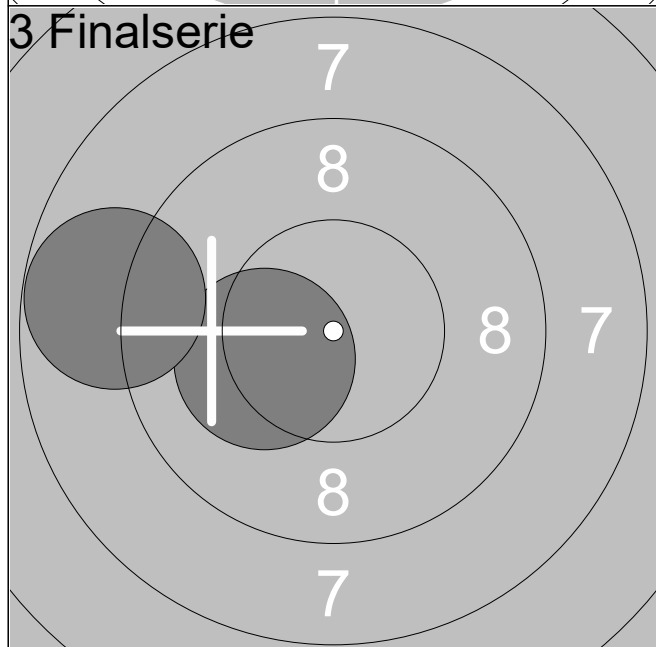

1:	8.3	←
2:	10.5x	↑
3:	8.6	←
4:	9.9	↖
5:	10.5x	↖
Serie		47.8
Total		97.9

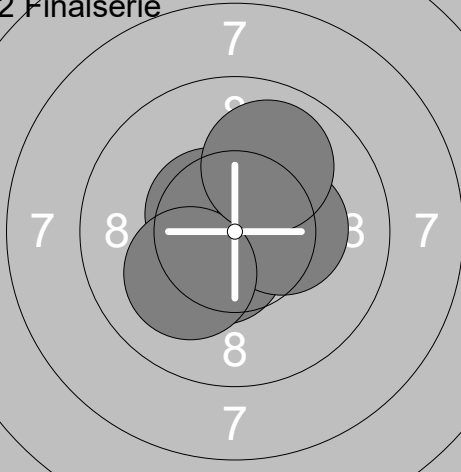
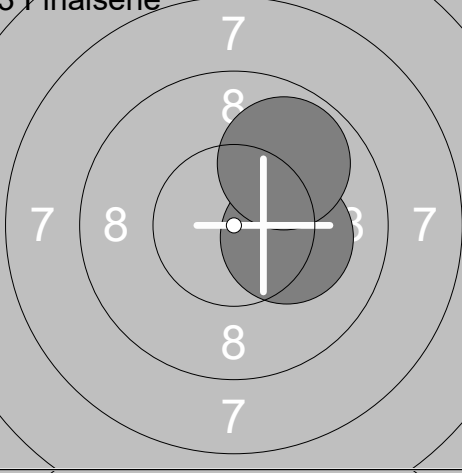
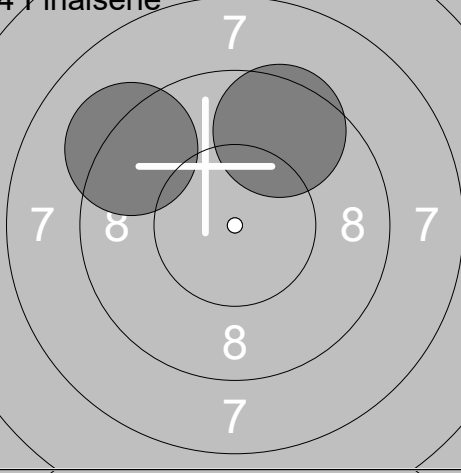
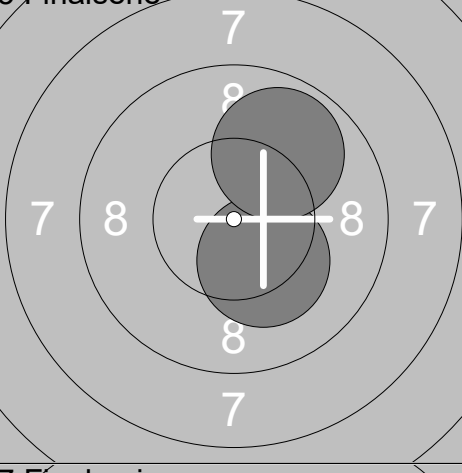
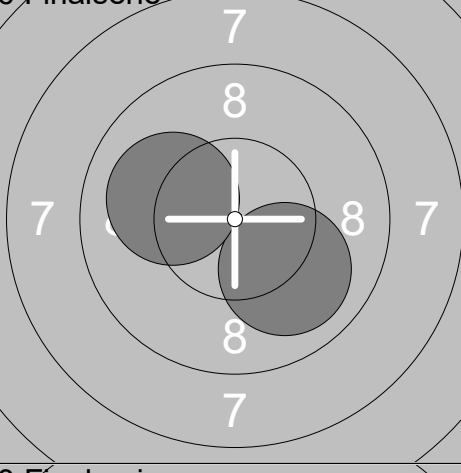
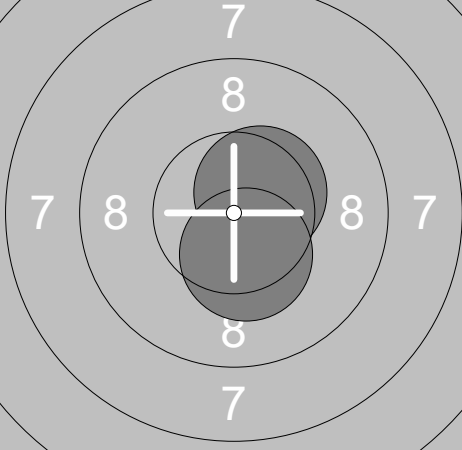
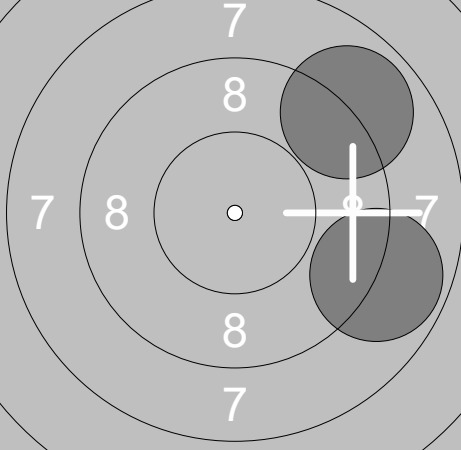

1:	10.2x	←
2:	8.8	←
Serie		19.0
Total		116.9

<p>1 Finalserie</p>  <table border="1" style="width:100%; border-collapse: collapse;"> <tr> <td>1:</td><td>10.1</td><td>↗</td></tr> <tr> <td>2:</td><td>10.3x</td><td>↘</td></tr> <tr> <td>3:</td><td>10.3x</td><td>↘</td></tr> <tr> <td>4:</td><td>10.3x</td><td>↘</td></tr> <tr> <td>5:</td><td>10.6x</td><td>↙</td></tr> <tr> <td colspan="2">Serie</td><td style="text-align: right;">51.6</td></tr> <tr> <td colspan="2">Total</td><td style="text-align: right;">51.6</td></tr> </table>	1:	10.1	↗	2:	10.3x	↘	3:	10.3x	↘	4:	10.3x	↘	5:	10.6x	↙	Serie		51.6	Total		51.6	<p>2 Finalserie</p>  <table border="1" style="width:100%; border-collapse: collapse;"> <tr> <td>1:</td><td>10.6x</td><td>↙</td></tr> <tr> <td>2:</td><td>10.6x</td><td>↖</td></tr> <tr> <td>3:</td><td>10.3x</td><td>→</td></tr> <tr> <td>4:</td><td>10.1</td><td>↙</td></tr> <tr> <td>5:</td><td>10.0</td><td>↗</td></tr> <tr> <td colspan="2">Serie</td><td style="text-align: right;">51.6</td></tr> <tr> <td colspan="2">Total</td><td style="text-align: right;">103.2</td></tr> </table>	1:	10.6x	↙	2:	10.6x	↖	3:	10.3x	→	4:	10.1	↙	5:	10.0	↗	Serie		51.6	Total		103.2
1:	10.1	↗																																									
2:	10.3x	↘																																									
3:	10.3x	↘																																									
4:	10.3x	↘																																									
5:	10.6x	↙																																									
Serie		51.6																																									
Total		51.6																																									
1:	10.6x	↙																																									
2:	10.6x	↖																																									
3:	10.3x	→																																									
4:	10.1	↙																																									
5:	10.0	↗																																									
Serie		51.6																																									
Total		103.2																																									
<p>3 Finalserie</p>  <table border="1" style="width:100%; border-collapse: collapse;"> <tr> <td>1:</td><td>10.2x</td><td>→</td></tr> <tr> <td>2:</td><td>9.9</td><td>↗</td></tr> <tr> <td colspan="2">Serie</td><td style="text-align: right;">20.1</td></tr> <tr> <td colspan="2">Total</td><td style="text-align: right;">123.3</td></tr> </table>	1:	10.2x	→	2:	9.9	↗	Serie		20.1	Total		123.3	<p>4 Finalserie</p>  <table border="1" style="width:100%; border-collapse: collapse;"> <tr> <td>1:</td><td>9.2</td><td>↖</td></tr> <tr> <td>2:</td><td>9.5</td><td>↗</td></tr> <tr> <td colspan="2">Serie</td><td style="text-align: right;">18.7</td></tr> <tr> <td colspan="2">Total</td><td style="text-align: right;">142.0</td></tr> </table>	1:	9.2	↖	2:	9.5	↗	Serie		18.7	Total		142.0																		
1:	10.2x	→																																									
2:	9.9	↗																																									
Serie		20.1																																									
Total		123.3																																									
1:	9.2	↖																																									
2:	9.5	↗																																									
Serie		18.7																																									
Total		142.0																																									
<p>5 Finalserie</p>  <table border="1" style="width:100%; border-collapse: collapse;"> <tr> <td>1:</td><td>10.3x</td><td>↘</td></tr> <tr> <td>2:</td><td>9.9</td><td>↗</td></tr> <tr> <td colspan="2">Serie</td><td style="text-align: right;">20.2</td></tr> <tr> <td colspan="2">Total</td><td style="text-align: right;">162.2</td></tr> </table>	1:	10.3x	↘	2:	9.9	↗	Serie		20.2	Total		162.2	<p>6 Finalserie</p>  <table border="1" style="width:100%; border-collapse: collapse;"> <tr> <td>1:</td><td>10.0</td><td>↘</td></tr> <tr> <td>2:</td><td>10.1</td><td>↖</td></tr> <tr> <td colspan="2">Serie</td><td style="text-align: right;">20.1</td></tr> <tr> <td colspan="2">Total</td><td style="text-align: right;">182.3</td></tr> </table>	1:	10.0	↘	2:	10.1	↖	Serie		20.1	Total		182.3																		
1:	10.3x	↘																																									
2:	9.9	↗																																									
Serie		20.2																																									
Total		162.2																																									
1:	10.0	↘																																									
2:	10.1	↖																																									
Serie		20.1																																									
Total		182.3																																									
<p>7 Finalserie</p>  <table border="1" style="width:100%; border-collapse: collapse;"> <tr> <td>1:</td><td>10.5x</td><td>↗</td></tr> <tr> <td>2:</td><td>10.4x</td><td>↘</td></tr> <tr> <td colspan="2">Serie</td><td style="text-align: right;">20.9</td></tr> <tr> <td colspan="2">Total</td><td style="text-align: right;">203.2</td></tr> </table>	1:	10.5x	↗	2:	10.4x	↘	Serie		20.9	Total		203.2	<p>8 Finalserie</p>  <table border="1" style="width:100%; border-collapse: collapse;"> <tr> <td>1:</td><td>8.9</td><td>↗</td></tr> <tr> <td>2:</td><td>8.9</td><td>→</td></tr> <tr> <td colspan="2">Serie</td><td style="text-align: right;">17.8</td></tr> <tr> <td colspan="2">Total</td><td style="text-align: right;">221.0</td></tr> </table>	1:	8.9	↗	2:	8.9	→	Serie		17.8	Total		221.0																		
1:	10.5x	↗																																									
2:	10.4x	↘																																									
Serie		20.9																																									
Total		203.2																																									
1:	8.9	↗																																									
2:	8.9	→																																									
Serie		17.8																																									
Total		221.0																																									

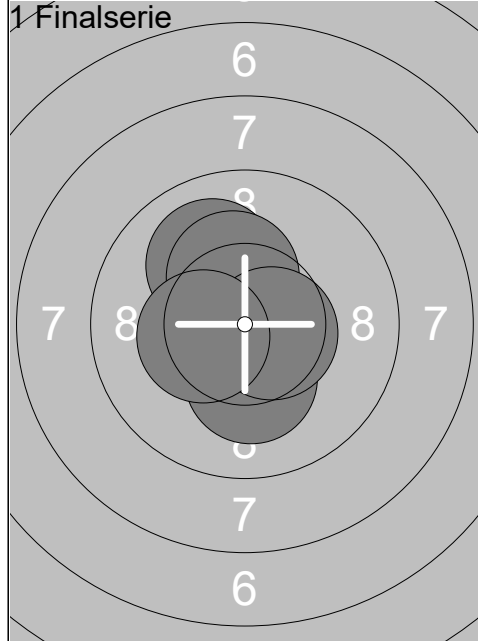

1:	10.2x	↓
2:	10.0	↖
3:	10.3x	↗
4:	10.6x	→
5:	10.4x	←
<hr/>		
Serie	51.5	
Total	51.5	

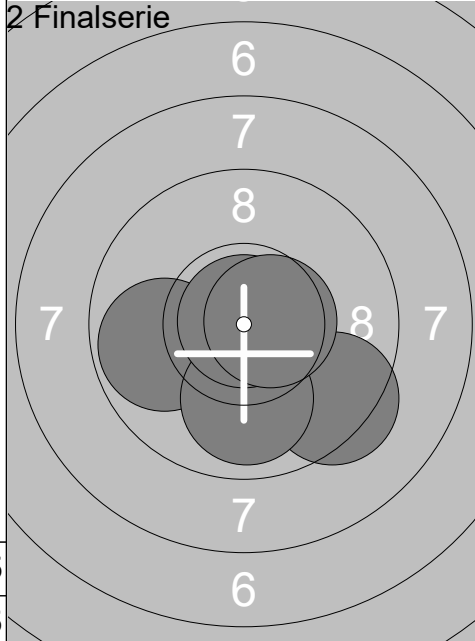

1:	9.4	↘
2:	9.8	←
3:	9.9	↓
4:	10.9x	↑
5:	10.6x	→
<hr/>		
Serie	50.6	
Total	102.1	

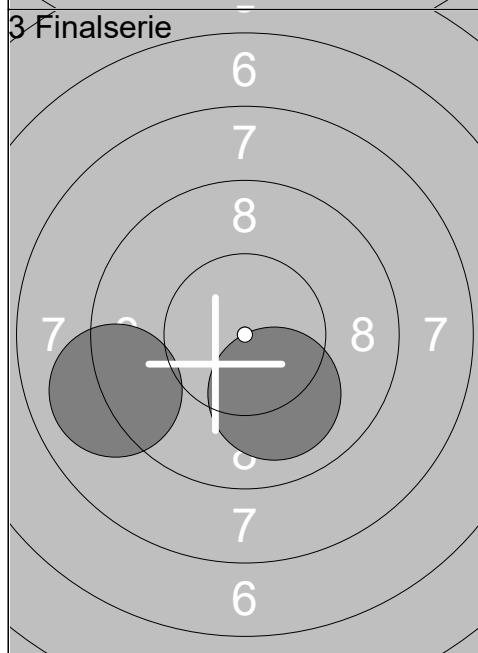

1:	10.1	↘
2:	9.0	←
<hr/>		
Serie	19.1	
Total	121.2	

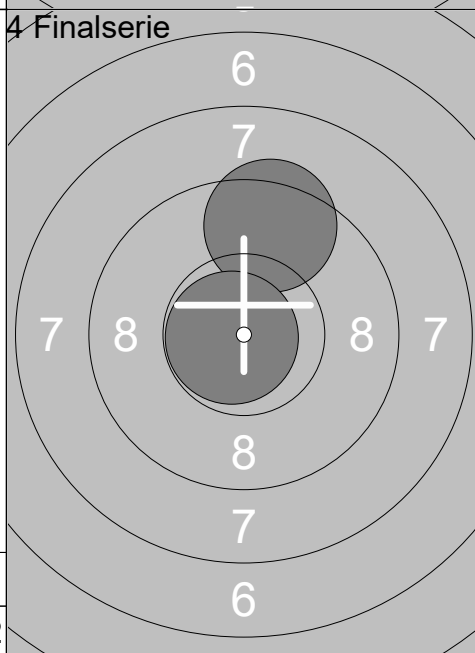

1:	9.4	↑
2:	10.8x	←
<hr/>		
Serie	20.2	
Total	141.4	

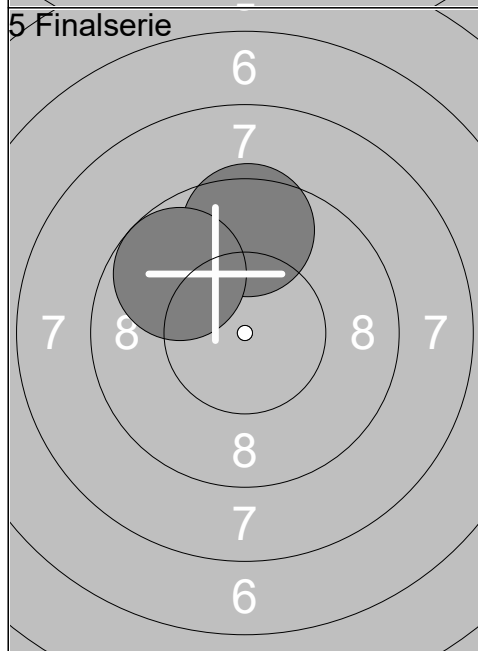

1:	9.5	↑
2:	9.8	↖
<hr/>		
Serie	19.3	
Total	160.7	

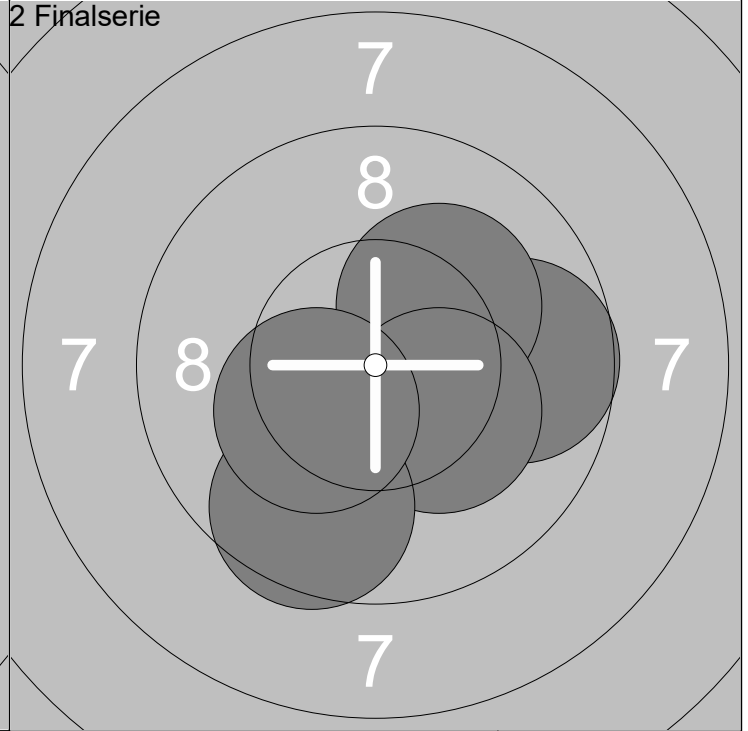
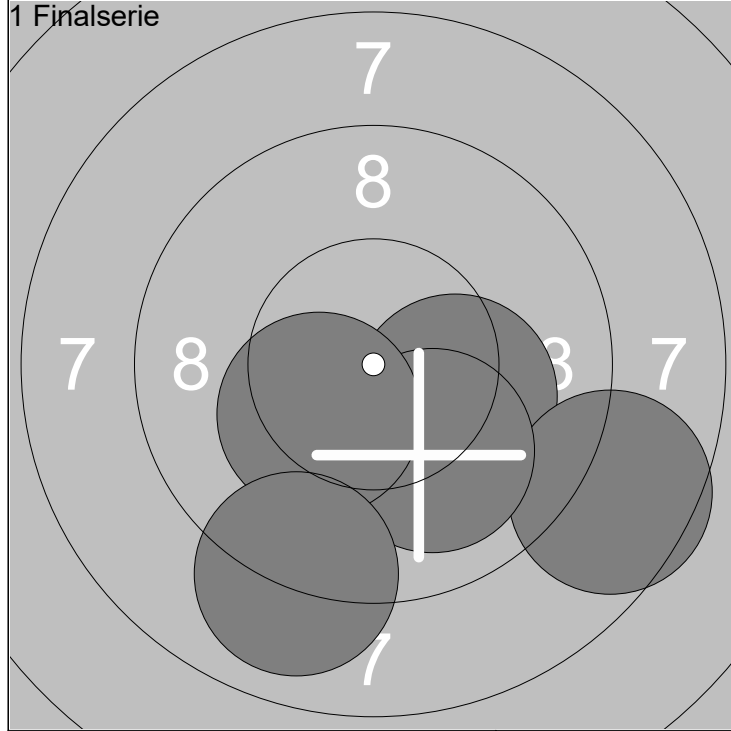

1: 10.2x →		Serie	48.1
2: 8.6 →		Total	48.1
3: 10.0 ↓			
4: 10.3x ↙			
5: 9.0 ↓			

1: 9.7 →		Serie	50.1
2: 10.2x ↗		Total	98.2
3: 10.3x →			
4: 9.6 ↓			
5: 10.3x ↙			

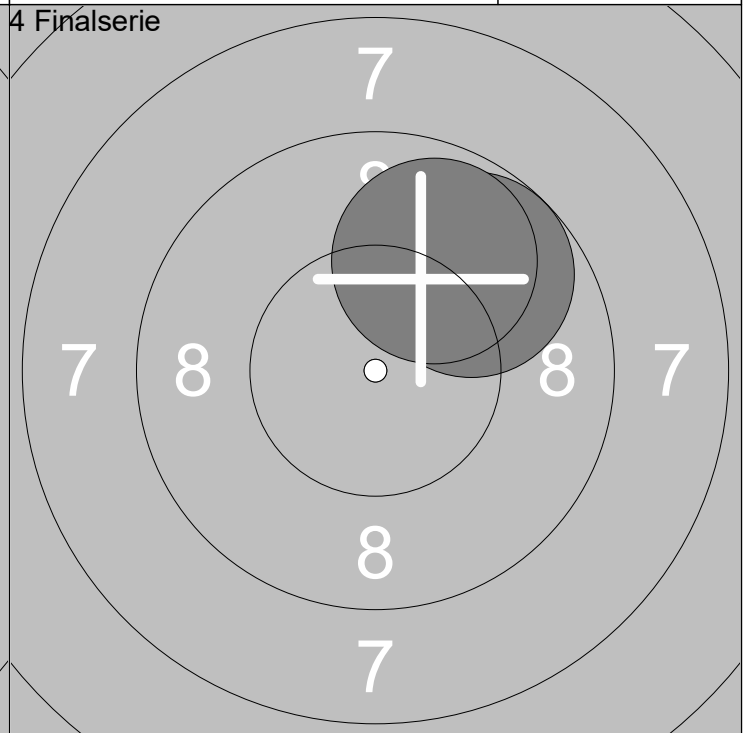
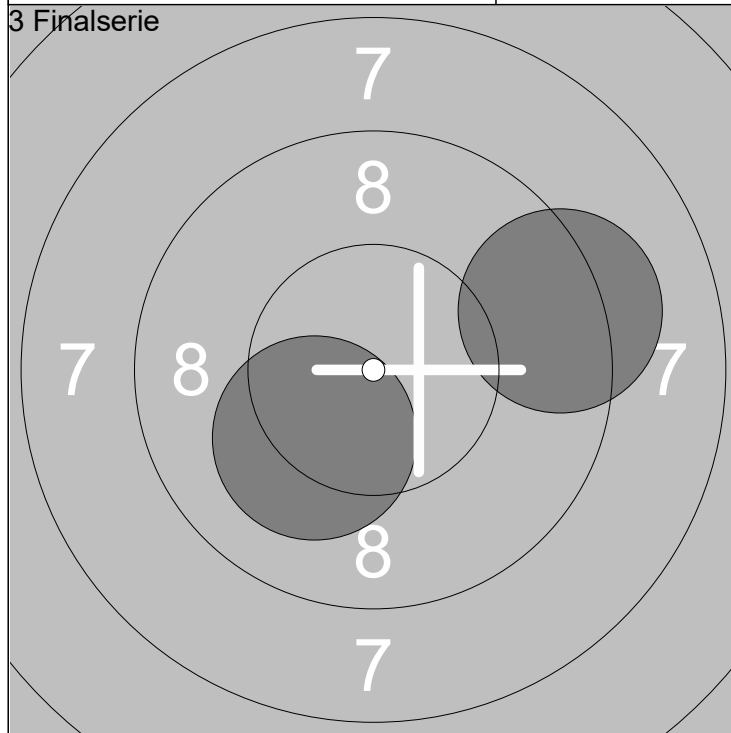

1: 10.2x ↙		Serie	19.4
2: 9.2 →		Total	117.6

1: 9.8 ↗		Serie	19.7
2: 9.9 ↗		Total	137.3

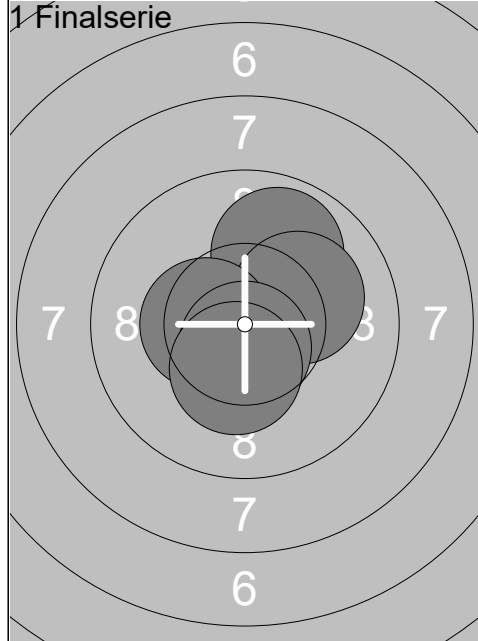

1:	9.9	↗
2:	10.1	↘
3:	10.4x	←
4:	10.6x	↓
5:	10.3x	↓
<hr/>		
Serie	51.3	
Total	51.3	

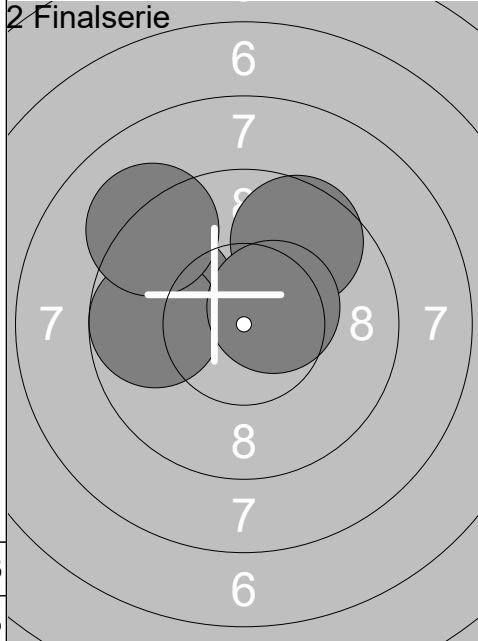

1:	9.9	↖
2:	9.6	↗
3:	9.8	←
4:	10.5x	↘
5:	9.2	↖
<hr/>		
Serie	49.0	
Total	100.3	

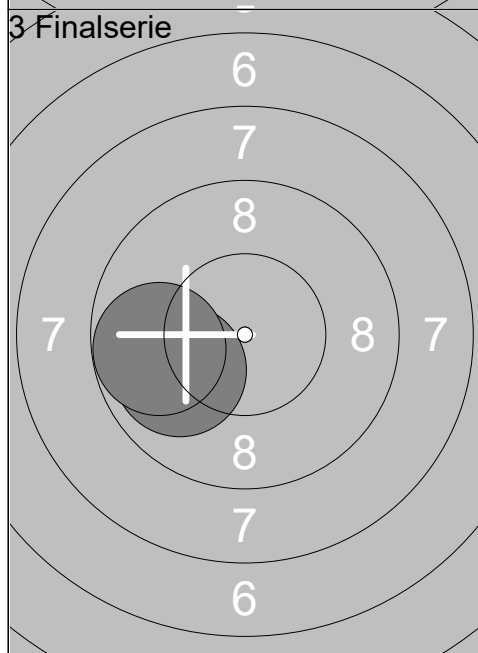

1:	9.9	↖
2:	9.8	←
<hr/>		
Serie	19.7	
Total	120.0	

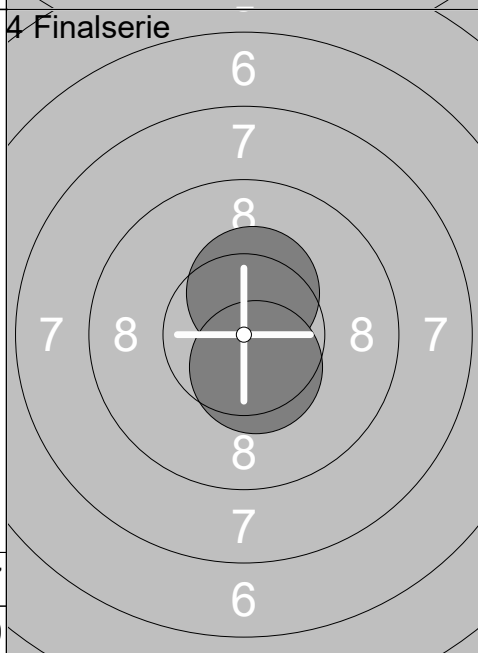

1:	10.4x	↗
2:	10.5x	↓
<hr/>		
Serie	20.9	
Total	140.9	

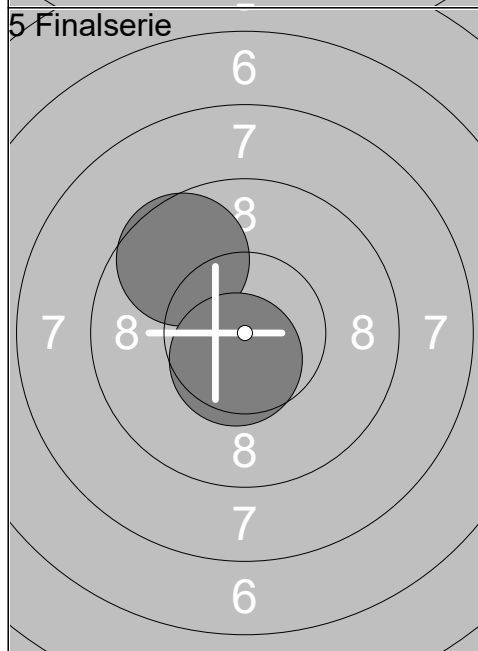

1:	9.6	↖
2:	10.6x	↓
<hr/>		
Serie	20.2	
Total	161.1	

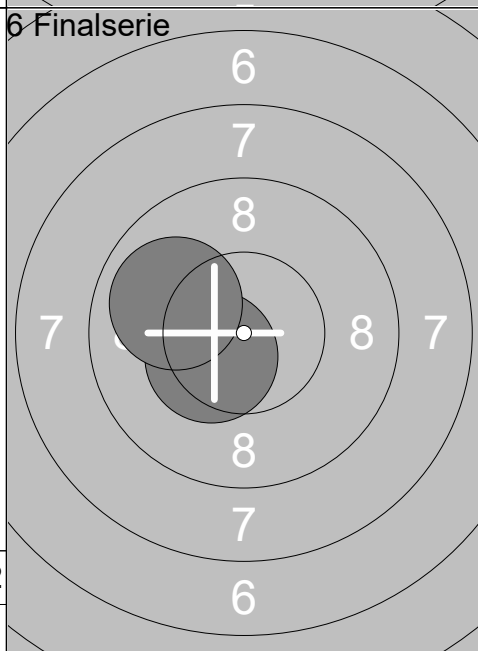

1:	10.4x	↙
2:	10.0	↖
<hr/>		
Serie	20.4	
Total	181.5	