

1: 10.0 →	6: 10.8x ↑	Serie	95
2: 10.3x →	7: 10.1 ↓		
3: 8.7 ←	8: 8.9 ↙	Total	95
4: 10.0 ↗	9: 10.2x ↓		
5: 10.6x →	10: 9.9 ←		

11: 10.7x ↓	16: 10.7x ↑	Serie	94
12: 9.9 ←	17: 9.4 →		
13: 9.9 ↙	18: 10.4x ↓	Total	189
14: 10.6x ←	19: 9.9 ↗		
15: 10.1 →	20: 8.9 →		

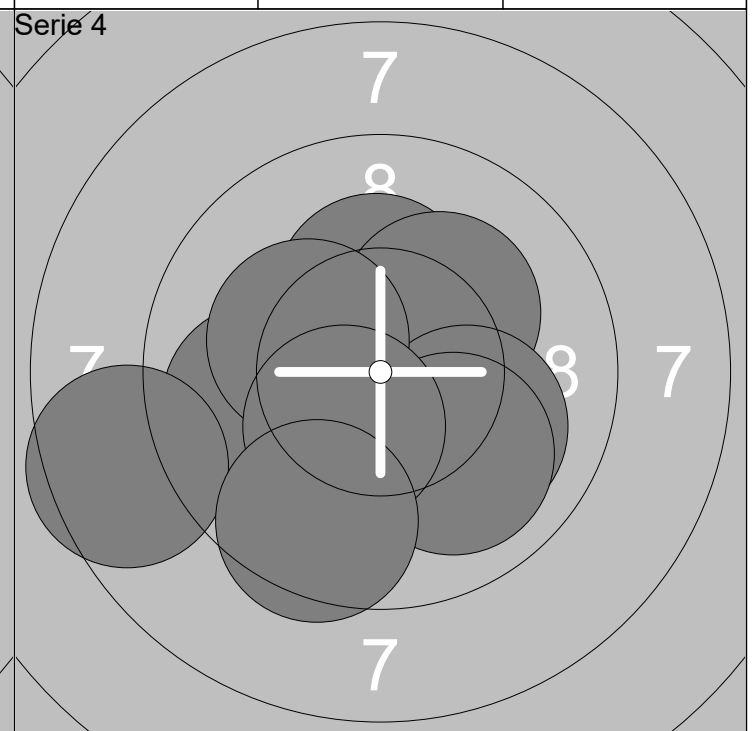
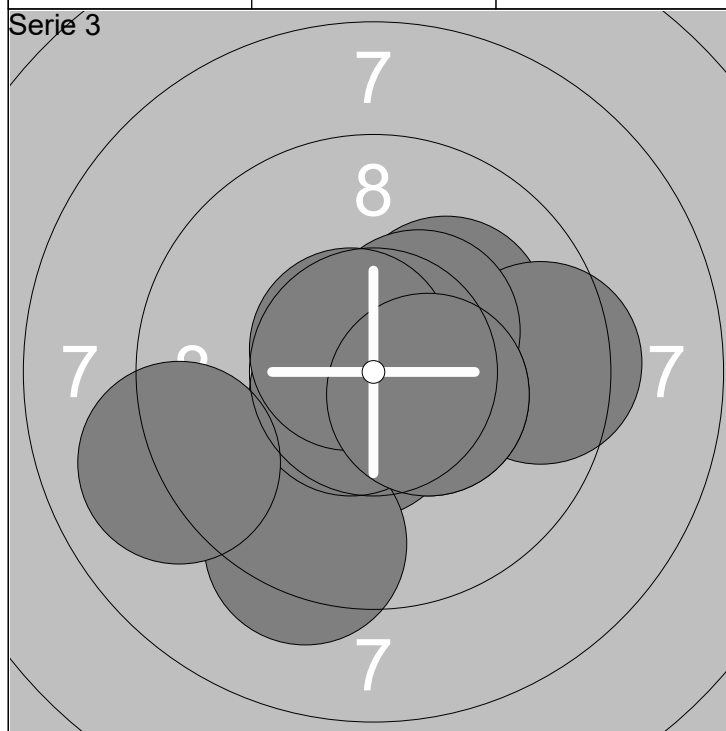

21: 10.1 ↗	26: 9.3 ↓	Serie	97
22: 9.5 →	27: 10.7x ↙		
23: 10.4x →	28: 10.7x ↖	Total	286
24: 10.4x ↗	29: 9.0 ←		
25: 10.5x ↓	30: 10.4x →		

31: 9.9 ←	36: 10.0 ↘	Serie	96
32: 10.3x ↑	37: 10.0 ↓		
33: 10.7x ↓	38: 10.2x ↖	Total	382
34: 8.5 ←	39: 10.4x ↘		
35: 10.2x ↗	40: 9.5 ↓		

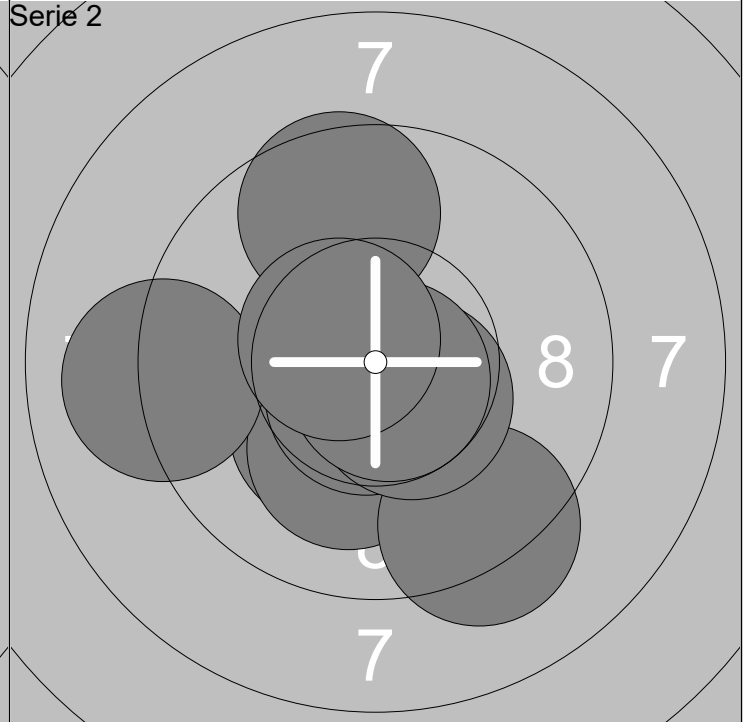
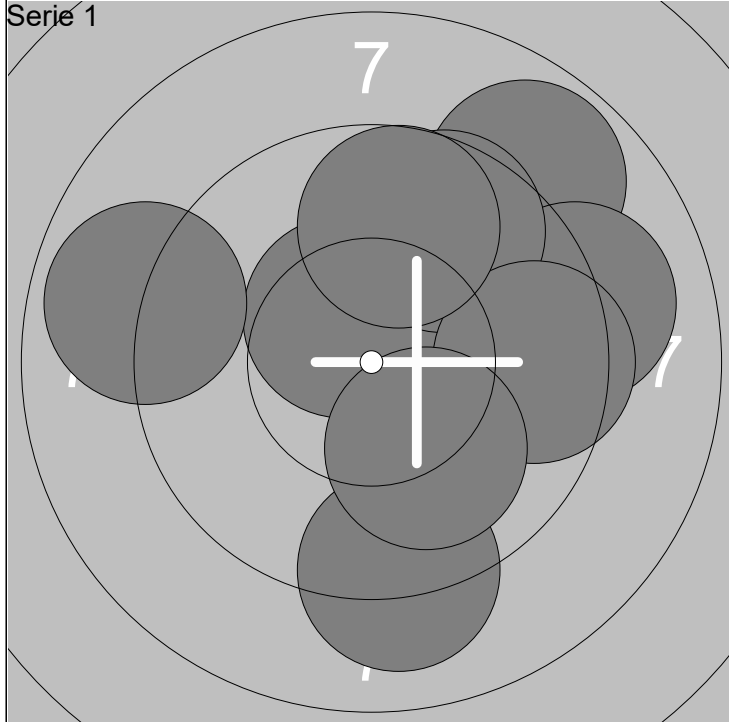

1: 10.6x ↗	6: 9.1 ↓	Serie	91
2: 10.5x ↖	7: 9.5 →		
3: 8.9 ↗	8: 10.0 ↓	Total	91
4: 9.1 →	9: 8.9 ←		
5: 9.6 ↗	10: 9.7 ↑		

11: 10.2x ↙	16: 10.7x ↓	Serie	97
12: 10.4x ↓	17: 10.5x ↓		
13: 10.2x ↓	18: 10.7x ↓	Total	188
14: 9.1 ←	19: 9.6 ↑		
15: 9.2 ↓	20: 10.6x ↖		

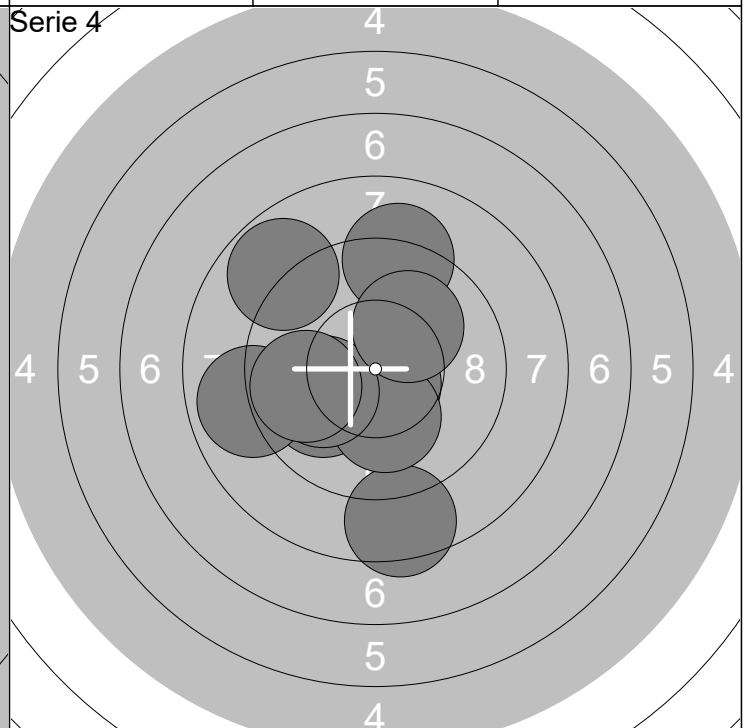
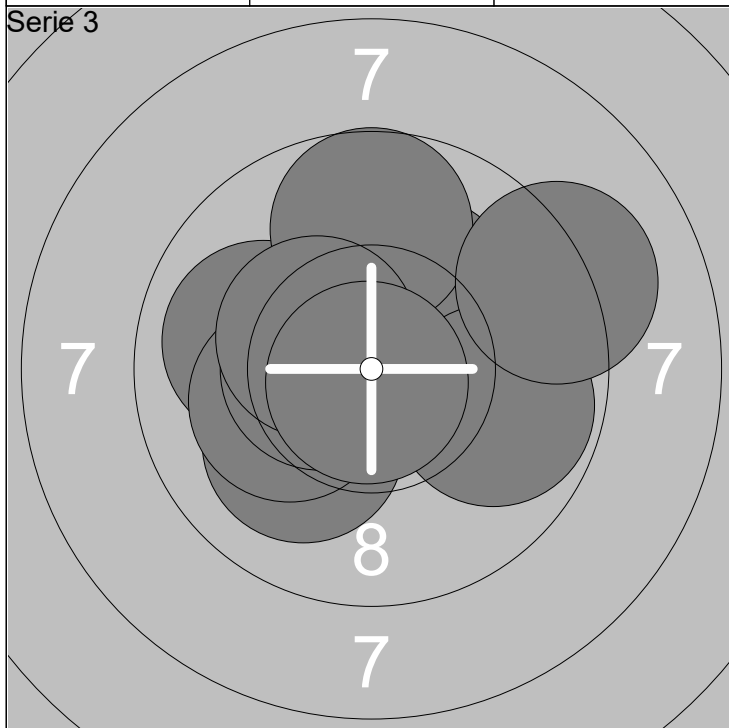

21: 10.2x ↗	26: 10.5x ←	Serie	97
22: 10.0 ←	27: 9.7 ↑		
23: 10.1 ↙	28: 10.4x ↖	Total	285
24: 9.8 →	29: 10.8x ↓		
25: 10.2x ←	30: 9.2 →		

31: 10.0 ↙	36: 10.2x ↓	Serie	92
32: 10.7x ↓	37: 10.0 ←		
33: 8.5 ↓	38: 9.2 ↑	Total	377
34: 8.8 ↗	39: 9.8 ←		
35: 8.9 ←	40: 10.1 ↗		

Rottne Industri Cup 2018

Söraby Skytteförening

Mini

27.10.2018

Rottne Industri Cup 2018

Söraby SKF

Serie 1

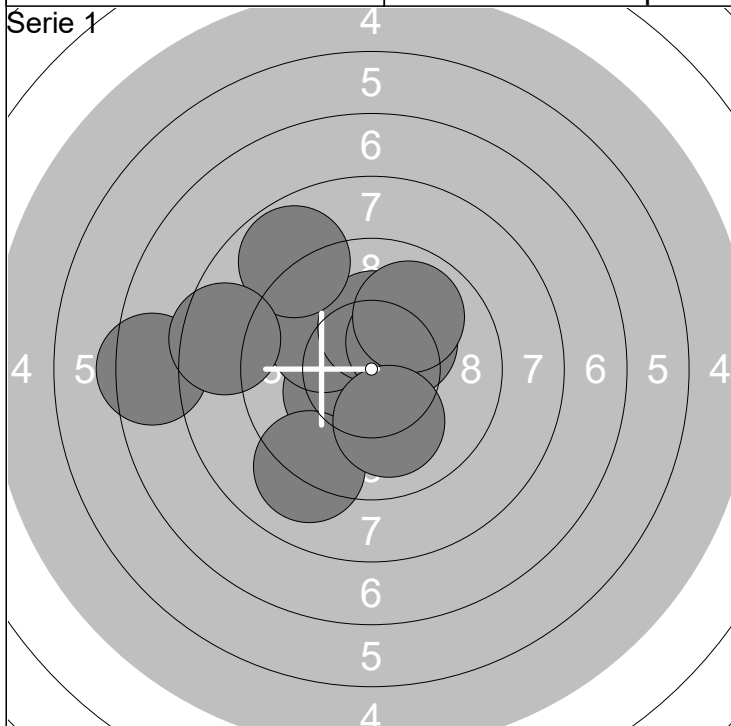

Serie 2

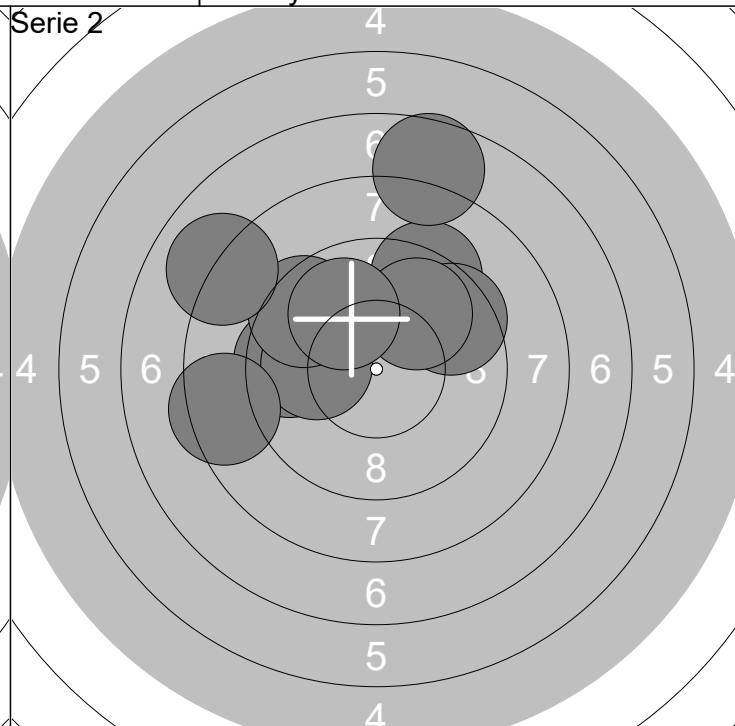

1: 10.3x ↙

6: 10.3x ↗

2: 9.1 ↘

7: 9.9 ↗

3: 10.0 ↖

8: 8.8 ↖

4: 7.4 ←

9: 8.6 ←

5: 10.3x ↑

10: 10.1 ↓

Serie 91

Total 91

11: 9.3 ↗

16: 9.9 ↗

12: 7.6 ↑

17: 9.5 ↖

13: 9.5 ←

18: 8.0 ↗

14: 10.0 ←

19: 9.9 ↗

15: 9.5 ↗

20: 8.4 ←

Serie 87

Total 178

Serie 3

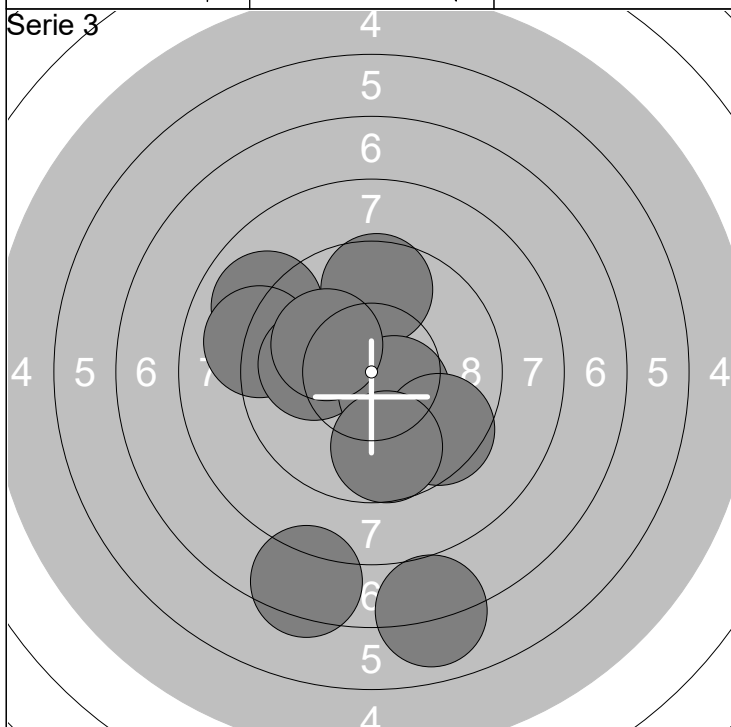

Serie 4

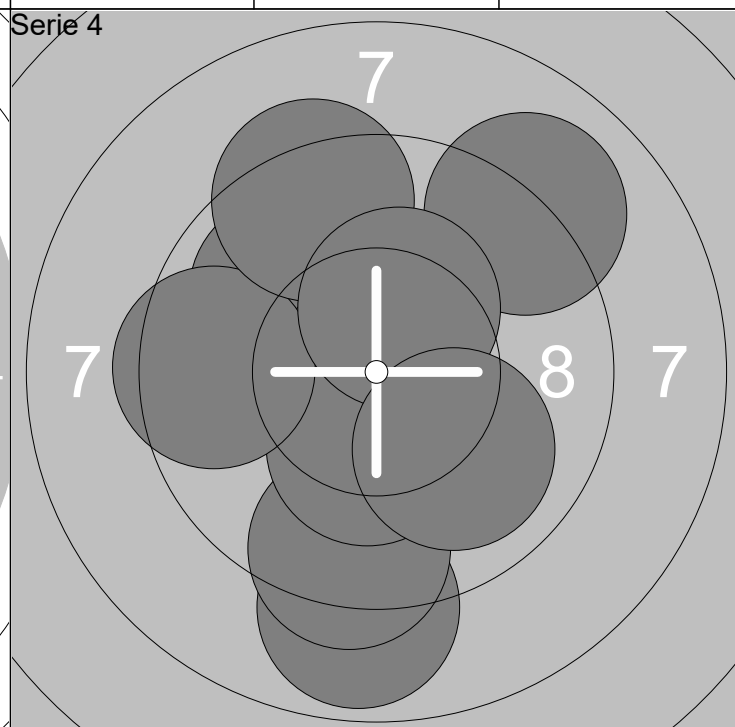

21: 9.6 ↑

26: 10.1 ↖

22: 9.0 ↖

27: 9.5 ↘

23: 9.1 ←

28: 7.4 ↓

24: 10.0 ←

29: 7.0 ↓

25: 10.5x ↘

30: 9.7 ↓

Serie 89

Total 267

31: 8.9 ↓

36: 10.3x ↓

32: 9.4 ↓

37: 9.5 ←

33: 9.0 ↗

38: 9.3 ↑

34: 9.9 ↖

39: 10.3x ↑

35: 10.8x ↙

40: 10.0 ↘

Serie 93

Total 360

Rottne Industri Cup 2018

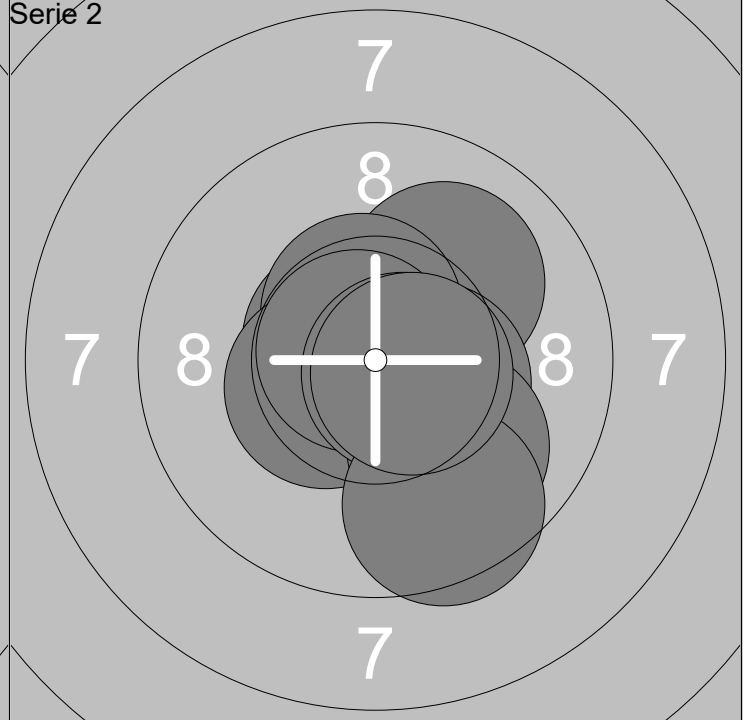
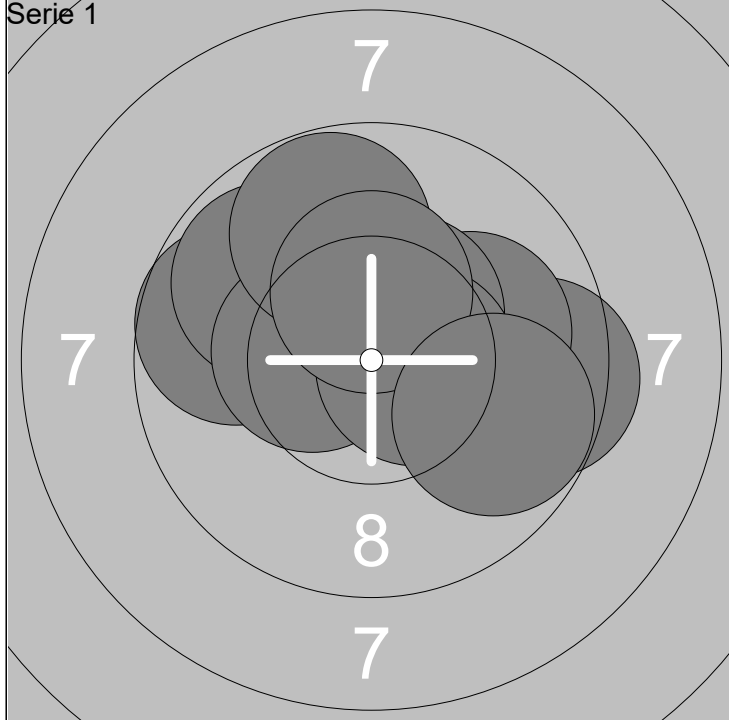

1: 9.5 →	6: 9.8 ↑	Serie	95
2: 10.0 →	7: 10.5x ↗		
3: 9.7 ←	8: 10.5x →	Total	95
4: 9.8 ↗	9: 10.4x ↑		
5: 10.4x ←	10: 9.8 →		

11: 10.0 ↗	16: 10.8x ↖	Serie	99
12: 10.6x ↖	17: 10.0 ↓		
13: 10.5x ↑	18: 10.7x ↓	Total	194
14: 10.4x ↙	19: 9.5 ↓		
15: 10.4x →	20: 10.6x ↘		

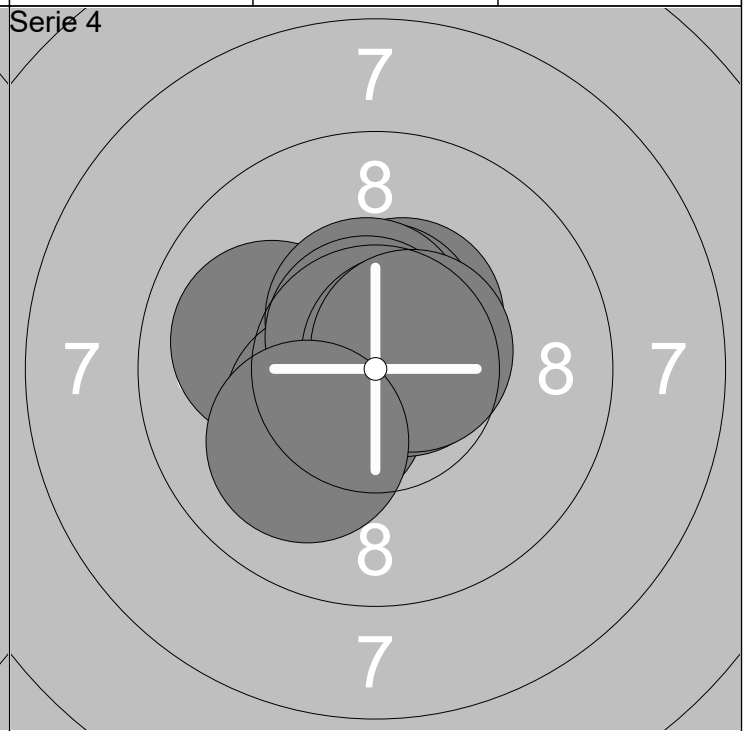
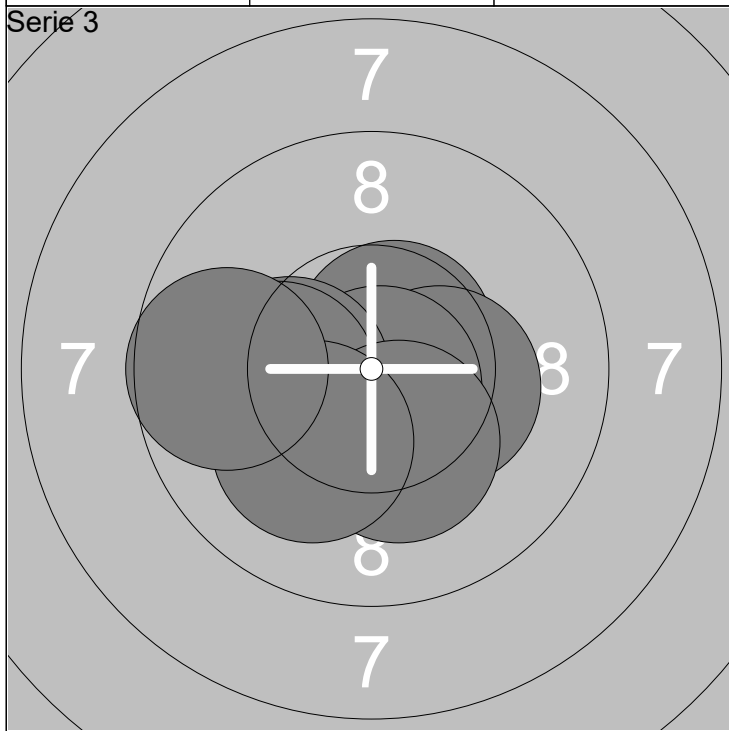

21: 10.5x ↘	26: 10.2x ←	Serie	99
22: 10.6x ↗	27: 10.1 ←		
23: 10.3x ↙	28: 10.3x ↓	Total	293
24: 10.3x →	29: 10.1 ↘		
25: 10.8x ↘	30: 9.7 ←		

31: 10.5x ↗	36: 10.4x ↙	Serie	100
32: 10.5x ↖	37: 10.6x ↑		
33: 10.6x ↑	38: 10.7x ↗	Total	393
34: 10.0 ←	39: 10.6x ↗		
35: 10.5x ↑	40: 10.1 ↘		

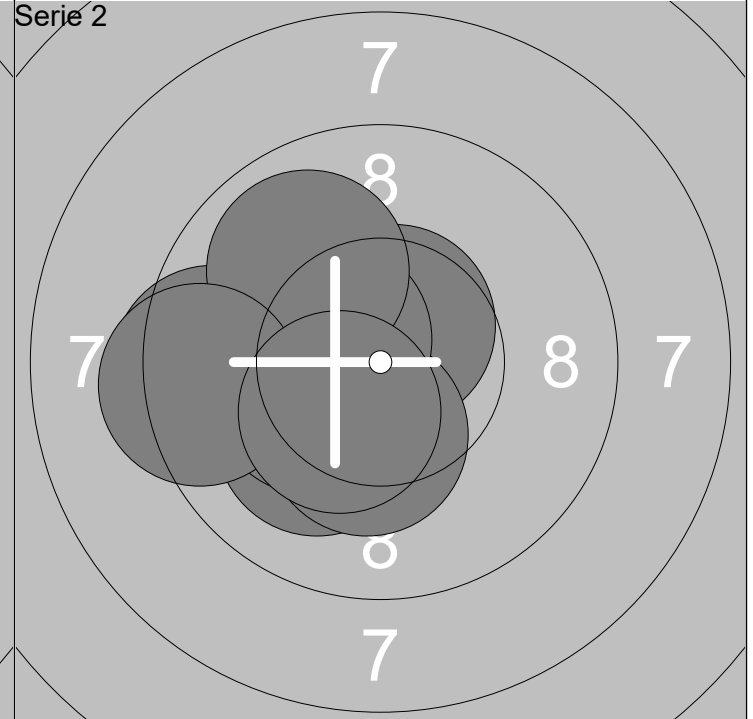
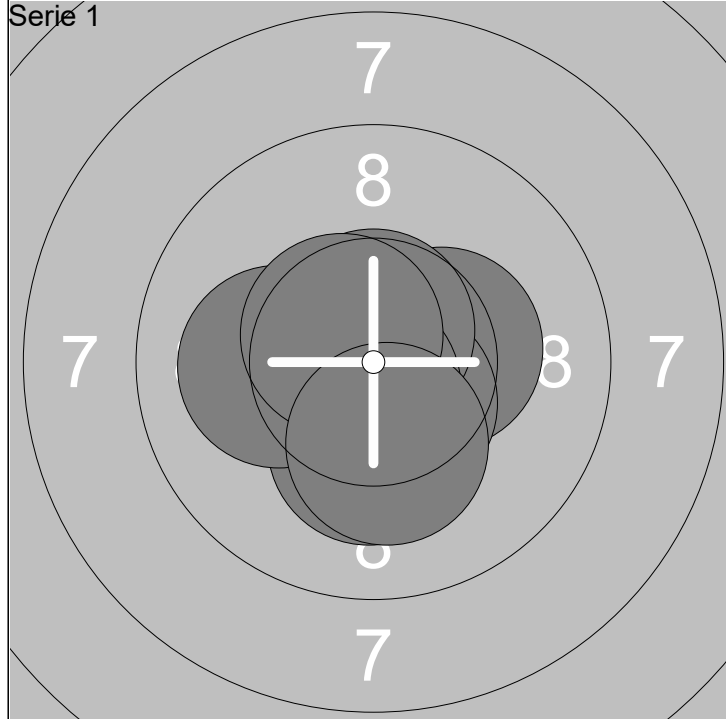

1: 10.2x ↓	6: 10.7x ↑	Serie	100
2: 10.7x ←	7: 10.7x ↓		
3: 10.4x →	8: 10.1 ←	Total	100
4: 10.6x ←	9: 10.6x ↗		
5: 10.5x ↓	10: 10.2x ↓		

11: 9.5 ←	16: 10.5x ↖	Serie	97
12: 10.1 ↙	17: 10.3x ←		
13: 10.4x ↘	18: 9.9 ↗	Total	197
14: 10.6x ↑	19: 9.4 ←		
15: 10.3x ↓	20: 10.4x ↘		

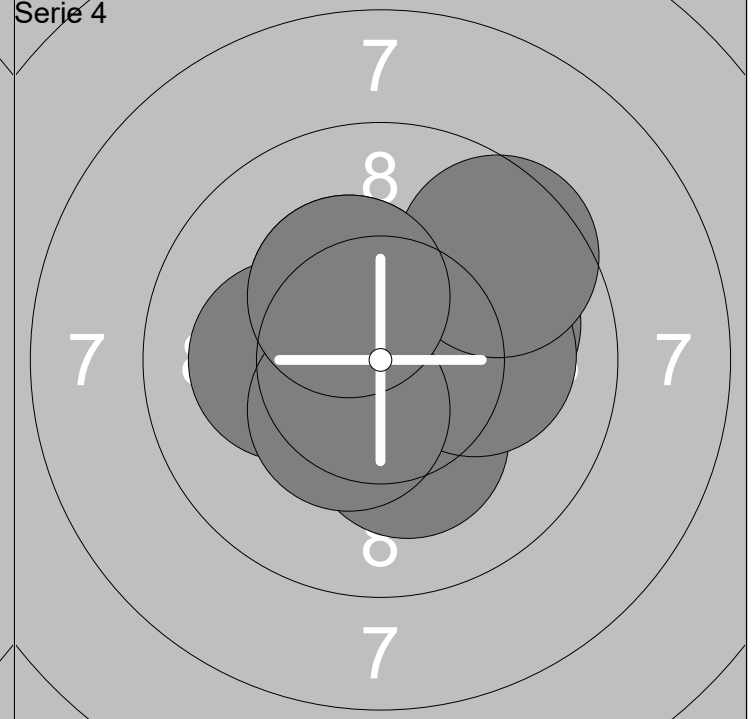
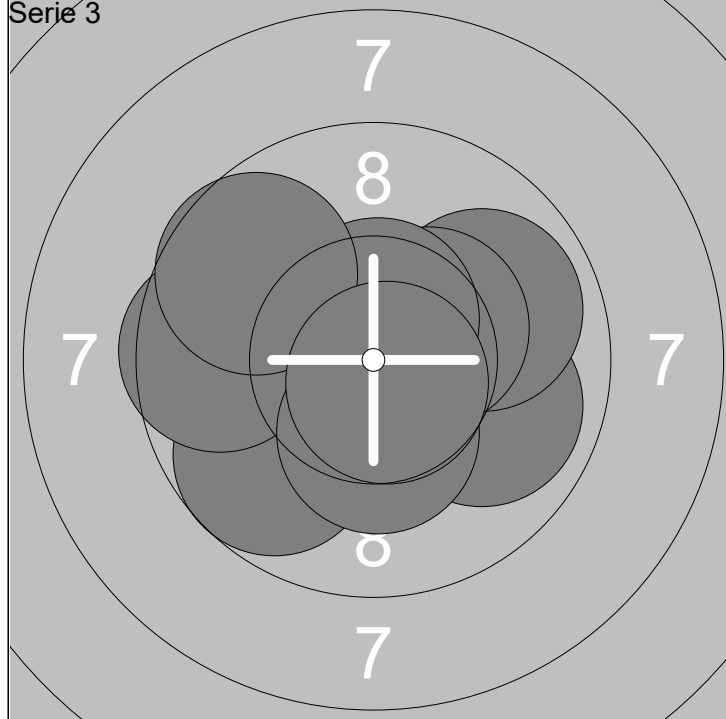

21: 10.7x ←	26: 10.4x ↗	Serie	95
22: 9.9 →	27: 10.6x ↑		
23: 9.7 ↙	28: 10.3x ↓	Total	292
24: 9.6 ←	29: 9.7 ↗		
25: 9.9 →	30: 10.7x ↓		

31: 10.8x →	36: 10.1 →	Serie	99
32: 10.3x ↗	37: 10.1 ←		
33: 10.0 →	38: 10.4x ↘	Total	391
34: 10.8x ↑	39: 9.6 ↗		
35: 10.2x ↓	40: 10.3x ↗		

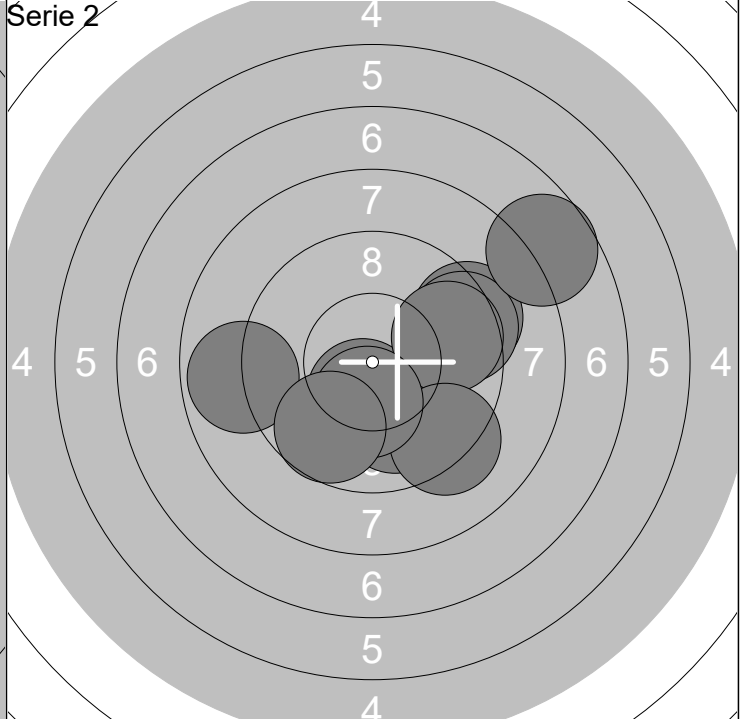
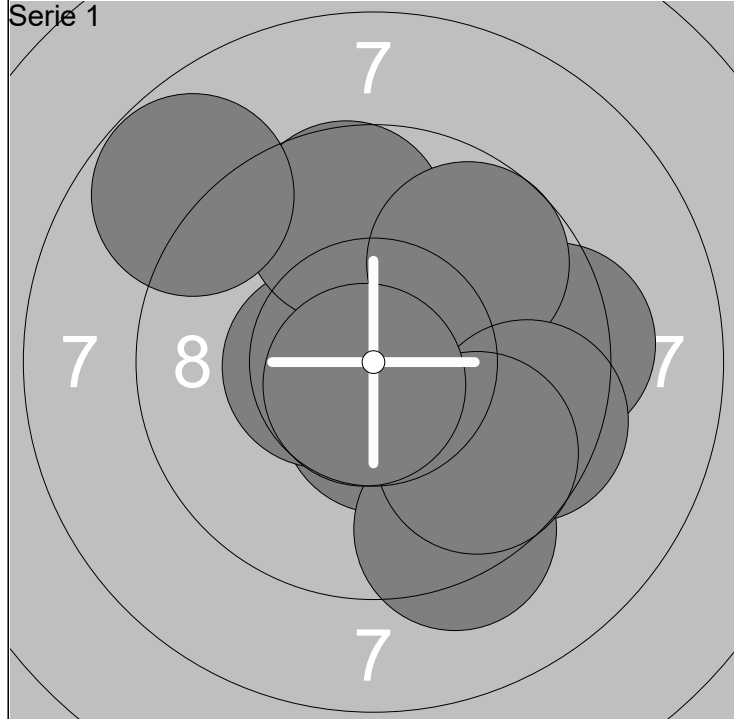

1: 10.5x ↓	6: 9.7 ↗	Serie	92
2: 9.3 ↓	7: 9.5 →		
3: 10.5x ←	8: 9.7 ↓	Total	92
4: 9.7 ↑	9: 10.7x ↓		
5: 9.3 →	10: 8.8 ↖		

11: 10.0 ↓	16: 10.4x ↓	Serie	90
12: 8.9 ←	17: 9.7 →		
13: 9.3 ↗	18: 9.2 ↓	Total	182
14: 9.4 →	19: 10.3x ↓		
15: 7.7 ↗	20: 9.7 ↓		

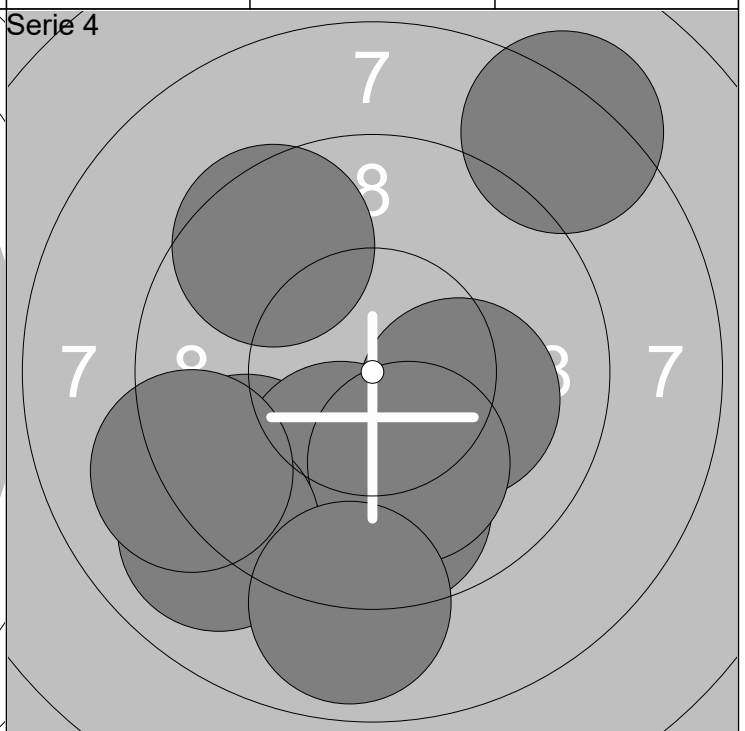
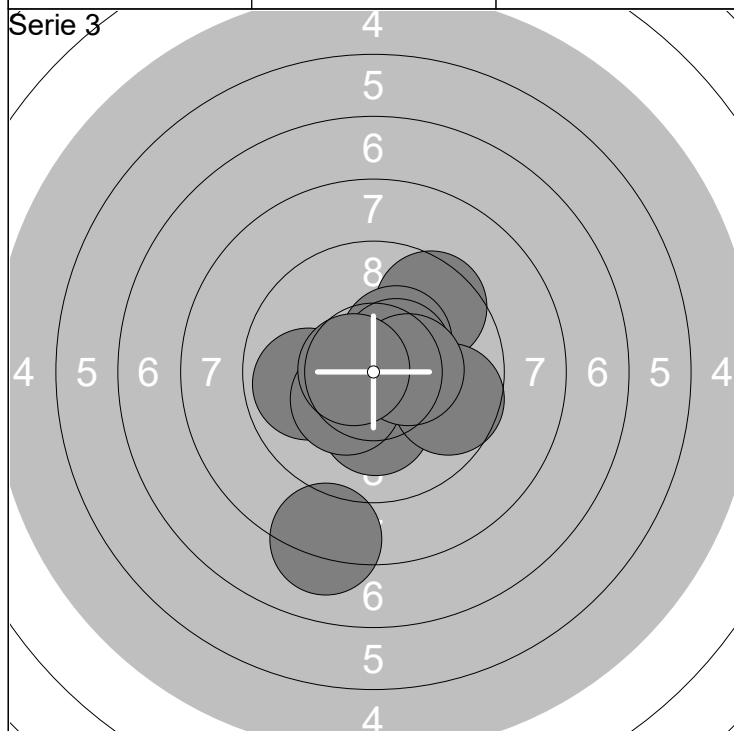

21: 9.9 ←	26: 10.3x ↙	Serie	95
22: 8.2 ↓	27: 9.7 →		
23: 9.6 ↗	28: 10.5x ↗	Total	277
24: 10.4x ↗	29: 10.4x →		
25: 10.2x ↓	30: 10.6x ←		

31: 9.5 ↙	36: 10.1 ↓	Serie	91
32: 8.2 ↗	37: 9.0 ↓		
33: 9.7 ↓	38: 9.1 ←	Total	368
34: 10.1 →	39: 9.5 ↗		
35: 10.1 ↓	40: 8.9 ↓		

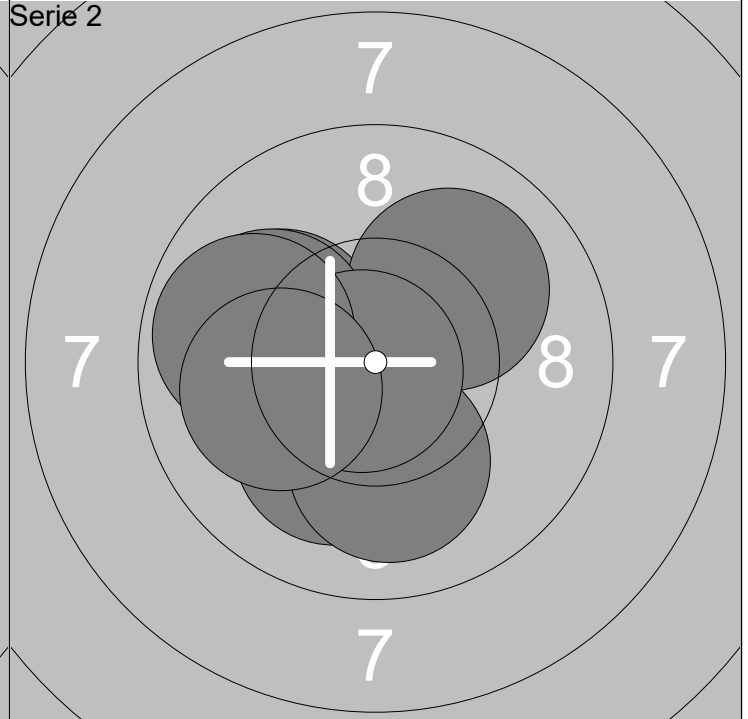
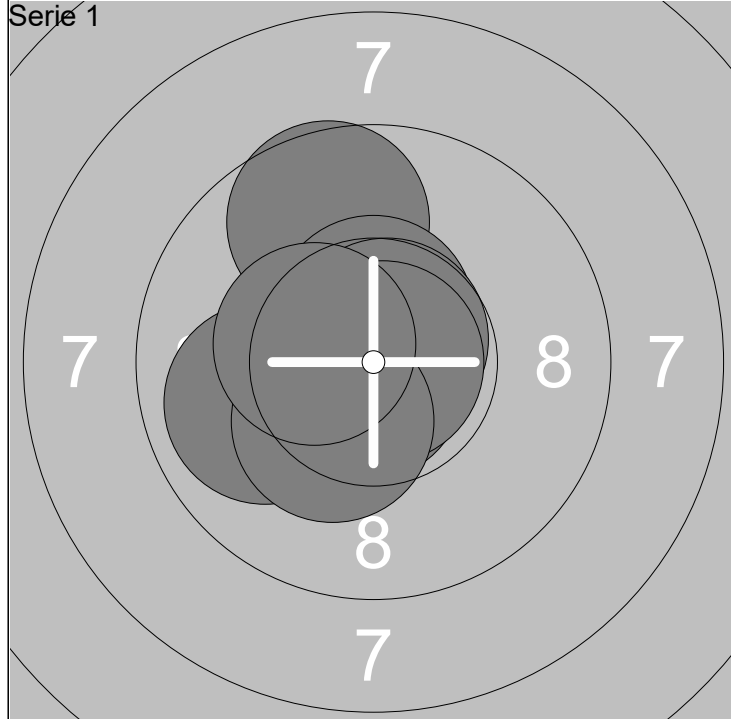

1: 10.7x ↗	6: 10.3x ←	Serie	98
2: 9.6 ↗	7: 10.8x →		
3: 10.5x ↗	8: 9.9 ←	Total	98
4: 10.7x ↗	9: 10.3x ↘		
5: 10.8x ↘	10: 10.4x ←		

11: 10.1 ←	16: 10.5x ↘	Serie	99
12: 10.1 ↗	17: 10.1 ↘		
13: 10.4x ←	18: 10.8x ←	Total	197
14: 10.2x ↘	19: 9.9 ←		
15: 10.0 ←	20: 10.1 ←		

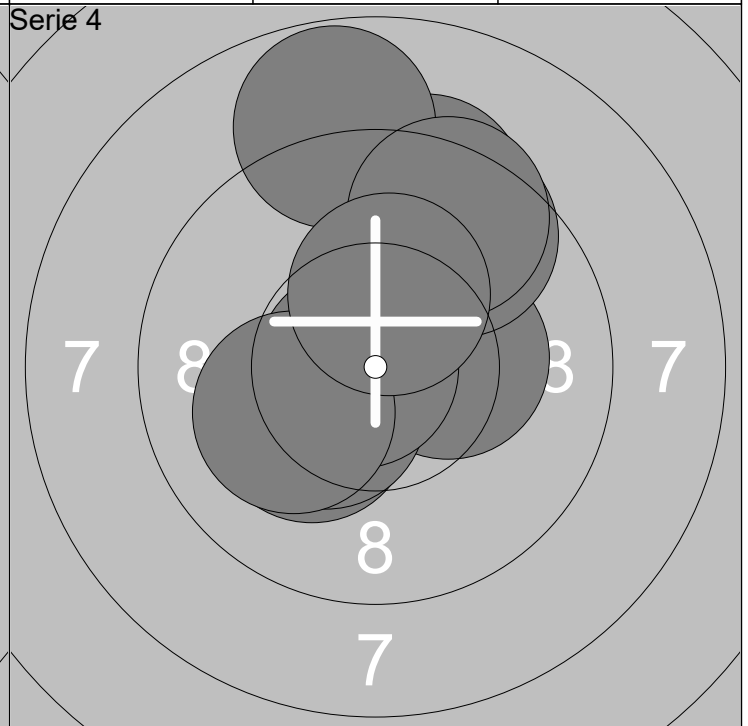
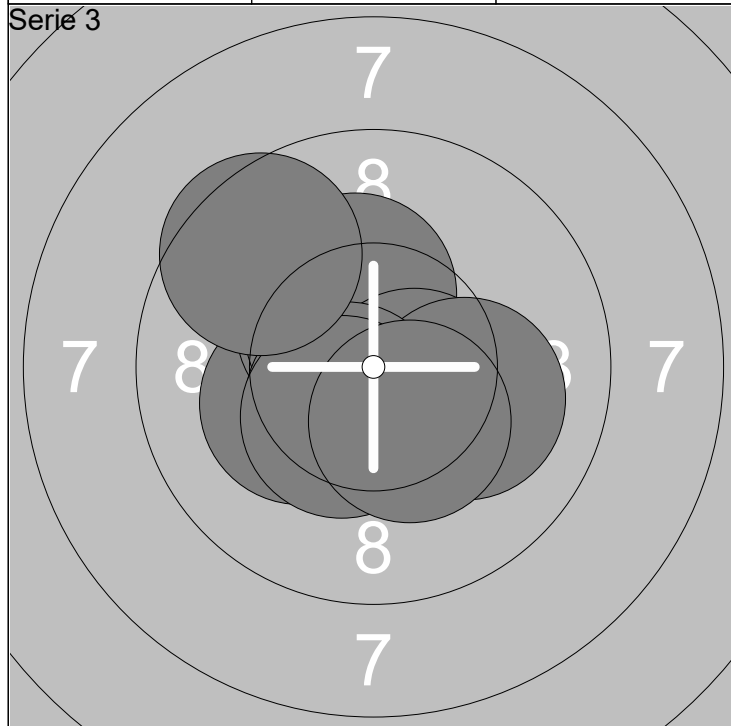

21: 10.2x ←	26: 10.1 →	Serie	99
22: 10.5x ↗	27: 10.5x ↘		
23: 10.5x ↗	28: 10.4x ↘	Total	296
24: 10.3x ↗	29: 10.4x ↘		
25: 10.5x ↘	30: 9.5 ↗		

31: 10.2x ←	36: 10.4x ←	Serie	95
32: 9.4 ↗	37: 10.8x ←		
33: 10.3x →	38: 10.1 ←	Total	391
34: 9.6 ↗	39: 9.5 ↗		
35: 8.8 ↗	40: 10.3x ↗		

Serie 1

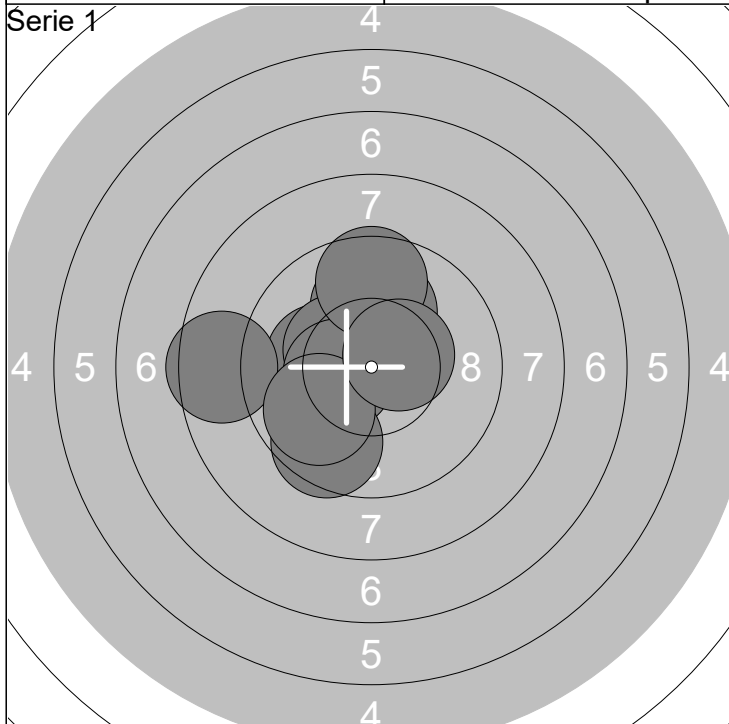

Serie 2

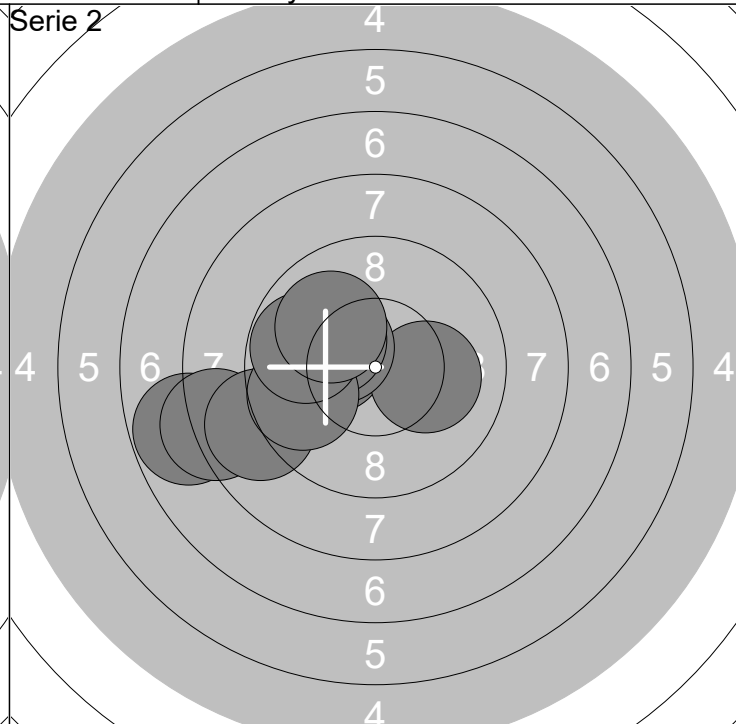

1: 10.0	↑	6: 10.4x	←
2: 10.1	←	7: 9.6	↘
3: 10.0	↑	8: 9.9	←
4: 8.6	←	9: 9.6	↑
5: 10.4x	←	10: 10.5x	↗

Serie	95
Total	95

11: 10.2x	←	16: 10.1	↖
12: 7.8	←	17: 8.9	←
13: 10.1	→	18: 9.7	←
14: 8.2	←	19: 9.8	←
15: 10.3x	←	20: 10.0	↖

Serie	91
Total	186

Serie 3

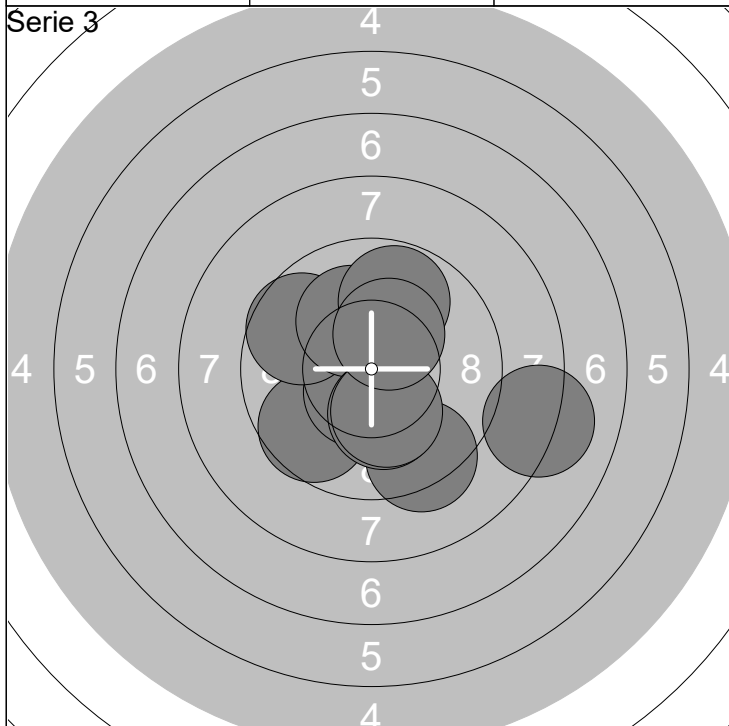

Serie 4

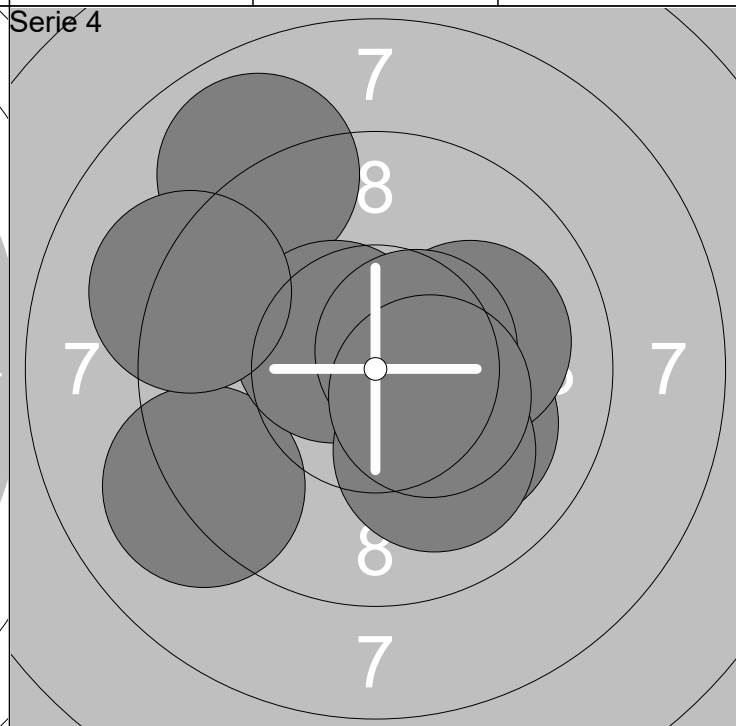

21: 9.6	↙	26: 8.1	→
22: 10.5x	↙	27: 10.2x	↘
23: 9.7	↖	28: 9.8	↑
24: 10.1	↑	29: 10.2x	↘
25: 9.3	↘	30: 10.3x	↗

Serie	94
Total	280

31: 10.1	↘	36: 10.5x	↖
32: 9.1	←	37: 10.0	↘
33: 9.4	↖	38: 10.5x	↗
34: 8.9	↑	39: 10.4x	↘
35: 10.1	→	40: 9.2	↖

Serie	95
Total	375

Serie 1

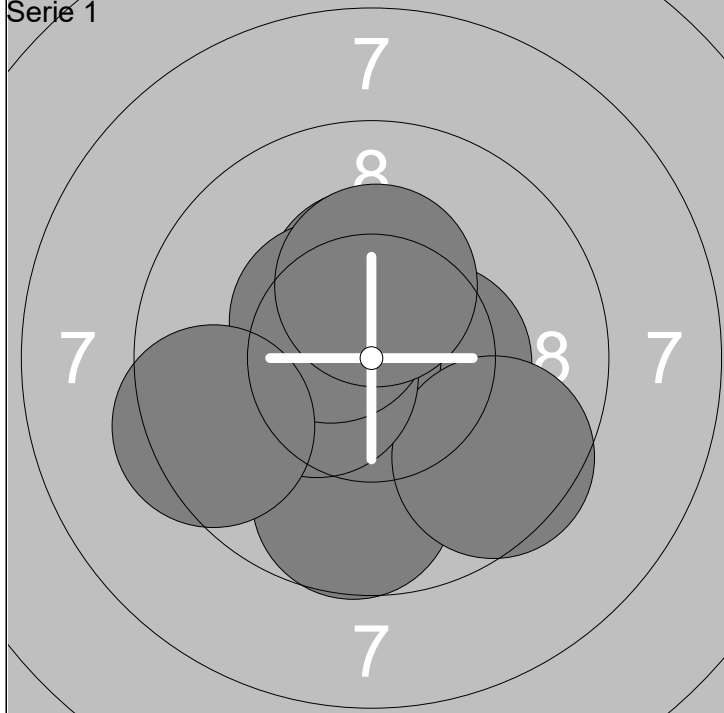

1: 10.7x ←
2: 10.4x →
3: 10.7x ←
4: 10.3x ↑
5: 9.7 ↓

6: 9.5 ↘
7: 10.4x ←
8: 10.5x ↗
9: 10.3x ↑
10: 9.4 ←

Serie 97

Total 97

Serie 2

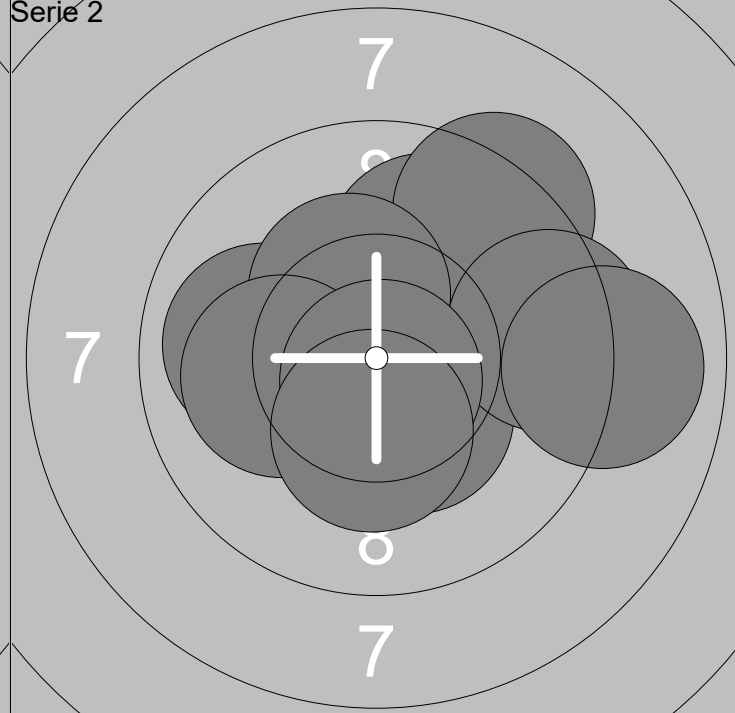

11: 10.0 ←
12: 9.9 ↗
13: 9.3 ↗
14: 10.4x ↘
15: 10.4x ↗

16: 9.4 →
17: 10.1 ←
18: 10.7x ↓
19: 10.3x ↓
20: 9.0 →

Serie 96

Total 193

Serie 3

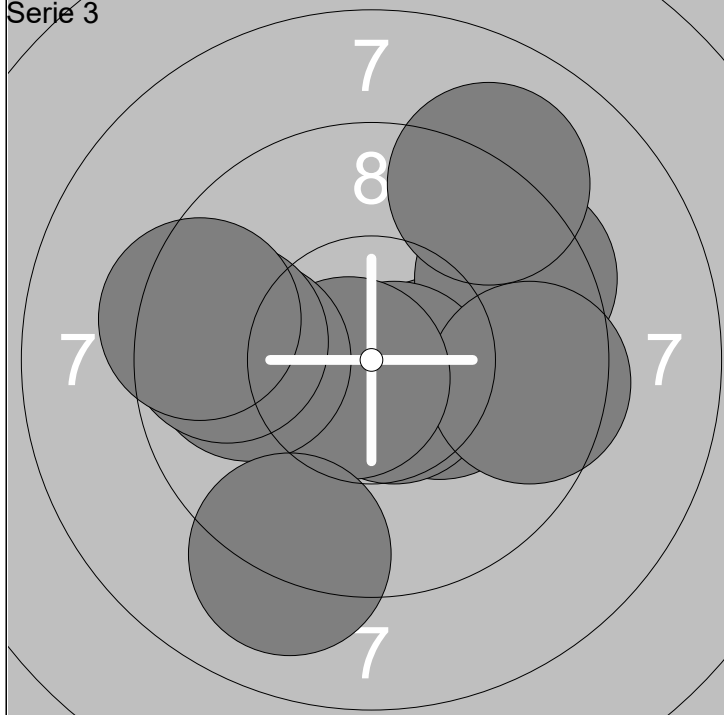

21: 10.3x →
22: 9.5 ↗
23: 10.7x ↘
24: 9.6 →
25: 10.7x ↙

26: 9.9 ←
27: 9.1 ↗
28: 9.1 ↓
29: 9.7 ←
30: 9.4 ←

Serie 93

Total 286

Serie 4

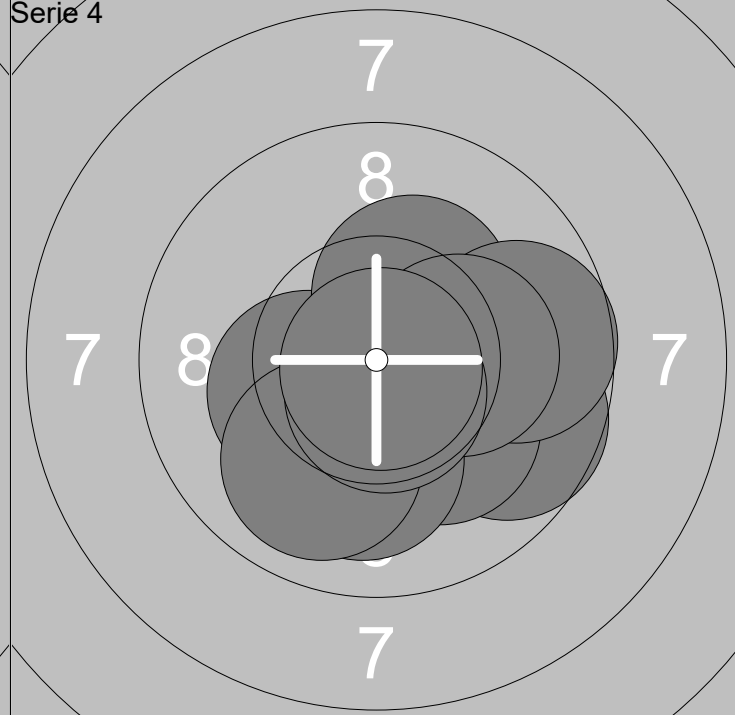

31: 10.3x ←
32: 10.3x ↗
33: 9.7 →
34: 10.2x ↘
35: 10.1 ↓

36: 9.7 →
37: 10.2x →
38: 10.0 ↓
39: 10.7x ↓
40: 10.9x ↓

Serie 98

Total 384

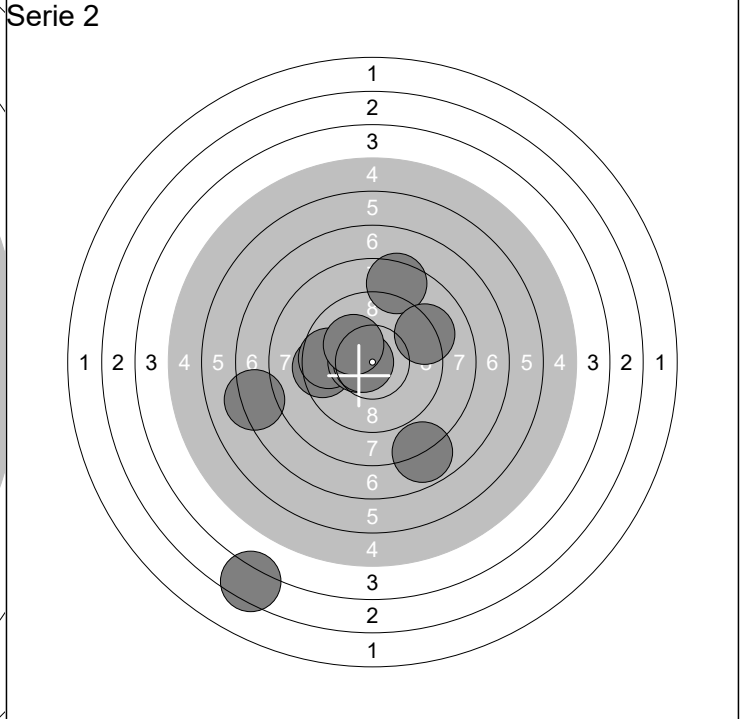
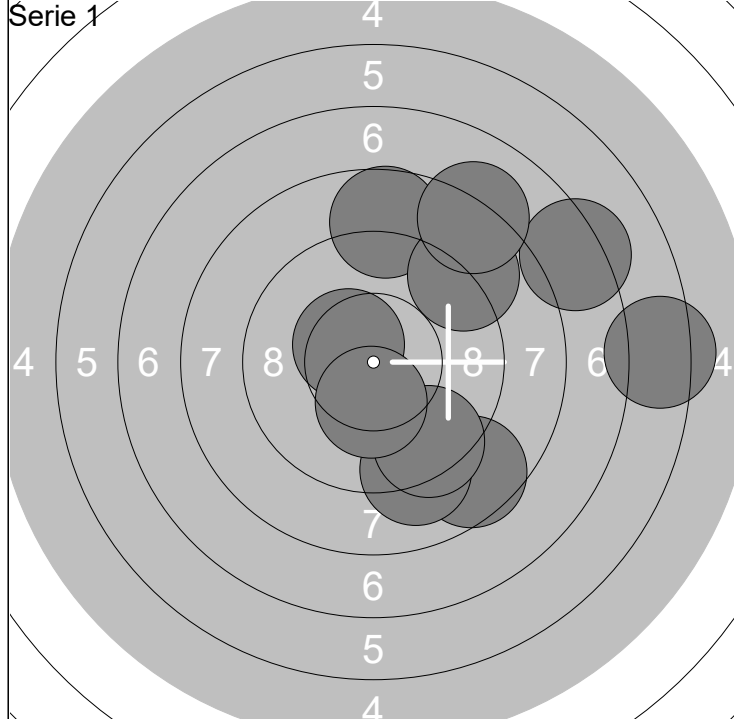

1: 8.6 ↘	6: 7.3 ↗	Serie	83
2: 6.3 →	7: 8.7 ↑		
3: 10.5x ↗	8: 8.9 ↗	Total	83
4: 9.1 ↘	9: 8.1 ↗		
5: 9.4 ↘	10: 10.3x ↓		

11: 9.4 ←	16: 8.5 ↑	Serie	82
12: 9.6 ←	17: 10.2x ↗		
13: 10.5x ←	18: 9.2 ↗	Total	165
14: 3.5 ↘	19: 7.9 ↘		
15: 10.7x ←	20: 7.3 ←		

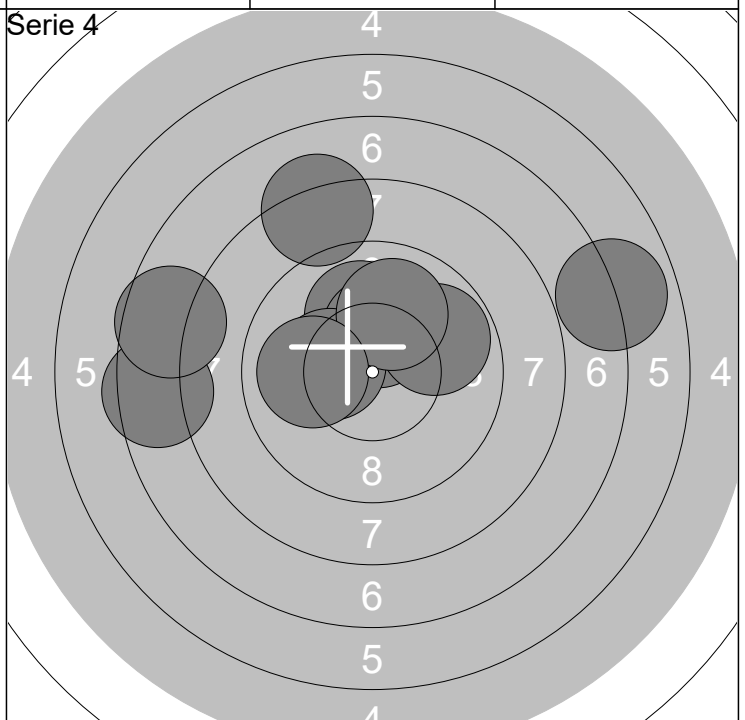
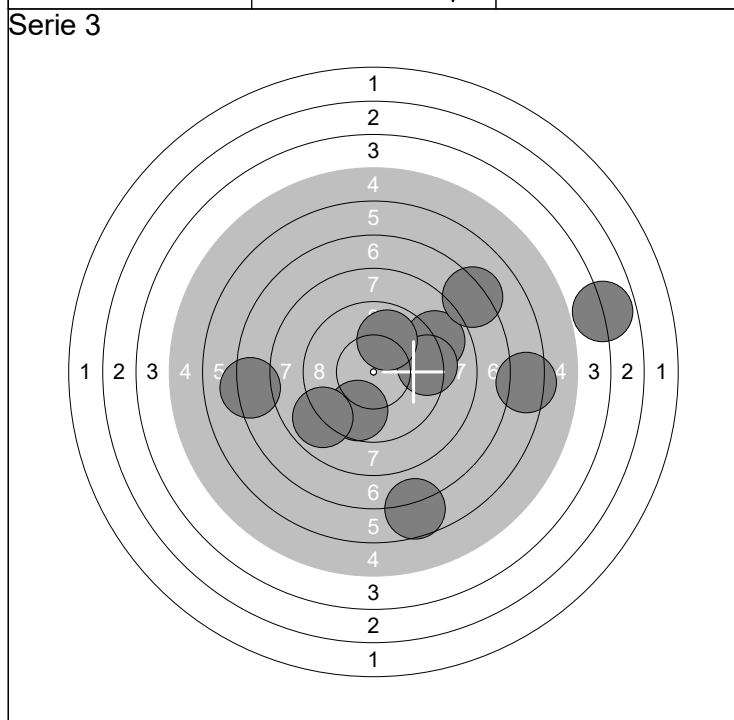

21: 8.9 ↗	26: 6.4 →	Serie	72
22: 3.9 →	27: 7.3 ←		
23: 6.7 ↘	28: 9.3 →	Total	237
24: 9.7 ↘	29: 9.9 ↗		
25: 7.2 ↗	30: 8.9 ↘		

31: 7.5 ←	36: 10.3x ←	Serie	87
32: 10.1 ↑	37: 10.0 ↑		
33: 10.3x ↑	38: 10.0 ←	Total	324
34: 8.2 ↑	39: 7.6 ←		
35: 9.8 ↗	40: 6.9 →		

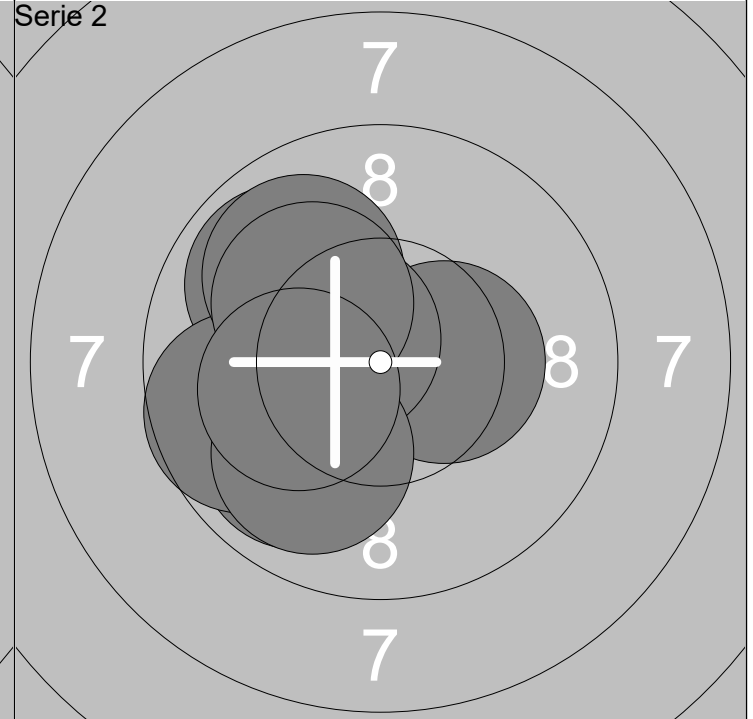
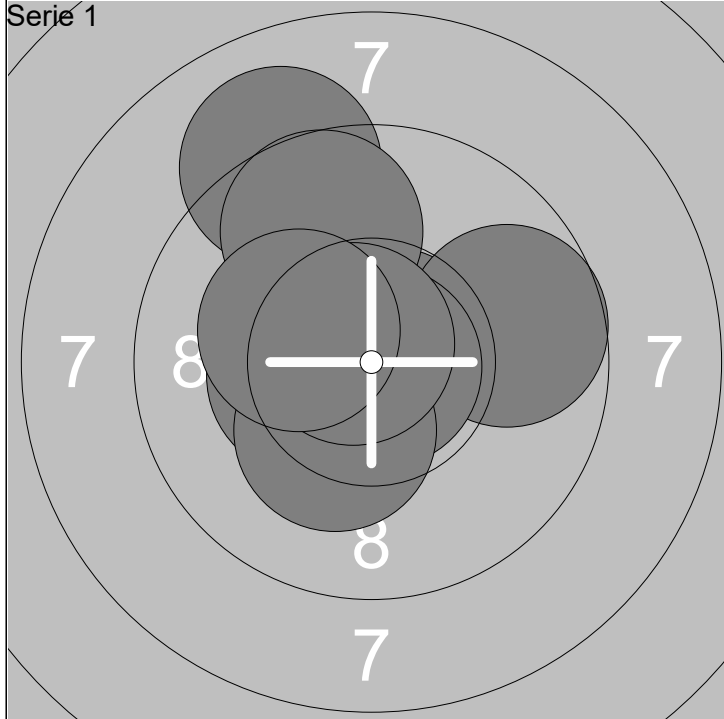

1: 10.8x ↗	6: 10.9x ↘	Serie	97
2: 10.7x ↖	7: 10.4x ↖		
3: 9.1 ↗	8: 10.3x ↘	Total	97
4: 9.7 ↗	9: 10.7x ↘		
5: 9.7 →	10: 10.3x ↖		

11: 10.4x →	16: 9.7 ↖	Serie	96
12: 10.4x ↖	17: 9.9 ↗		
13: 10.6x ↗	18: 10.1 ↗	Total	193
14: 9.9 ↗	19: 10.0 ↘		
15: 9.9 ↘	20: 10.2x ↖		

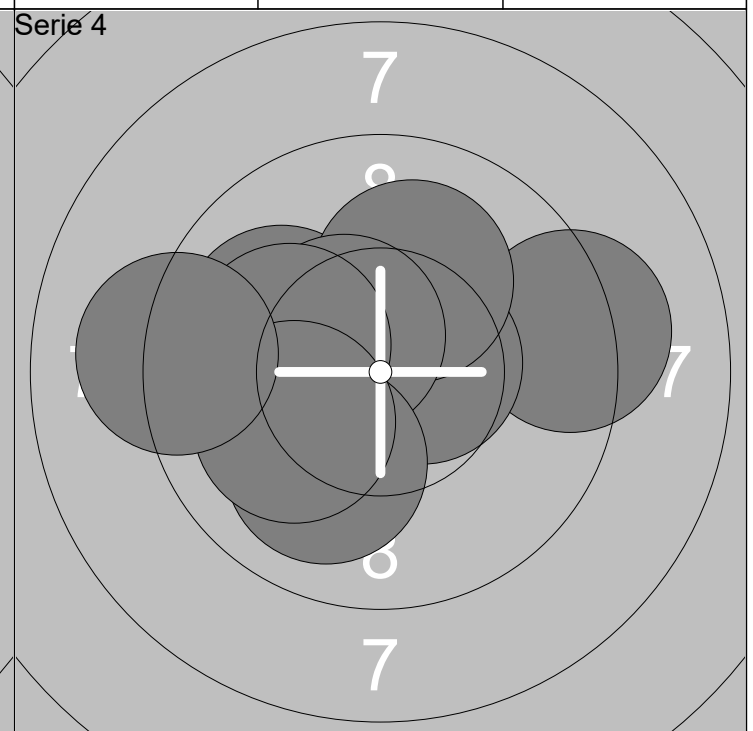
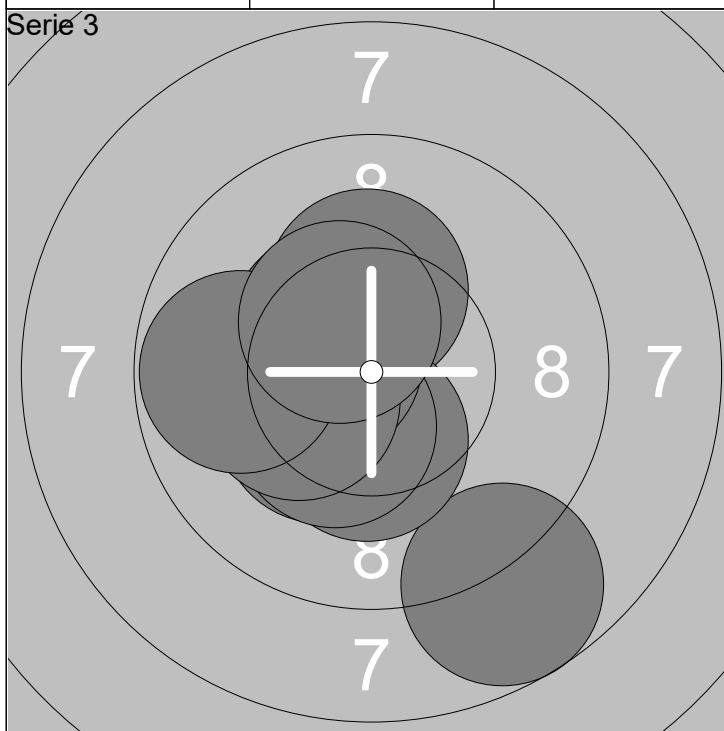

21: 10.3x ↖	26: 10.4x ↘	Serie	97
22: 8.7 ↘	27: 10.5x ↖		
23: 10.2x ↗	28: 10.3x ↖	Total	290
24: 10.4x ↘	29: 9.8 ↖		
25: 10.4x ↗	30: 10.4x ↗		

31: 10.6x ↗	36: 10.5x ↘	Serie	98
32: 9.2 →	37: 10.0 ↘		
33: 10.0 ↖	38: 10.1 ↖	Total	388
34: 10.6x →	39: 10.1 ↖		
35: 10.1 ↗	40: 9.1 ↖		

Skjutlag

Tavla

2

18

Wilma Svensson

Rottne Industri Cup 2018

Ingelstad Skytteklubb

L13J

27.10.2018

Rottne Industri Cup 2018

Söraby SKF

Serie 1

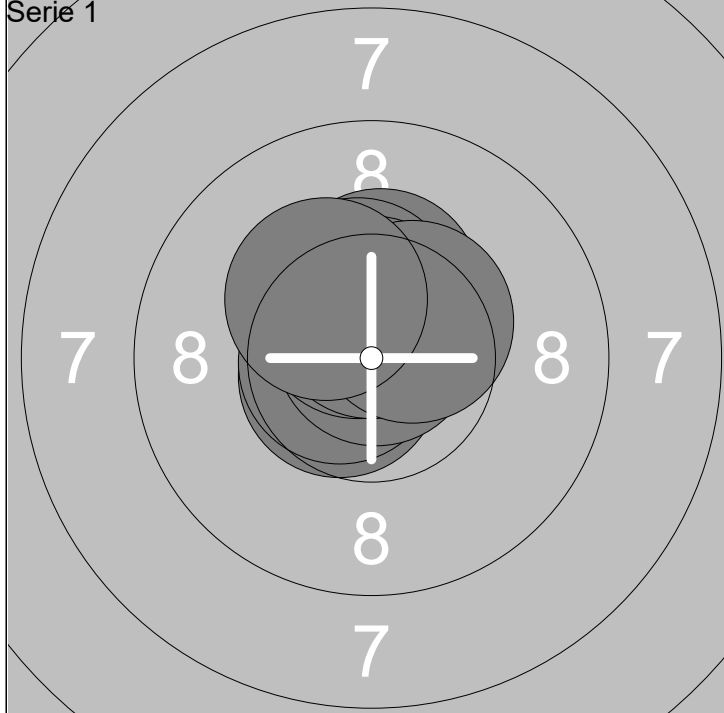

Serie 2

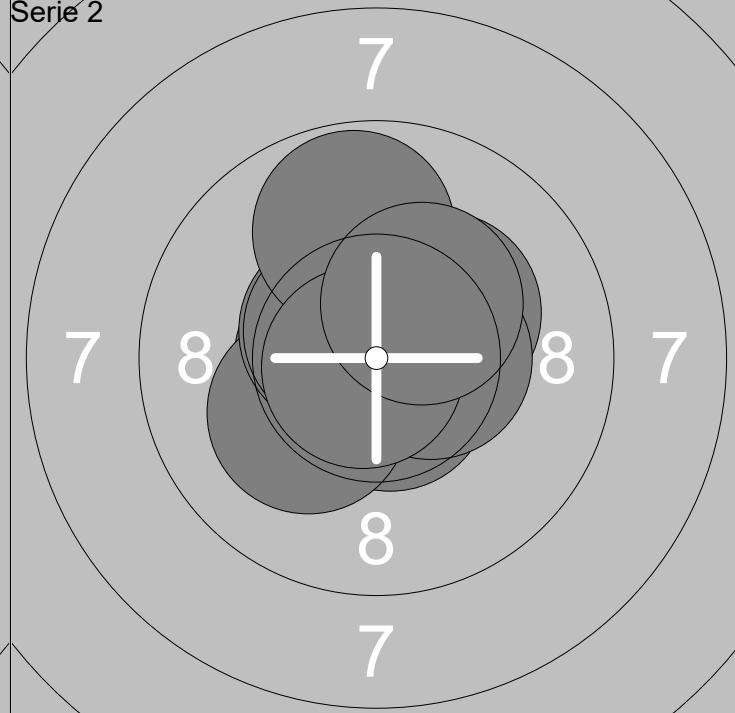

1: 10.6x ↙

6: 10.8x ↗

Serie 100

2: 10.8x ←

7: 10.6x ↗

3: 10.4x ↑

8: 10.6x ↑

4: 10.7x ←

9: 10.5x ↗

5: 10.4x ↑

10: 10.3x ↖

Total 100

11: 10.6x ↘

16: 10.5x →

Serie 99

12: 10.6x ←

17: 10.6x ↖

13: 10.2x ↗

18: 9.8 ↑

14: 10.2x ↙

19: 10.8x ←

15: 10.5x ↖

20: 10.3x ↗

Total 199

Serie 3

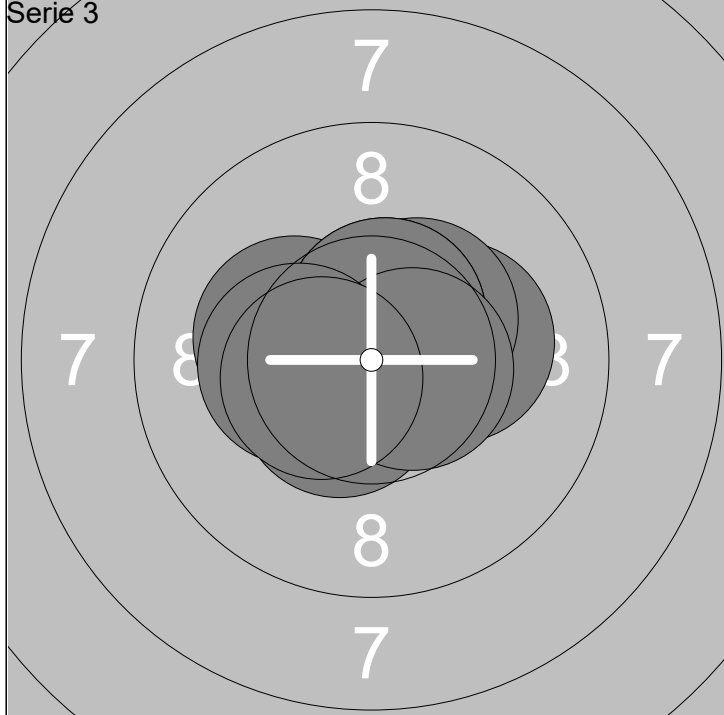

Serie 4

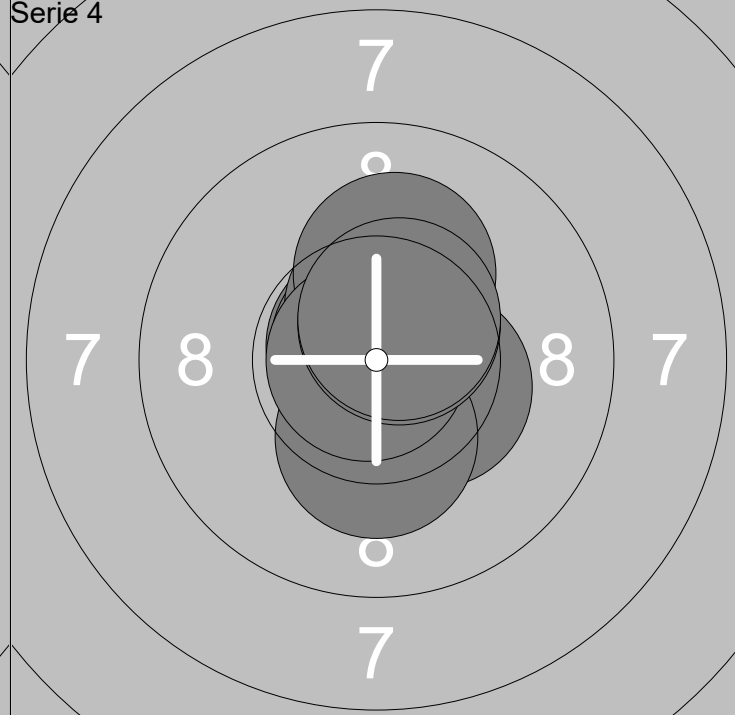

21: 10.2x ←

26: 10.5x ↙

Serie 100

22: 10.2x →

27: 10.6x ↗

23: 10.4x ↗

28: 10.6x →

24: 10.6x ↑

29: 10.3x ←

25: 10.9x ←

30: 10.5x ←

Total 299

31: 10.8x ↖

36: 10.2x ↑

Serie 100

32: 10.8x ↗

37: 10.3x ↓

33: 10.4x →

38: 10.9x ←

34: 10.4x ↑

39: 10.6x ↗

35: 10.5x ↑

40: 10.5x ↗

Total 399

Rottne Industri Cup 2018

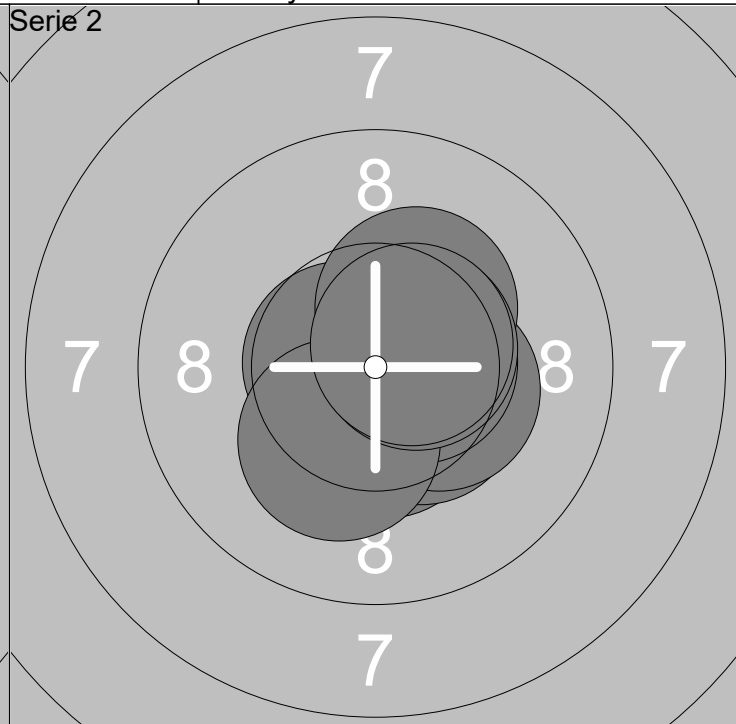
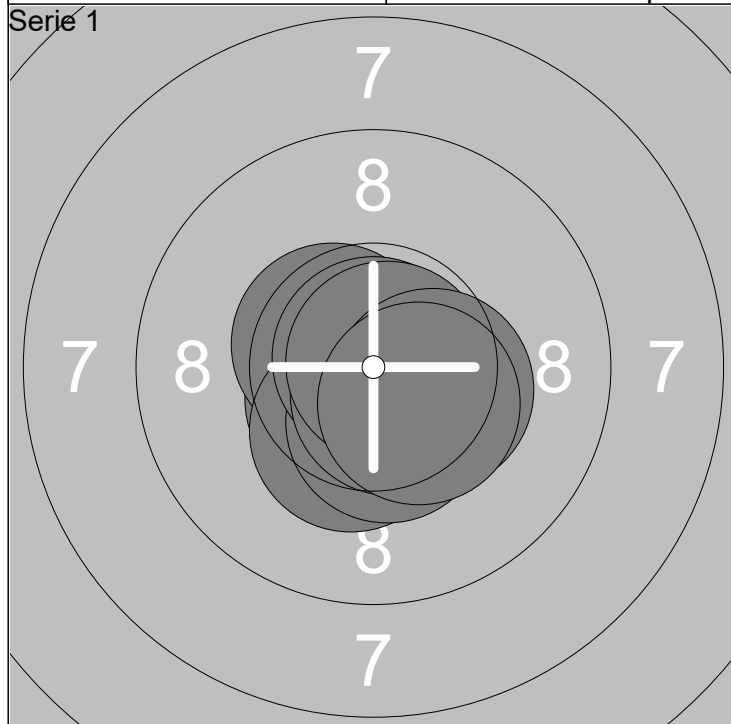

1: 10.6x ↙	6: 10.9x ↑	Serie 100
2: 10.5x ↖	7: 10.7x ↘	
3: 10.7x ↘	8: 10.8x →	Total 100
4: 10.4x ↙	9: 10.4x ↘	
5: 10.4x ↓	10: 10.4x ↘	

11: 10.7x ←	16: 10.6x →	Serie 100
12: 10.6x ↘	17: 10.2x ↙	
13: 10.5x ↓	18: 10.3x ↗	Total 200
14: 10.4x ↘	19: 10.6x ↗	
15: 10.4x →	20: 10.6x ↗	

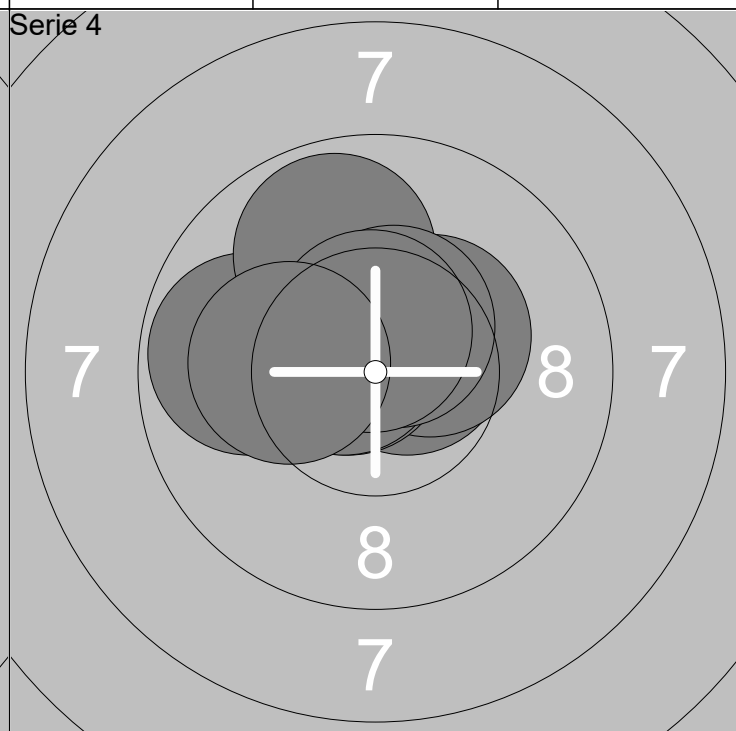
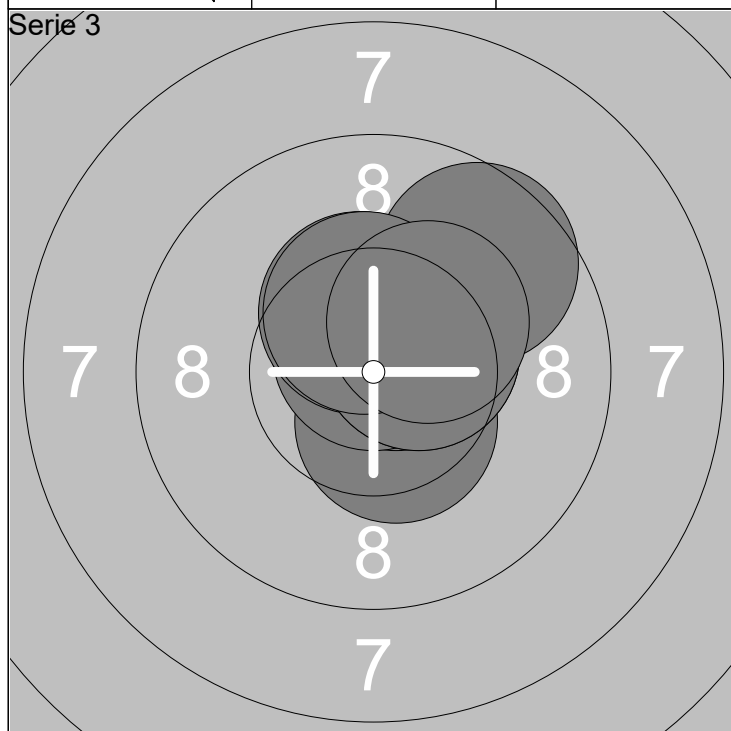

21: 10.5x ↙	26: 10.5x ↗	Serie 99
22: 10.7x ↗	27: 10.4x ↗	
23: 10.8x ↑	28: 10.5x ↗	Total 299
24: 10.4x ↑	29: 10.4x ↑	
25: 9.6 ↗	30: 10.3x ↗	

31: 10.6x ↗	36: 10.6x ↖	Serie 98
32: 9.8 ←	37: 10.6x ↖	
33: 10.5x ↑	38: 10.5x ↑	Total 397
34: 9.9 ↑	39: 10.6x ↑	
35: 10.4x ↗	40: 10.2x ←	

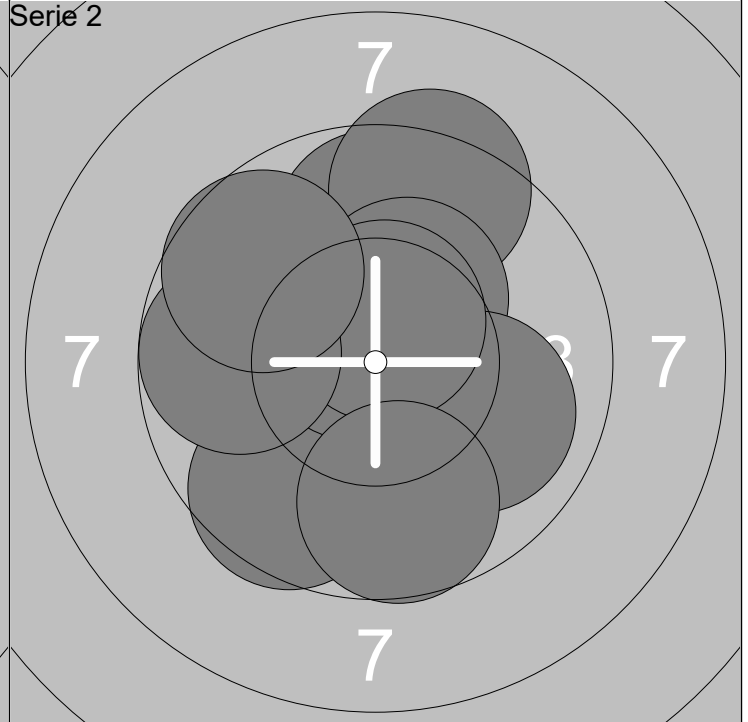
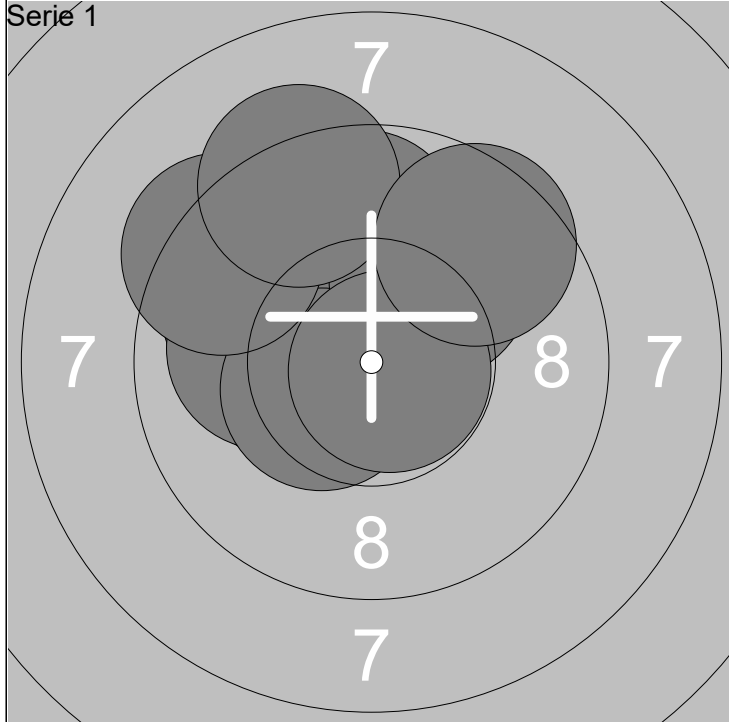

1: 10.3x ←	6: 10.1 ↗	Serie 95
2: 9.9 ↙	7: 10.8x ↘	
3: 9.8 ↑	8: 9.3 ↗	Total 95
4: 10.0 ←	9: 9.3 ↗	
5: 10.5x ↙	10: 9.5 ↗	

11: 9.8 ↑	16: 10.0 →	Serie 94
12: 9.3 ↑	17: 10.6x ↑	
13: 9.6 ↙	18: 9.8 ←	Total 189
14: 10.3x ↗	19: 9.7 ↓	
15: 10.7x ↙	20: 9.7 ↙	

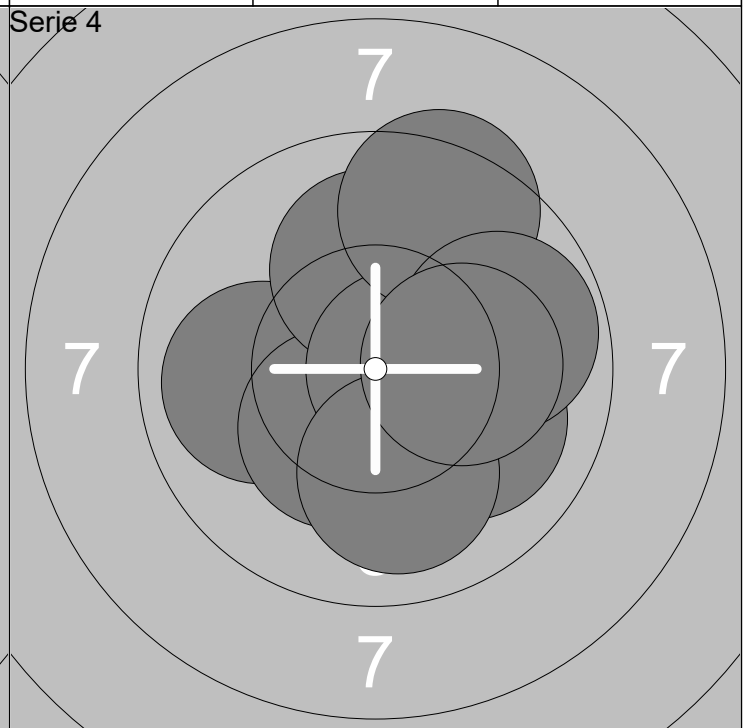
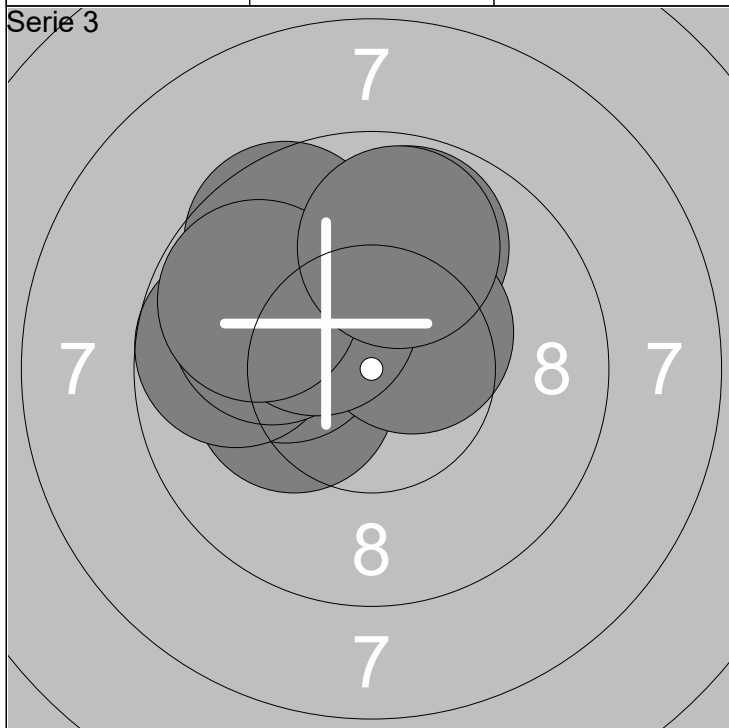

21: 10.2x ←	26: 10.0 ←	Serie 95
22: 10.2x ←	27: 10.3x ↗	
23: 9.7 ←	28: 9.6 ↗	Total 284
24: 9.8 ↑	29: 9.8 ↙	
25: 10.4x ↗	30: 9.9 ↑	

31: 10.0 ←	36: 10.7x →	Serie 98
32: 10.0 ↘	37: 9.4 ↑	
33: 10.3x ↓	38: 10.0 ↓	Total 382
34: 10.3x ↙	39: 9.8 →	
35: 10.1 ↑	40: 10.2x →	

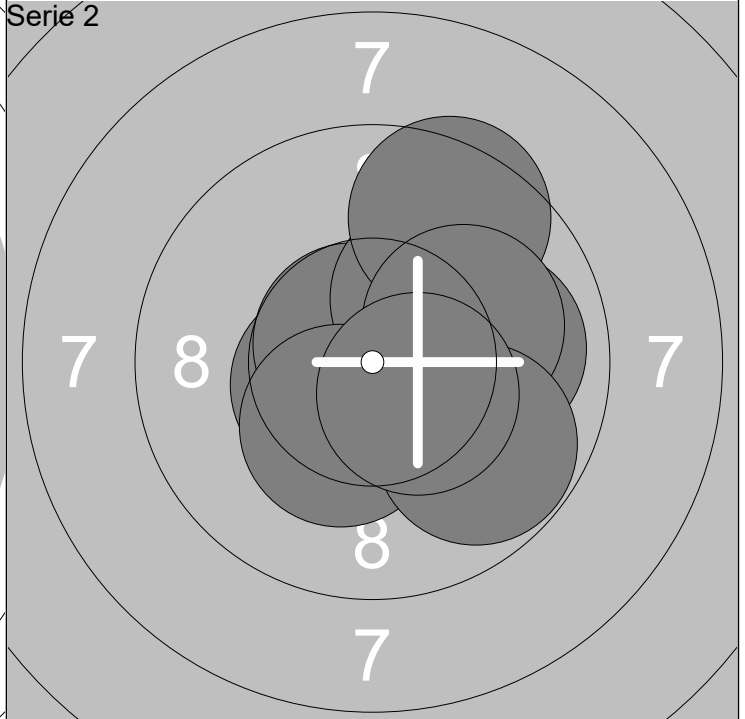
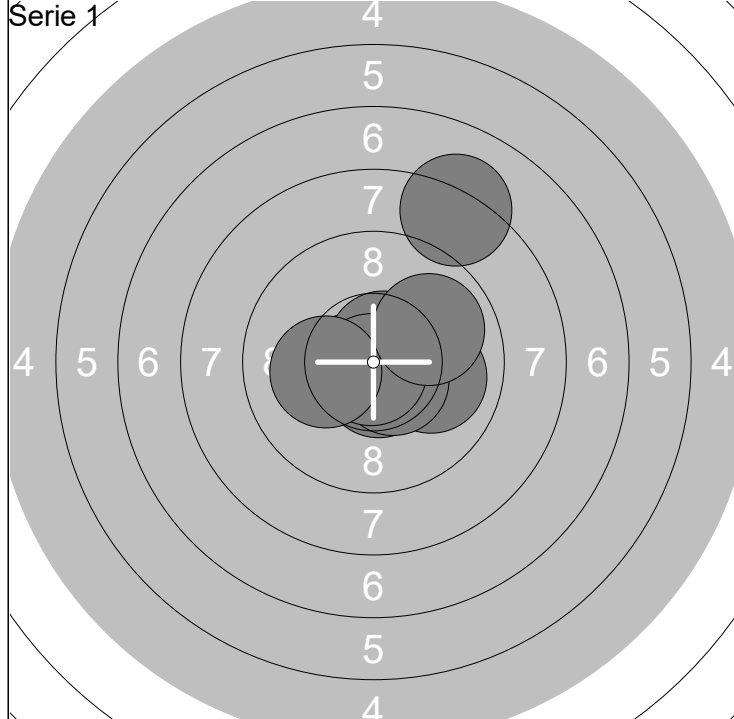

1: 10.8x →	6: 10.5x ↘	Serie	97
2: 10.0 →	7: 10.8x ↓		
3: 10.6x ←	8: 8.2 ↗	Total	97
4: 10.6x ↓	9: 10.2x ←		
5: 10.7x ↗	10: 9.9 ↘		

11: 10.5x ↙	16: 9.5 ↗	Serie	97
12: 10.1 →	17: 10.3x ↓		
13: 10.7x ↖	18: 10.1 →	Total	194
14: 9.9 →	19: 9.8 ↘		
15: 10.2x ↗	20: 10.5x ↘		

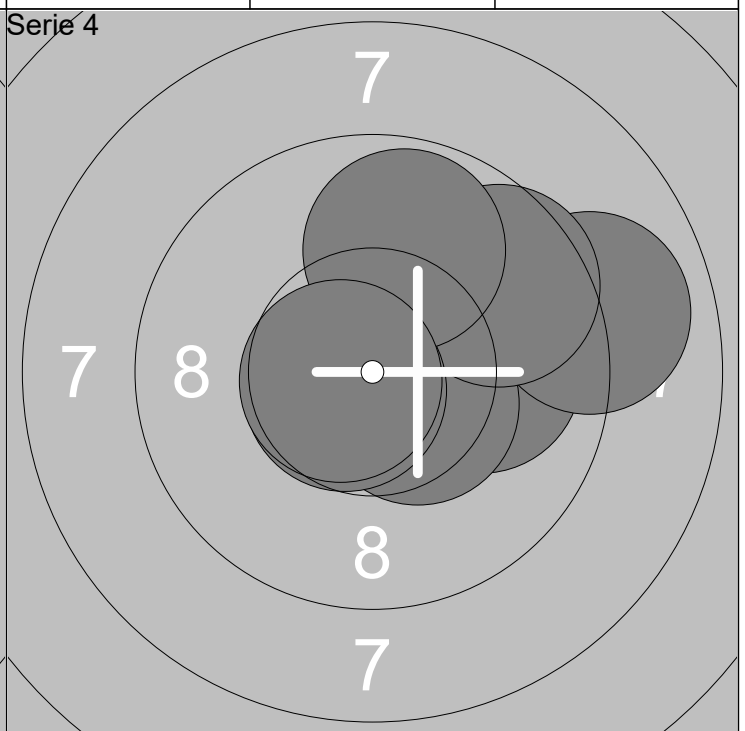
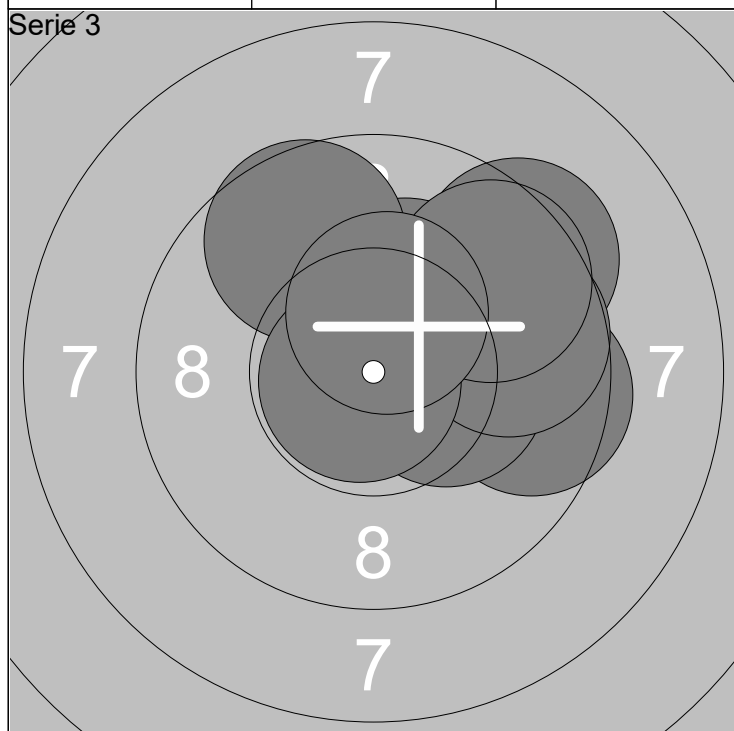

21: 10.2x ↗	26: 9.7 ↖	Serie	95
22: 10.2x ↘	27: 9.7 →		
23: 9.6 →	28: 9.6 ↗	Total	289
24: 9.3 ↗	29: 10.8x ↙		
25: 10.3x →	30: 10.4x ↗		

31: 10.2x ↗	36: 10.5x ↘	Serie	96
32: 10.0 →	37: 9.6 ↗		
33: 10.0 ↗	38: 10.7x ↙	Total	385
34: 8.9 →	39: 9.8 ↗		
35: 10.1 ↗	40: 10.7x ←		

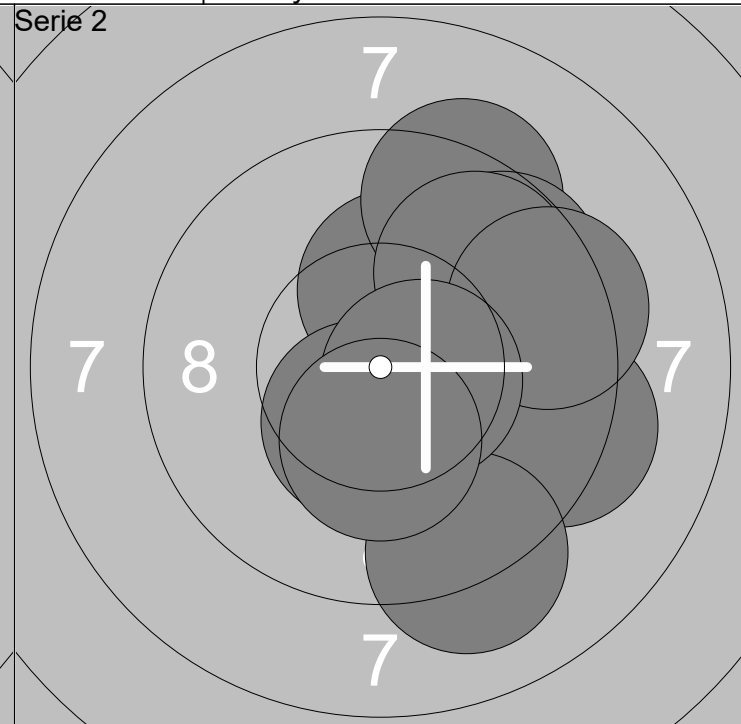
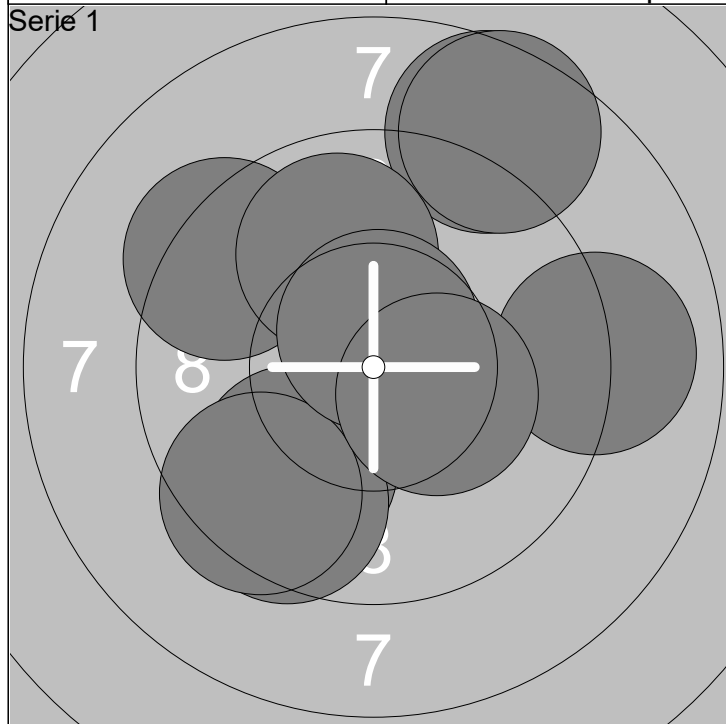

1: 9.3 ↖	6: 9.5 ↘	Serie	90
2: 9.8 ↙	7: 9.5 ↘		
3: 9.0 →	8: 10.6x ↑	Total	90
4: 8.6 ↗	9: 8.6 ↗		
5: 9.9 ↗	10: 10.3x →		

11: 10.3x ↑	16: 9.3 →	Serie	94
12: 9.3 ↗	17: 9.4 →		
13: 9.6 ↗	18: 9.1 ↘	Total	184
14: 10.5x ↘	19: 10.6x →		
15: 9.8 ↗	20: 10.3x ↓		

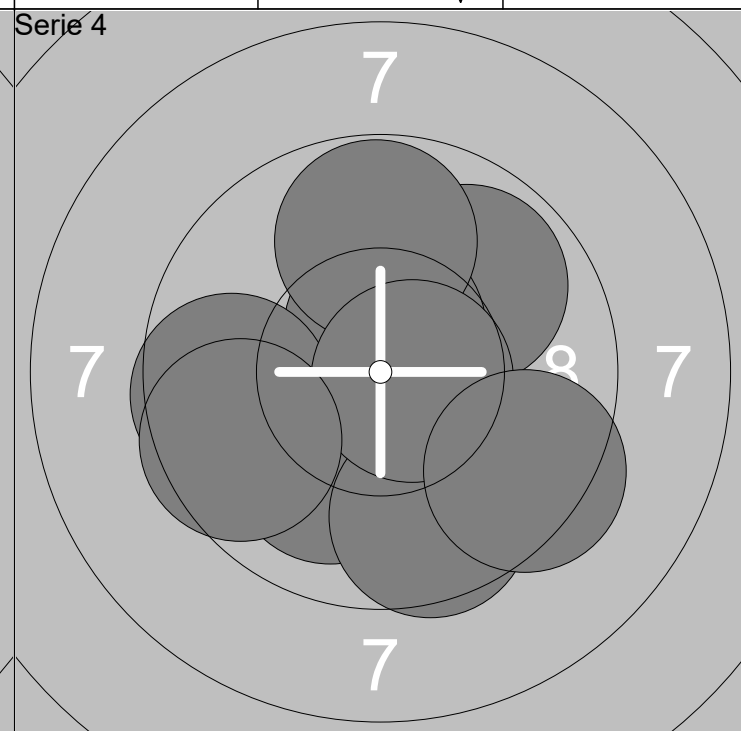
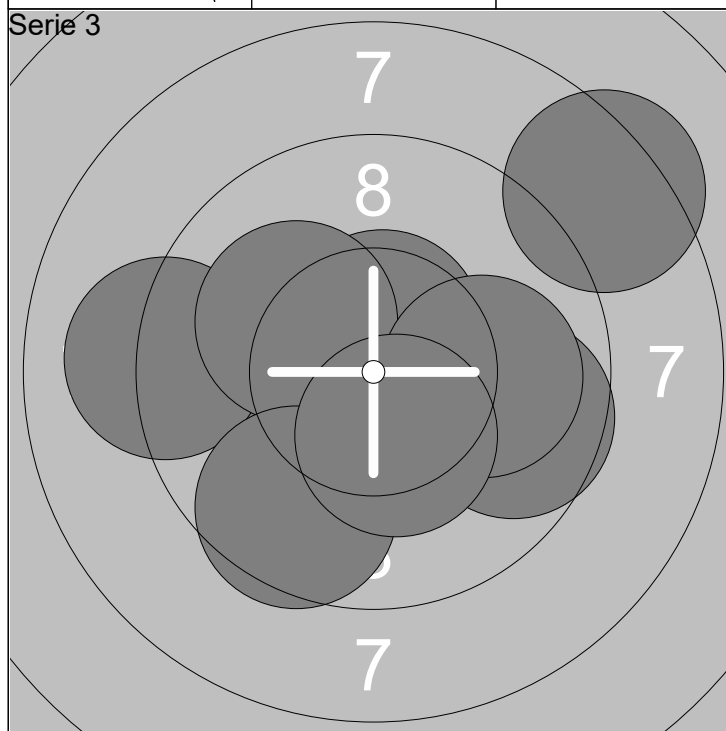

21: 9.6 →	26: 10.6x ↑	Serie	95
22: 10.1 ↘	27: 10.1 ↖		
23: 9.1 ←	28: 10.0 →	Total	279
24: 8.3 ↗	29: 9.6 ↘		
25: 10.4x →	30: 10.4x ↓		

31: 9.9 ↘	36: 9.6 ↘	Serie	93
32: 10.0 ↘	37: 9.6 ←		
33: 9.9 ↗	38: 10.7x →	Total	372
34: 10.6x ↑	39: 9.4 ↘		
35: 9.8 ↑	40: 9.6 ←		

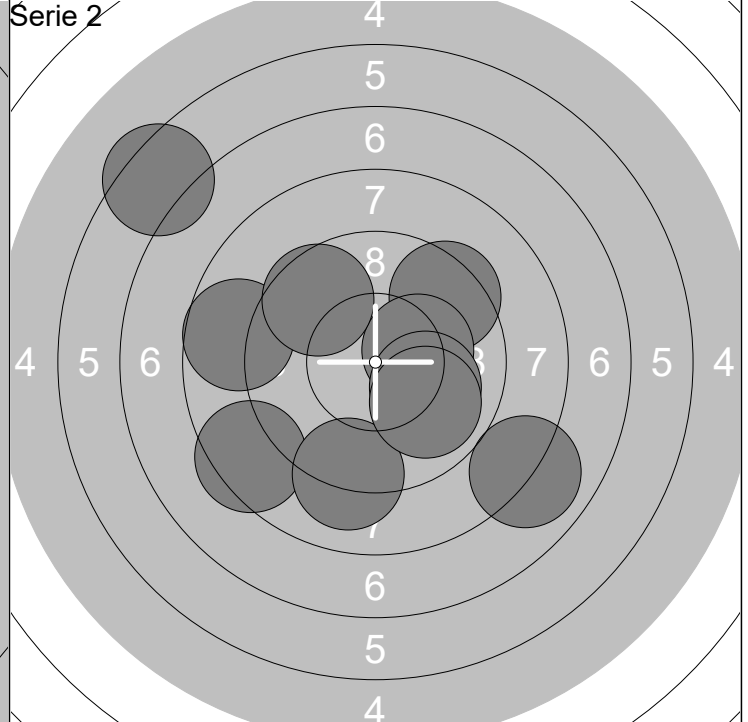
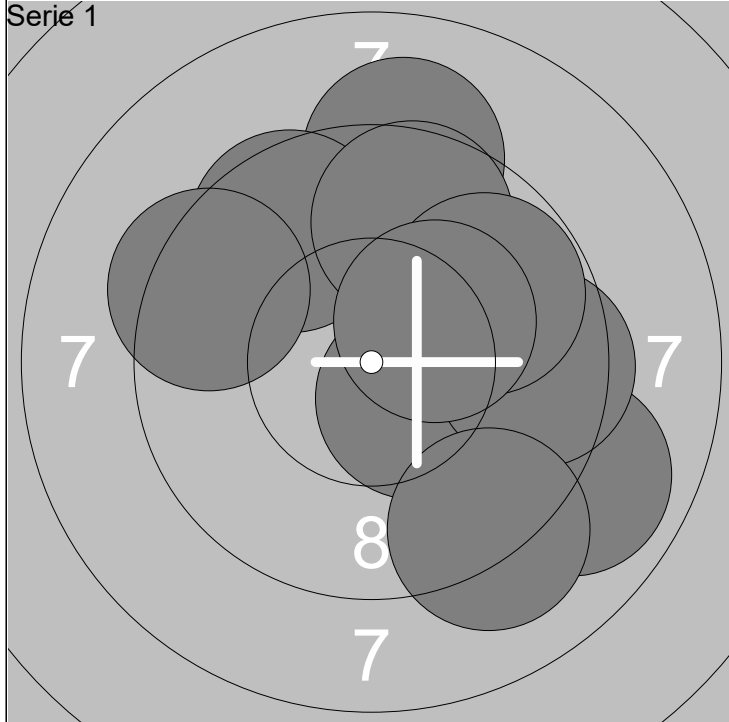

1: 9.1 ↑	6: 9.5 →	Serie	91
2: 10.5x ↓	7: 9.7 ↑		
3: 9.6 ↗	8: 9.8 ↗	Total	91
4: 8.9 ↓	9: 9.2 ↓		
5: 9.4 ↖	10: 10.3x ↗		

11: 9.4 ↗	16: 10.0 →	Serie	86
12: 8.4 ↙	17: 8.7 ↖		
13: 6.4 ↖	18: 8.0 ↓	Total	177
14: 9.1 ↓	19: 9.6 ↗		
15: 10.2x →	20: 9.9 ↓		

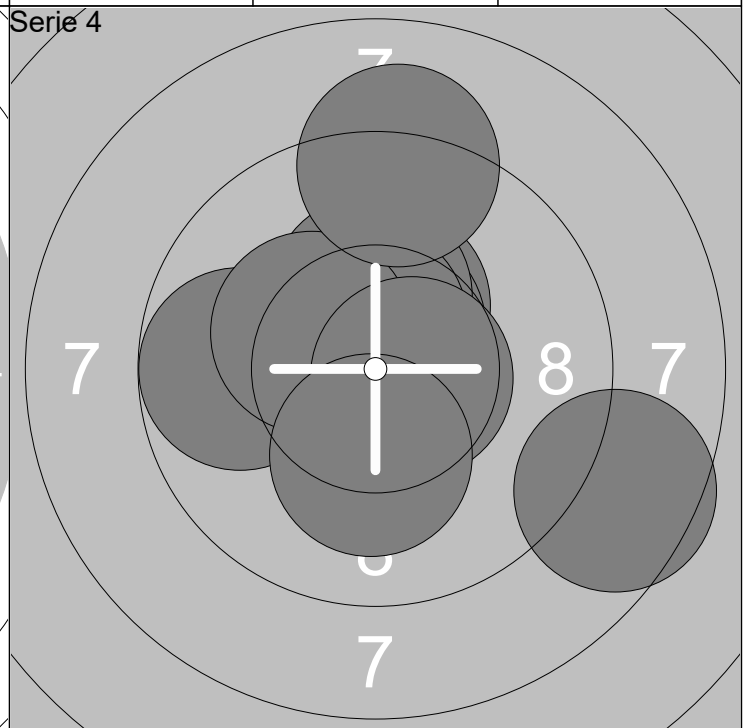
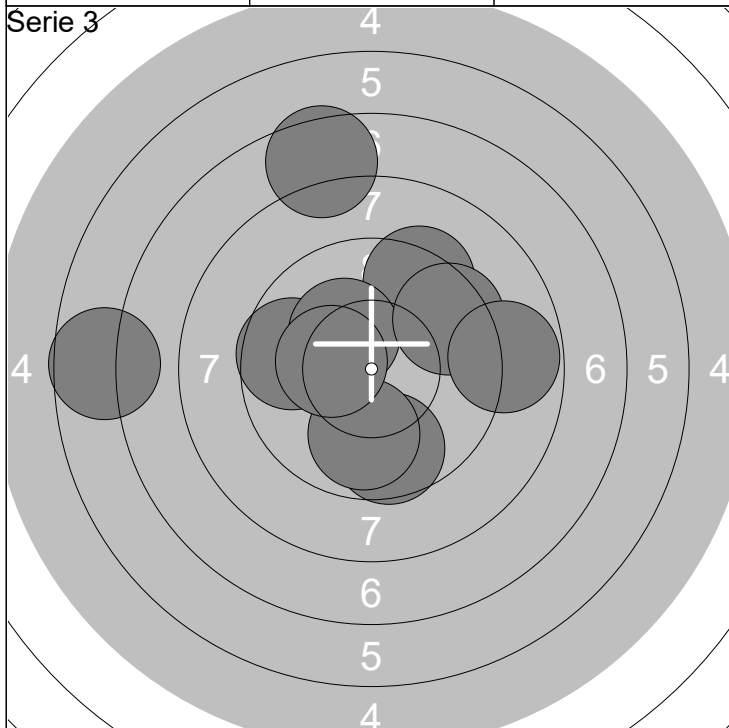

21: 9.6 ↓	26: 10.3x ↖	Serie	86
22: 9.7 ↖	27: 9.5 ↗		
23: 9.9 ↓	28: 8.8 →	Total	263
24: 6.7 ↖	29: 7.5 ↑		
25: 9.4 ↗	30: 10.3x ↖		

31: 10.4x ↑	36: 10.5x ↑	Serie	96
32: 8.6 →	37: 10.3x ↖		
33: 9.7 ↖	38: 10.6x →	Total	359
34: 10.6x ↑	39: 9.2 ↑		
35: 10.3x ↑	40: 10.2x ↓		

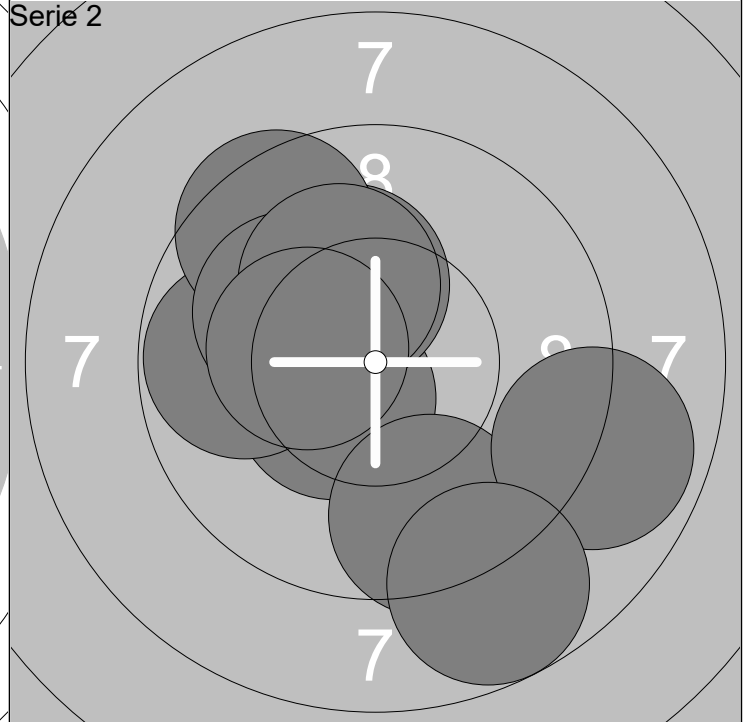
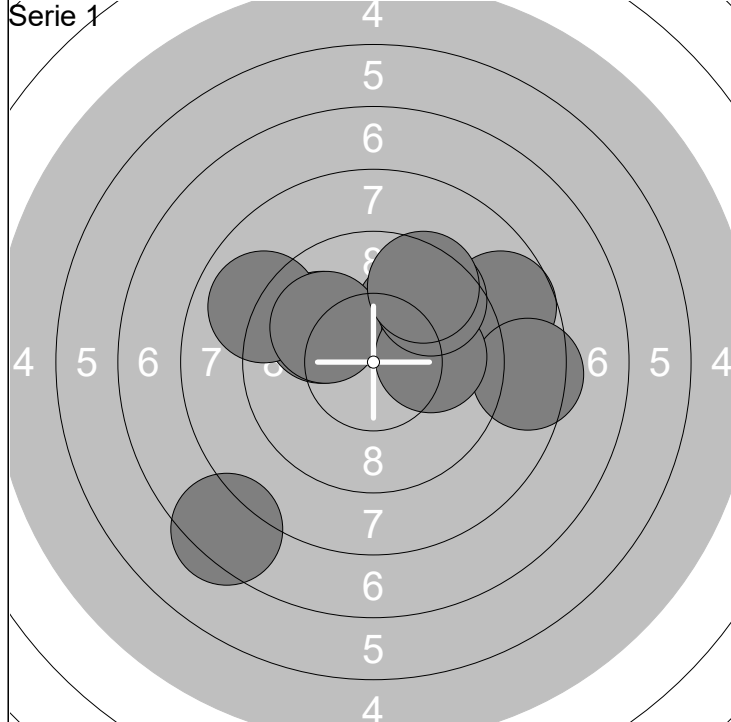

1: 8.7 →	6: 8.5 →	Serie	89
2: 9.9 ↖	7: 10.0 ↖		
3: 9.0 ↖	8: 10.0 →	Total	89
4: 10.0 ↗	9: 9.6 ↗		
5: 7.4 ↙	10: 9.5 ↗		

11: 10.5x ↙	16: 8.9 →	Serie	93
12: 9.5 ↓	17: 10.1 ↗		
13: 9.8 ←	18: 10.2x ↗	Total	182
14: 10.3x ↑	19: 8.8 ↓		
15: 9.5 ↖	20: 10.4x ←		

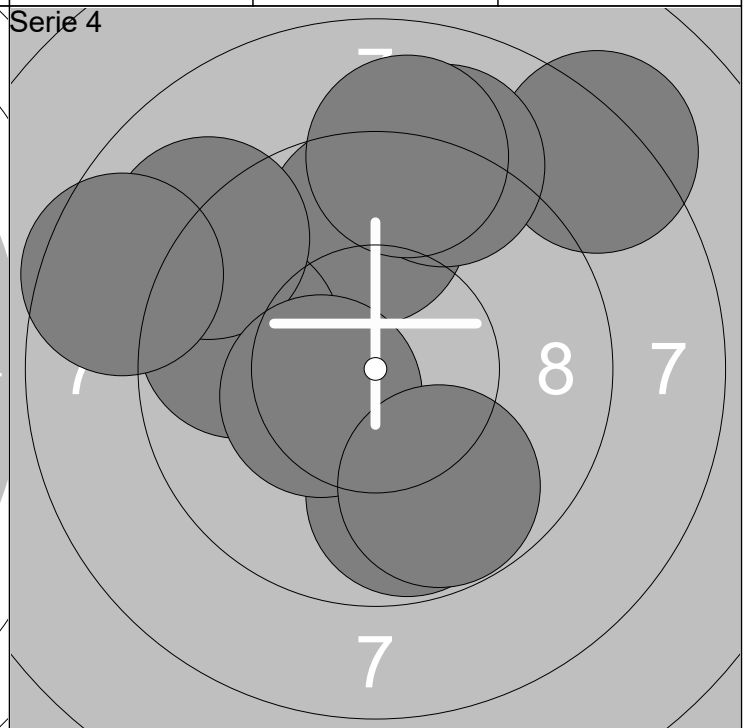
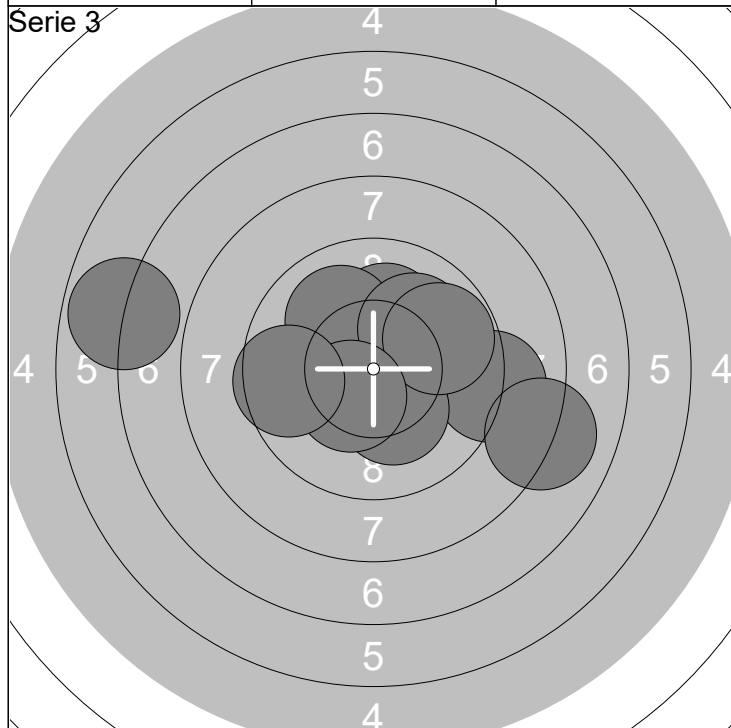

21: 10.1 ↑	26: 10.0 ↗	Serie	91
22: 10.0 ↗	27: 9.8 →		
23: 9.0 →	28: 10.4x ↙	Total	273
24: 8.1 →	29: 9.6 ←		
25: 10.2x ↓	30: 6.8 ←		

31: 9.8 ↓	36: 9.1 ↖	Serie	89
32: 9.7 ↑	37: 10.4x ↙		
33: 8.2 ↗	38: 9.8 ↓	Total	362
34: 9.1 ↑	39: 9.1 ↑		
35: 9.7 ←	40: 8.5 ←		

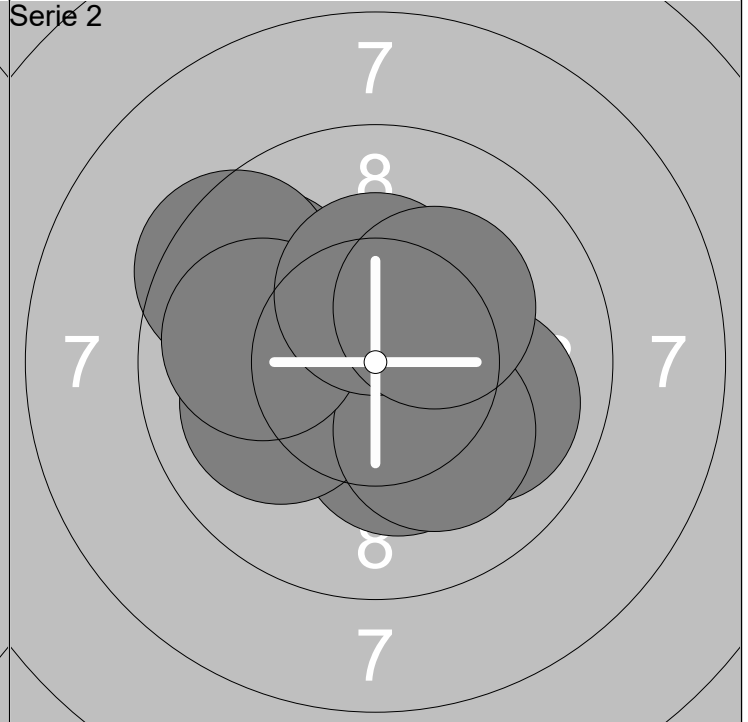
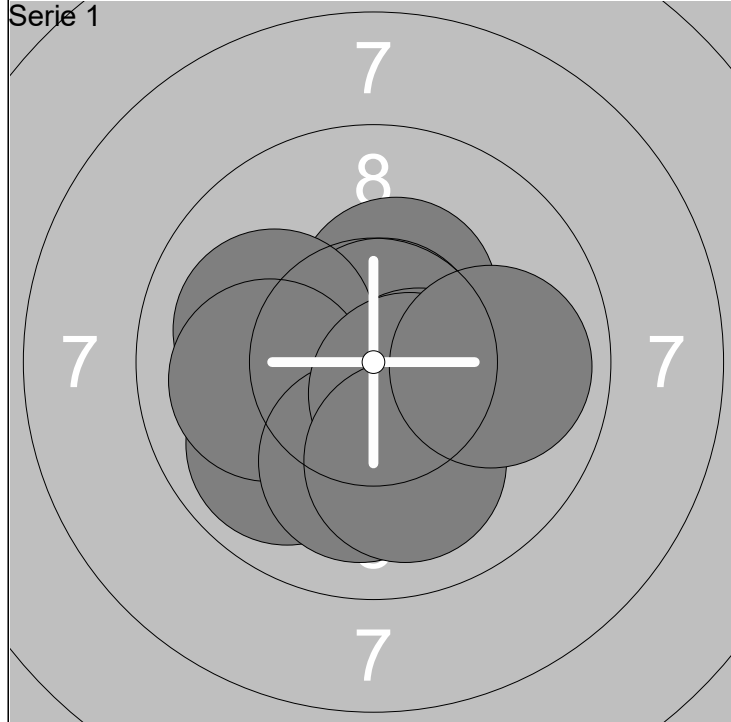

1: 9.9 ↙	6: 10.0 ←	Serie 98
2: 10.4x ↑	7: 10.1 ↓	
3: 10.7x ↑	8: 10.5x ↘	Total 98
4: 10.0 ↖	9: 10.0 ↓	
5: 10.5x ↘	10: 9.9 →	

11: 10.0 →	16: 9.5 ↗	Serie 97
12: 9.8 ↗	17: 10.2x ↘	
13: 10.3x ↓	18: 9.9 ←	Total 195
14: 10.7x ↑	19: 10.3x ↑	
15: 10.0 ←	20: 10.2x ↗	

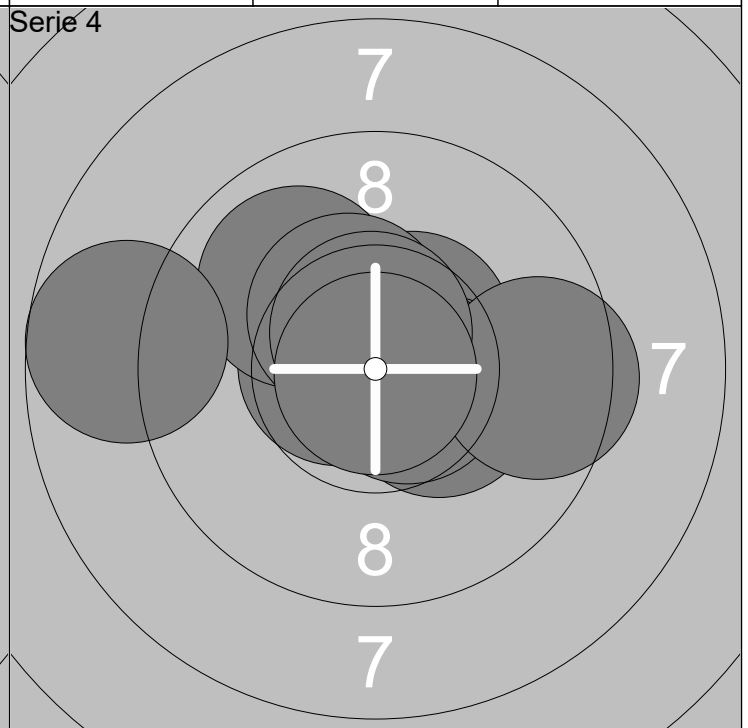
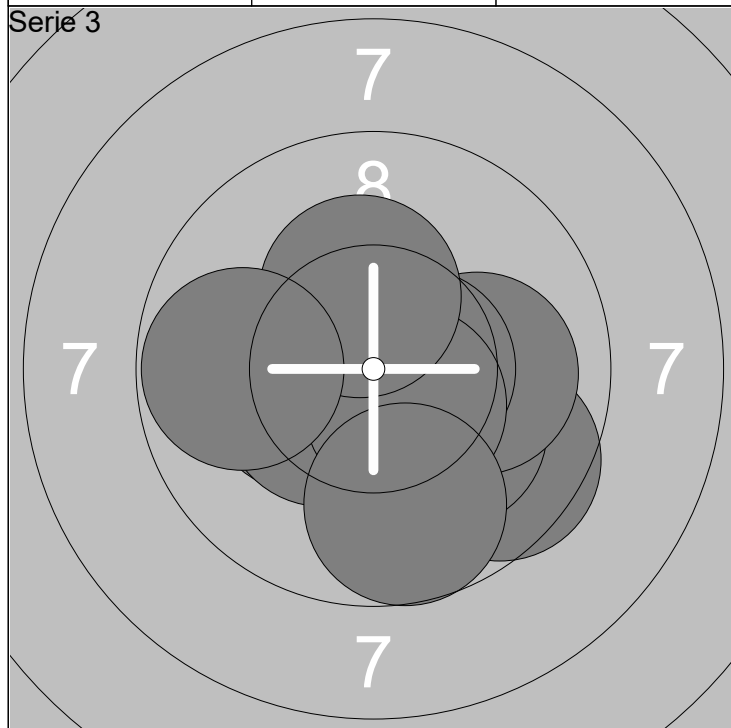

21: 9.6 ↘	26: 10.6x →	Serie 97
22: 10.1 ↘	27: 10.5x ↘	
23: 10.0 →	28: 9.7 ↓	Total 292
24: 10.3x ←	29: 10.3x ↑	
25: 10.4x ↙	30: 9.8 ←	

31: 10.5x ↗	36: 9.5 →	Serie 97
32: 10.3x →	37: 8.7 ←	
33: 10.6x ←	38: 10.4x ↗	Total 389
34: 10.0 ↗	39: 10.6x ↑	
35: 10.6x ↘	40: 10.9x ↓	

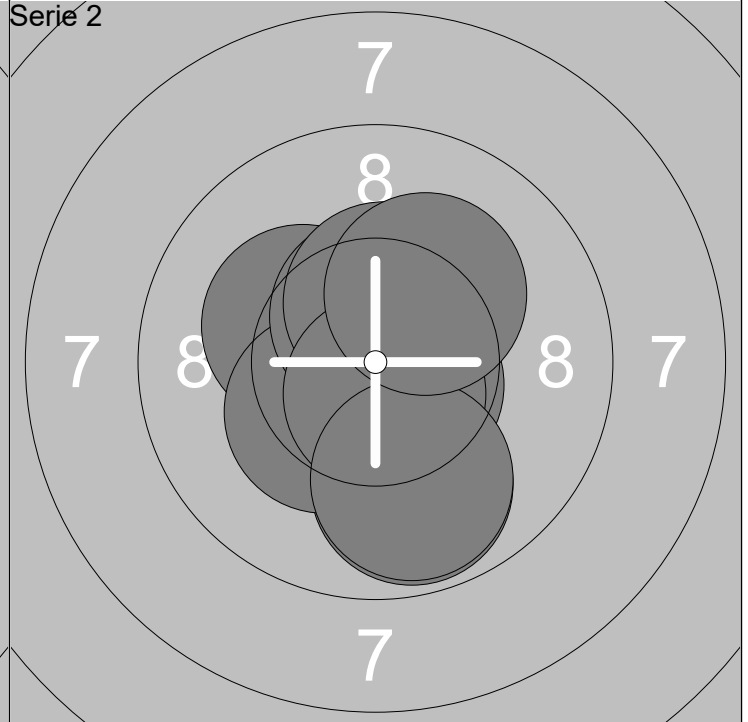
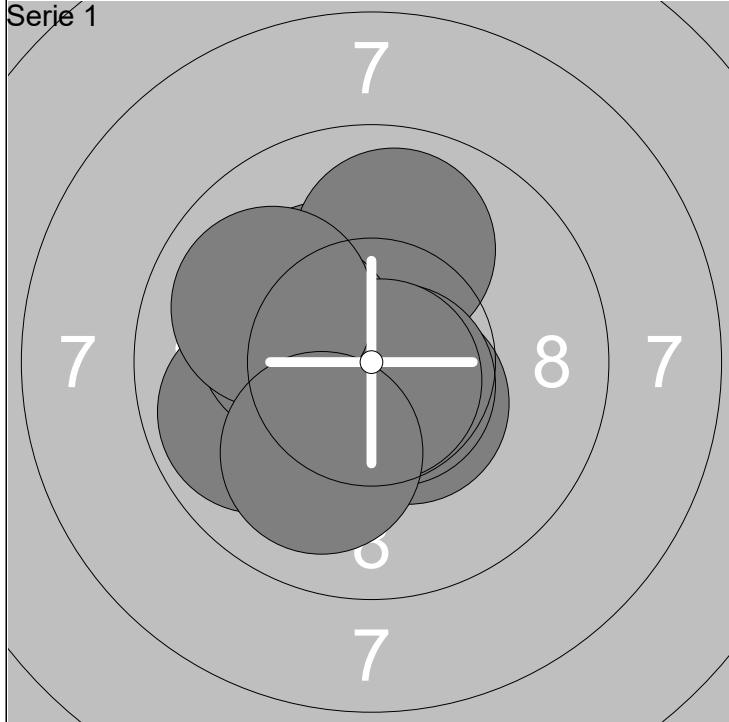

1: 9.9 ↙	6: 10.7x ↘	Serie 97
2: 10.5x ↘	7: 10.3x ↙	
3: 10.3x ↗	8: 10.8x ↘	Total 97
4: 9.9 ↗	9: 9.9 ↗	
5: 10.3x ↘	10: 10.0 ↘	

11: 9.8 ↘	16: 10.6x ↗	Serie 98
12: 10.2x ↙	17: 10.4x ↗	
13: 10.6x ↗	18: 10.7x ↘	Total 195
14: 10.6x ↘	19: 9.9 ↘	
15: 10.3x ↙	20: 10.2x ↗	

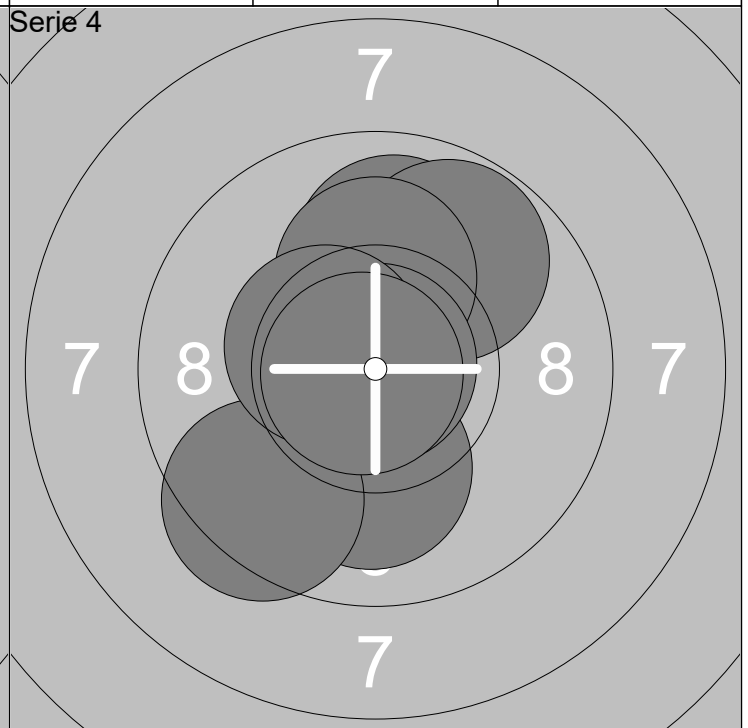
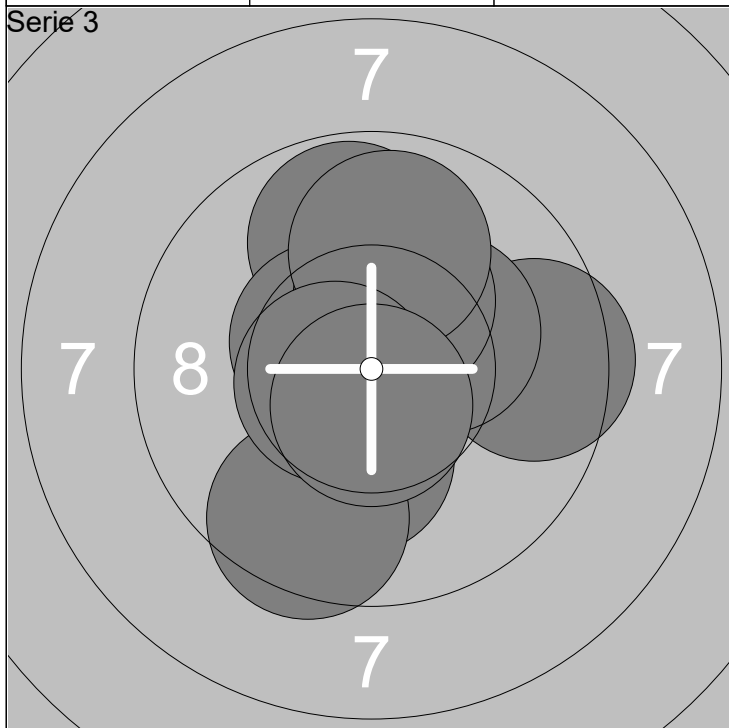

21: 9.5 →	26: 9.5 ↘	Serie 96
22: 10.3x ↗	27: 10.3x ↗	
23: 9.8 ↗	28: 9.9 ↗	Total 291
24: 10.5x ↙	29: 10.6x ↙	
25: 10.2x ↘	30: 10.6x ↘	

31: 9.9 ↗	36: 10.2x ↗	Serie 97
32: 10.6x ↙	37: 10.9x ↗	
33: 9.8 ↗	38: 9.4 ↘	Total 388
34: 10.8x ↙	39: 10.5x ↙	
35: 10.1 ↘	40: 10.8x ↙	

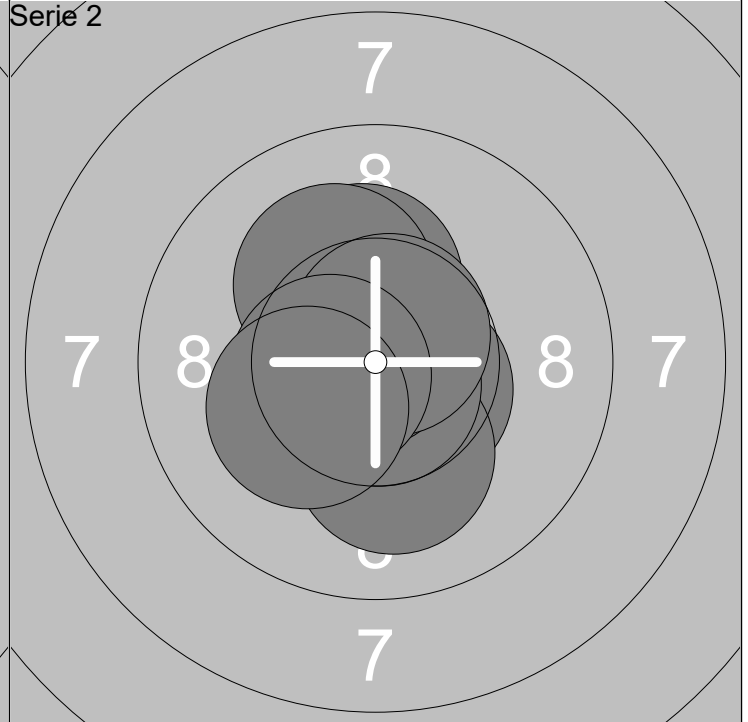
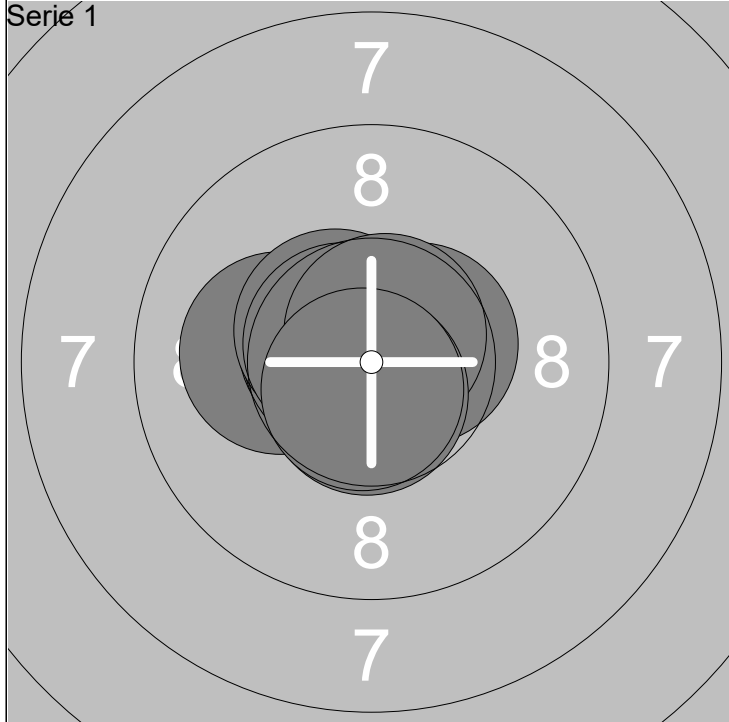

1: 10.1 ←	6: 10.7x →	Serie	100
2: 10.6x ↗	7: 10.5x →		
3: 10.7x ↖	8: 10.7x ↗	Total	100
4: 10.5x ↗	9: 10.7x ↓		
5: 10.6x ↖	10: 10.7x ↓		

11: 10.5x ↘	16: 10.8x ↗	Serie	100
12: 10.1 ↓	17: 10.2x ↗		
13: 10.5x ↗	18: 10.7x ↗	Total	200
14: 10.7x ↓	19: 10.5x ←		
15: 10.3x ↗	20: 10.2x ↖		

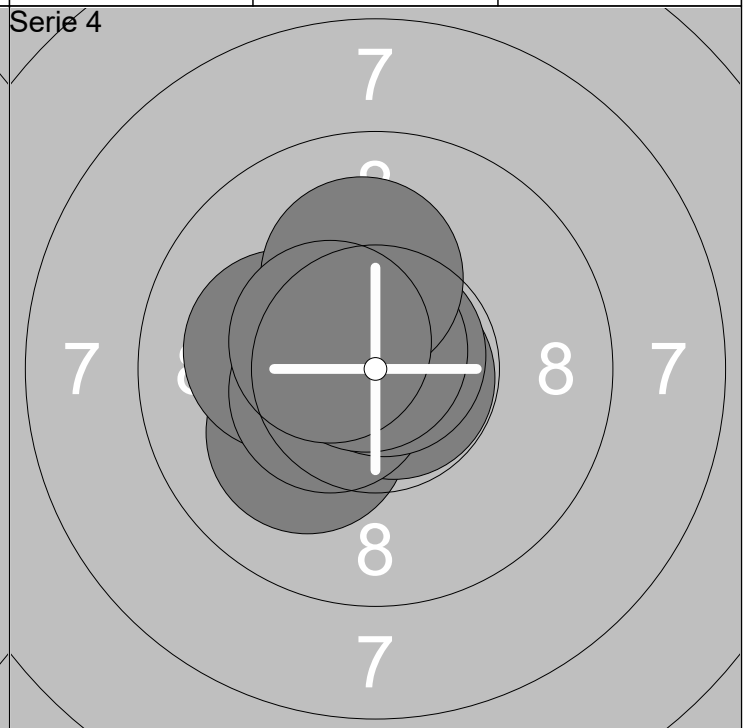
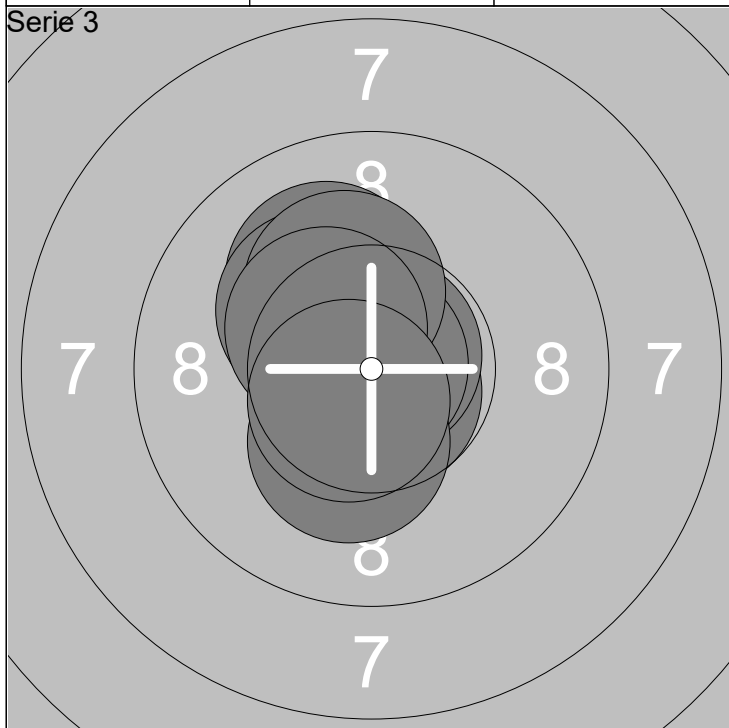

21: 10.1 ↗	26: 10.9x ↖	Serie	100
22: 10.7x ↓	27: 10.2x ↗		
23: 10.2x ↗	28: 10.3x ↓	Total	300
24: 10.8x ←	29: 10.4x ↖		
25: 10.8x ↗	30: 10.6x ↘		

31: 10.1 ↖	36: 10.5x ←	Serie	100
32: 10.9x ↗	37: 10.8x ↗		
33: 10.8x ↘	38: 10.8x ↗	Total	400
34: 10.5x ↖	39: 10.2x ↗		
35: 10.2x ←	40: 10.5x ↖		

Skjutlag

Tavla

3

7

Camilla Karlsson

Rottne Industri Cup 2018

Karlslunda Ungdomsskyttefören

Ösm

27.10.2018

Rottne Industri Cup 2018

Söraby SKF

Serie 1

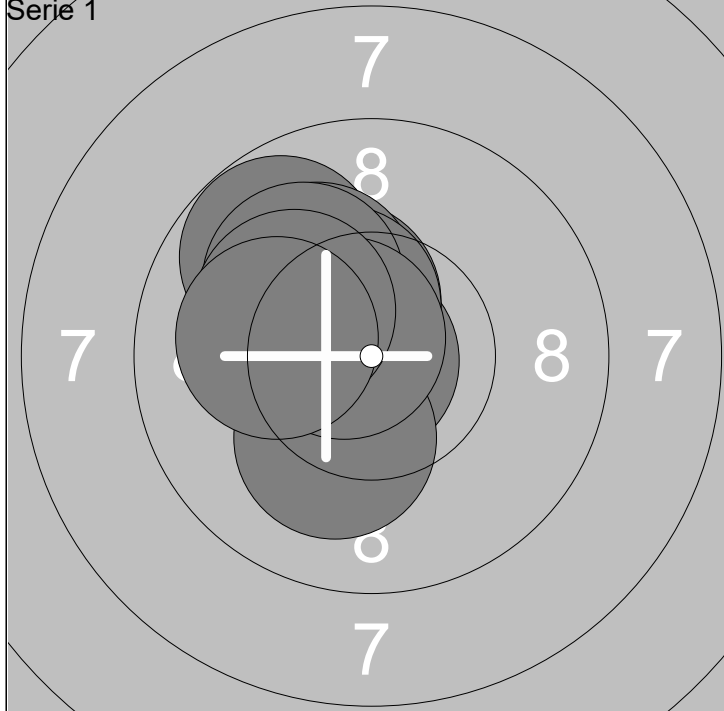

Serie 2

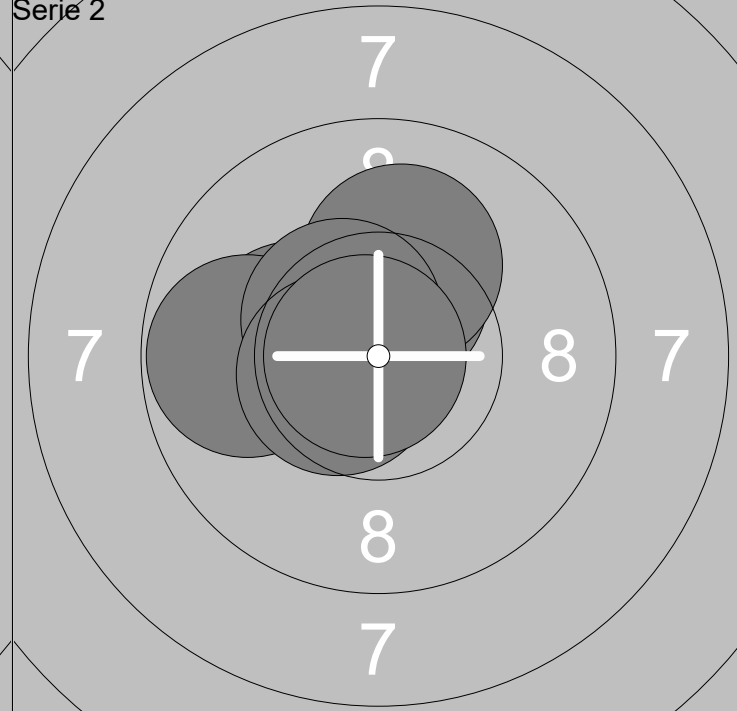

1: 9.8 ↗

6: 10.1 ↘

2: 10.8x ←

7: 10.1 ↗

3: 10.4x ↗

8: 10.7x ↗

4: 10.1 ↗

9: 10.2x ↗

5: 10.4x ↗

10: 10.1 ←

Serie 99

Total 99

11: 10.4x ↑

16: 10.1 ↑

12: 10.2x ←

17: 9.8 ←

13: 10.6x ←

18: 10.5x ↗

14: 10.4x ←

19: 10.6x ←

15: 10.5x ←

20: 10.8x ←

Serie 99

Total 198

Serie 3

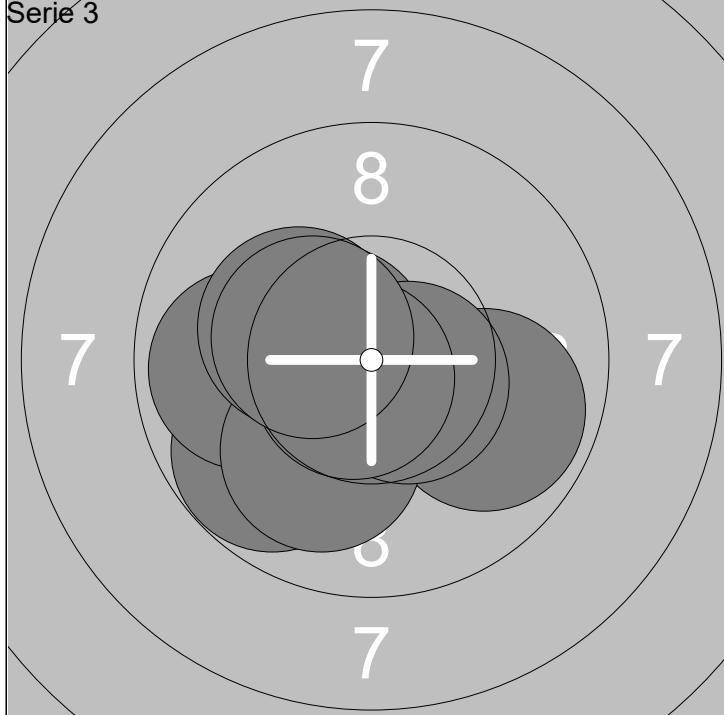

Serie 4

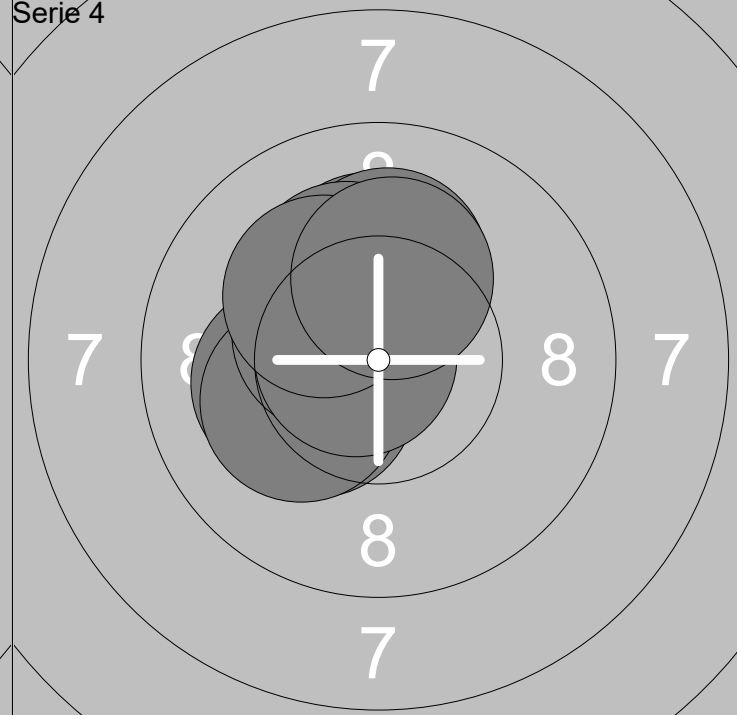

21: 10.6x ←

26: 10.0 ↘

22: 10.5x ↘

27: 10.2x ←

23: 9.8 ↘

28: 10.6x ↘

24: 9.9 ←

29: 10.7x ↘

25: 9.9 ↘

30: 10.4x ←

Serie 97

Total 295

31: 10.3x ←

36: 10.1 ↑

32: 10.2x ←

37: 10.8x ←

33: 10.2x ←

38: 10.2x ↗

34: 10.5x ↘

39: 10.2x ↗

35: 10.2x ↑

40: 10.2x ↑

Serie 100

Total 395

Rottne Industri Cup 2018

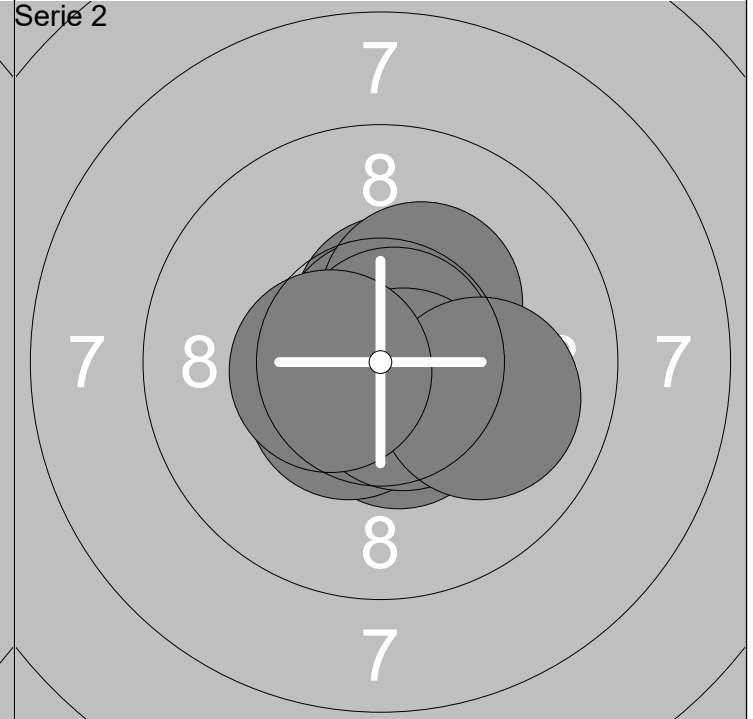
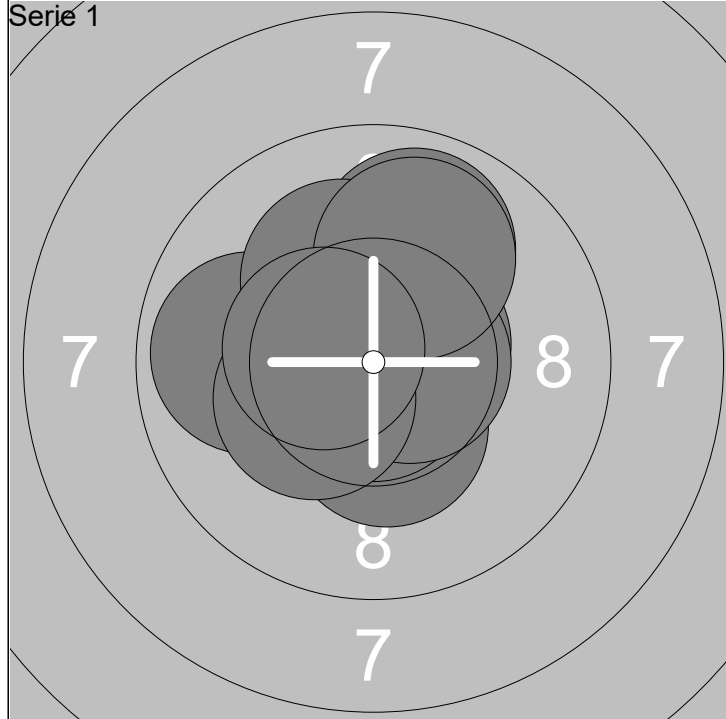

1: 9.9 ←	6: 9.9 ↗	Serie 98
2: 10.6x ↗	7: 10.2x ↗	
3: 10.4x ↓	8: 10.0 ↗	Total 98
4: 10.8x ↓	9: 10.3x ↙	
5: 10.6x →	10: 10.5x ←	

11: 10.5x ↓	16: 10.5x ↙	Serie 100
12: 10.5x ↗	17: 10.8x ↗	
13: 10.8x ↗	18: 10.6x ↓	Total 198
14: 10.6x ↗	19: 10.0 →	
15: 10.3x ↗	20: 10.5x ←	

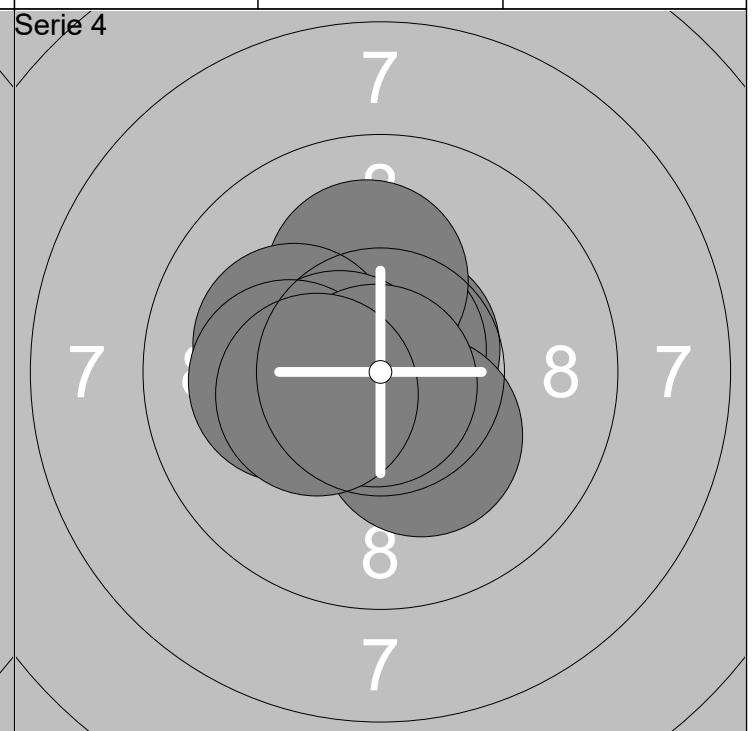
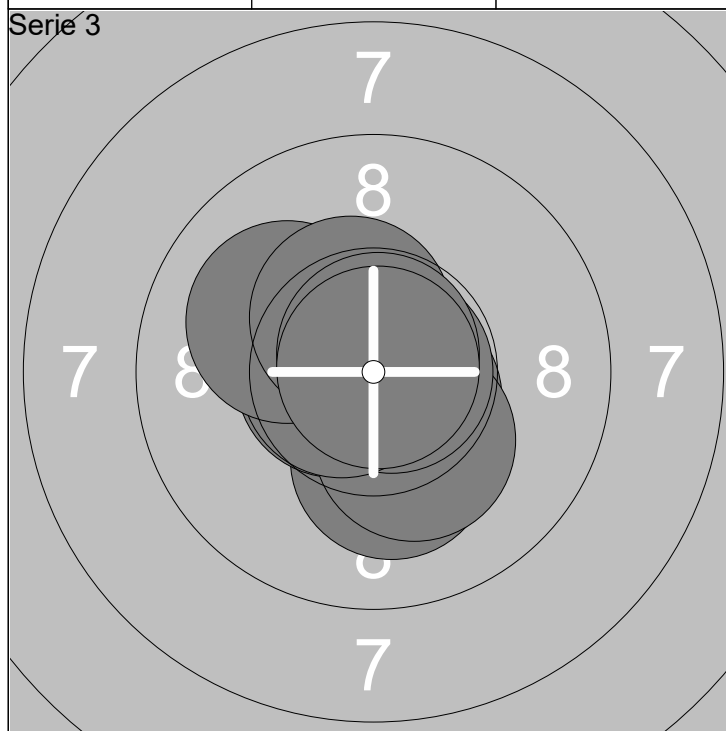

21: 10.2x ↓	26: 10.7x ←	Serie 100
22: 10.6x ←	27: 10.1 ↙	
23: 10.6x ↓	28: 10.4x ↗	Total 298
24: 10.3x ↓	29: 10.8x ↗	
25: 10.8x →	30: 10.9x ↗	

31: 10.6x ↙	36: 10.6x ←	Serie 100
32: 10.7x ↗	37: 10.3x ↓	
33: 10.8x ↗	38: 10.1 ←	Total 398
34: 10.1 ↗	39: 10.8x ↓	
35: 10.1 ←	40: 10.3x ←	

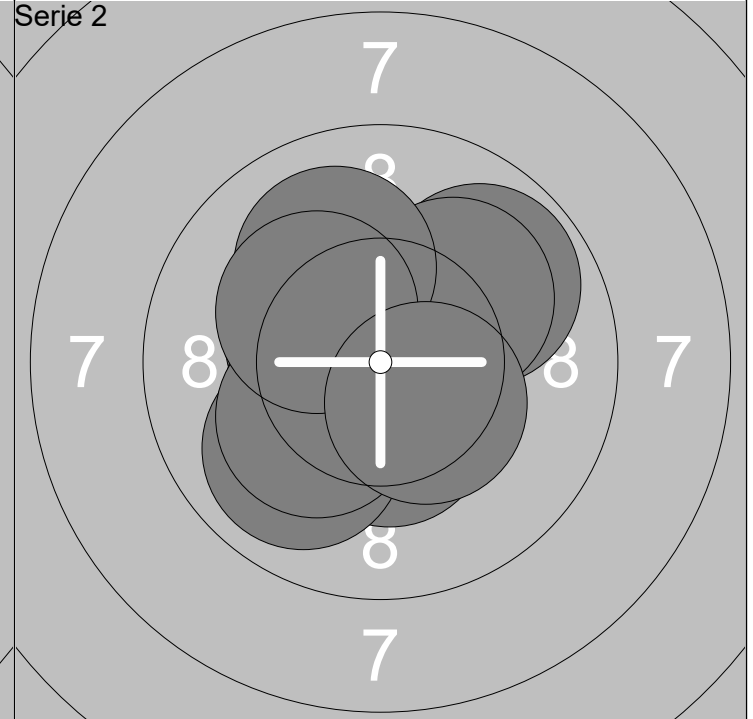
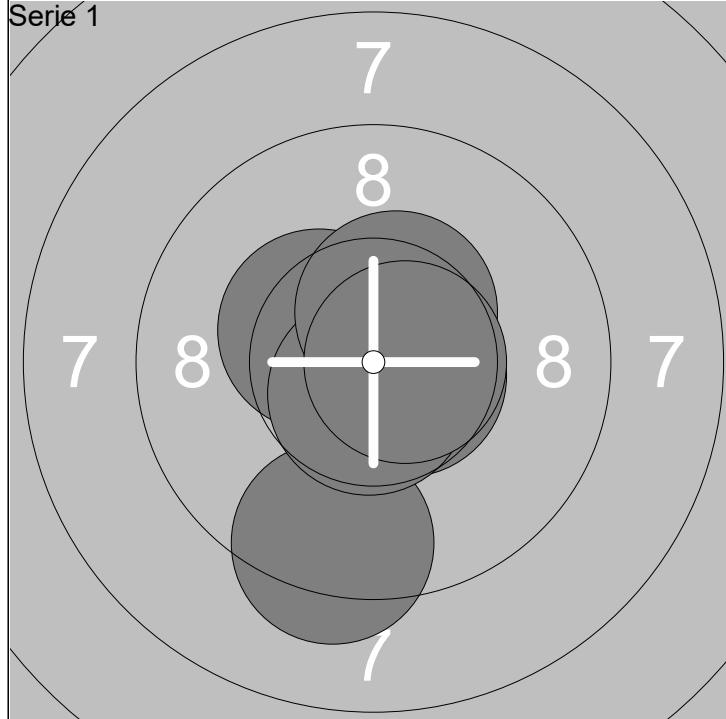

1: 9.3 ↓	6: 10.8x ↙	Serie	99
2: 10.7x →	7: 10.4x ↖		
3: 10.7x ↗	8: 10.7x ↓	Total	99
4: 10.6x ➔	9: 10.5x ↗		
5: 10.7x ↗	10: 10.7x →		

11: 10.4x ↖	16: 10.2x ↙	Serie	98
12: 10.4x ↓	17: 10.1 ↗		
13: 9.9 ↙	18: 10.0 ↗	Total	197
14: 9.8 ↗	19: 10.2x ↖		
15: 10.4x ↙	20: 10.4x ↘		

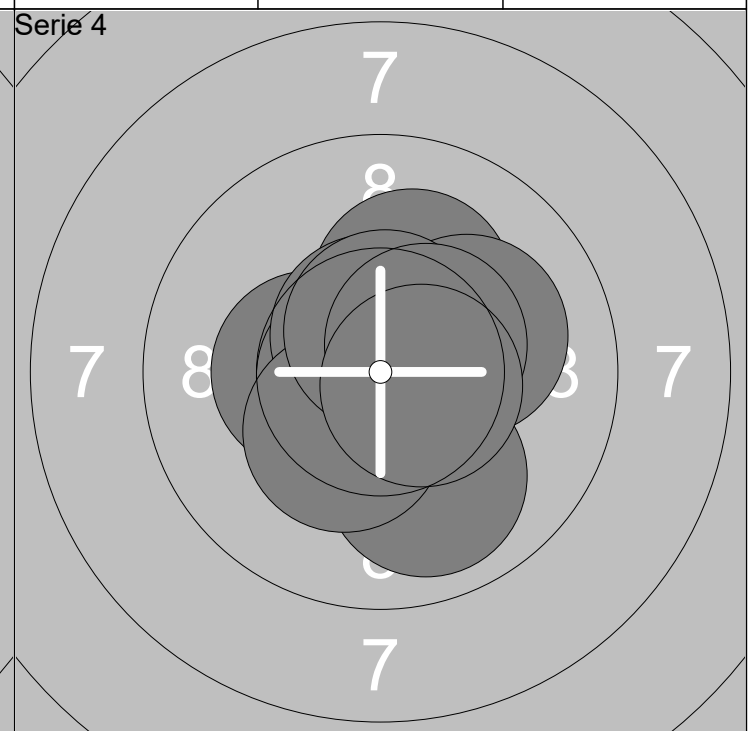
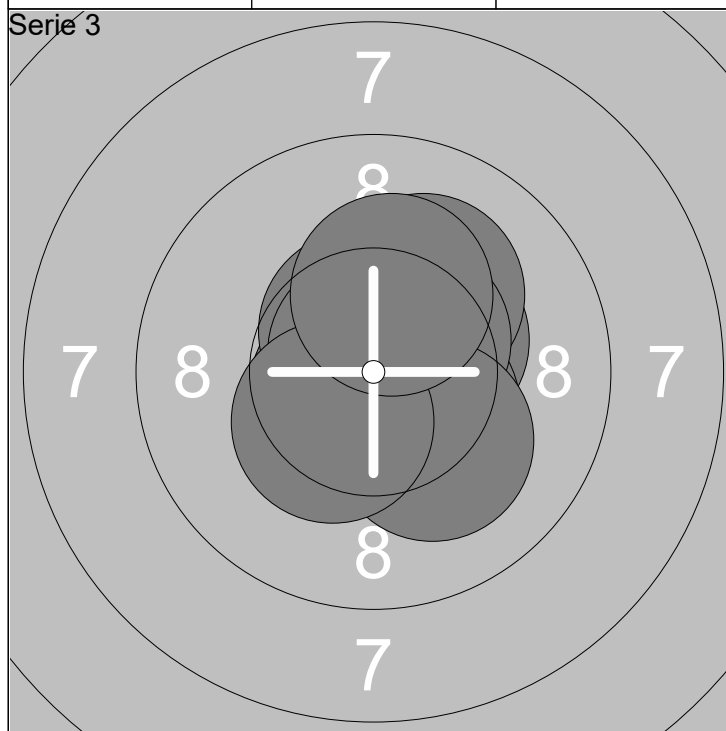

21: 10.7x ↙	26: 10.5x ↗	Serie	100
22: 10.4x ↗	27: 10.8x ↑		
23: 10.6x ↑	28: 10.1 ↓	Total	297
24: 10.5x ↘	29: 10.4x ↙		
25: 10.2x ↗	30: 10.3x ↑		

31: 10.0 ↓	36: 10.6x ↑	Serie	100
32: 10.4x ←	37: 10.3x ↙		
33: 10.2x ↑	38: 10.6x ↑	Total	397
34: 10.7x ←	39: 10.5x ↗		
35: 10.1 ↗	40: 10.6x ➔		

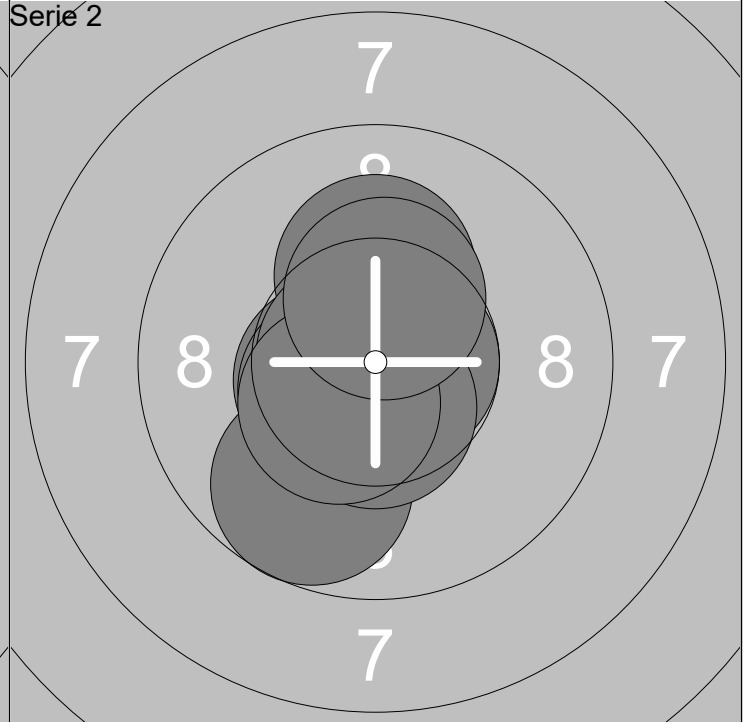
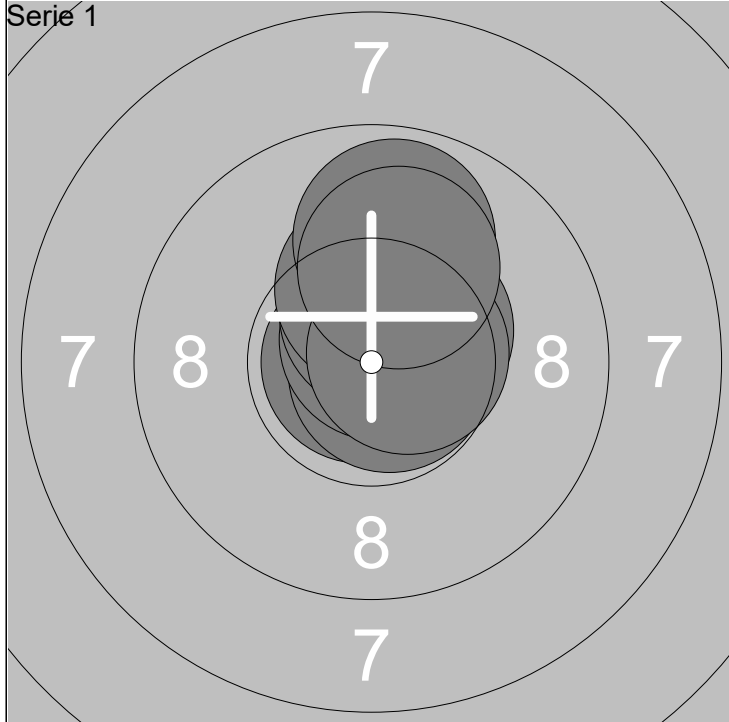

1: 10.9x ←	6: 10.5x ↑	Serie	99
2: 10.8x →	7: 10.3x ↑		Total
3: 10.7x ↑	8: 10.6x →		
4: 10.5x ↗	9: 9.9 ↑		
5: 10.3x ↑	10: 10.1 ↑		

11: 10.5x ←	16: 10.5x ↙	Serie	99
12: 10.7x →	17: 10.8x ←		Total
13: 10.5x ↓	18: 10.5x ↓		
14: 10.2x ↑	19: 10.5x ↙		
15: 9.7 ↓	20: 10.4x ↑		

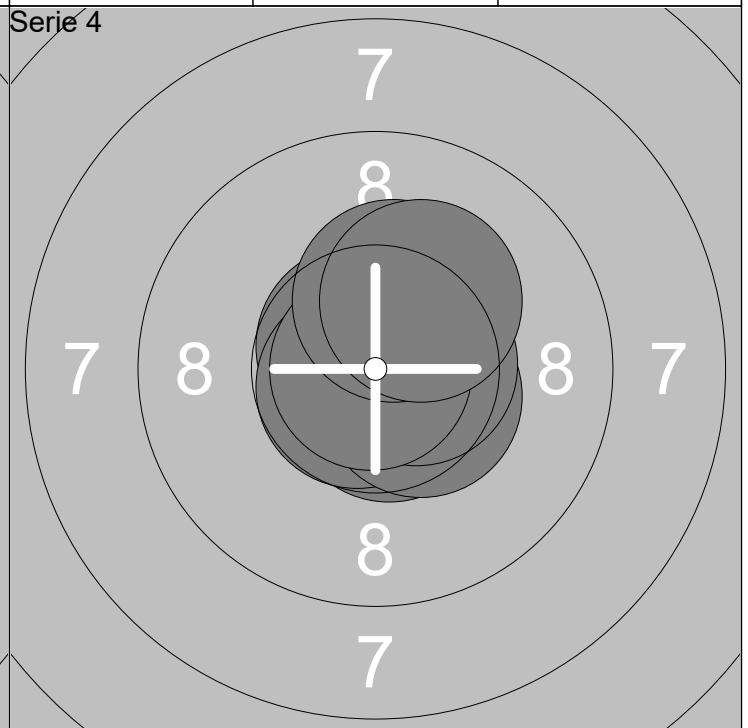
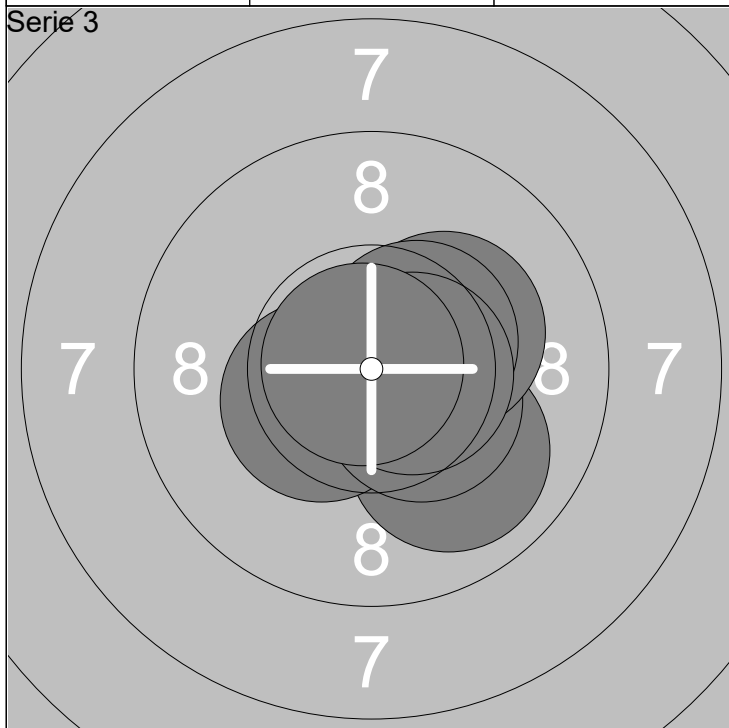

21: 10.8x ↙	26: 10.5x ↘	Serie	99
22: 10.9x ↘	27: 10.3x ↗		Total
23: 9.9 ↘	28: 10.5x ↗		
24: 10.9x ↓	29: 10.6x →		
25: 10.4x ↙	30: 10.9x ↖		

31: 10.5x ↑	36: 10.9x ↗	Serie	100
32: 10.6x ↓	37: 10.6x →		Total
33: 10.7x ↖	38: 10.9x ←		
34: 10.7x ↙	39: 10.3x ↑		
35: 10.5x ↘	40: 10.2x ↗		

Rottne Industri Cup 2018

Älgåhult

Mini

27.10.2018

Rottne Industri Cup 2018

Söraby SKF

Serie 1

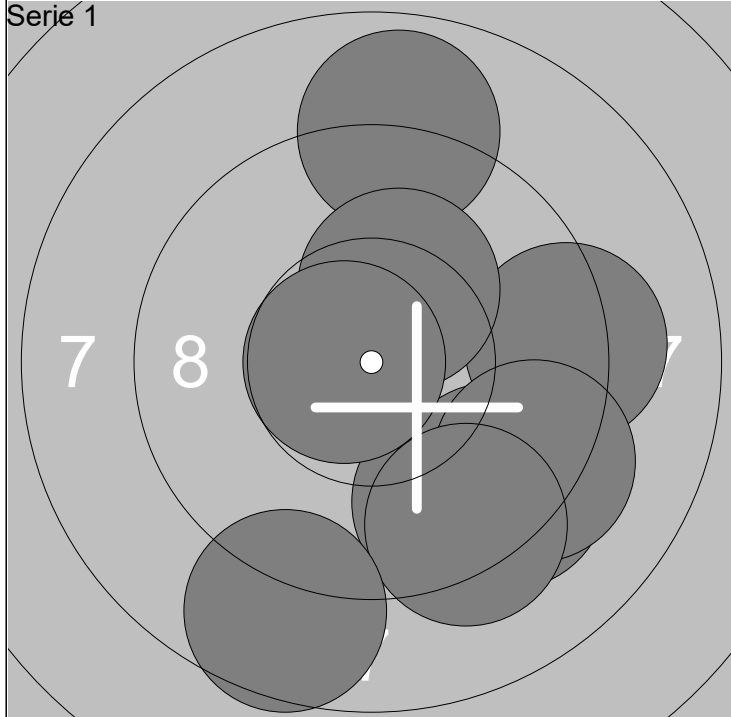

1: 9.2 →
2: 8.9 ↑
3: 9.3 ↓
4: 10.3x ↑
5: 9.5 ↓

6: 9.4 ↓
7: 10.7x ←
8: 9.3 ↓
9: 9.3 ↓
10: 8.6 ↓

Serie 90

Total 90

Serie 2

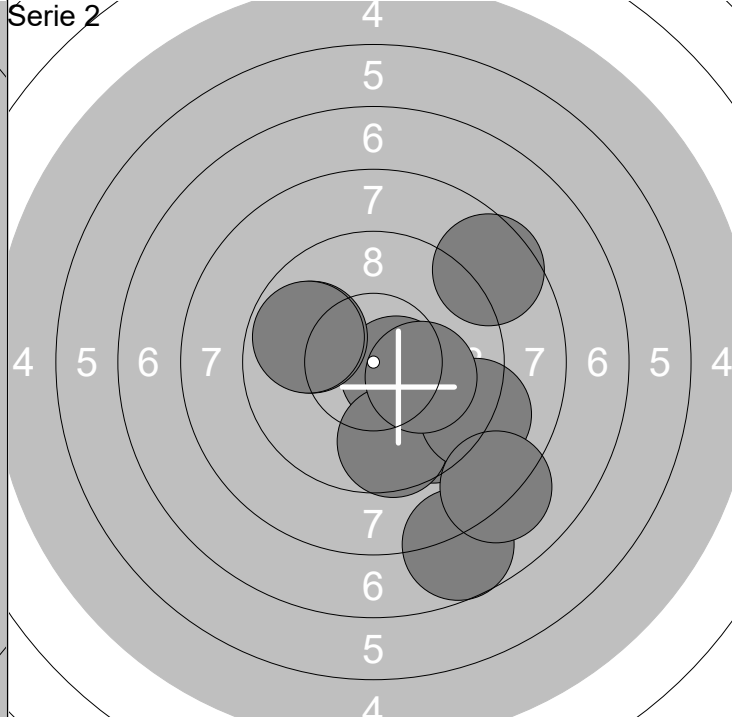

11: 10.6x →
12: 9.5 ↓
13: 9.6 ↓
14: 9.9 ↖
15: 9.8 ↖

16: 9.1 ↓
17: 7.7 ↓
18: 8.1 ↓
19: 10.2x →
20: 8.6 ↗

Serie 88

Total 178

Serie 3

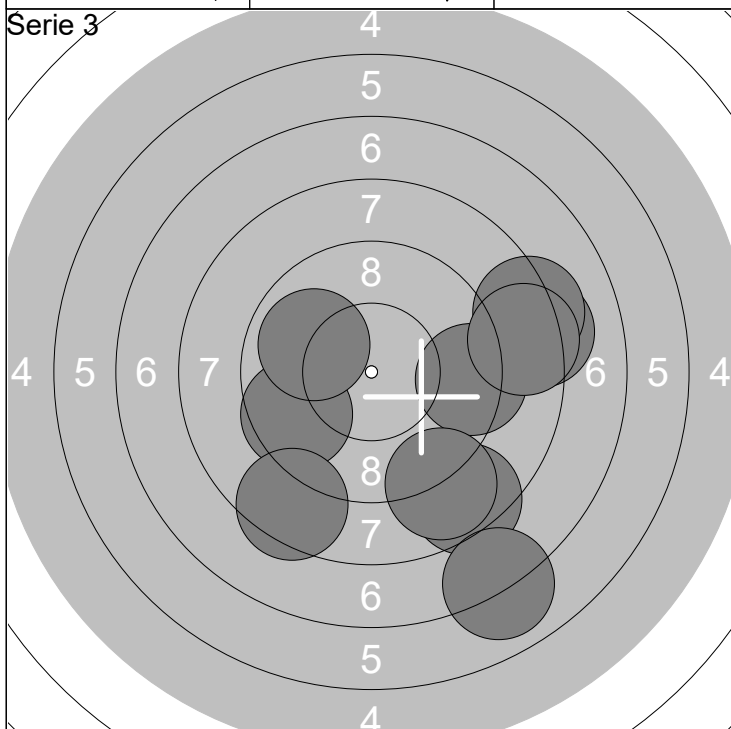

21: 8.2 →
22: 9.3 →
23: 8.4 ↓
24: 9.6 ←
25: 8.3 →

26: 8.5 →
27: 8.5 ↓
28: 8.9 ↓
29: 9.9 ↗
30: 7.0 ↓

Serie 82

Total 260

Serie 4

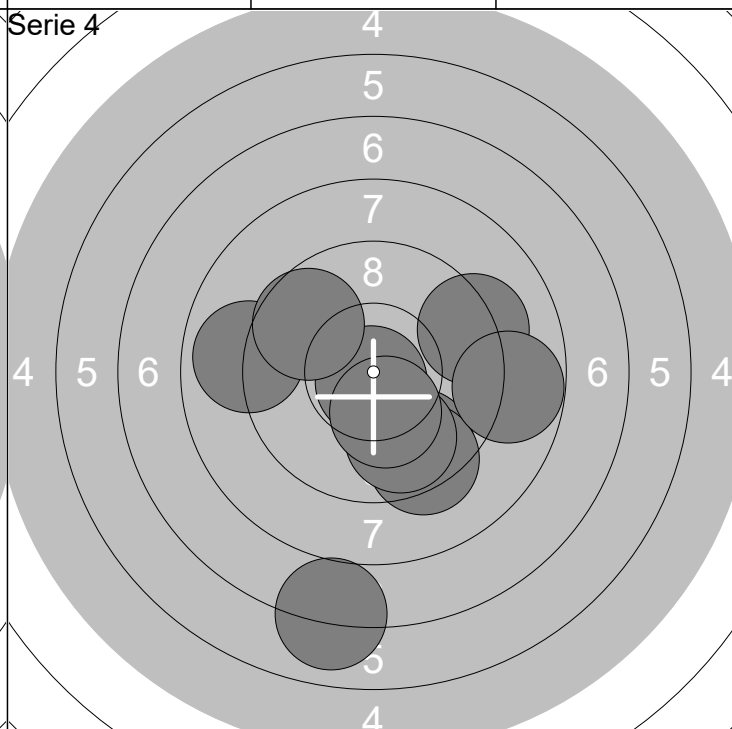

31: 9.6 ↓
32: 7.0 ↓
33: 9.3 ↓
34: 10.8x ↓
35: 9.2 →

36: 8.9 ←
37: 8.8 →
38: 9.7 ↗
39: 9.8 ↓
40: 10.3x ↓

Serie 88

Total 348

Rottne Industri Cup 2018

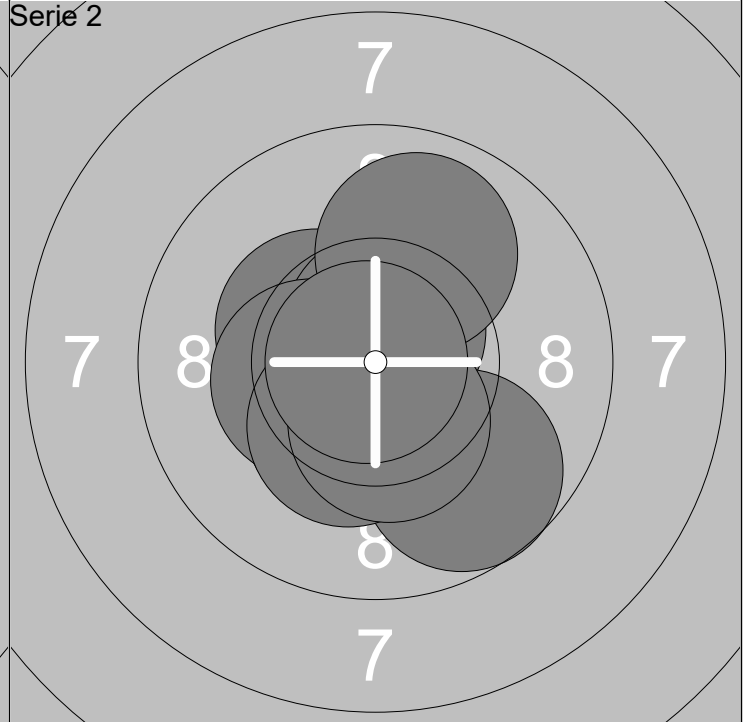
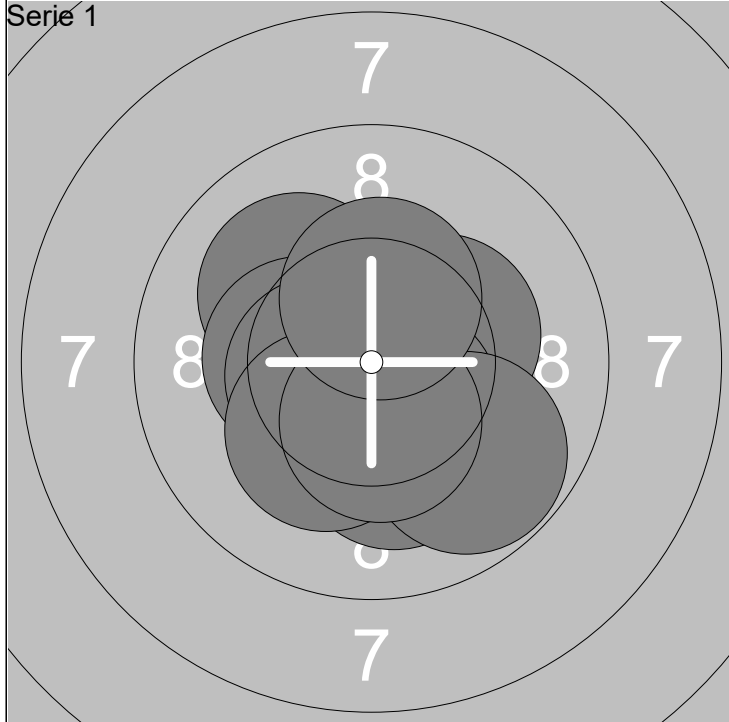

1: 10.3x →	6: 10.5x ←	Serie	99
2: 10.2x ↓	7: 9.8 ↓		
3: 10.1 ↗	8: 10.2x ↓	Total	99
4: 10.5x ↓	9: 10.4x ↓		
5: 10.4x ←	10: 10.4x ↑		

11: 10.6x ↗	16: 10.4x ←	Serie	98
12: 10.4x ↓	17: 10.3x ↓		
13: 10.4x ↖	18: 10.4x ↓	Total	197
14: 10.7x ↑	19: 9.9 ↑		
15: 9.7 ↓	20: 10.9x ←		

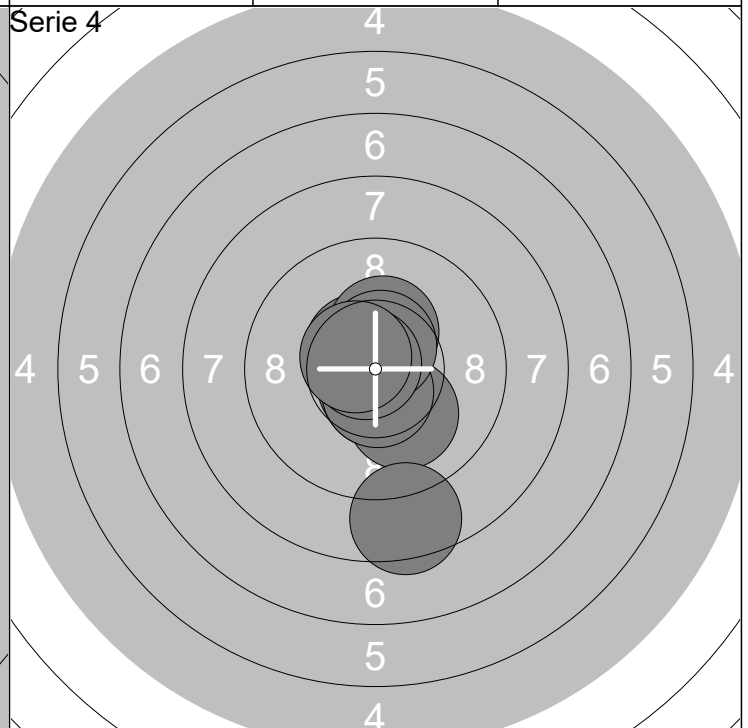
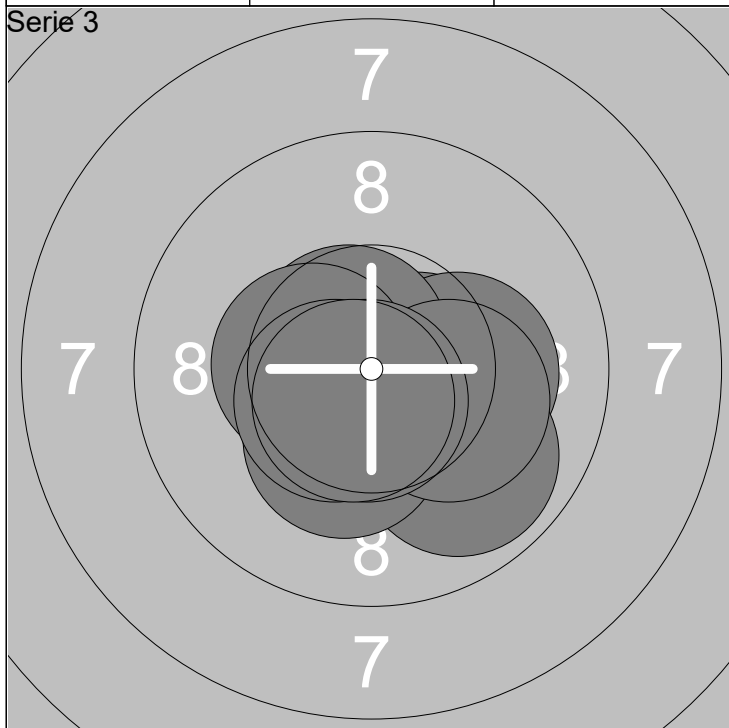

21: 10.6x →	26: 10.3x ↓	Serie	99
22: 10.2x →	27: 10.2x →		
23: 10.7x ↗	28: 10.5x ↖	Total	296
24: 10.4x ←	29: 10.7x ↓		
25: 9.9 ↓	30: 10.6x ↓		

31: 10.6x ↓	36: 10.6x ↓	Serie	98
32: 10.1 ↓	37: 10.3x ↑		
33: 10.6x ↗	38: 10.6x ↑	Total	394
34: 10.7x ↓	39: 10.7x ↖		
35: 8.5 ↓	40: 10.6x ↗		

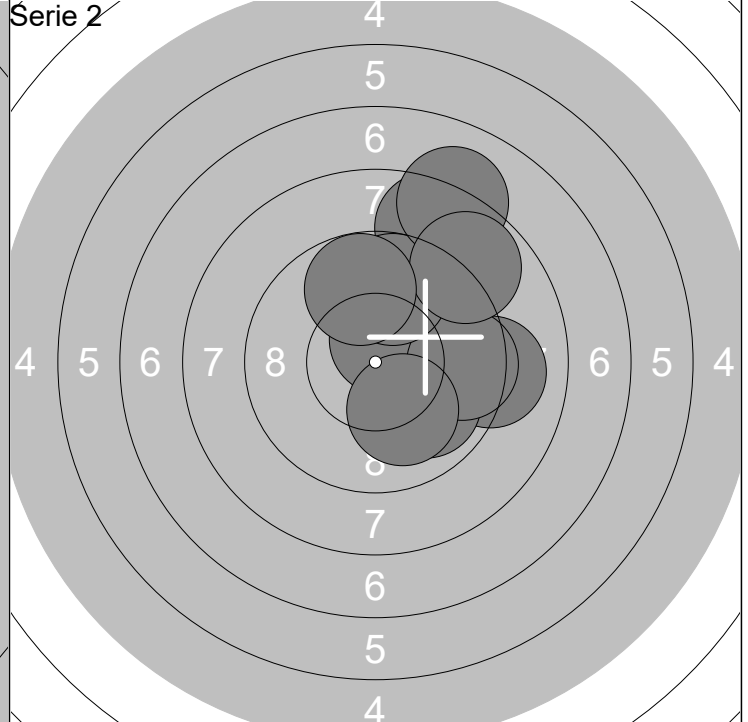
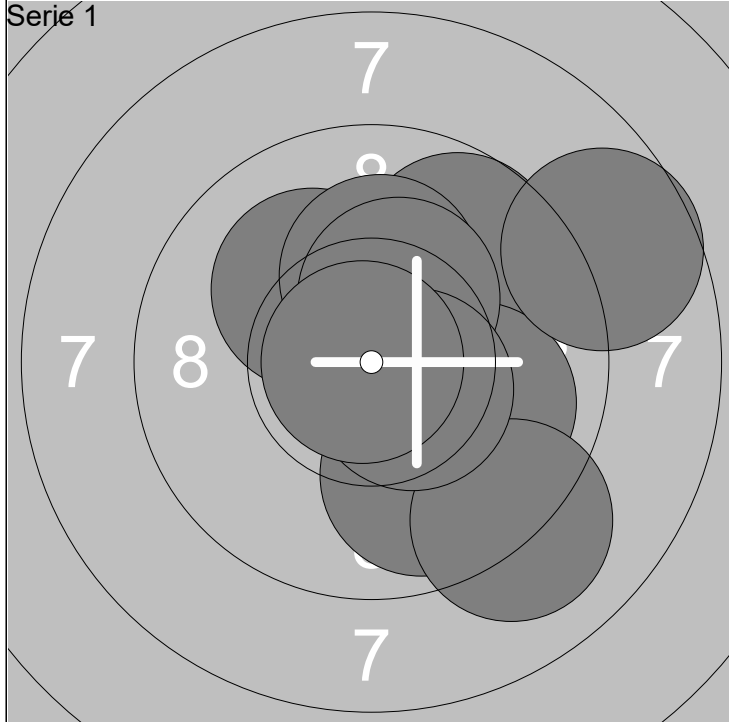

1: 9.9 ↘	6: 10.2x ↑	Serie	95
2: 10.1 ↗	7: 8.7 →		
3: 9.7 ↗	8: 10.3x ↑	Total	95
4: 10.0 →	9: 10.5x ↘		
5: 9.1 ↘	10: 10.9x ←		

11: 9.1 →	16: 9.8 ↑	Serie	89
12: 9.9 ↘	17: 8.1 ↗		
13: 10.6x ↑	18: 8.8 ↗	Total	184
14: 8.6 ↑	19: 9.8 ↑		
15: 9.6 →	20: 10.1 ↘		

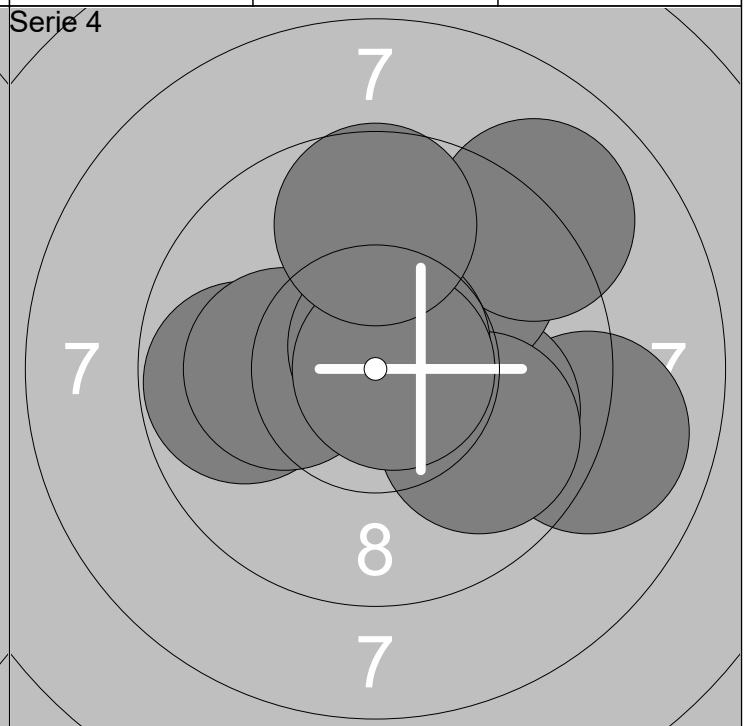
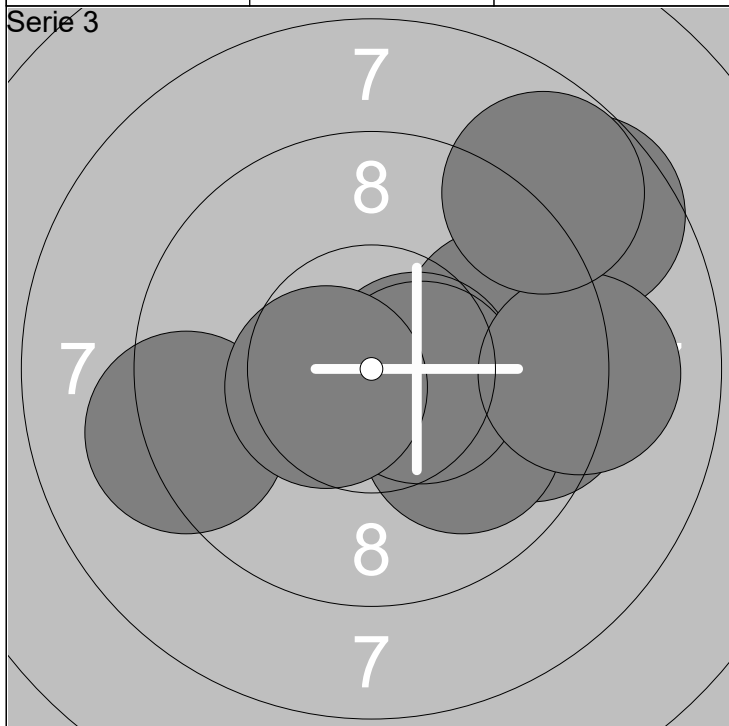

21: 9.5 →	26: 10.5x →	Serie	92
22: 8.6 ↗	27: 9.1 →		
23: 10.0 ↘	28: 9.2 ←	Total	276
24: 9.7 →	29: 10.5x ←		
25: 10.5x →	30: 8.8 ↗		

31: 9.8 ←	36: 9.8 ↘	Serie	94
32: 9.0 →	37: 9.0 ↗		
33: 10.1 ←	38: 10.7x ↑	Total	370
34: 10.0 →	39: 10.8x →		
35: 9.9 ↗	40: 9.7 ↑		

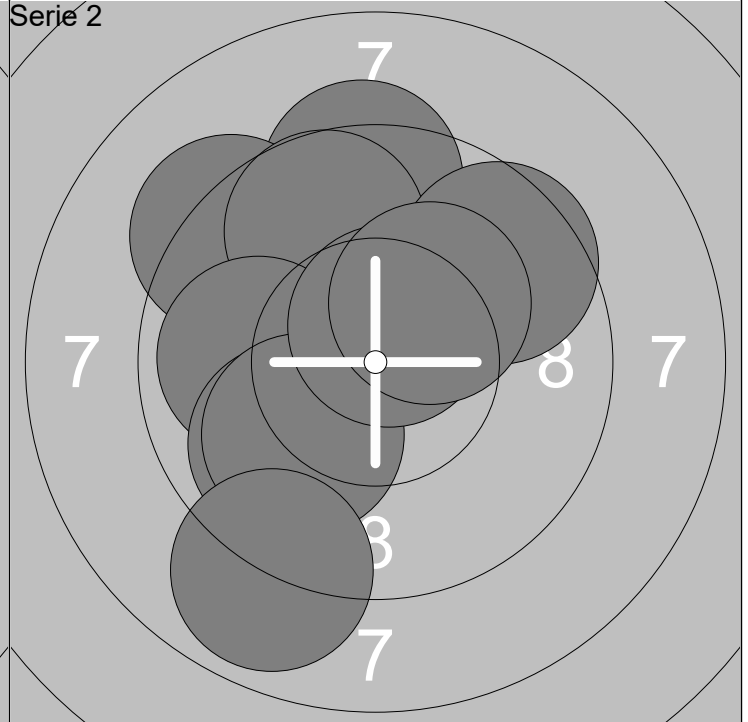
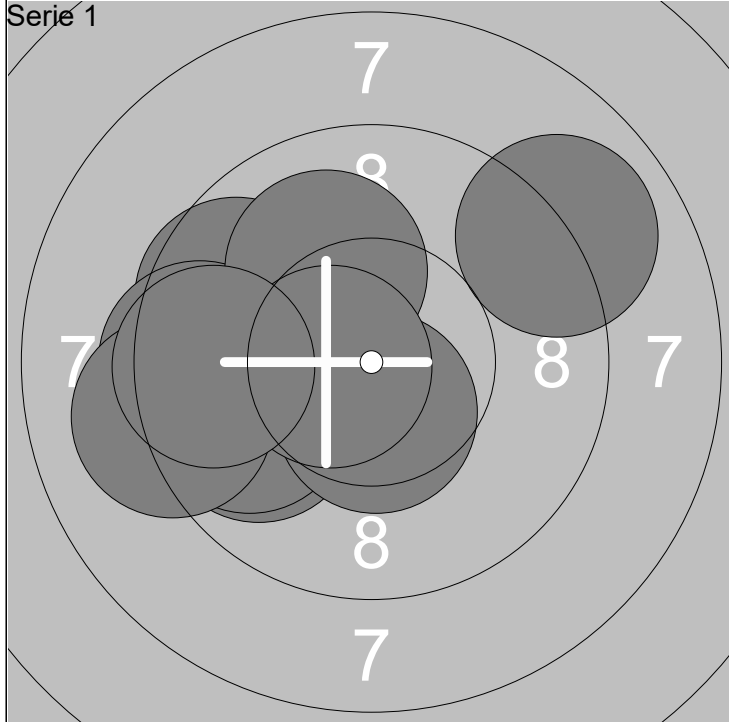

1: 9.6 ↖	6: 9.0 ↗	Serie	93
2: 9.8 ↖	7: 10.5x ↓		
3: 9.4 ←	8: 10.1 ↗	Total	93
4: 9.8 ↖	9: 10.6x ←		
5: 9.1 ←	10: 9.5 ←		

11: 9.4 ↑	16: 9.9 ↙	Serie	92
12: 9.2 ↖	17: 10.1 ↙		
13: 9.7 ↑	18: 10.6x ↑	Total	185
14: 9.9 ←	19: 8.9 ↙		
15: 9.6 ↗	20: 10.3x ↗		

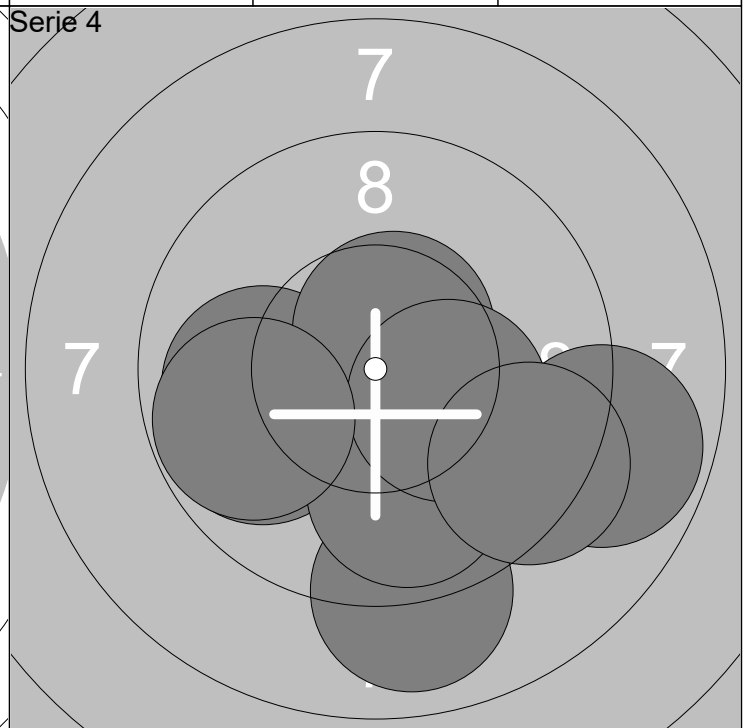
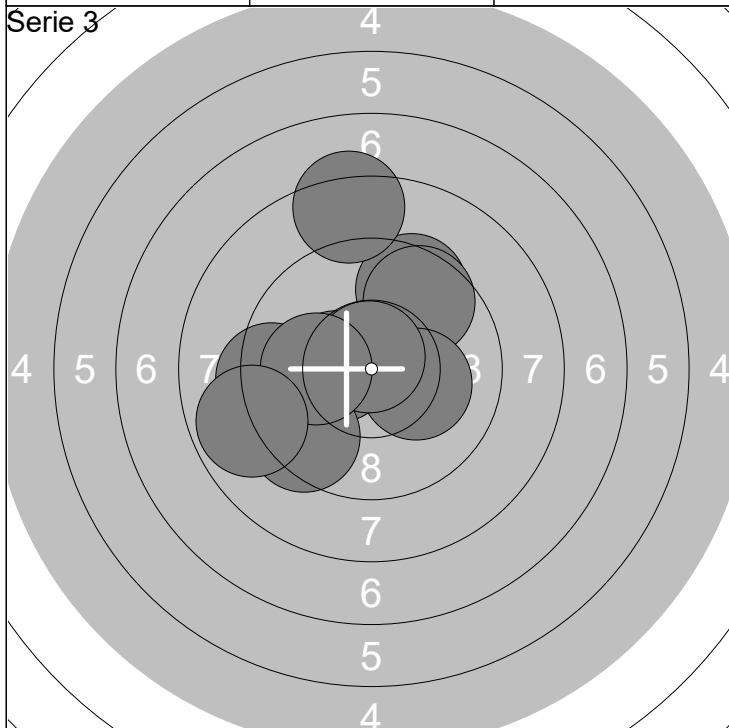

21: 9.5 ↗	26: 9.3 ←	Serie	92
22: 9.6 ↗	27: 9.4 ↙		
23: 10.2x →	28: 10.1 ←	Total	277
24: 10.4x ←	29: 8.9 ←		
25: 10.7x ↑	30: 8.3 ↑		

31: 9.9 ←	36: 10.6x ↗	Serie	92
32: 10.6x ↙	37: 8.8 →		
33: 9.9 ↖	38: 10.3x →	Total	369
34: 9.0 ↓	39: 9.4 ↙		
35: 9.9 ↓	40: 9.8 ←		

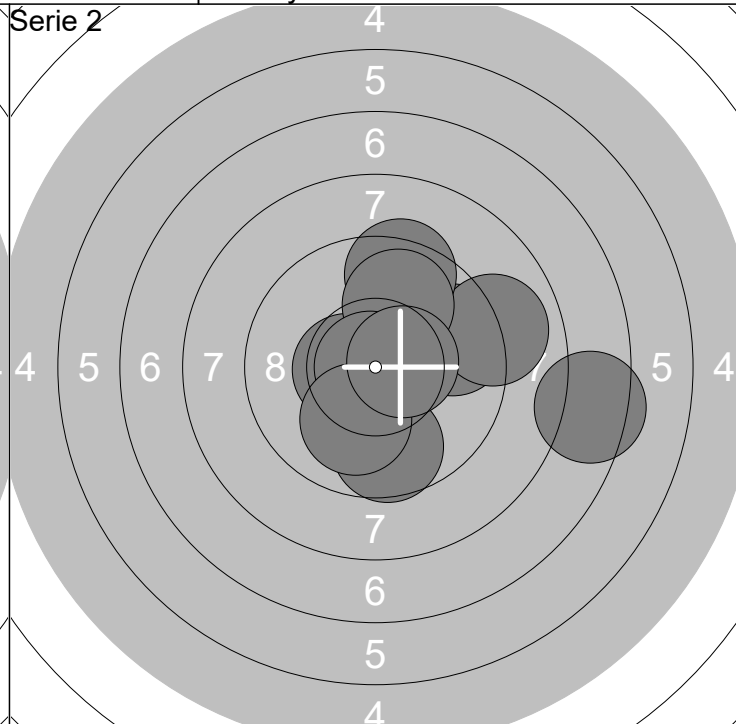
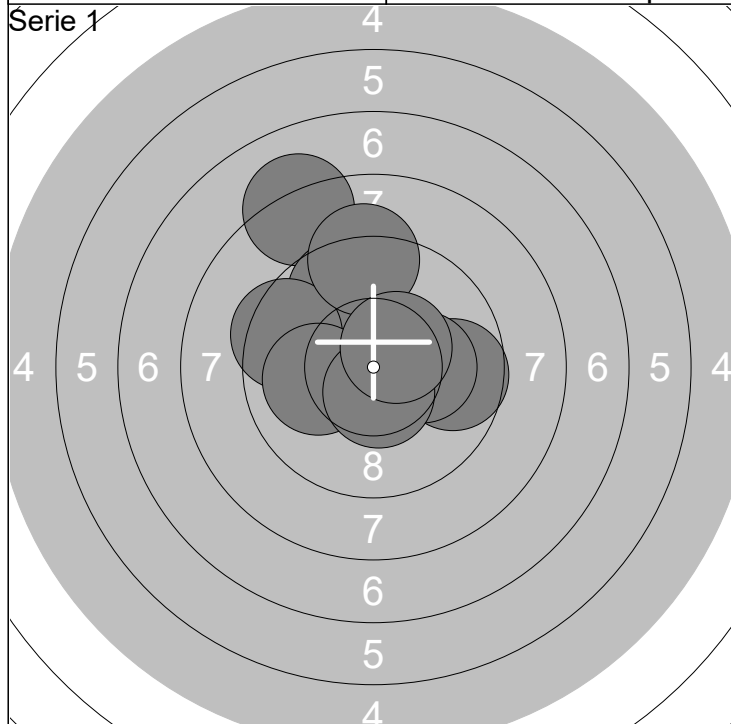

1: 8.2 ↗	6: 9.2 ↑	Serie	94
2: 9.7 →	7: 10.0 ←		
3: 9.7 ↗	8: 10.2x →	Total	94
4: 10.6x →	9: 10.6x ↓		
5: 9.4 ←	10: 10.4x ↗		

11: 10.5x ←	16: 9.9 ↗	Serie	92
12: 9.6 →	17: 9.7 ↓		
13: 7.5 →	18: 10.9x ←	Total	186
14: 9.0 →	19: 10.0 ↓		
15: 9.4 ↑	20: 10.5x →		

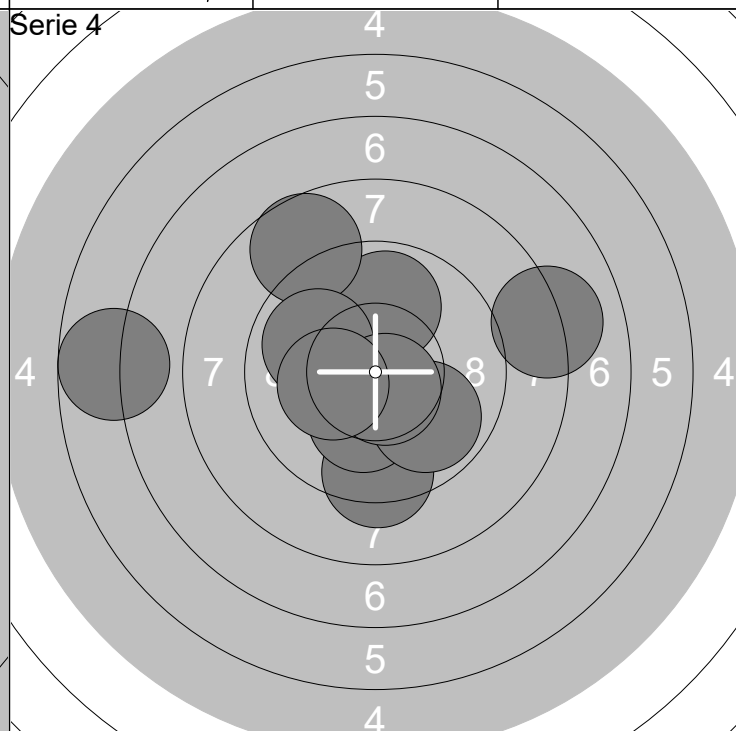
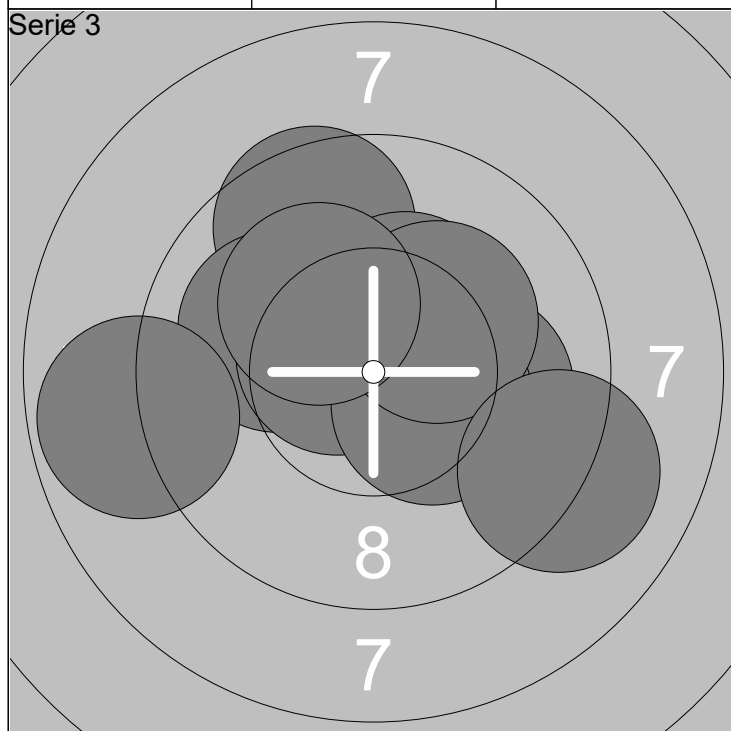

21: 10.1 →	26: 8.8 ←	Serie	96
22: 9.6 ↗	27: 10.3x ↘		
23: 10.0 ←	28: 10.3x ↗	Total	282
24: 10.6x ↖	29: 9.1 ↘		
25: 10.4x ↗	30: 10.2x ↗		

31: 8.1 →	36: 9.9 ↖	Serie	88
32: 9.3 ↓	37: 9.9 ↘		
33: 9.9 ↑	38: 10.6x ↘	Total	370
34: 8.7 ↗	39: 6.8 ←		
35: 10.2x ↓	40: 10.3x ←		

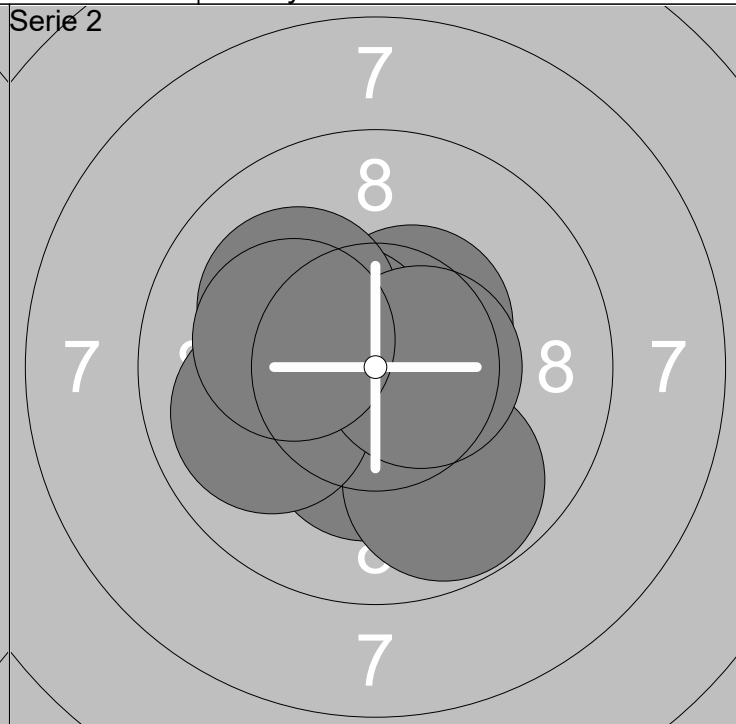
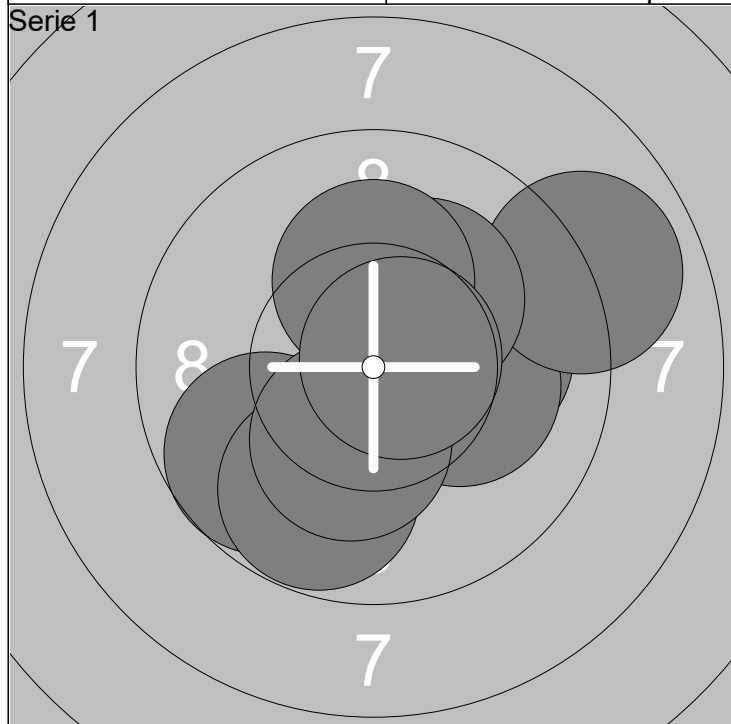

1: 10.5x ↗	6: 9.8 ↓	Serie	96
2: 10.1 →	7: 10.2x ↗		
3: 10.2x →	8: 10.2x ↑	Total	96
4: 8.9 →	9: 10.3x ↓		
5: 9.7 ↙	10: 10.7x →		

11: 10.6x ↓	16: 9.8 ↓	Serie	98
12: 10.3x ↓	17: 10.1 ↗		
13: 10.5x ↗	18: 9.9 ←	Total	194
14: 10.8x ↓	19: 10.6x →		
15: 10.6x ↖	20: 10.2x ←		

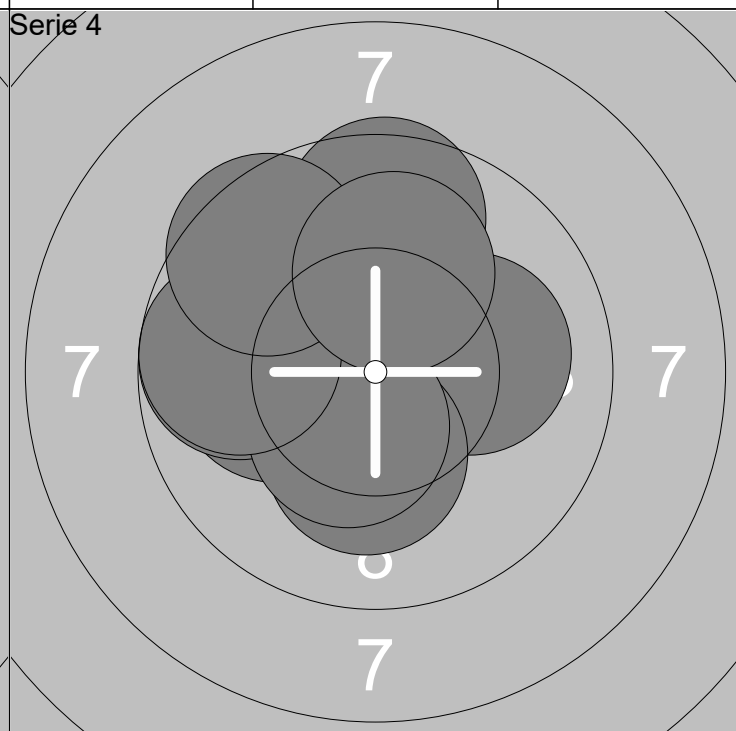
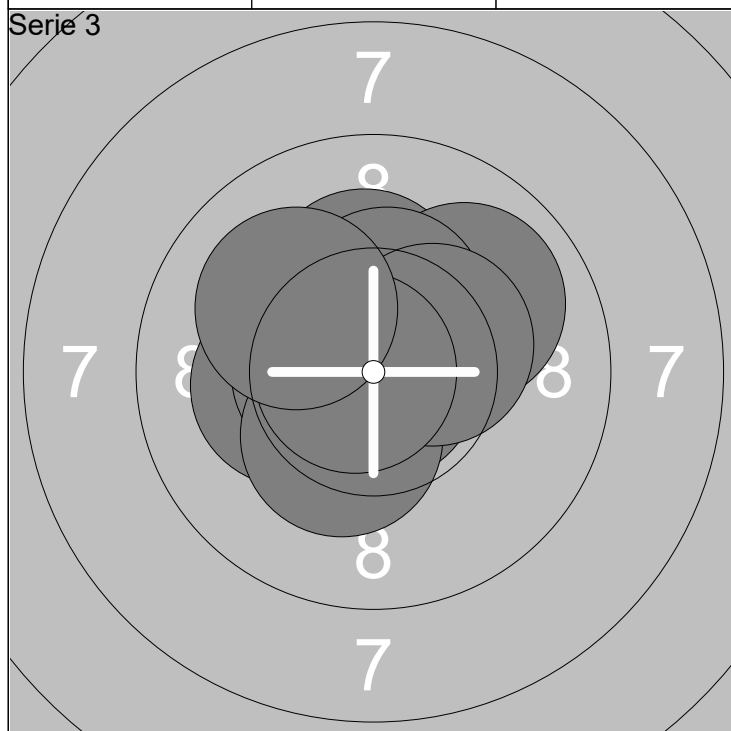

21: 10.9x ↓	26: 10.6x ←	Serie	99
22: 10.2x ↑	27: 10.3x ↓		
23: 10.2x ←	28: 10.4x →	Total	293
24: 9.9 ↗	29: 10.8x ←		
25: 10.4x ↑	30: 10.1 ↖		

31: 10.1 →	36: 10.4x ↓	Serie	96
32: 10.1 ←	37: 9.6 ↑		
33: 10.3x ↗	38: 9.7 ←	Total	389
34: 9.8 ←	39: 9.5 ↖		
35: 10.2x ↓	40: 10.0 ↑		

Serie 1

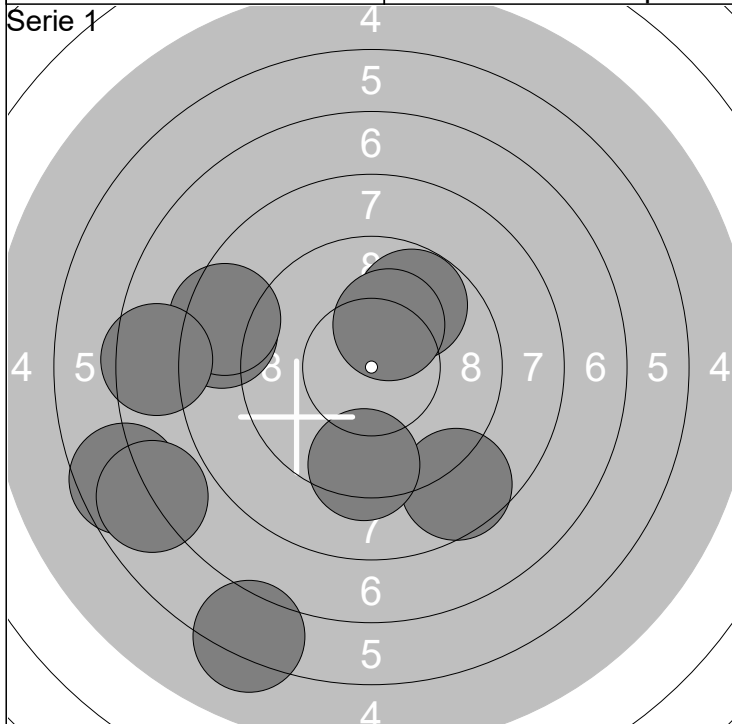

Serie 2

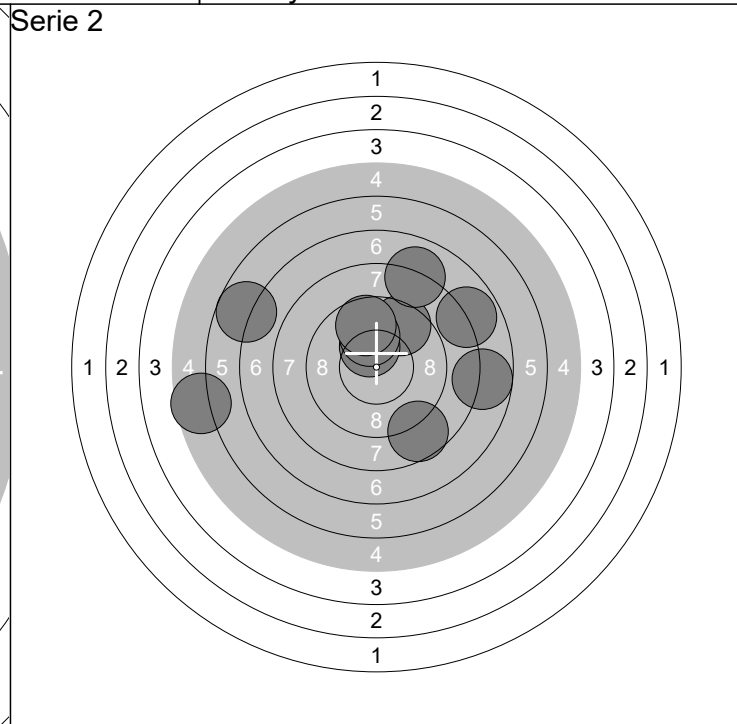

1: 6.6 ←	6: 8.5 ←	Serie	77
2: 6.2 ↓	7: 10.2x ↑		
3: 9.8 ↗	8: 6.9 ←	Total	77
4: 8.6 ↓	9: 9.4 ↓		
5: 8.5 ←	10: 7.5 ←		

11: 7.9 ↗	16: 10.3x ↑	Serie	79
12: 6.8 ←	17: 10.0 ↑		
13: 8.7 ↓	18: 9.7 ↑	Total	156
14: 9.5 ↗	19: 8.0 ↑		
15: 7.8 →	20: 5.6 ←		

Serie 3

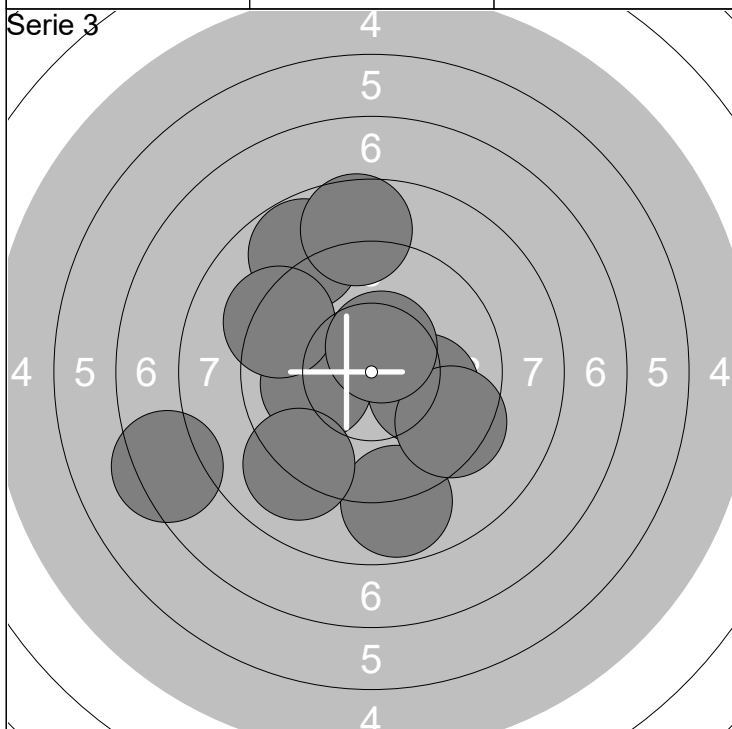

Serie 4

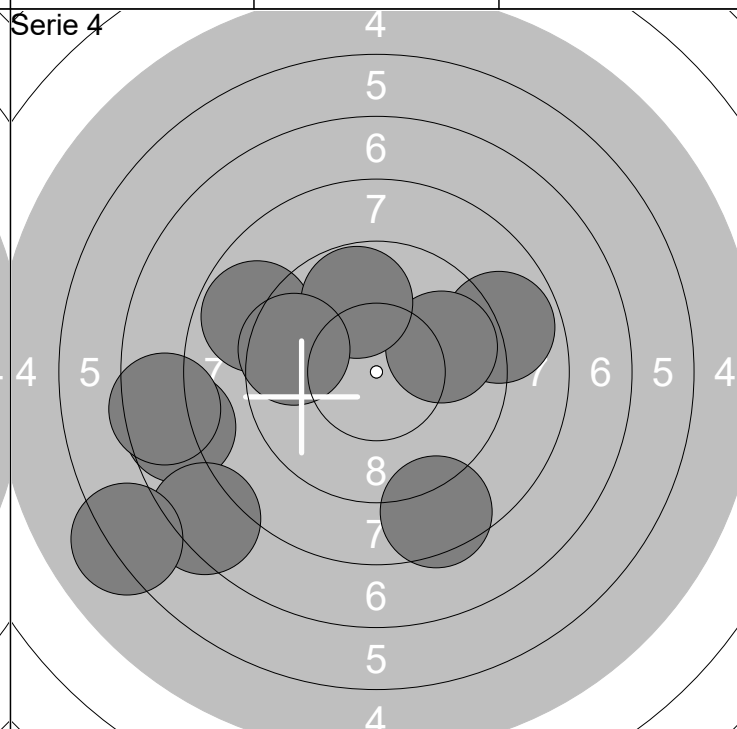

21: 7.4 ←	26: 10.0 ←	Serie	88
22: 10.1 →	27: 9.1 ↓		
23: 8.8 ↓	28: 9.4 ↓	Total	244
24: 8.8 ↗	29: 9.3 ←		
25: 8.7 ↑	30: 10.5x ↑		

31: 8.9 →	36: 7.3 ←	Serie	78
32: 7.7 ←	37: 7.5 ←		
33: 8.8 ←	38: 9.8 ↑	Total	322
34: 8.5 ↓	39: 6.1 ←		
35: 9.8 →	40: 9.6 ←		

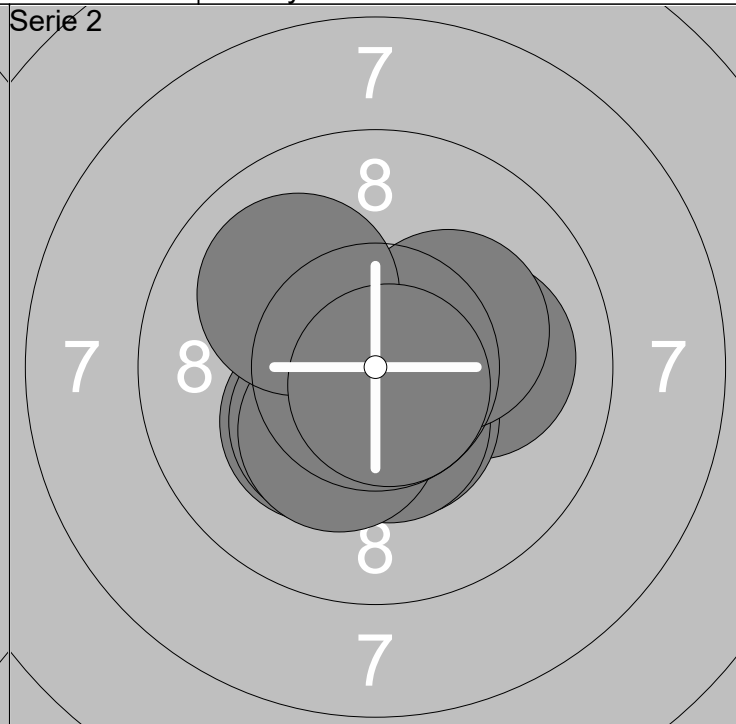
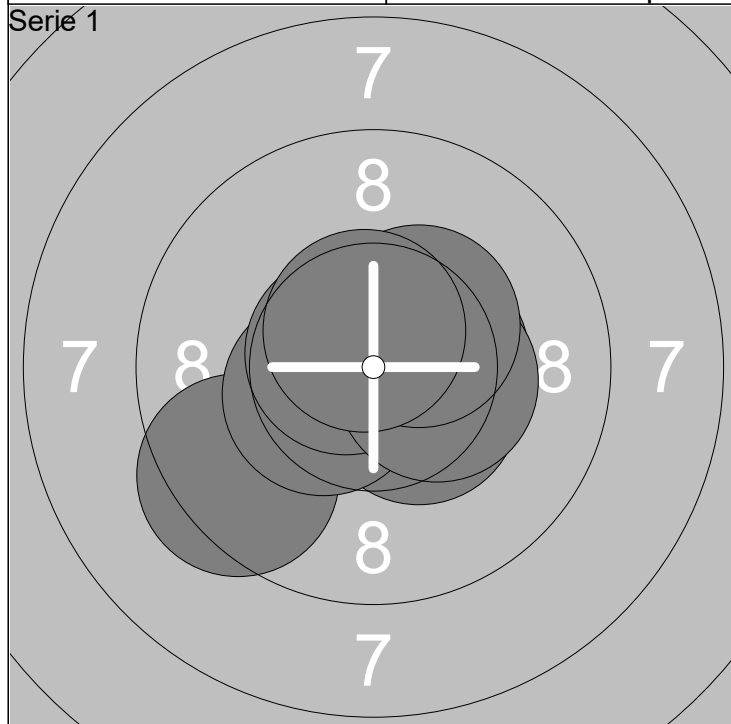

1: 10.5x ↘	6: 10.7x ↗	Serie	99
2: 9.4 ↙	7: 10.7x ↖		
3: 10.8x ↖	8: 10.4x →	Total	99
4: 10.5x →	9: 10.4x ↗		
5: 10.5x ↙	10: 10.6x ↗		

11: 10.3x ↙	16: 10.2x ↗	Serie	100
12: 10.7x ↖	17: 10.3x ↙		
13: 10.1 →	18: 10.3x ↙	Total	199
14: 10.5x ↘	19: 10.0 ↖		
15: 10.5x ↘	20: 10.7x ↘		

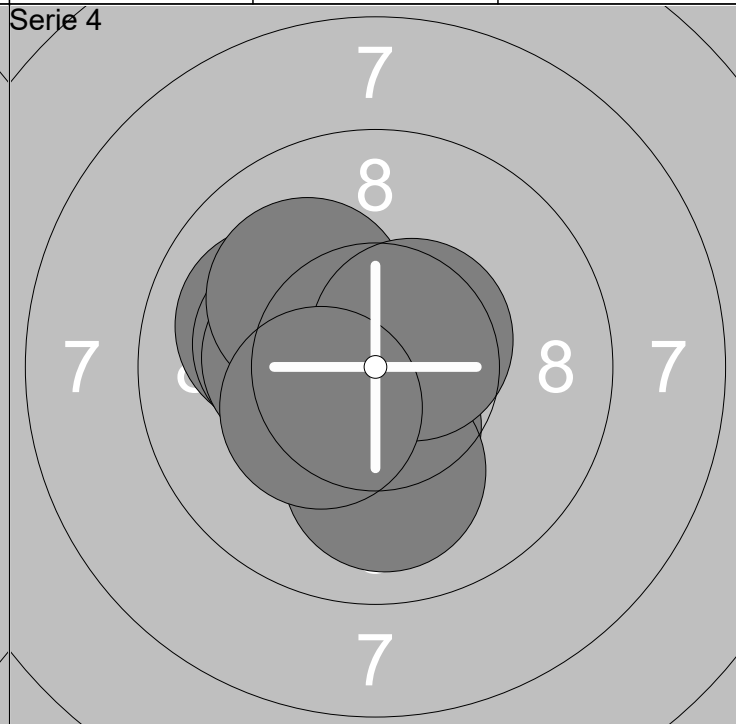
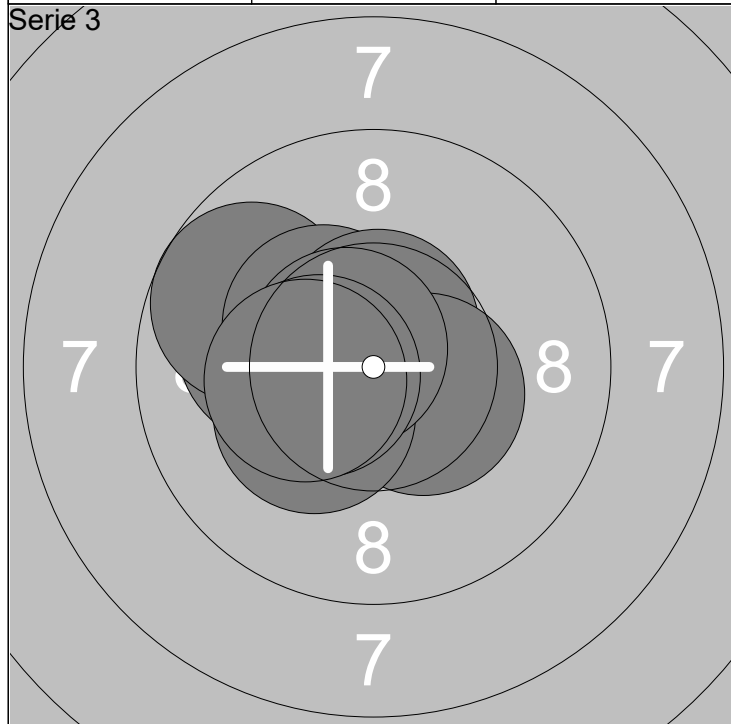

21: 10.1 ↖	26: 10.5x ↘	Serie	99
22: 9.8 ↖	27: 10.3x ↙		
23: 10.4x ↖	28: 10.7x ↖	Total	298
24: 10.6x ↗	29: 10.4x ↖		
25: 10.6x ↙	30: 10.3x ↖		

31: 10.4x ↘	36: 10.3x ↖	Serie	100
32: 10.0 ↖	37: 10.1 ↖		
33: 10.3x ↖	38: 10.0 ↘	Total	398
34: 10.8x ↘	39: 10.5x ↗		
35: 10.2x ↖	40: 10.3x ↙		

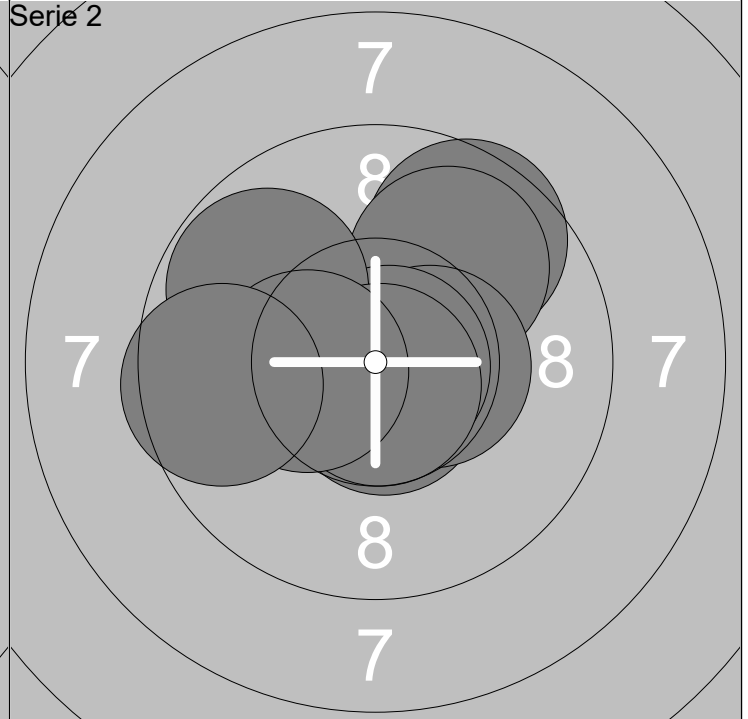
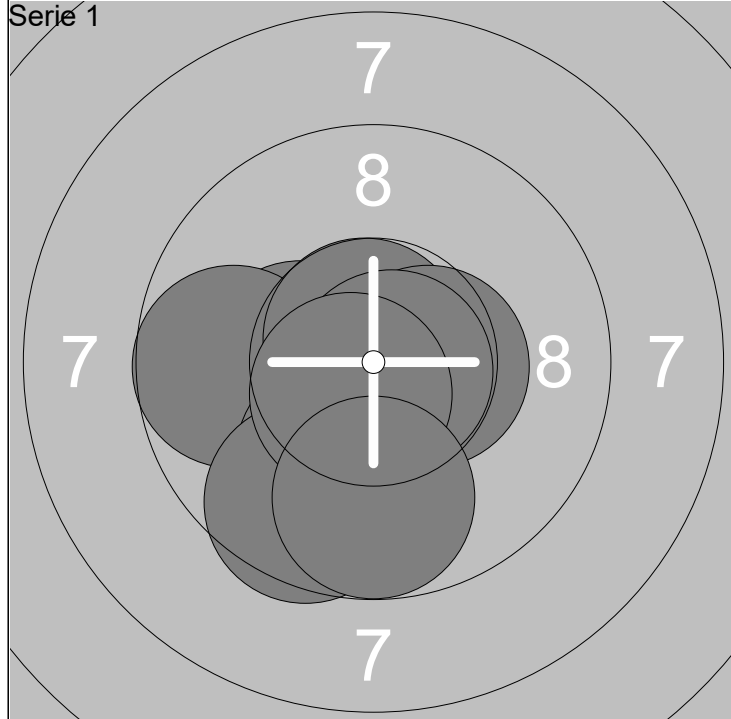

1: 10.2x ←	6: 10.0 ↓	Serie	97
2: 10.3x ←	7: 10.8x →		
3: 9.7 ←	8: 9.6 ↓	Total	97
4: 10.7x ↗	9: 10.6x ↘		
5: 10.5x →	10: 9.7 ↓		

11: 9.6 ↗	16: 10.8x →	Serie	96
12: 9.9 ↗	17: 9.8 ↖		
13: 10.7x ↓	18: 10.8x ↓	Total	193
14: 10.5x →	19: 10.4x ←		
15: 10.0 ←	20: 9.6 ←		

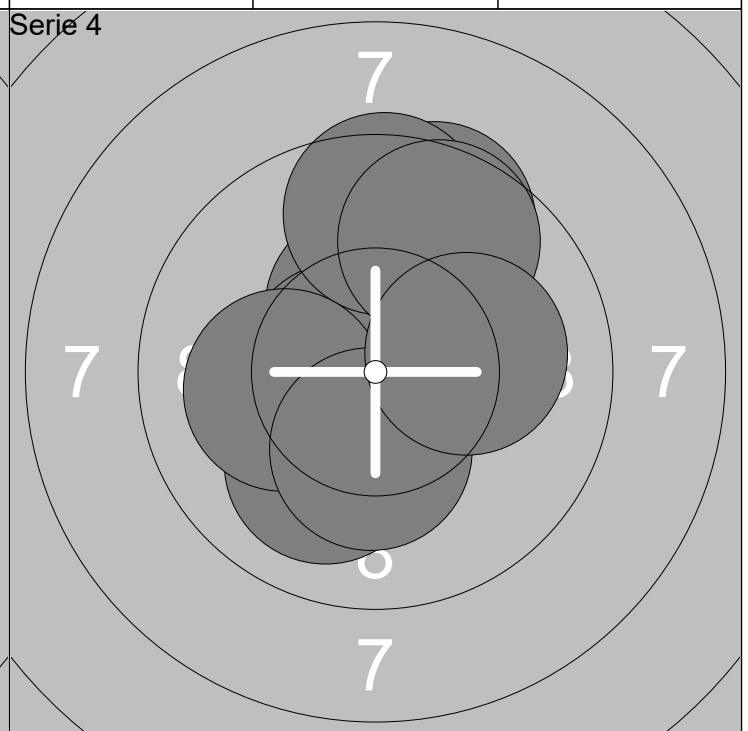
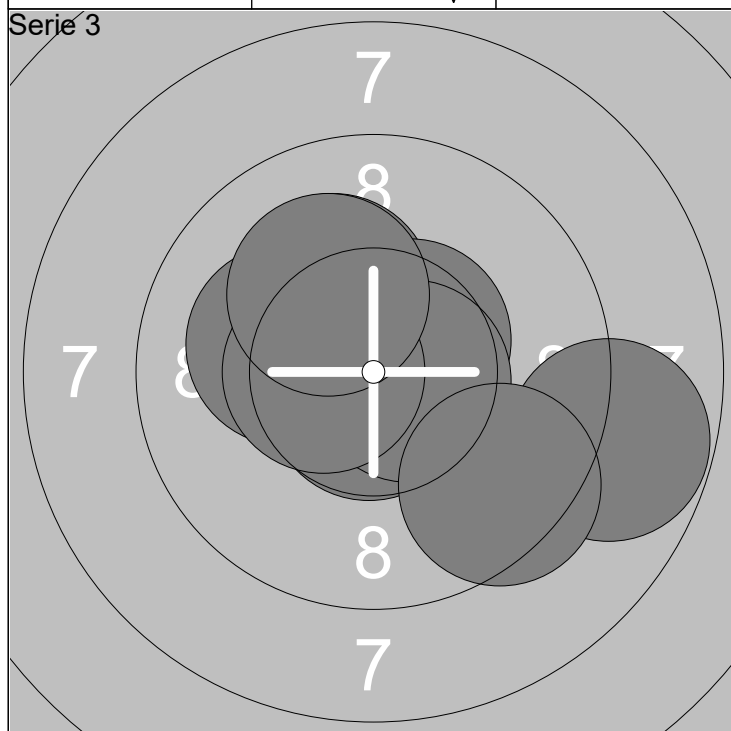

21: 10.2x ↗	26: 10.5x ↗	Serie	97
22: 10.2x ←	27: 10.6x →		
23: 8.8 →	28: 10.5x ←	Total	290
24: 10.8x ↓	29: 9.4 ↓		
25: 10.7x ↓	30: 10.2x ↗		

31: 10.3x ↓	36: 10.0 ↓	Serie	97
32: 10.4x ↑	37: 9.6 ↗		
33: 9.5 ↗	38: 10.1 ←	Total	387
34: 10.7x ←	39: 10.3x ↓		
35: 9.6 ↑	40: 10.1 →		

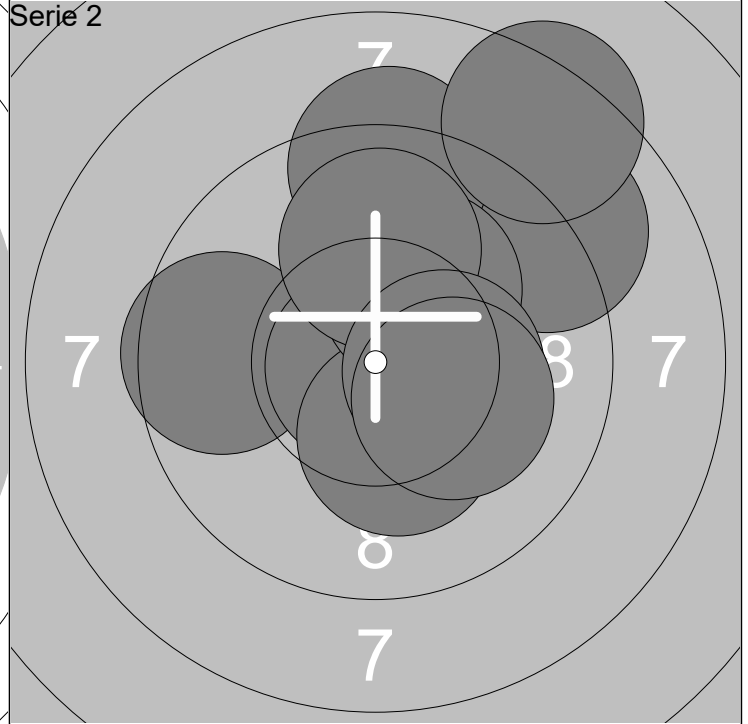
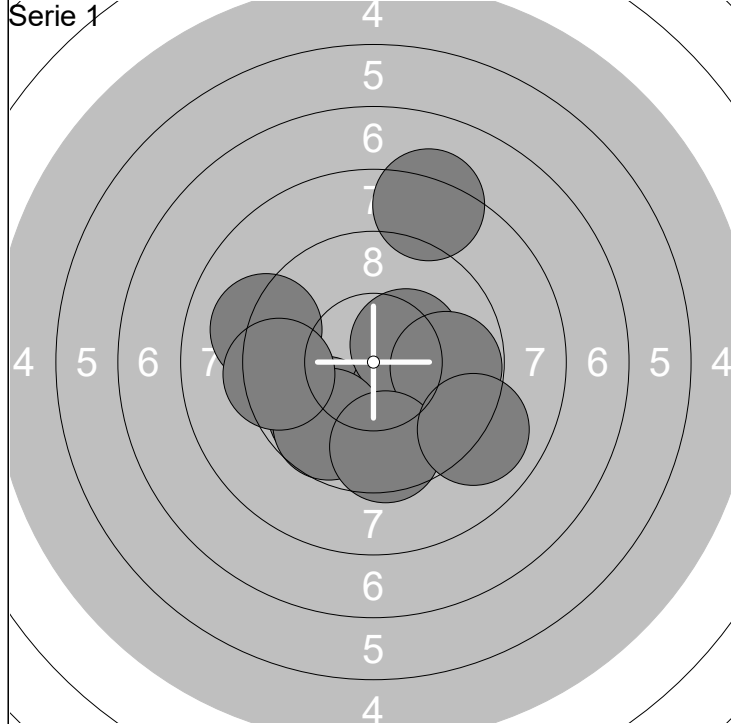

1: 9.2 ↙	6: 9.8 →	Serie	91
2: 9.8 ↘	7: 9.4 ←		
3: 10.2x ↘	8: 9.6 ↓	Total	91
4: 10.4x ↗	9: 9.0 ↘		
5: 9.7 ↘	10: 8.3 ↑		

11: 9.6 ←	16: 10.2x ↗	Serie	95
12: 10.9x ↙	17: 10.0 ↑		
13: 9.0 ↗	18: 8.4 ↗	Total	186
14: 10.3x ↓	19: 10.4x →		
15: 9.2 ↑	20: 10.2x ↘		

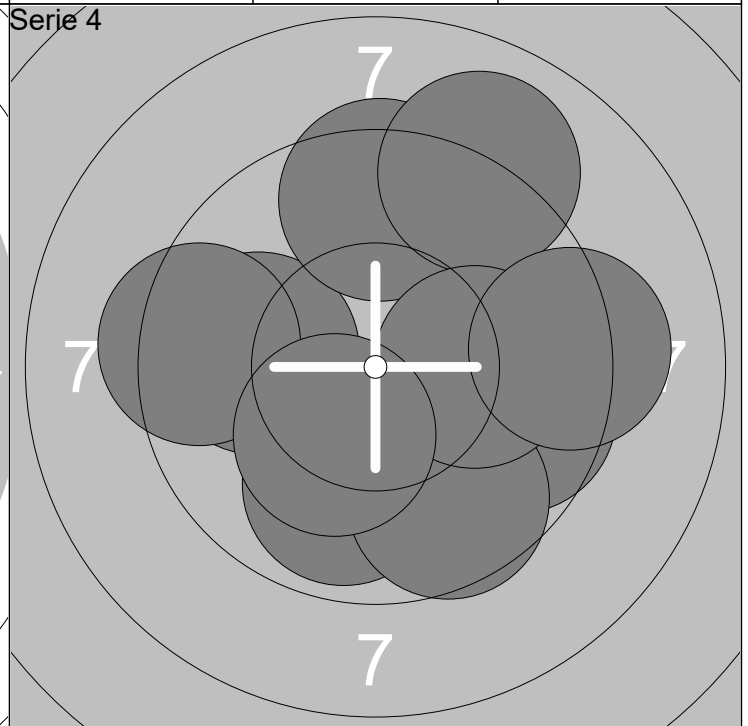
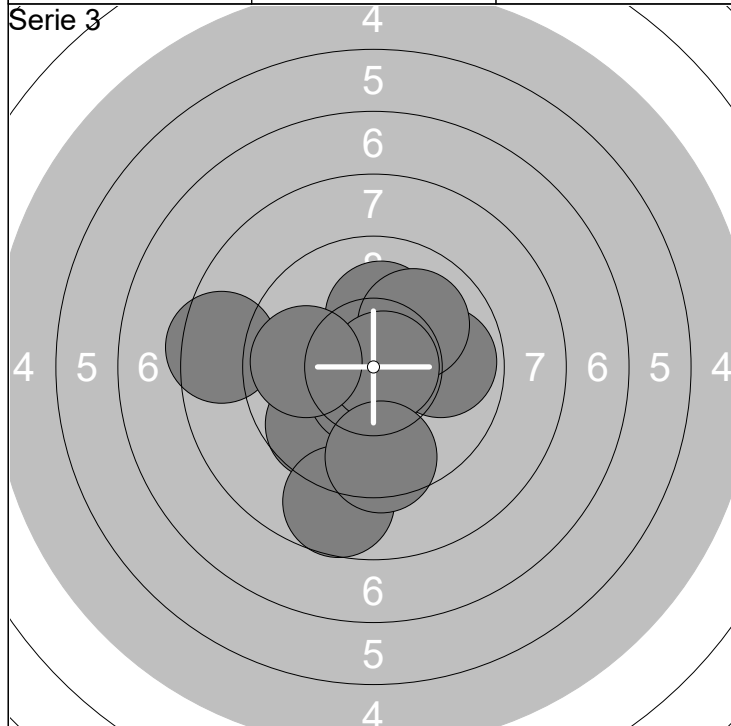

21: 9.7 ↘	26: 8.5 ←	Serie	92
22: 9.8 →	27: 10.0 ↗		
23: 8.7 ↓	28: 10.8x →	Total	278
24: 10.1 ↑	29: 9.5 ↓		
25: 10.6x ↘	30: 9.9 ←		

31: 9.9 ←	36: 9.9 ↓	Serie	92
32: 9.5 ↑	37: 9.6 ↓		
33: 9.4 ←	38: 10.1 →	Total	370
34: 9.0 ↗	39: 9.2 →		
35: 9.6 ↗	40: 10.2x ↘		

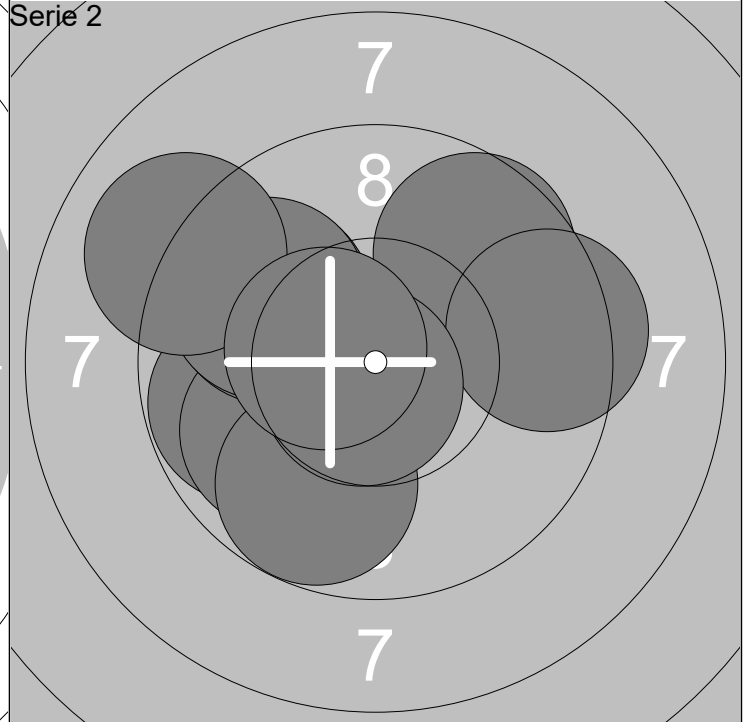
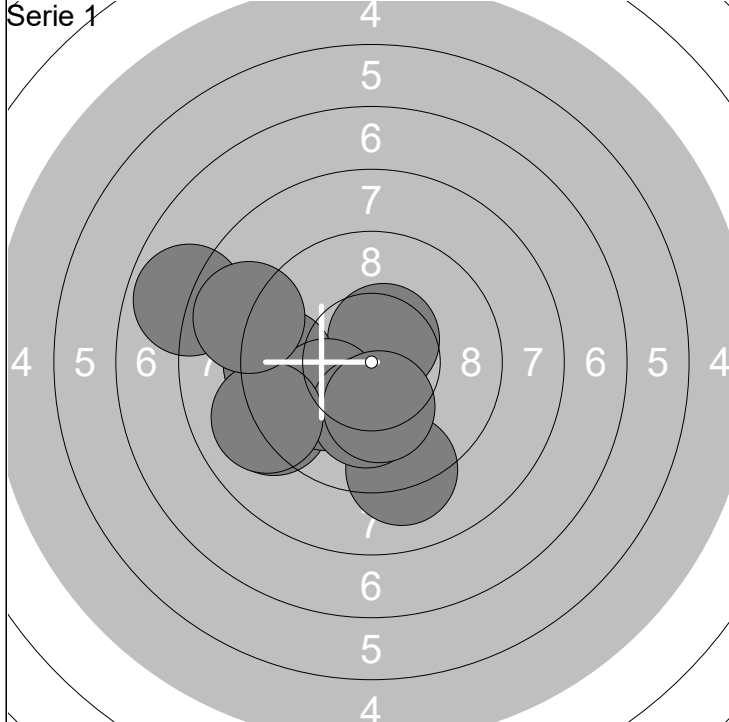

1: 10.5x ↗	6: 7.9 ←	Serie	91
2: 9.5 ←	7: 10.1 ↓		
3: 9.2 ↓	8: 9.1 ←	Total	91
4: 9.1 ←	9: 10.2x ↓		
5: 10.1 ↙	10: 8.9 ←		

11: 9.8 ←	16: 9.9 ↙	Serie	92
12: 9.9 ↙	17: 10.7x ↓		
13: 9.7 ↗	18: 9.8 ↙	Total	183
14: 9.4 →	19: 9.0 ↙		
15: 9.7 ↓	20: 10.5x ←		

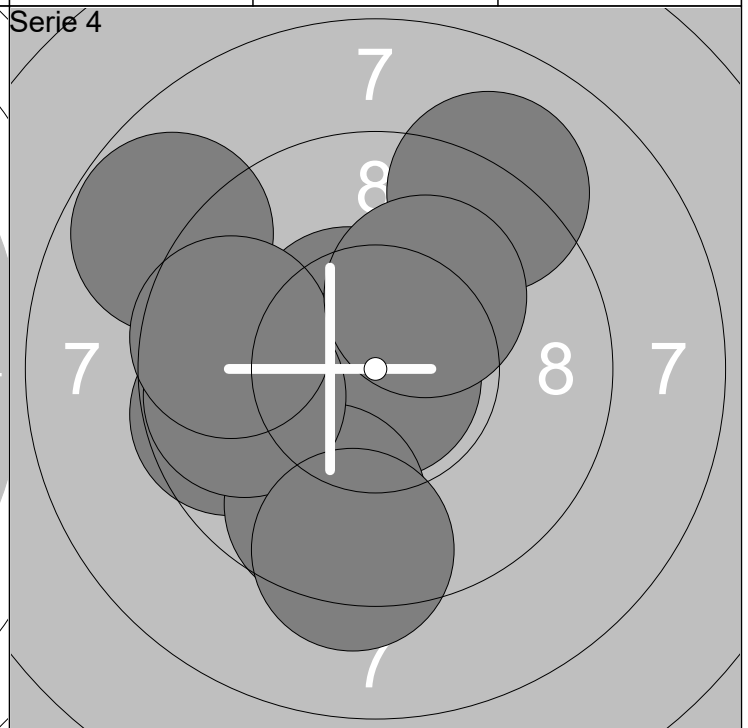
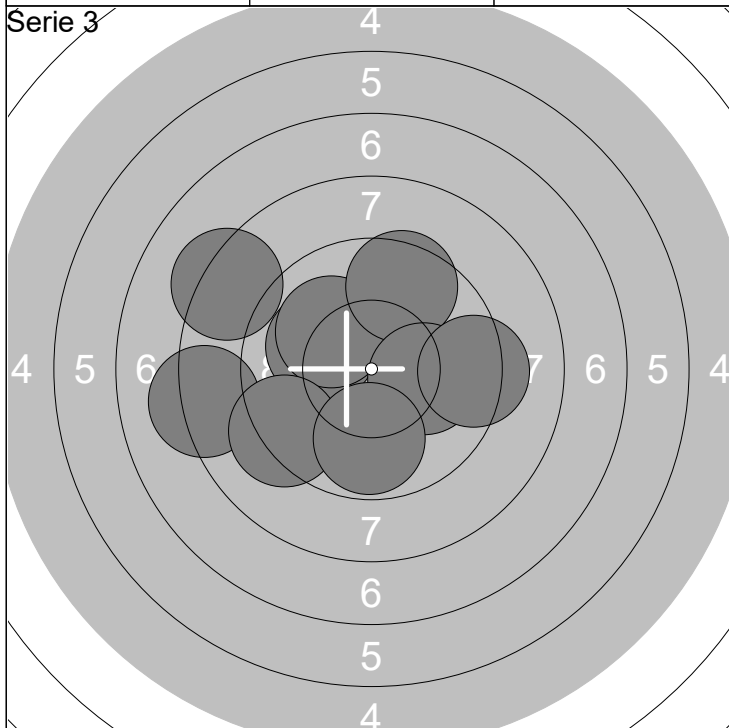

21: 10.1 ↙	26: 9.6 ↗	Serie	92
22: 10.1 ↗	27: 10.1 →		
23: 8.3 ↗	28: 9.3 →	Total	275
24: 10.1 →	29: 9.2 ↙		
25: 8.2 ←	30: 9.8 ↓		

31: 10.5x ↗	36: 9.7 ↓	Serie	92
32: 9.1 ↗	37: 9.8 ←		
33: 10.9x ↓	38: 9.6 ←	Total	367
34: 9.6 ←	39: 9.3 ↓		
35: 8.8 ↙	40: 10.2x ↗		

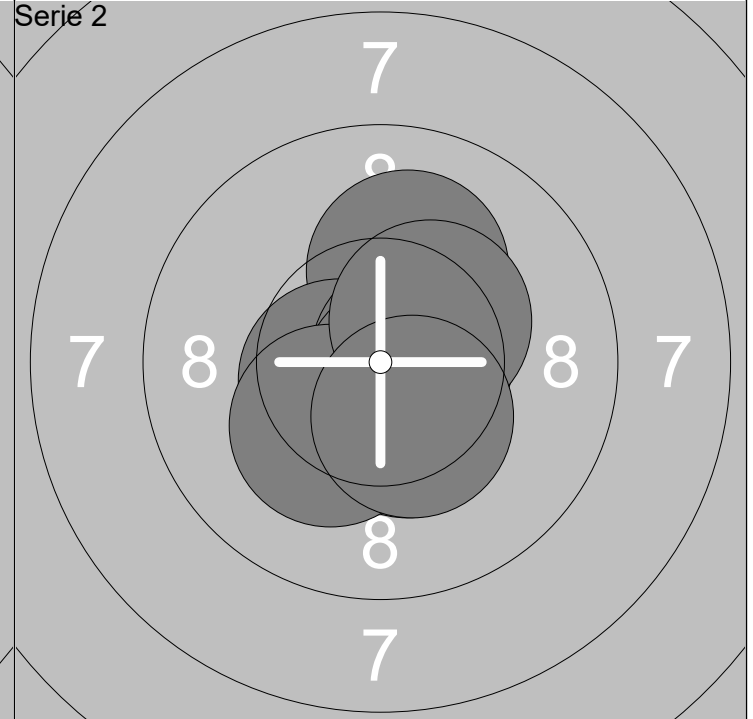
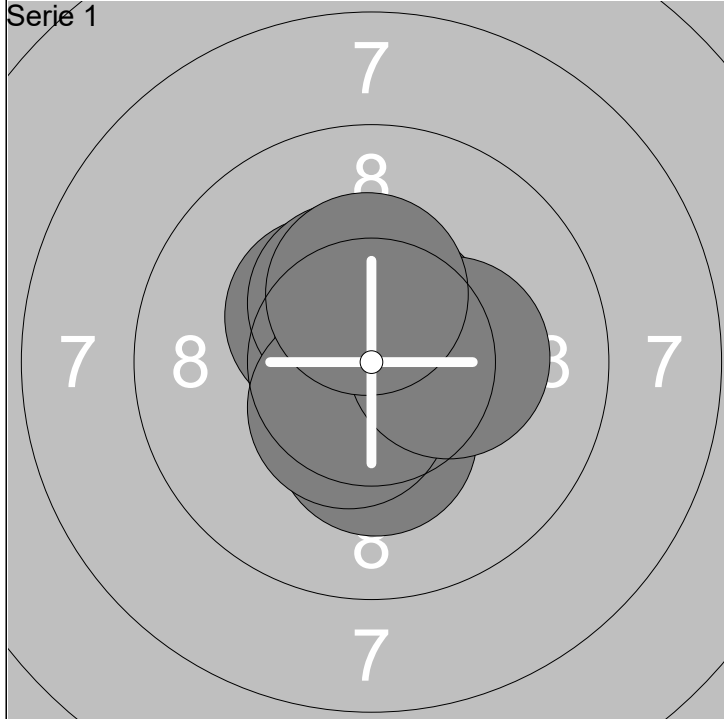

1: 10.4x ↖	6: 10.6x →	Serie	100
2: 10.4x ↗	7: 10.3x ↓		
3: 10.6x ↗	8: 10.5x ↓	Total	100
4: 10.5x ↓	9: 10.3x →		
5: 10.8x ↗	10: 10.4x ↗		

11: 10.7x ↓	16: 10.4x ↓	Serie	100
12: 10.1 ↗	17: 10.7x ↓		
13: 10.5x ↓	18: 10.2x ↓	Total	200
14: 10.6x ←	19: 10.4x ↗		
15: 10.7x →	20: 10.4x ↓		

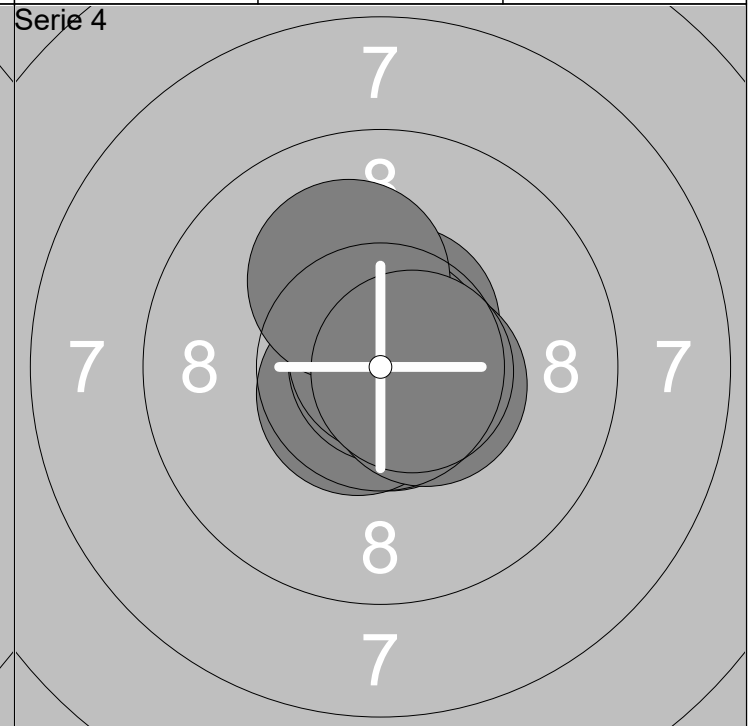
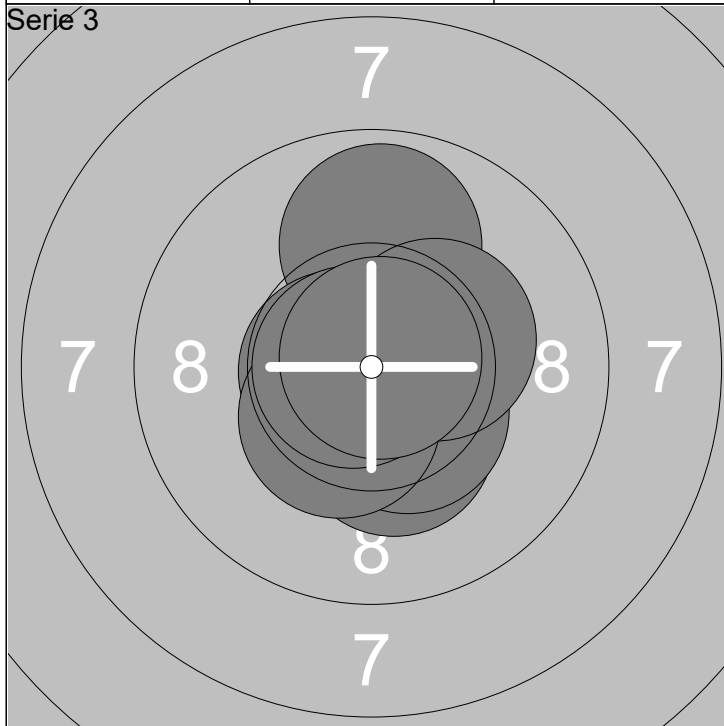

21: 10.6x ↓	26: 10.4x ↓	Serie	99
22: 10.3x ↓	27: 10.4x ↓		
23: 9.9 ↗	28: 10.3x →	Total	299
24: 10.5x ↓	29: 10.8x ←		
25: 10.7x ←	30: 10.8x ↗		

31: 10.9x →	36: 10.8x ↗	Serie	100
32: 10.6x ↗	37: 10.8x ↗		
33: 10.9x ↗	38: 10.1 ↗	Total	399
34: 10.7x ↓	39: 10.5x →		
35: 10.6x ↘	40: 10.7x →		

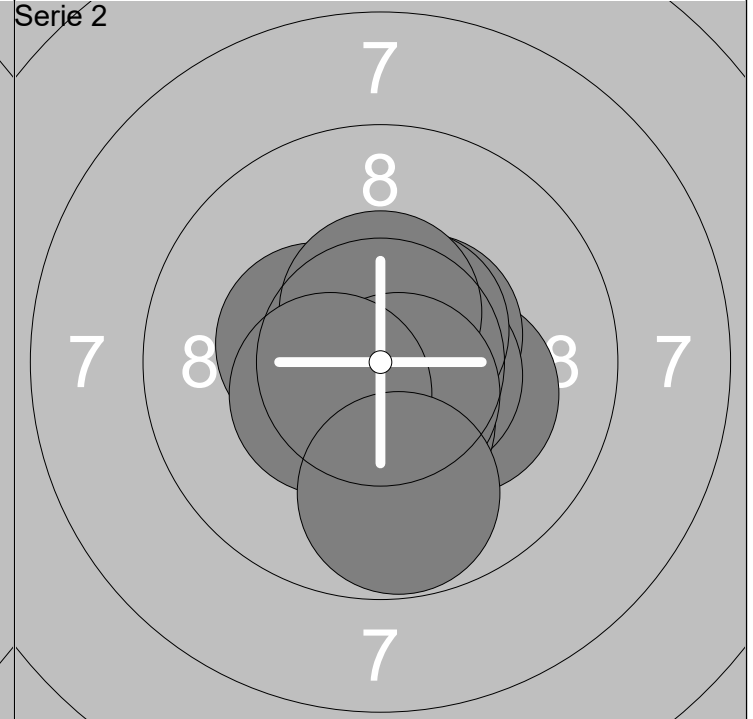
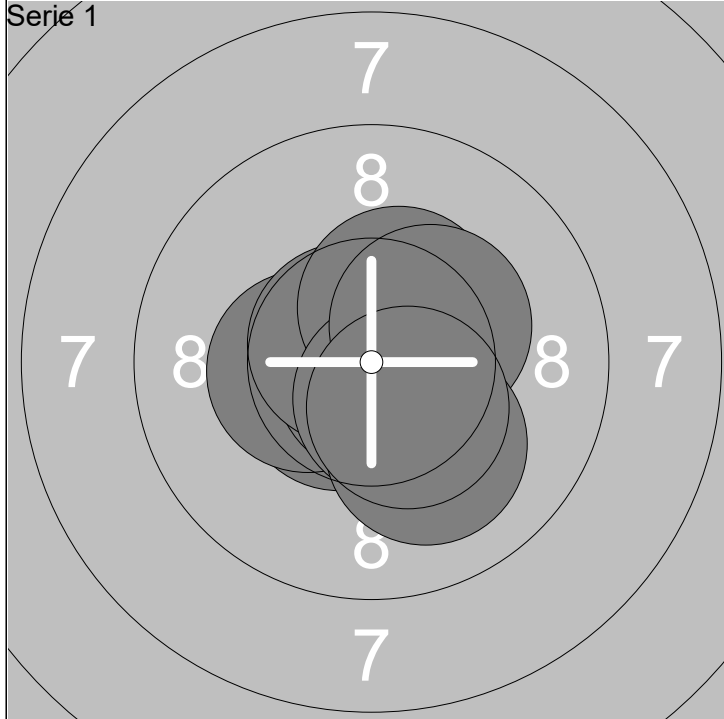

1: 10.6x ↙	6: 10.4x ↗	Serie 100
2: 10.4x ←	7: 10.6x ↓	
3: 10.8x ↓	8: 10.4x ↗	Total 100
4: 10.8x ↗	9: 10.1 ↓	
5: 10.7x ↖	10: 10.4x ↓	

11: 10.2x →	16: 10.6x ↗	Serie 99
12: 10.5x ↗	17: 10.5x ↑	
13: 10.6x →	18: 10.6x ↓	Total 199
14: 10.4x ↓	19: 10.4x ↙	
15: 10.4x ↖	20: 9.8 ↓	

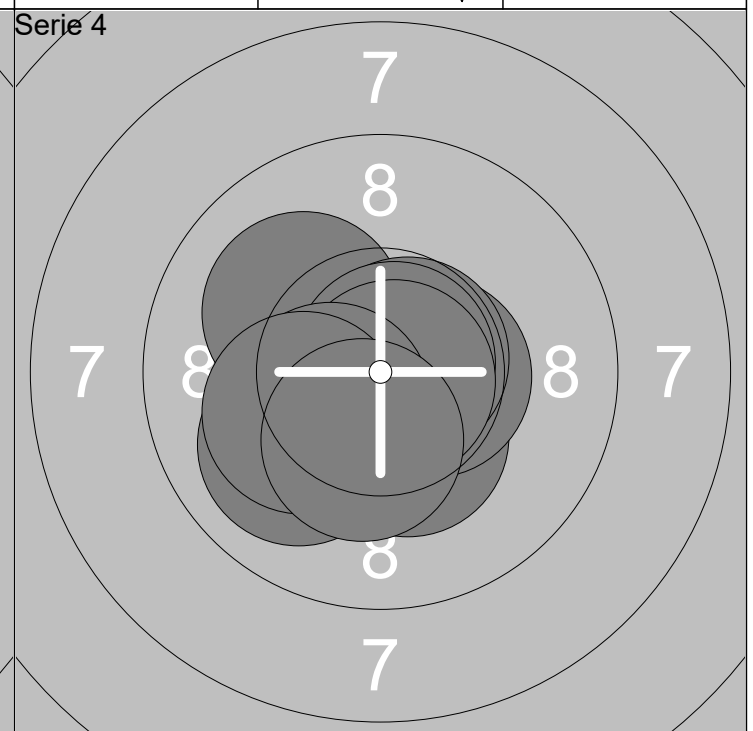
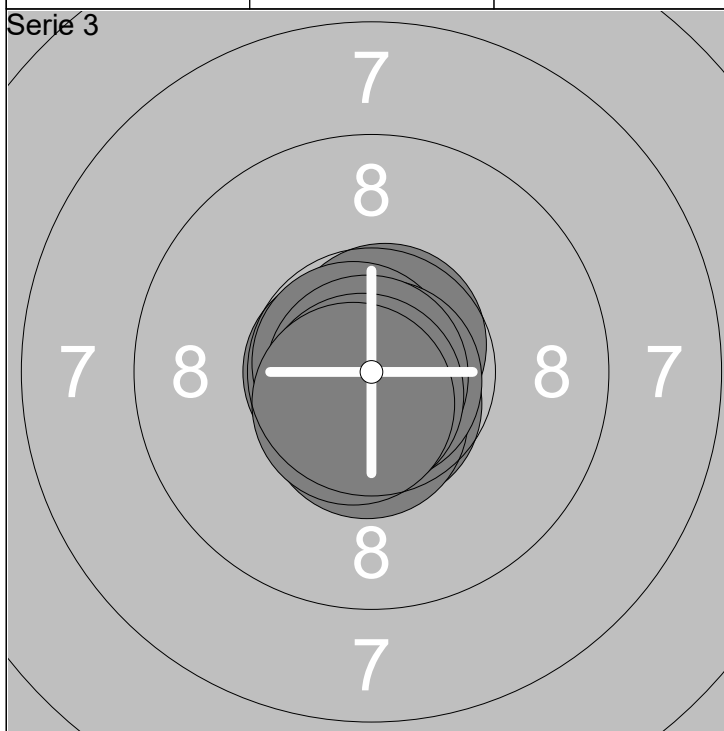

21: 10.9x ↖	26: 10.8x ↖	Serie 100
22: 10.7x ←	27: 10.8x ↓	
23: 10.7x ↗	28: 10.9x ↙	Total 299
24: 10.7x ↓	29: 10.7x ↓	
25: 10.5x ↓	30: 10.6x ↓	

31: 10.3x ↓	36: 10.0 ↙	Serie 100
32: 10.1 ↖	37: 10.8x ↘	
33: 10.5x →	38: 10.4x ↙	Total 399
34: 10.7x ↗	39: 10.2x ↙	
35: 10.8x ↗	40: 10.3x ↓	

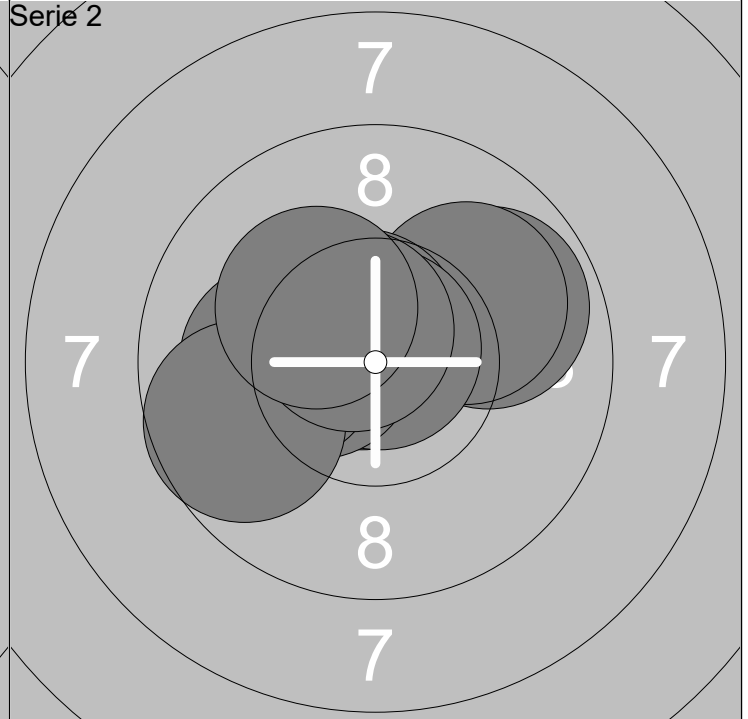
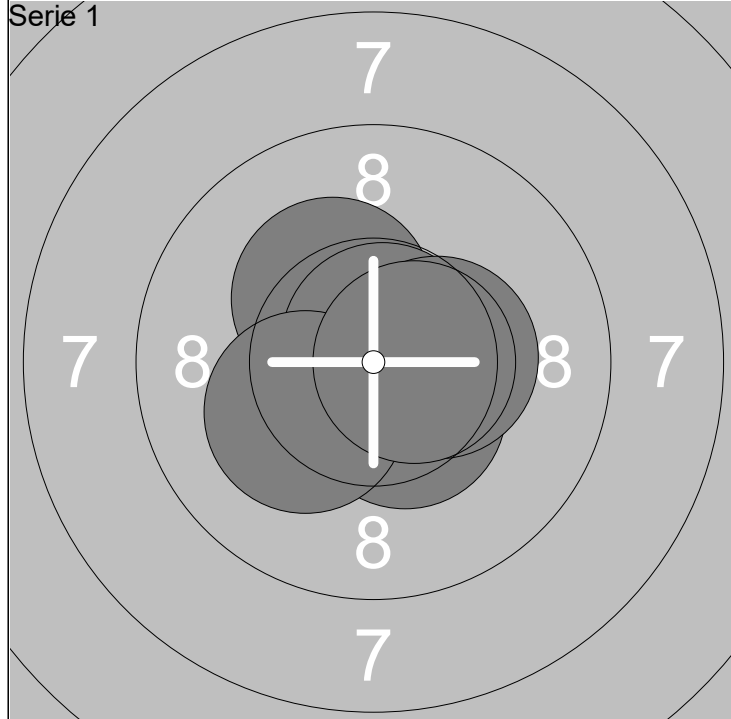

1: 10.7x ↙	6: 10.8x ↗	Serie	100
2: 10.8x →	7: 10.5x ↘		
3: 10.9x ↗	8: 10.2x ↙	Total	100
4: 10.3x ↗	9: 10.4x →		
5: 10.8x →	10: 10.6x →		

11: 9.9 ↗	16: 10.4x ←	Serie	98
12: 10.0 ↗	17: 10.1 ←		
13: 10.6x ↗	18: 9.7 ←	Total	198
14: 10.8x ↙	19: 10.6x ↗		
15: 10.8x ↗	20: 10.3x ↙		

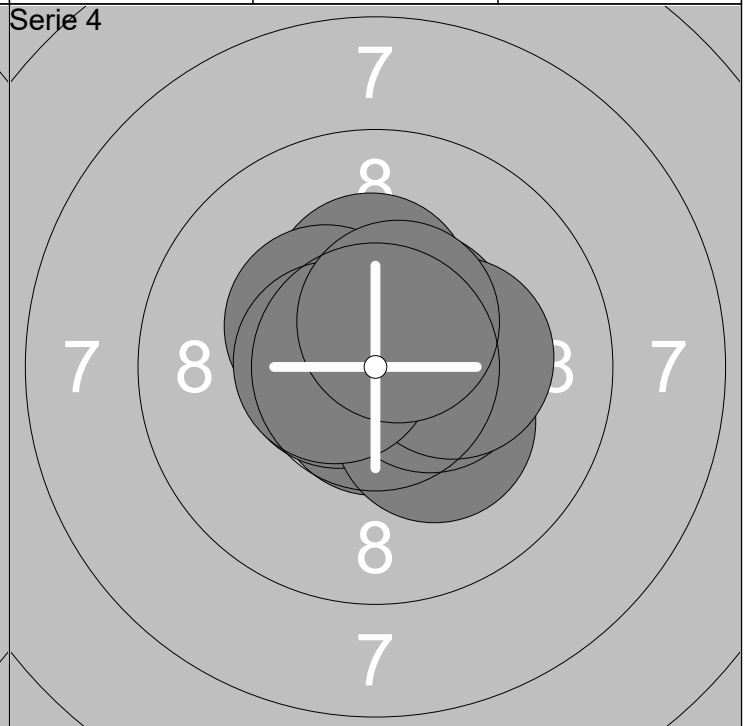
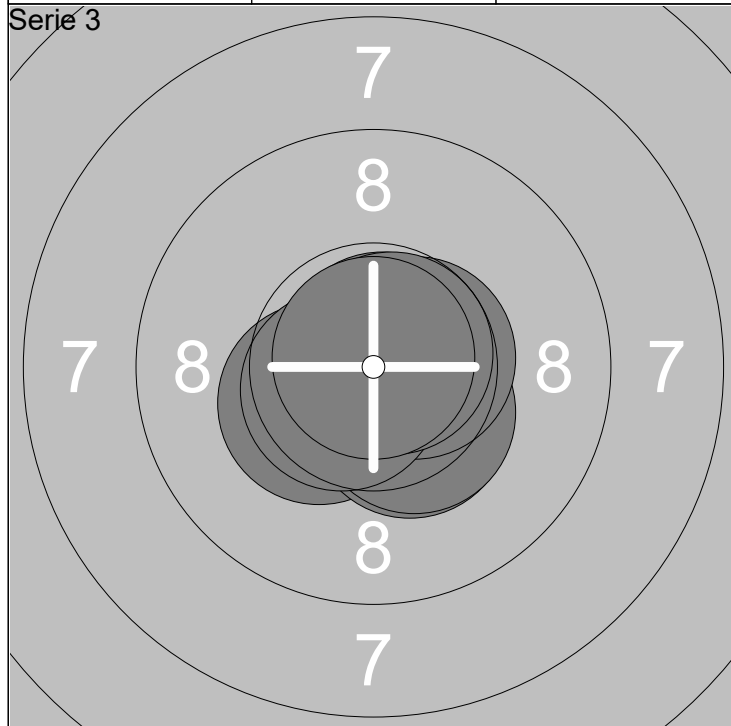

21: 10.6x ↙	26: 10.4x ↘	Serie	100
22: 10.8x ↗	27: 10.6x →		
23: 10.8x ↘	28: 10.6x ↙	Total	298
24: 10.4x ↙	29: 10.7x ↗		
25: 10.4x ↘	30: 10.9x ↗		

31: 10.7x ↓	36: 10.3x ↗	Serie	100
32: 10.5x ↗	37: 10.4x ↙		
33: 10.6x ←	38: 10.3x →	Total	398
34: 10.3x ↘	39: 10.6x ←		
35: 10.5x →	40: 10.5x ↗		

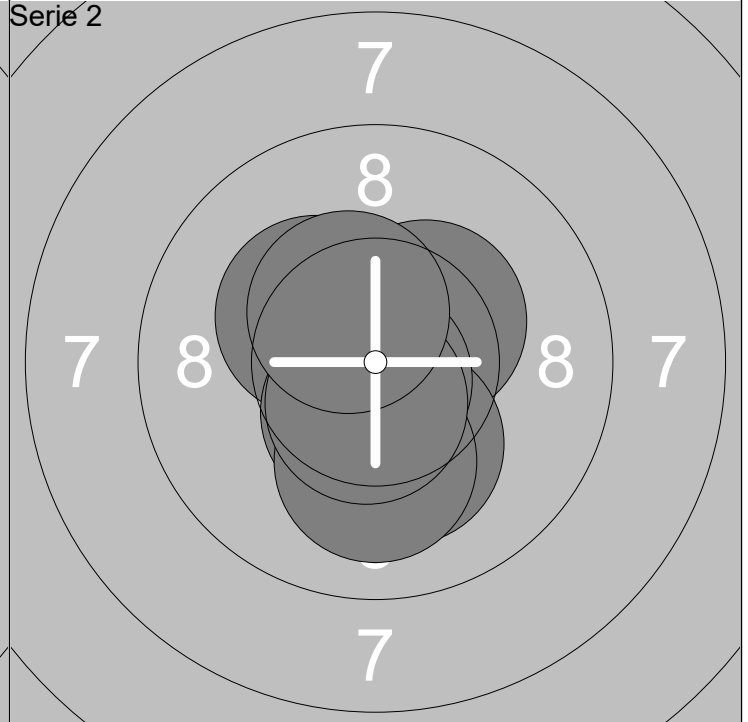
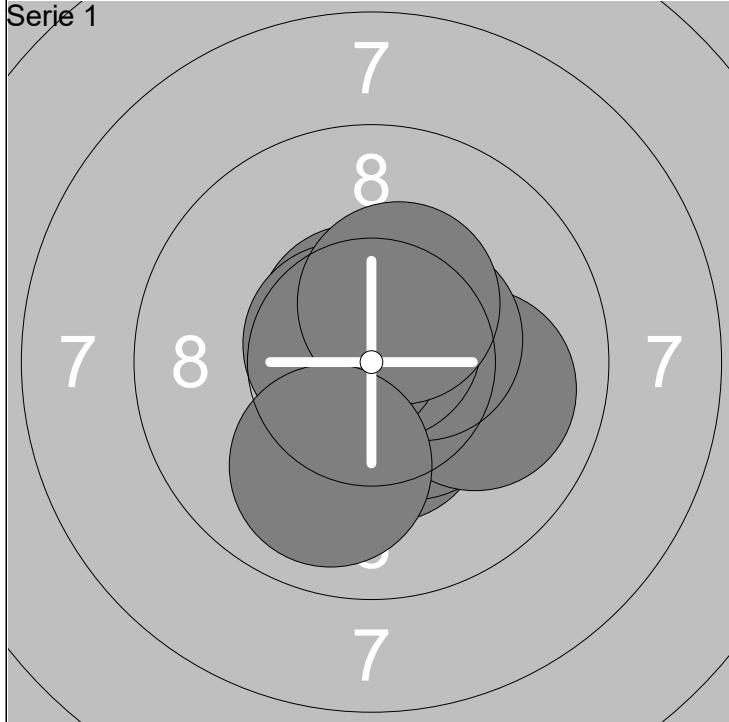

1: 10.4x ↓	6: 10.7x ↗	Serie	100
2: 10.5x ↓	7: 10.6x ↗		
3: 10.0 →	8: 10.7x ↖	Total	100
4: 10.8x ↖	9: 10.4x ↗		
5: 10.5x ↗	10: 10.0 ↓		

11: 10.7x ↖	16: 10.5x ↓	Serie	100
12: 10.8x ←	17: 10.8x ↓		
13: 10.3x ↖	18: 10.1 ↓	Total	200
14: 10.4x ↗	19: 10.6x ↓		
15: 10.2x ↓	20: 10.4x ↖		

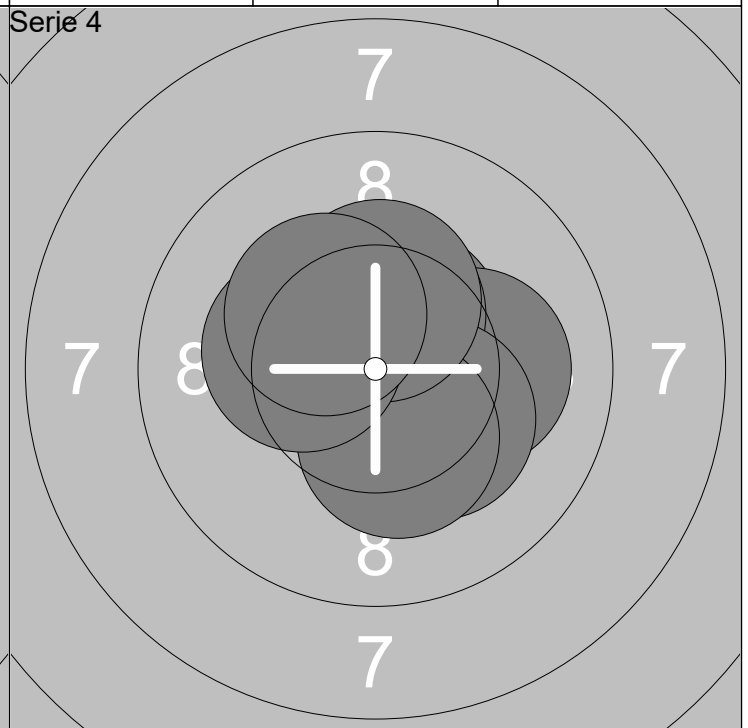
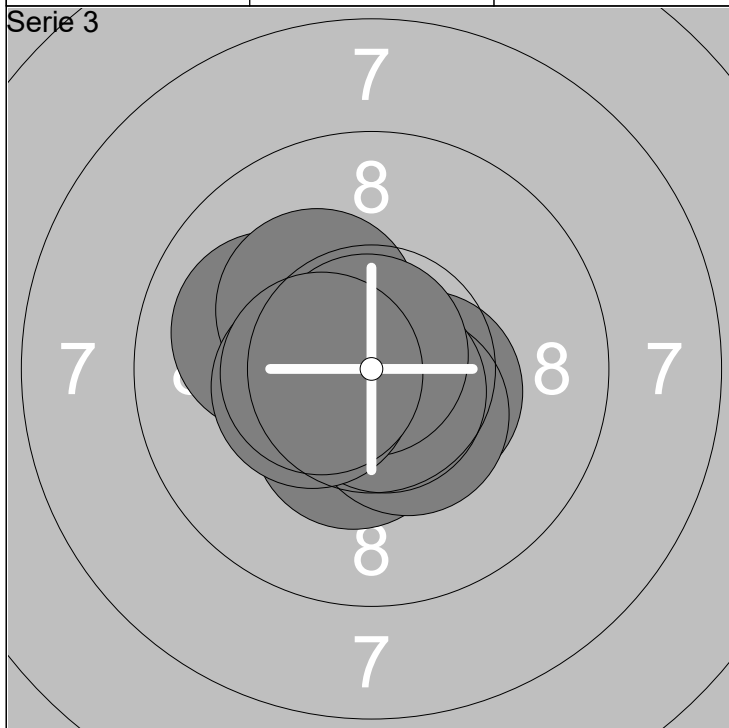

21: 10.4x →	26: 10.4x ↓	Serie	100
22: 10.0 ↖	27: 10.7x ↓		
23: 10.4x ↓	28: 10.8x ↗	Total	300
24: 10.7x ↗	29: 10.4x ←		
25: 10.2x ↗	30: 10.5x ←		

31: 10.4x ↓	36: 10.3x ↓	Serie	100
32: 10.5x ↗	37: 10.3x ↓		
33: 10.9x ↗	38: 10.3x ↑	Total	400
34: 10.1 →	39: 10.3x ←		
35: 10.5x ↑	40: 10.3x ↖		

Skjutlag
4

Tavla
2

Rasmus Johansson

Rottne Industri Cup 2018

Eringsboda/Backaryd

Mini

27.10.2018

Rottne Industri Cup 2018

Söraby SKF

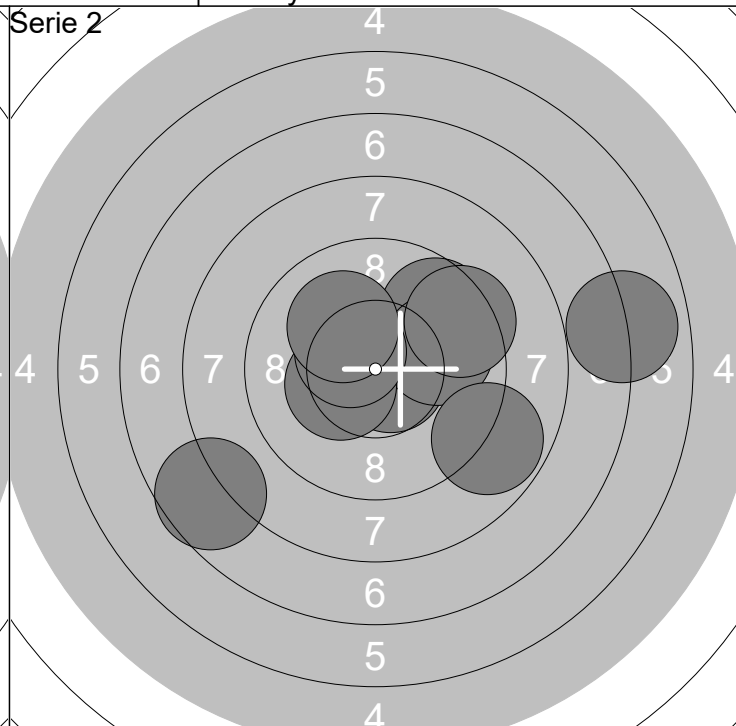
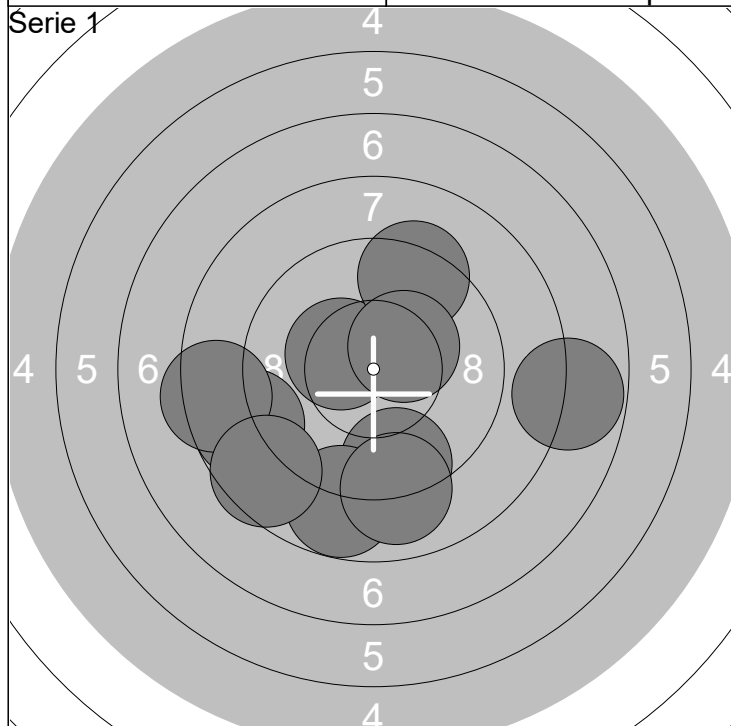

1: 8.8	←	6: 9.3	↗
2: 8.4	←	7: 9.0	↓
3: 10.4x	↖	8: 10.4x	↗
4: 9.4	↓	9: 7.8	→
5: 8.8	↓	10: 8.6	↙

Serie	86
Total	86

11: 10.7x	↘	16: 7.6	↙
12: 9.6	↗	17: 10.3x	↖
13: 6.9	→	18: 10.5x	↖
14: 9.9	→	19: 10.1	↗
15: 9.4	↗	20: 8.8	↘

Serie	88
Total	174

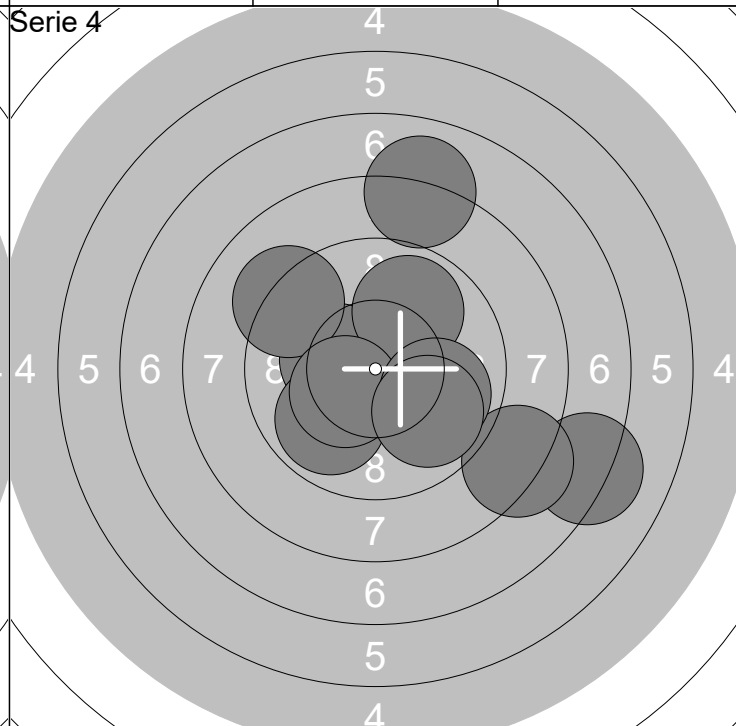
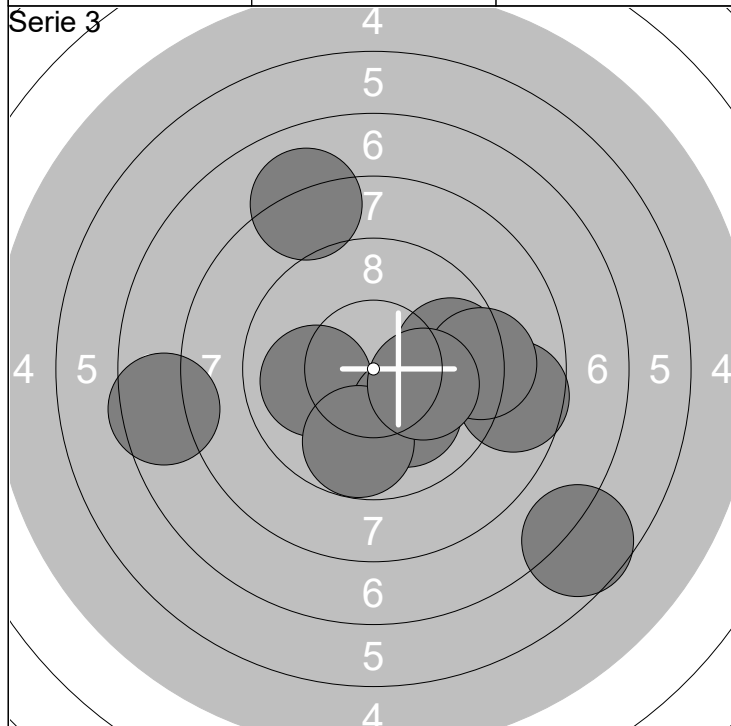

21: 10.0	←	26: 8.1	↗
22: 10.1	↘	27: 8.7	→
23: 9.7	→	28: 9.2	→
24: 7.5	←	29: 6.6	↘
25: 9.8	↓	30: 10.1	↘

Serie	86
Total	260

31: 7.2	→	36: 8.0	↗
32: 10.3x	↖	37: 10.3x	↖
33: 9.9	↗	38: 8.2	↘
34: 9.2	↖	39: 9.9	↘
35: 9.9	↙	40: 9.9	↘

Serie	88
Total	348

Rottne Industri Cup 2018

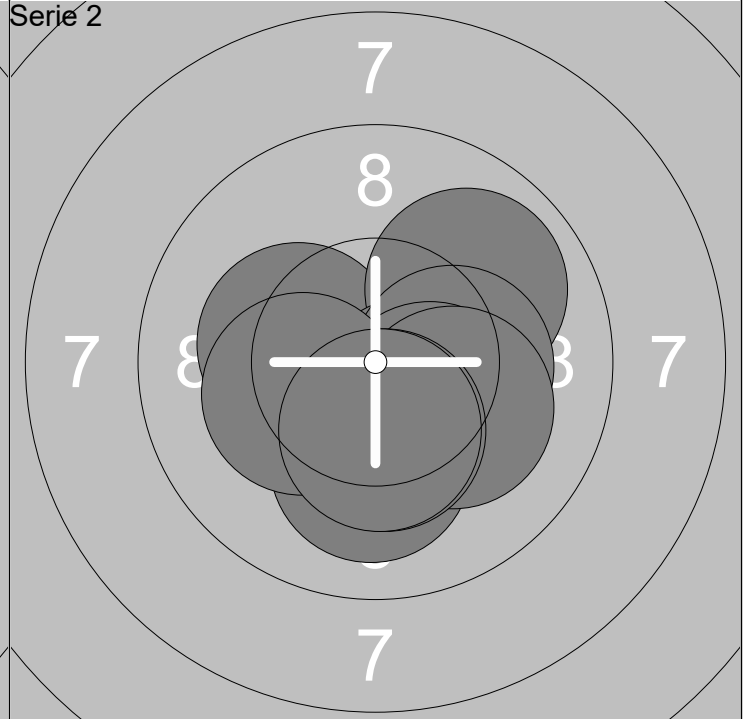
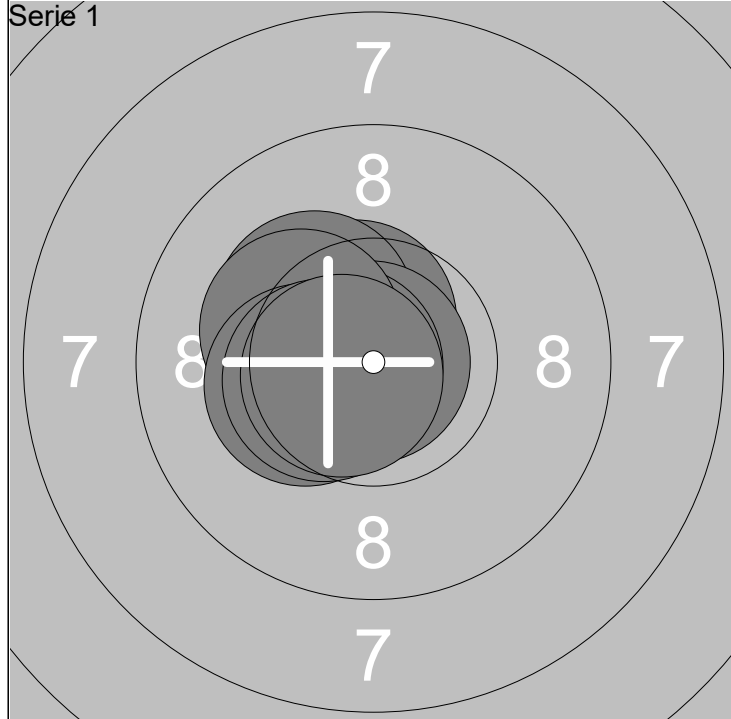

1: 10.5x ↗	6: 10.7x ←	Serie	100
2: 10.3x ↗	7: 10.3x ↖		
3: 10.4x ←	8: 10.3x ←	Total	100
4: 10.4x ←	9: 10.5x ←		
5: 10.9x ←	10: 10.6x ←		

11: 10.3x ←	16: 10.0 ↓	Serie	99
12: 9.9 ↗	17: 10.1 ↘		
13: 10.5x ↘	18: 10.2x ←	Total	199
14: 10.3x →	19: 10.4x ↓		
15: 10.4x ↘	20: 10.3x ↓		

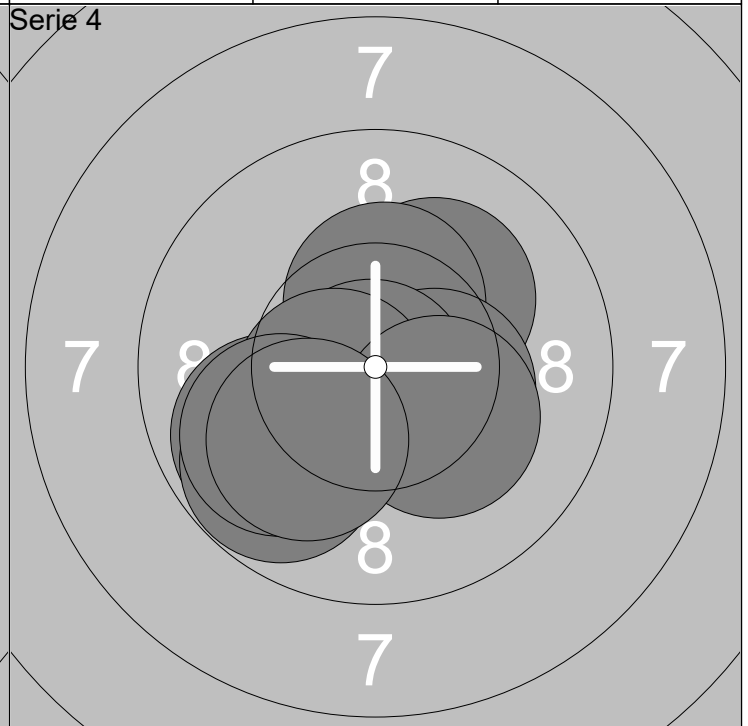
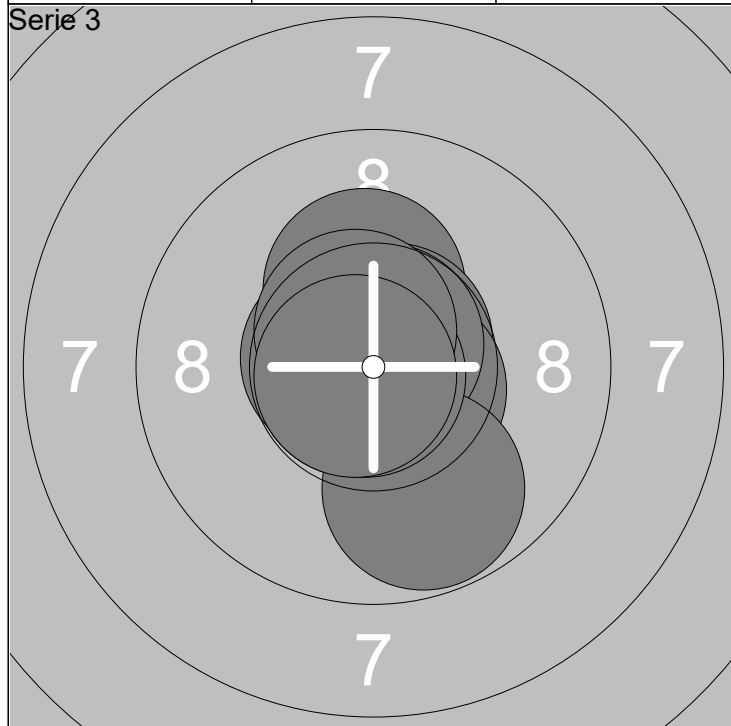

21: 10.8x ←	26: 10.7x ↗	Serie	99
22: 10.7x ←	27: 9.8 ↓		
23: 10.3x ↑	28: 10.8x ↘	Total	298
24: 10.7x ↗	29: 10.6x ↗		
25: 10.6x ↘	30: 10.8x ←		

31: 10.2x ↗	36: 10.5x ←	Serie	97
32: 9.8 ←	37: 9.8 ↘		
33: 10.4x ↑	38: 9.9 ↘	Total	395
34: 10.4x →	39: 10.2x ↘		
35: 10.8x ↓	40: 10.1 ↘		

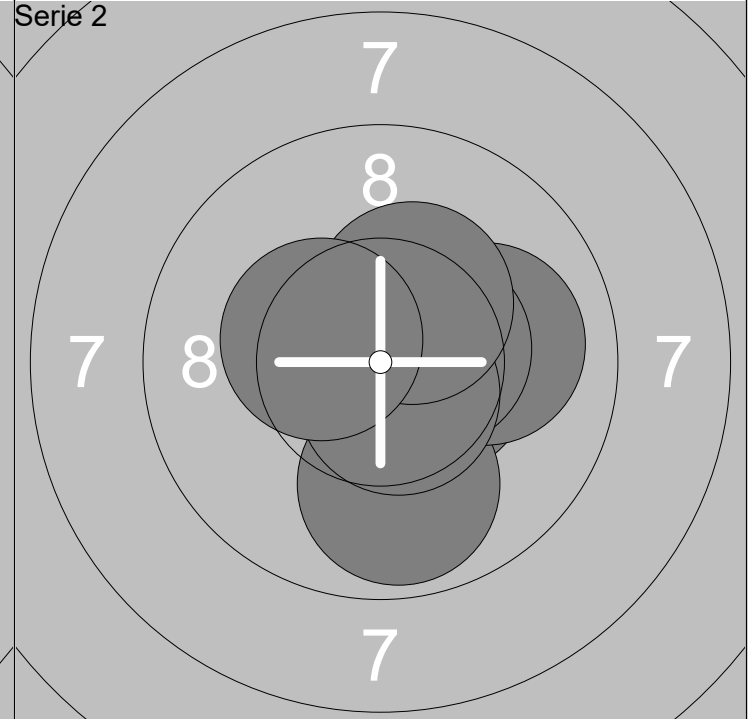
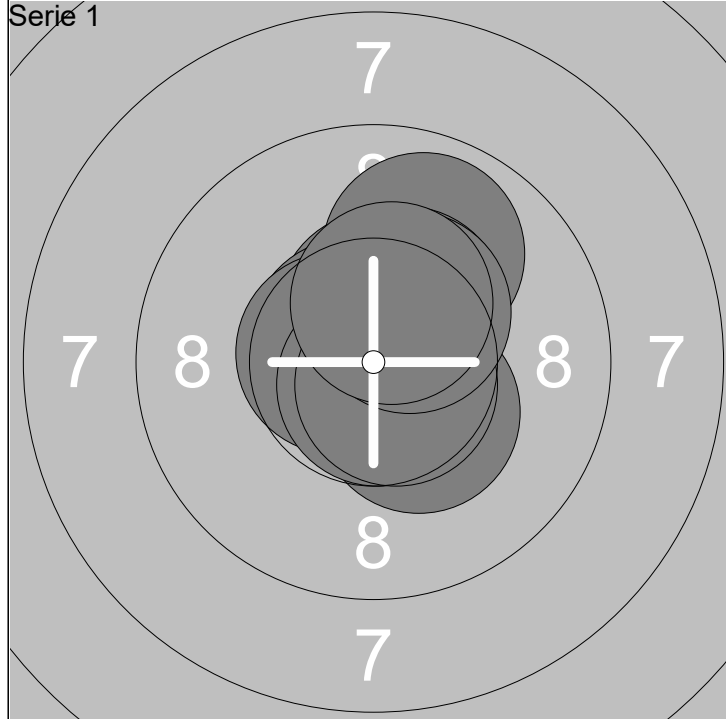

1: 10.5x ↑	6: 10.8x ↓	Serie	99
2: 10.7x ↗	7: 10.7x ↘		
3: 10.6x ←	8: 10.4x ↗	Total	99
4: 10.4x ↘	9: 10.4x ↗		
5: 9.9 ↑	10: 10.4x ↑		

11: 10.5x →	16: 10.7x ↑	Serie	99
12: 10.8x ↗	17: 10.5x →		
13: 9.9 ↓	18: 10.6x ↘	Total	198
14: 10.8x →	19: 10.4x ↗		
15: 10.0 →	20: 10.4x ←		

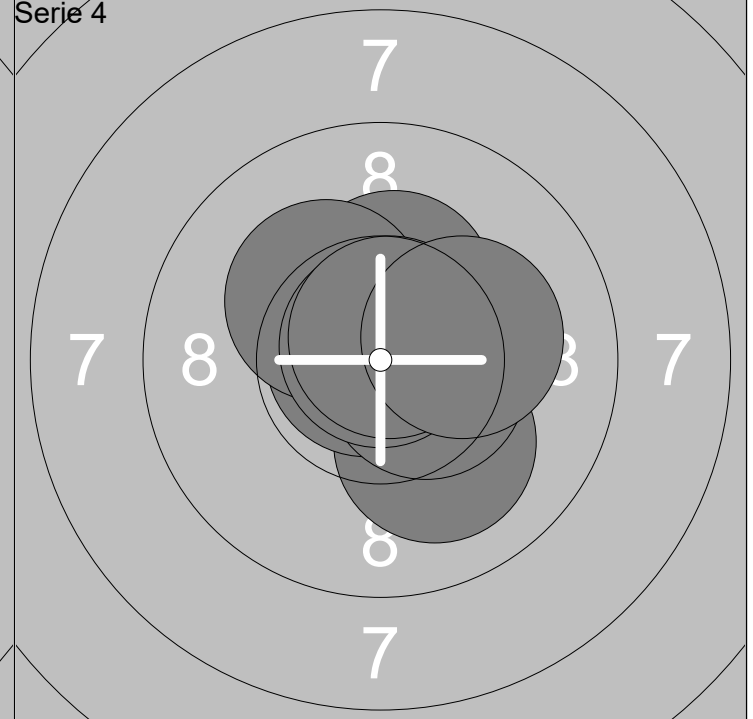
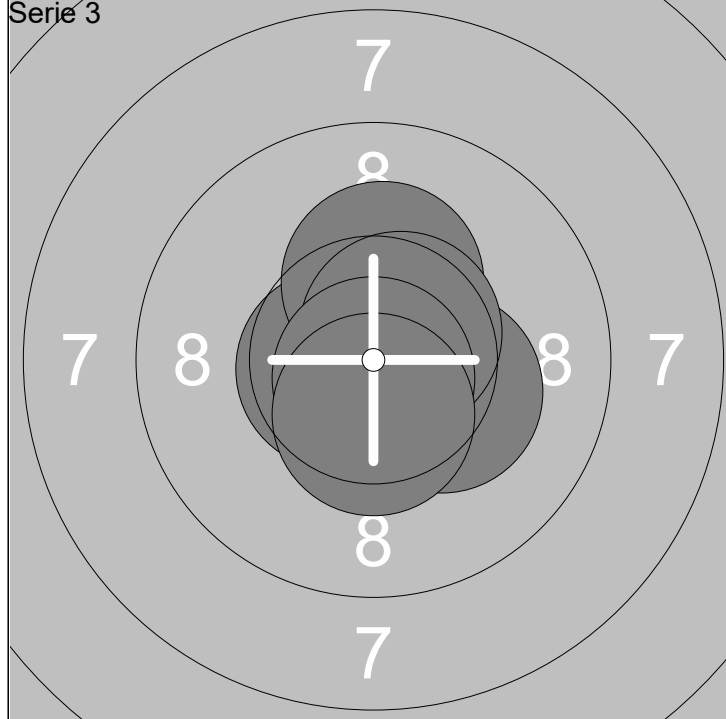

21: 10.6x ↗	26: 10.6x ←	Serie	100
22: 10.8x ↗	27: 10.3x ↑		
23: 10.3x →	28: 10.6x ↗	Total	298
24: 10.7x ↗	29: 10.8x ↓		
25: 10.7x ↗	30: 10.5x ↓		

31: 10.6x ↗	36: 10.5x →	Serie	100
32: 10.9x ↗	37: 10.3x ↗		
33: 10.4x ↑	38: 10.8x ↑	Total	398
34: 10.1 ↓	39: 10.7x ↗		
35: 10.8x ←	40: 10.2x →		

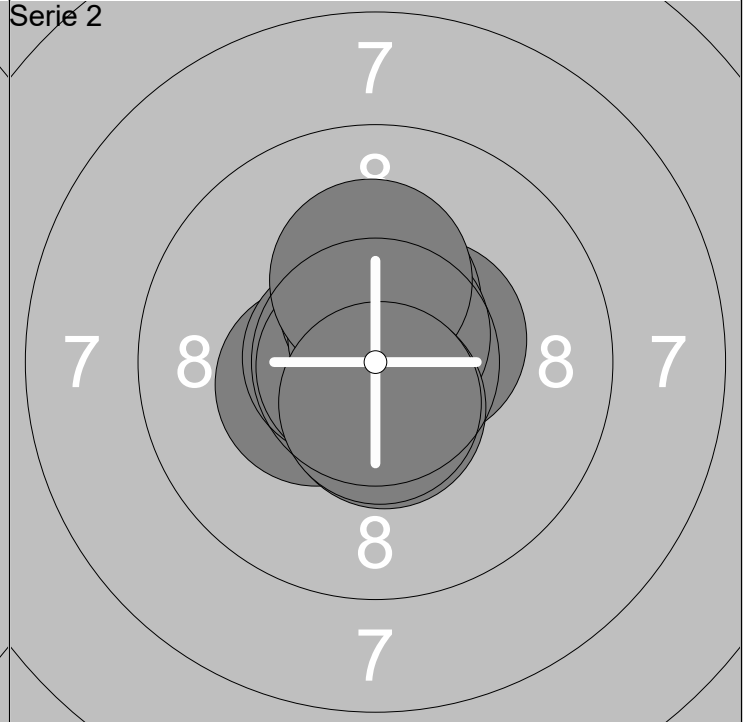
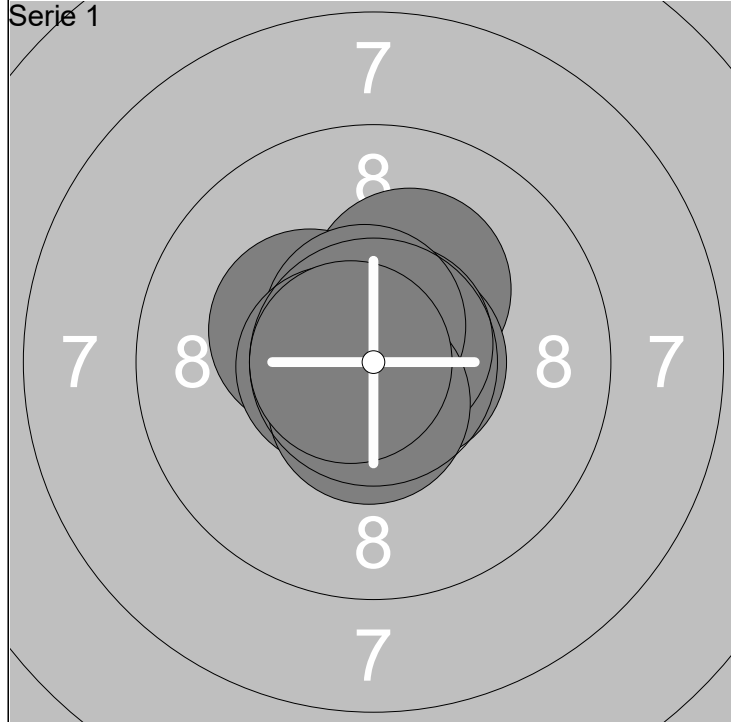

1: 10.2x ↗	6: 10.6x ↗	Serie	100
2: 10.7x →	7: 10.7x ←		
3: 10.8x ↘	8: 10.6x ←	Total	100
4: 10.3x ↖	9: 10.6x ↓		
5: 10.7x ↗	10: 10.7x ←		

11: 10.4x ←	16: 10.4x ↗	Serie	100
12: 10.7x ←	17: 10.7x ↗		
13: 10.9x ↗	18: 10.2x ↗	Total	200
14: 10.8x ←	19: 10.5x ↓		
15: 10.5x ↗	20: 10.6x ↓		

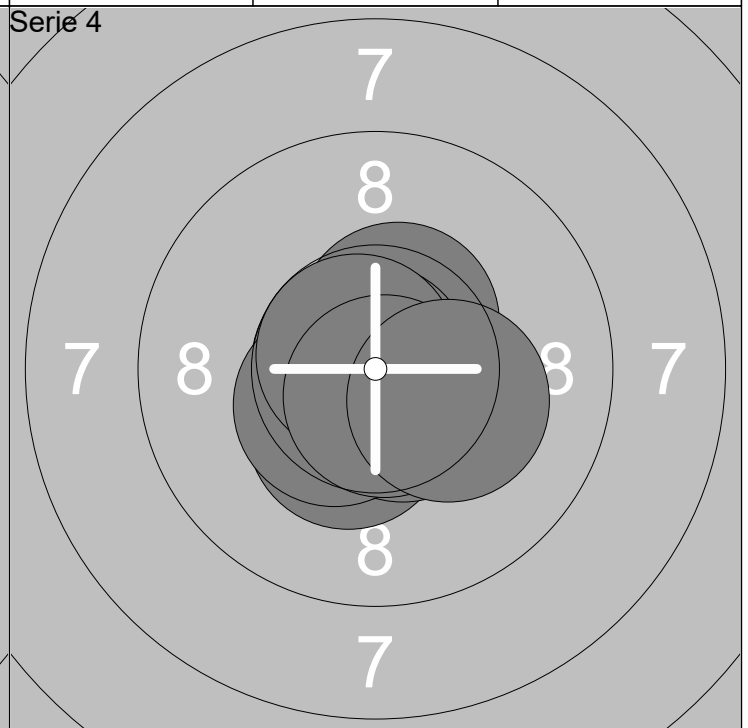
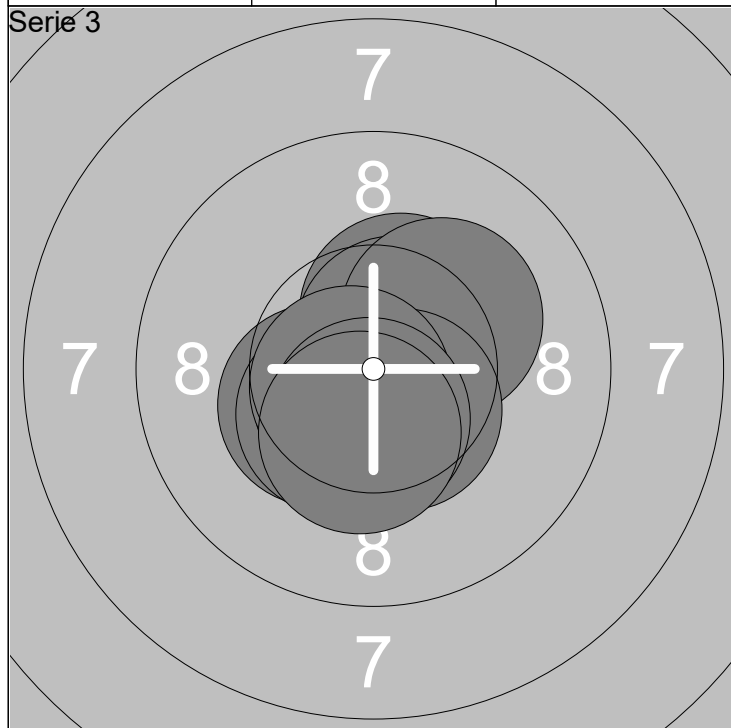

21: 10.4x ↗	26: 10.6x ↘	Serie	100
22: 10.6x ↗	27: 10.5x ↘		
23: 10.2x ↗	28: 10.7x ↖	Total	300
24: 10.4x ↖	29: 10.5x ↓		
25: 10.4x ↘	30: 10.4x ↓		

31: 10.4x ↘	36: 10.6x ↘	Serie	100
32: 10.5x ↗	37: 10.5x ↖		
33: 10.9x ↖	38: 10.7x ↖	Total	400
34: 10.6x ↘	39: 10.7x ↓		
35: 10.8x ←	40: 10.2x ↗		

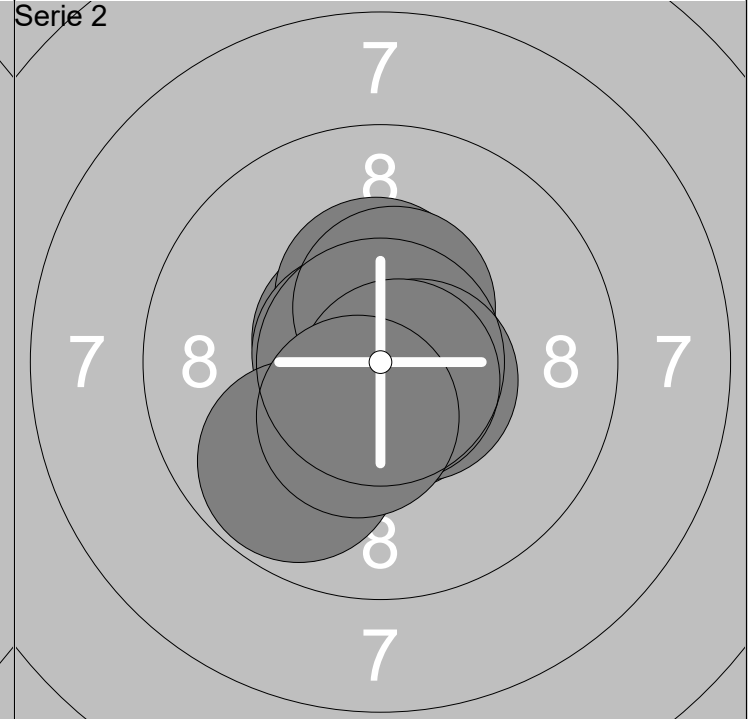
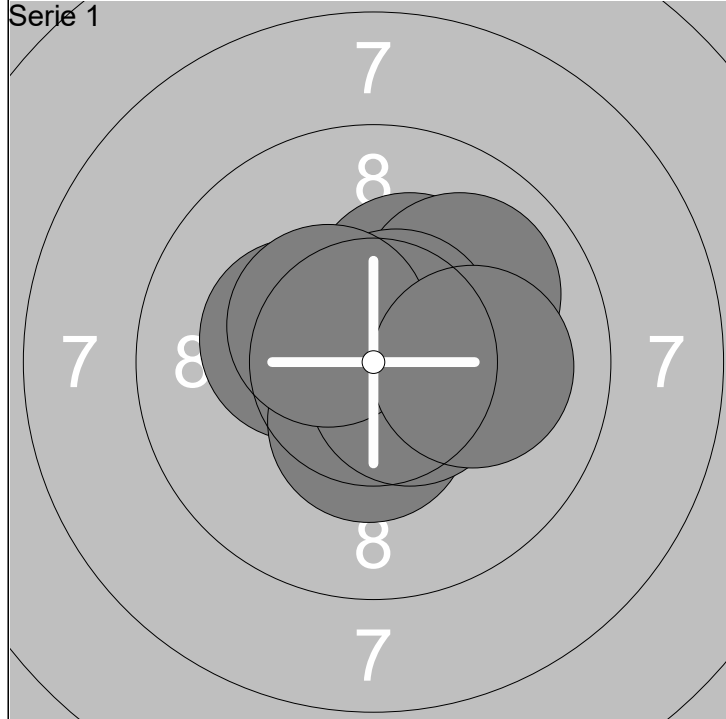

1: 10.7x ↗	6: 10.0 ↗	Serie 100
2: 10.3x ←	7: 10.6x ↗	
3: 10.2x ↗	8: 10.6x ↘	Total 100
4: 10.4x ↓	9: 10.4x ↗	
5: 10.8x ↑	10: 10.1 →	

11: 10.6x ↗	16: 10.7x ↓	Serie 99
12: 10.9x ←	17: 10.6x →	
13: 10.4x ↑	18: 9.8 ↓	Total 199
14: 10.7x ←	19: 10.7x ↘	
15: 10.4x ↑	20: 10.4x ↓	

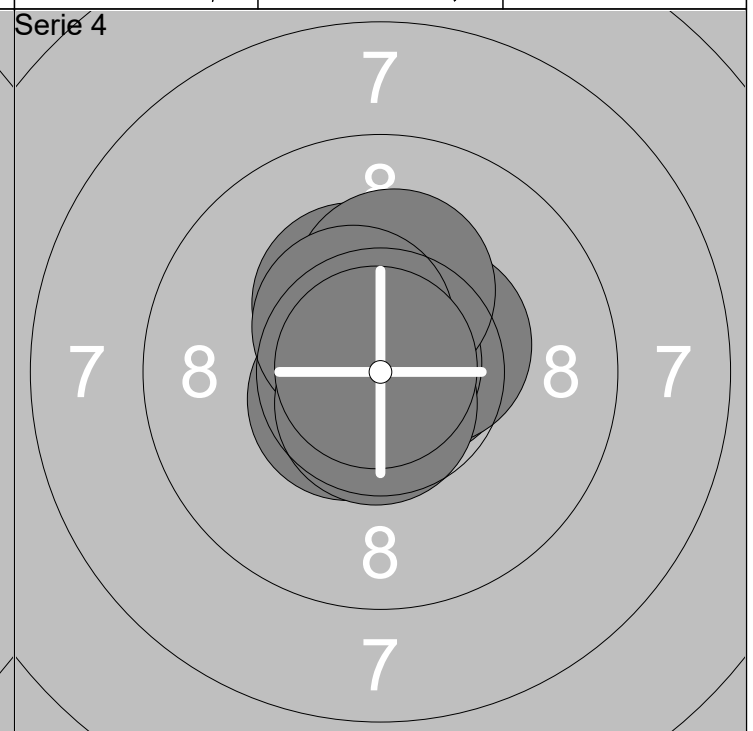
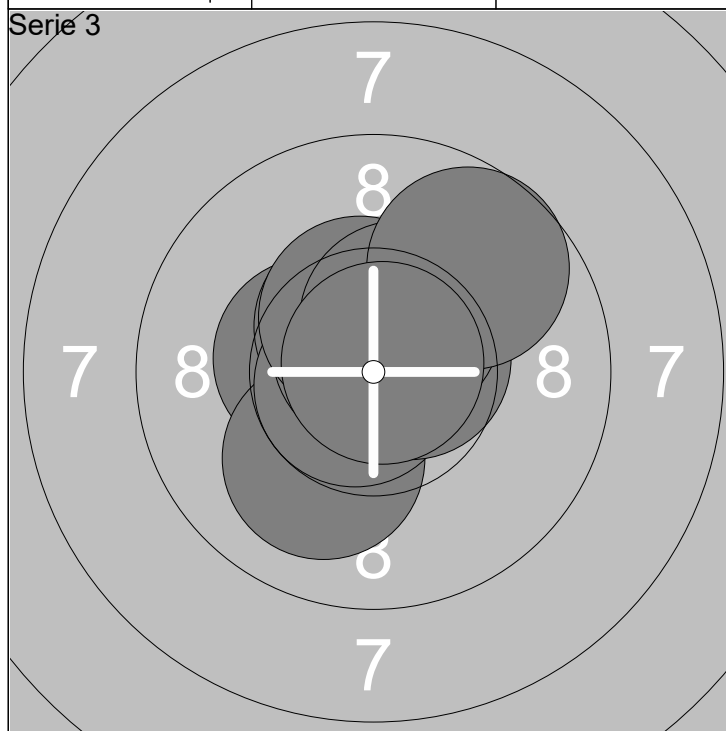

21: 10.4x ←	26: 10.7x ↑	Serie 99
22: 10.5x ↗	27: 10.5x ↑	
23: 10.1 ↓	28: 10.5x ↗	Total 298
24: 10.8x ←	29: 9.7 ↗	
25: 10.6x →	30: 10.8x ↗	

31: 10.7x ←	36: 10.6x ←	Serie 100
32: 10.7x →	37: 10.2x ↑	
33: 10.4x →	38: 10.5x ↗	Total 398
34: 10.9x ↑	39: 10.7x ↓	
35: 10.3x ↗	40: 10.9x ↗	

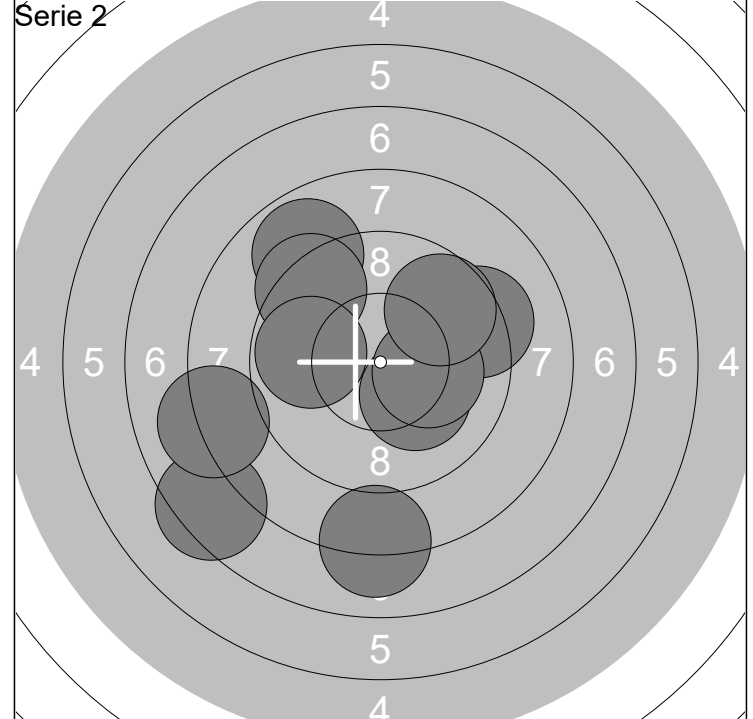
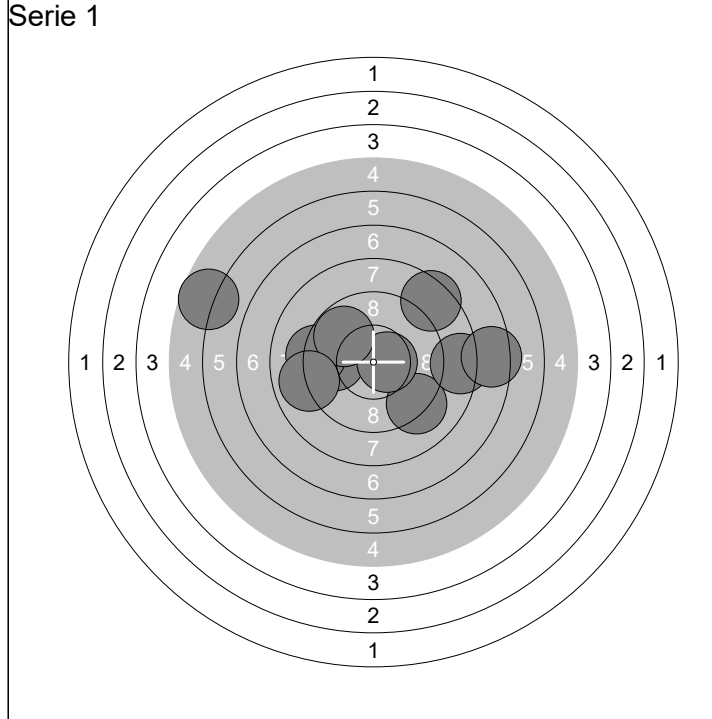

1: 5.7 ↖	6: 10.6x →		Serie	82	11: 10.2x ↘	16: 9.3 →		Serie	87
2: 9.1 ↘	7: 8.4 →				12: 8.9 ↗	17: 10.2x →			
3: 8.4 ↗	8: 7.4 →		Total	82	13: 9.3 ↗	18: 9.8 ←		Total	169
4: 9.8 ←	9: 9.8 ↗				14: 7.4 ↖	19: 9.7 ↗			
5: 9.2 ←	10: 8.9 ←				15: 8.1 ↓	20: 8.1 ←			

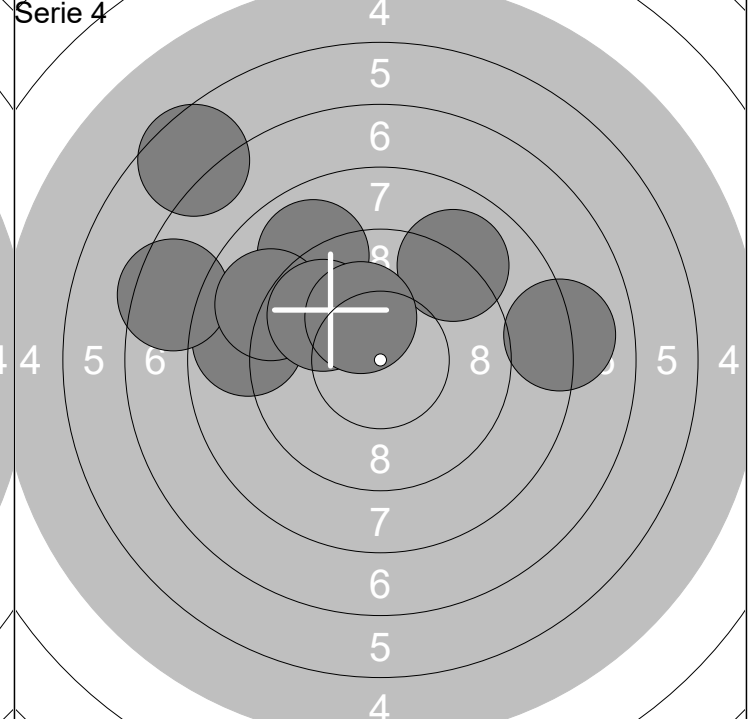
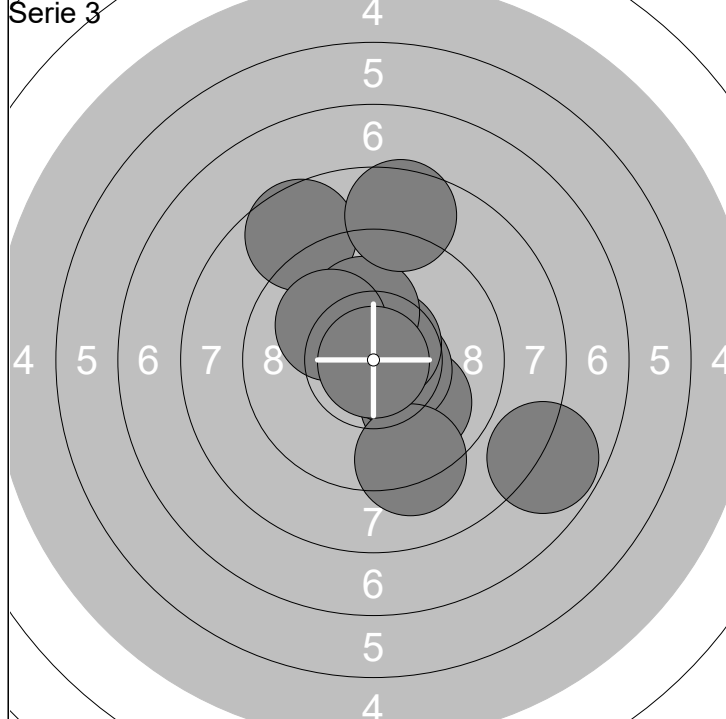

21: 8.6 ↗	26: 7.8 ↘		Serie	92	31: 8.8 ←	36: 7.5 ←		Serie	83
22: 10.0 ↘	27: 9.2 ↓				32: 9.8 ↗	37: 8.0 →			
23: 10.6x →	28: 10.1 ↗		Total	261	33: 8.9 ↗	38: 9.0 ←		Total	344
24: 10.6x ↗	29: 10.9x ↓				34: 6.6 ↗	39: 9.8 ↗			
25: 10.2x ↑	30: 8.6 ↑				35: 9.0 ↗	40: 10.2x ↗			

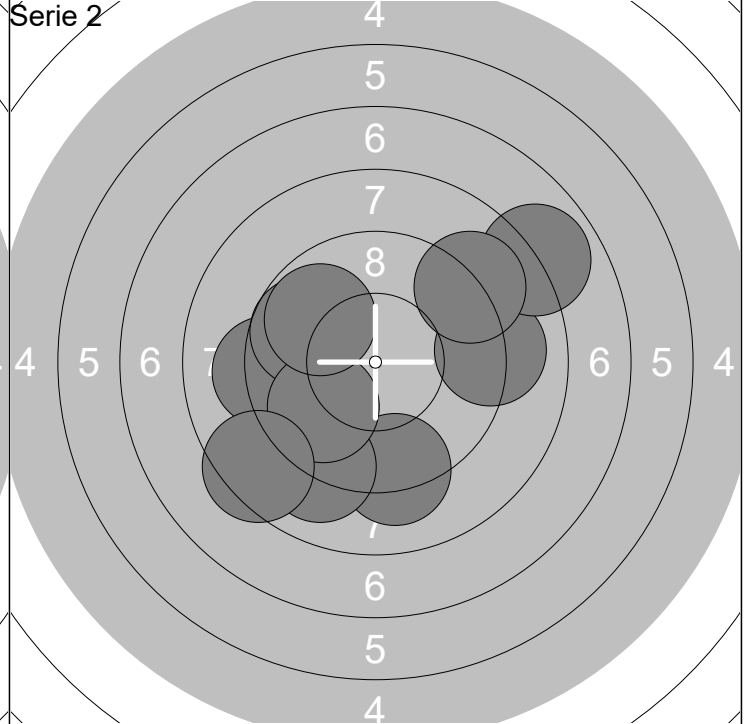
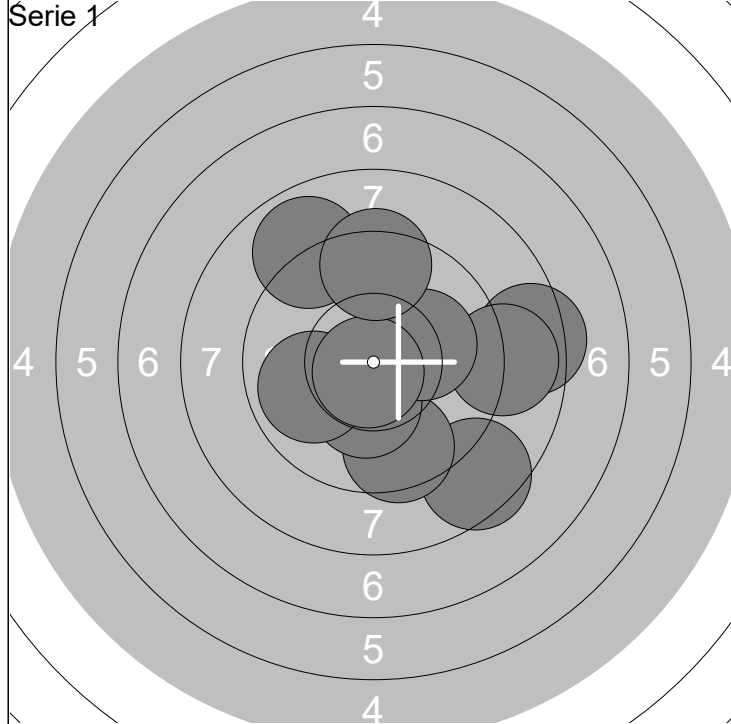

1: 8.4 →	6: 10.1 →		Serie	89	11: 9.2 ←	16: 9.2 ↓		Serie	87
2: 8.5 ↓	7: 9.9 ←				12: 9.1 →	17: 9.1 ↓			
3: 8.9 →	8: 10.7x ↓	Total	89	176	13: 7.9 ↗	18: 9.9 ←	Total	176	
4: 9.5 ↓	9: 8.9 ↖				14: 9.7 ←	19: 9.9 ↖			
5: 10.3x ↓	10: 9.4 ↑				15: 9.0 ↗	20: 8.4 ↙			

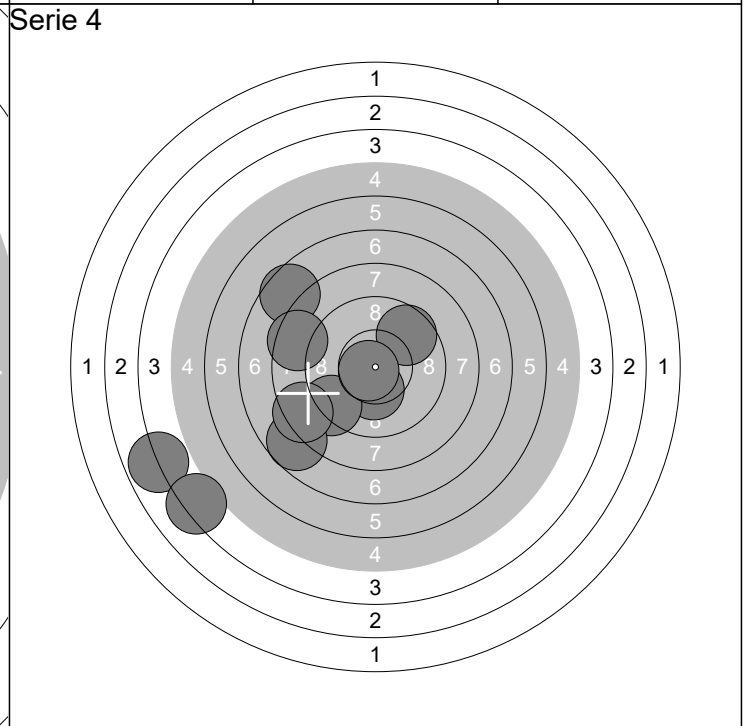
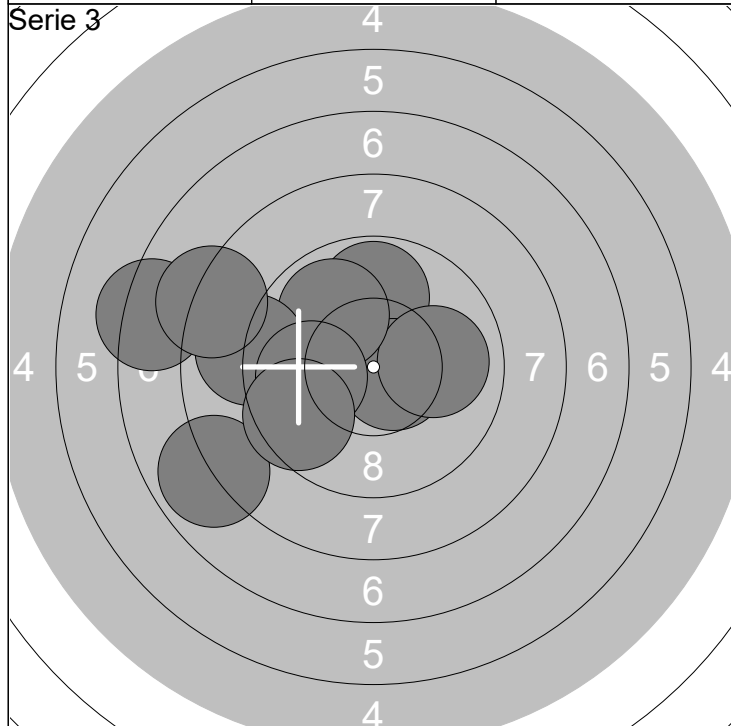

21: 9.8 ↑	26: 9.0 ←		Serie	87	31: 3.9 ←	36: 7.7 ↙		Serie	75
22: 10.6x →	27: 9.9 ←				32: 9.6 ↗	37: 7.6 ↖			
23: 10.0 →	28: 7.3 ←	Total	263	338	33: 10.3x ↓	38: 8.5 ←	Total	338	
24: 7.9 ←	29: 9.5 ←				34: 9.2 ←	39: 8.4 ↙			
25: 9.9 ↖	30: 8.1 ←				35: 4.2 ↙	40: 10.7x ↙			

Skjutlag

4

Tavla

9

Tage Gunnarsson

Rottne Industri Cup 2018

Karlslunda Ungdomsskyttefören

L11J

27.10.2018

Rottne Industri Cup 2018

Söraby SKF

Serie 1

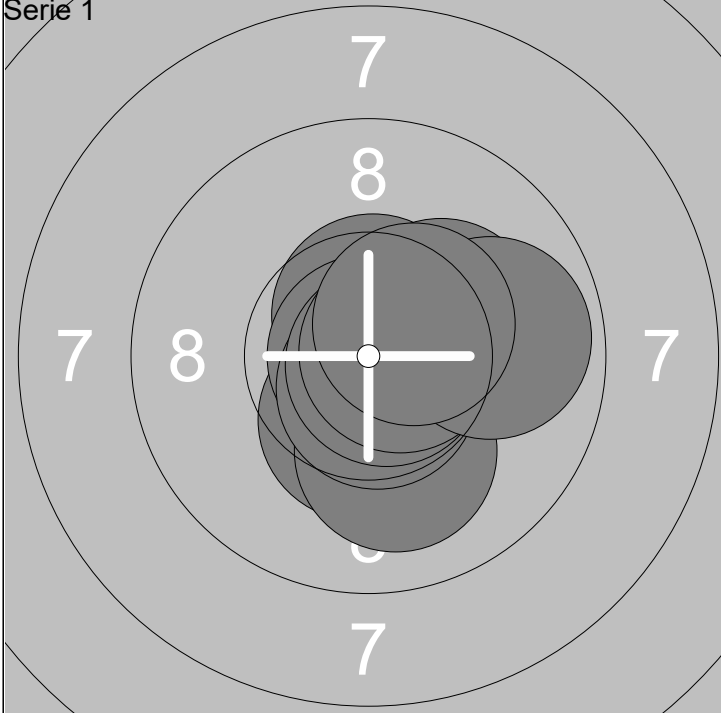

Serie 2

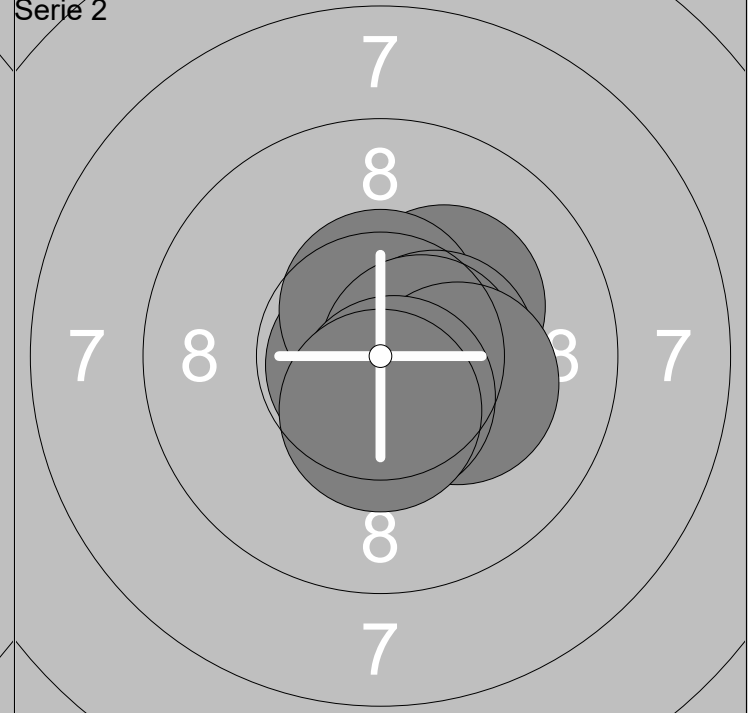

1: 10.4x ↓	6: 10.7x ↓
2: 10.1 ↓	7: 10.8x →
3: 10.6x ↑	8: 10.7x →
4: 10.2x ↗	9: 9.8 →
5: 10.9x	10: 10.5x ↗

Serie	99
Total	99

11: 10.8x ↙	16: 10.5x →
12: 10.4x →	17: 10.6x →
13: 10.5x ↗	18: 10.2x →
14: 10.2x ↗	19: 10.6x ↓
15: 10.5x ↑	20: 10.5x ↓

Serie	100
Total	199

Serie 3

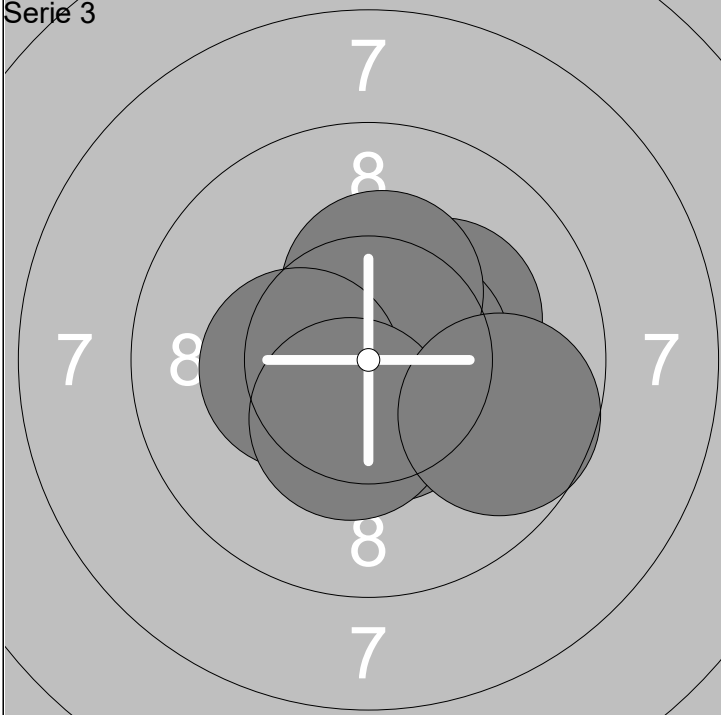

Serie 4

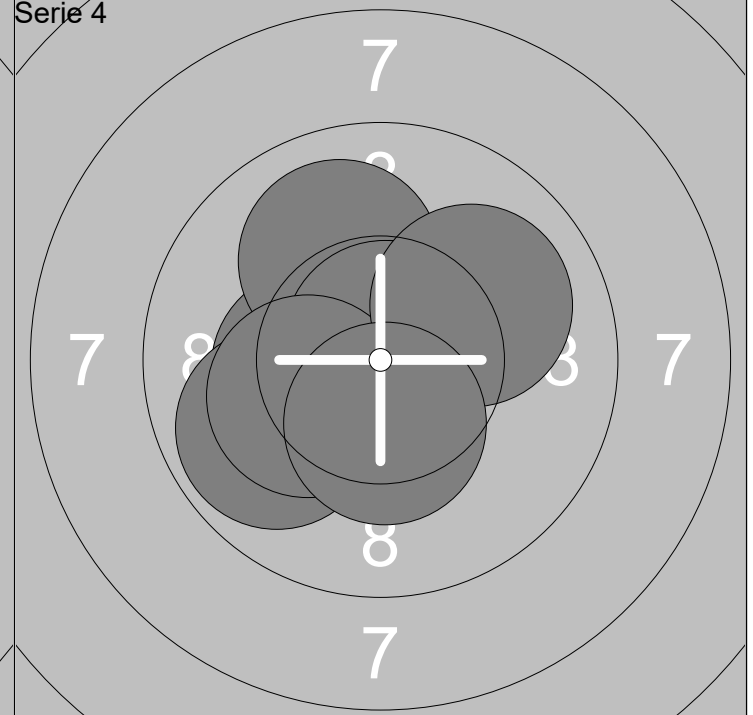

21: 10.2x ↗	26: 10.8x ↙
22: 10.6x ↗	27: 10.3x ↑
23: 10.6x ↓	28: 10.3x ←
24: 10.5x ↓	29: 10.4x ↓
25: 10.6x →	30: 9.7 →

Serie	99
Total	298

31: 10.5x ↙	36: 9.8 ↙
32: 10.3x ←	37: 10.8x ↑
33: 10.8x →	38: 10.2x ↙
34: 10.0 ↑	39: 10.0 ↗
35: 10.8x ↗	40: 10.4x ↓

Serie	99
Total	397

Rottne Industri Cup 2018

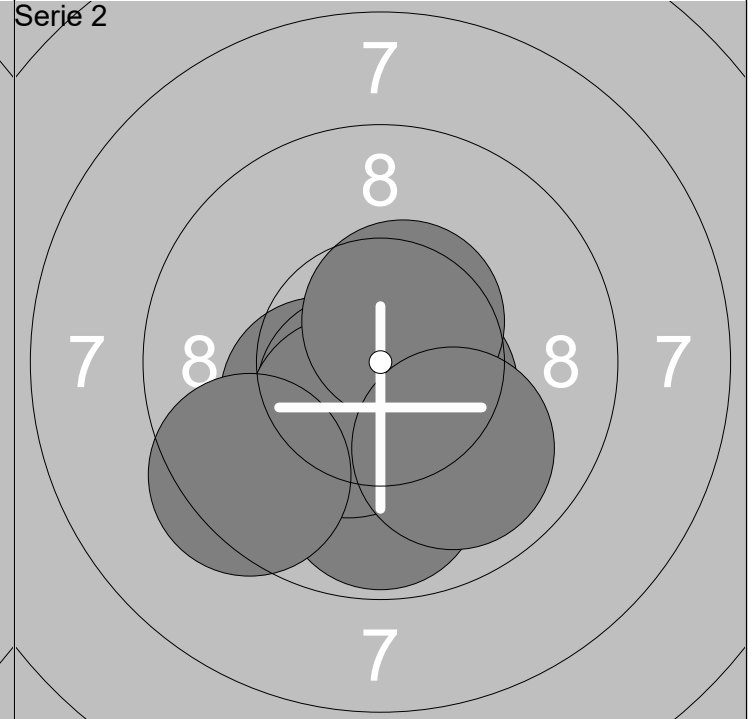
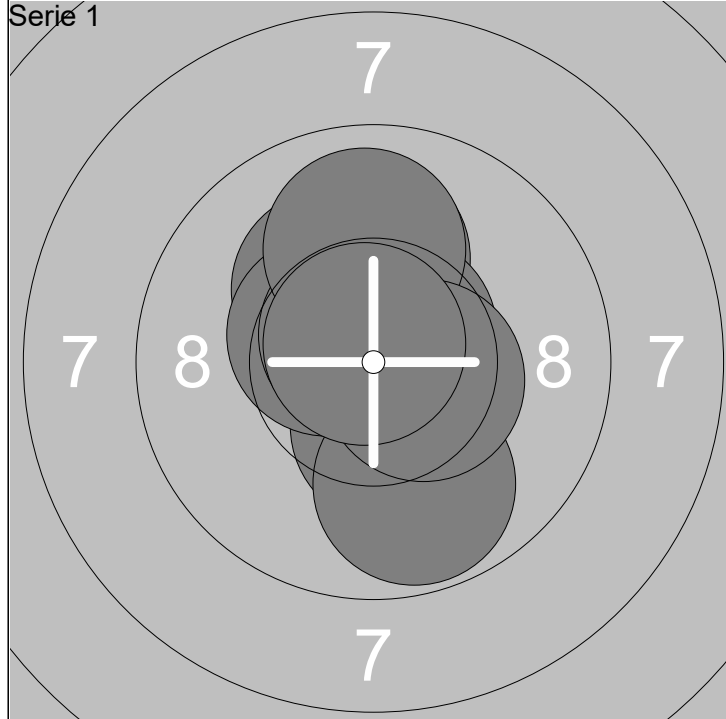

1: 10.2x ↗	6: 10.6x ↗	Serie	99
2: 10.4x ↓	7: 10.0 ↑		
3: 10.5x ↖	8: 9.8 ↓	Total	99
4: 10.0 ↑	9: 10.5x →		
5: 10.7x ↗	10: 10.8x ↗		

11: 10.6x ↙	16: 10.6x ↙	Serie	98
12: 10.6x ↘	17: 10.4x ↘		
13: 9.8 ↓	18: 10.5x ↗	Total	197
14: 10.5x ↘	19: 9.4 ↙		
15: 10.4x ↙	20: 10.0 ↘		

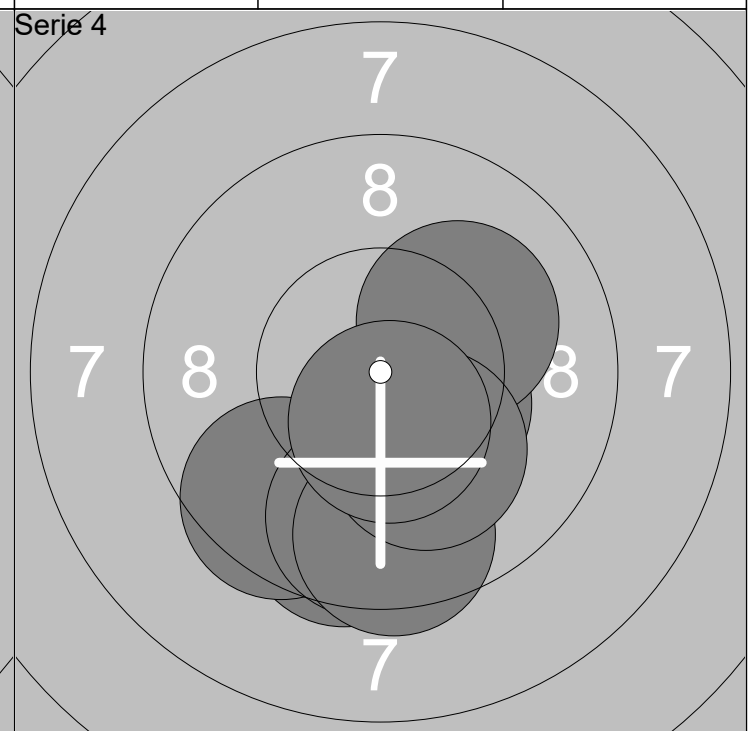
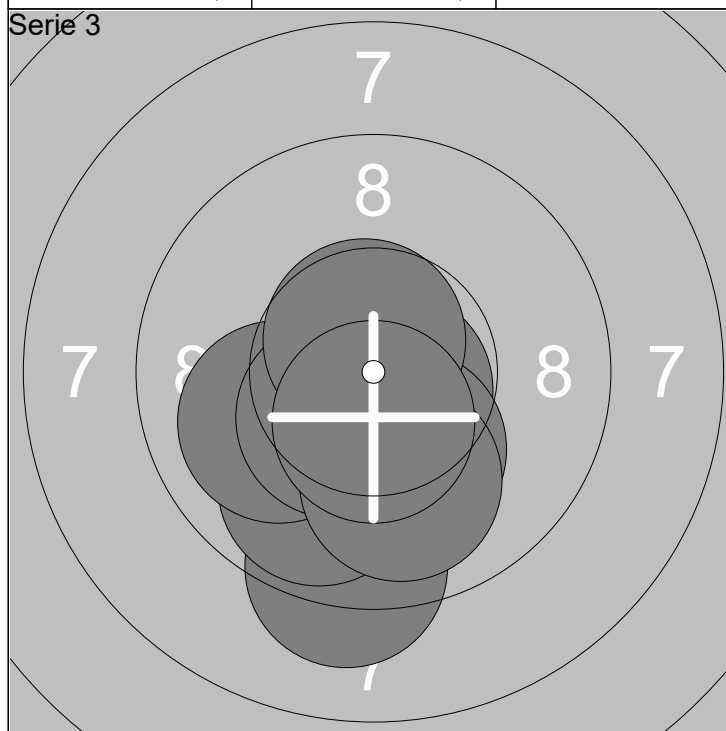

21: 9.2 ↓	26: 10.4x ↙	Serie	98
22: 9.8 ↓	27: 10.2x ↓		
23: 10.6x ↙	28: 10.7x ↗	Total	295
24: 10.0 ↖	29: 10.0 ↓		
25: 10.7x ↘	30: 10.5x ↓		

31: 9.6 ↓	36: 9.5 ↓	Serie	94
32: 9.8 ↓	37: 10.4x ↘		
33: 9.7 ↙	38: 10.1 ↗	Total	389
34: 9.5 ↙	39: 10.2x ↓		
35: 9.7 ↓	40: 10.5x ↓		

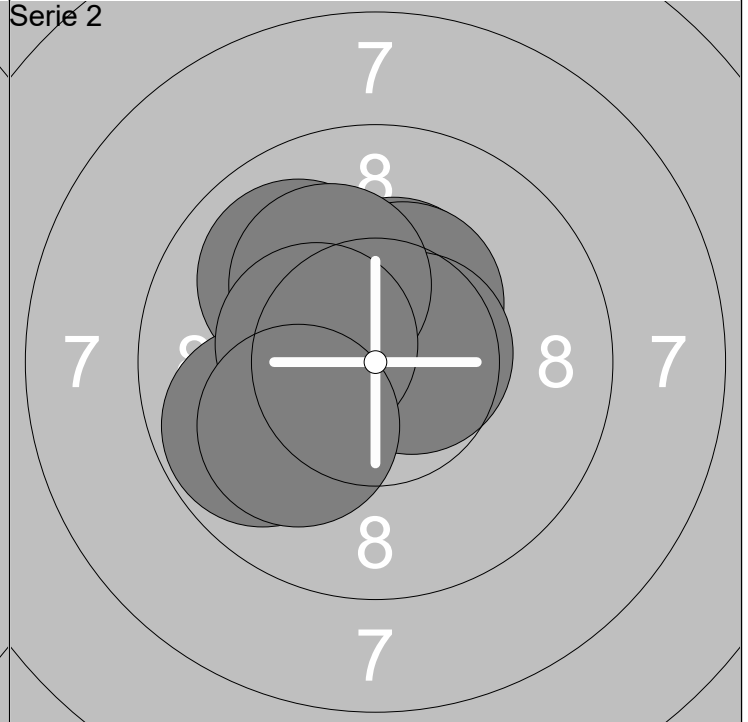
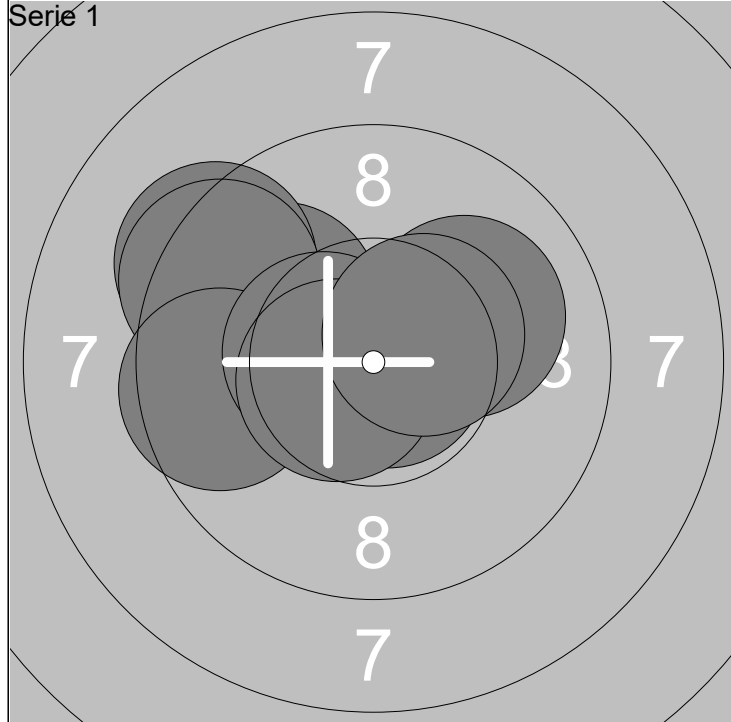

1: 10.9x →	6: 9.5 ←	Serie 97
2: 10.8x →	7: 10.5x ←	
3: 10.0 ↗	8: 10.6x ←	Total 97
4: 9.3 ↗	9: 10.1 ↗	
5: 9.4 ↖	10: 10.4x ↗	

11: 10.8x ↑	16: 10.6x →	Serie 99
12: 10.0 ↖	17: 10.2x ↖	
13: 10.7x ↑	18: 9.8 ←	Total 196
14: 10.4x ↑	19: 10.4x ←	
15: 10.4x ↑	20: 10.1 ↙	

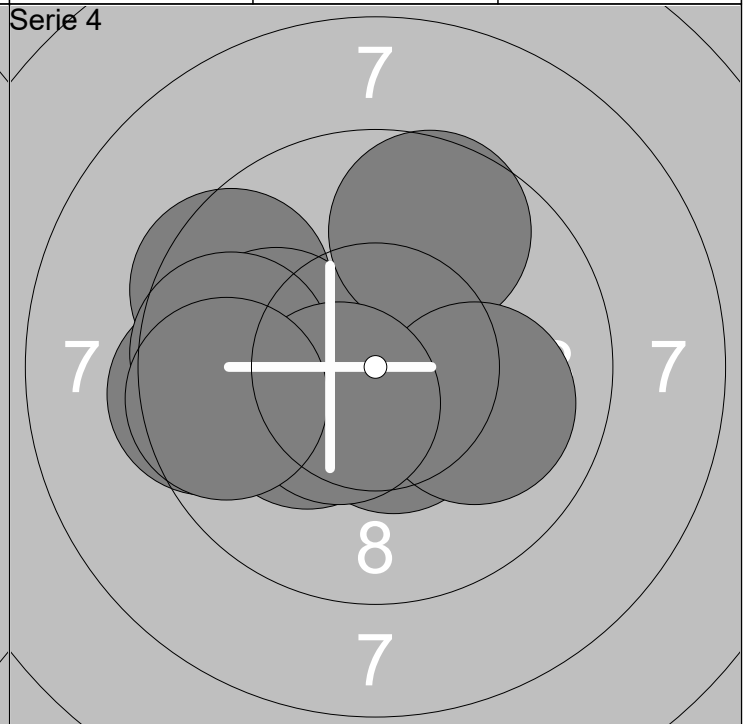
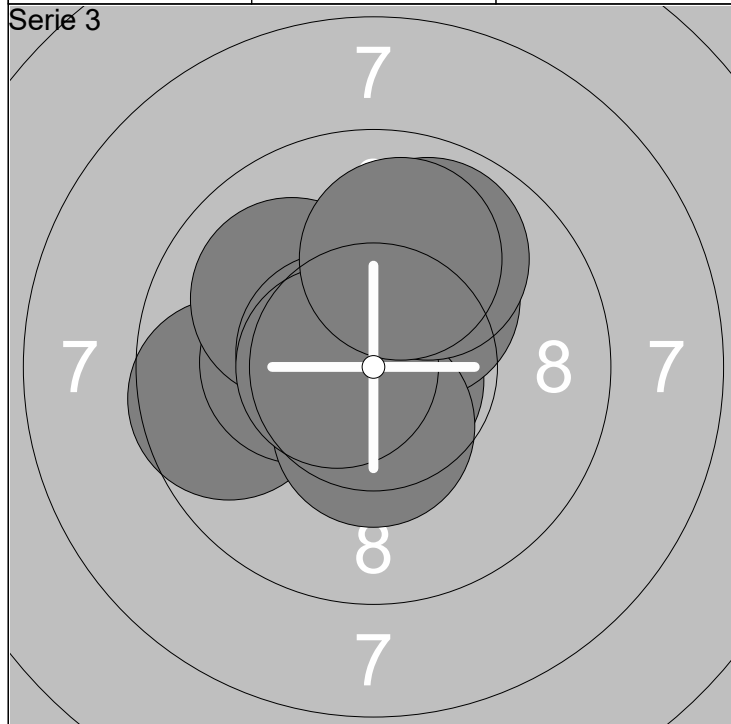

21: 9.7 ←	26: 10.6x ←	Serie 97
22: 10.8x ↘	27: 10.4x ↓	
23: 10.3x ←	28: 10.6x ←	Total 293
24: 10.2x ↗	29: 9.9 ↗	
25: 10.0 ↖	30: 9.9 ↑	

31: 9.5 ↖	36: 9.7 ↑	Serie 95
32: 10.1 ←	37: 9.7 ←	
33: 10.5x ↓	38: 10.0 →	Total 388
34: 9.4 ←	39: 10.5x ↘	
35: 10.2x ↙	40: 9.6 ←	

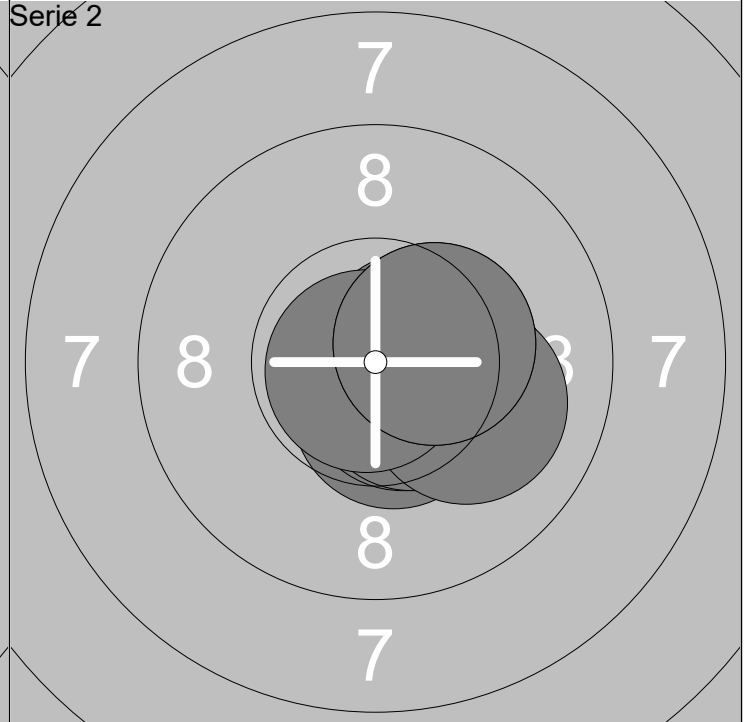
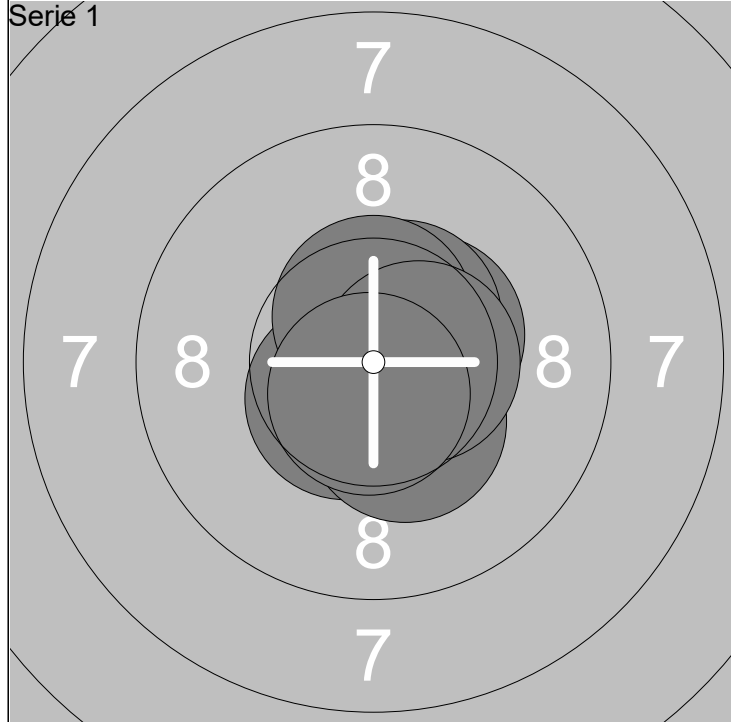

1: 10.5x ↗	6: 10.5x ↗	Serie 100
2: 10.7x ↑	7: 10.5x ↑	
3: 10.4x ↗	8: 10.4x ↓	Total 100
4: 10.8x →	9: 10.5x →	
5: 10.5x ↘	10: 10.7x ↓	

11: 10.5x ↓	16: 10.6x →	Serie 100
12: 10.6x ↓	17: 10.1 →	
13: 10.6x ↓	18: 10.8x ↘	Total 200
14: 10.7x →	19: 10.4x →	
15: 10.3x →	20: 10.4x →	

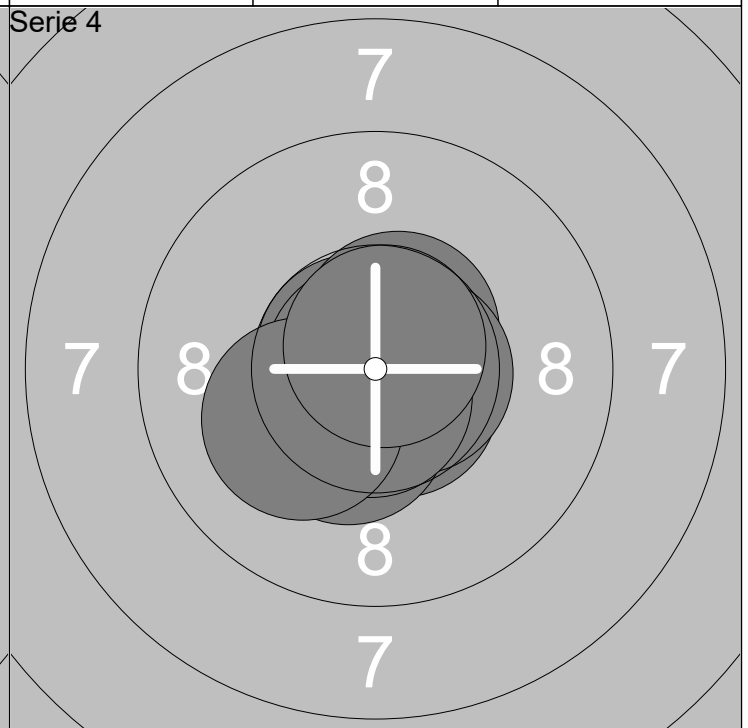
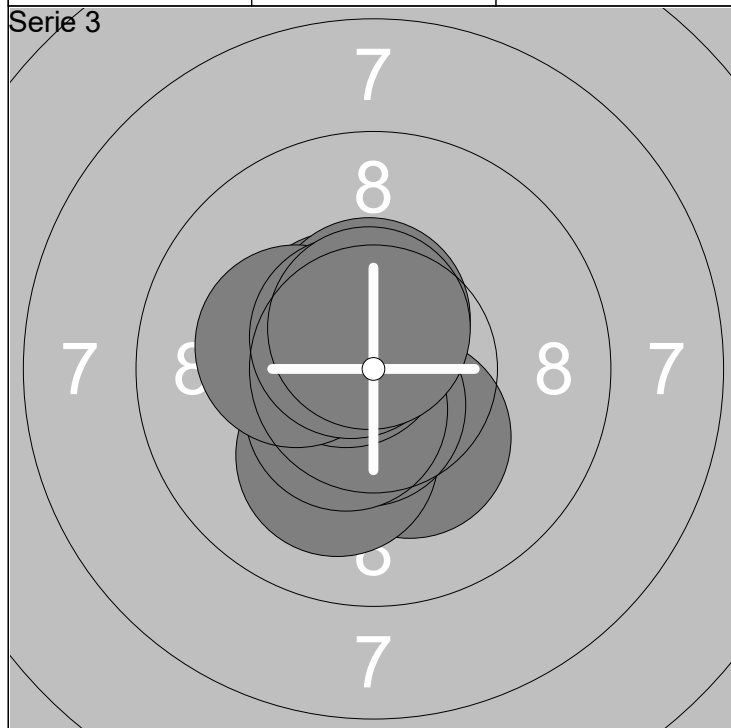

21: 10.3x ↓	26: 10.5x ↗	Serie 100
22: 10.1 ↓	27: 10.5x ↑	
23: 10.6x ↓	28: 10.2x ←	Total 300
24: 10.5x ↘	29: 10.6x ↗	
25: 10.6x ↖	30: 10.6x ↑	

31: 10.7x ↘	36: 10.6x →	Serie 100
32: 10.8x ↖	37: 10.9x ↖	
33: 10.6x ↓	38: 10.7x ↓	Total 400
34: 10.4x ↘	39: 10.2x ↖	
35: 10.6x ↗	40: 10.7x ↑	

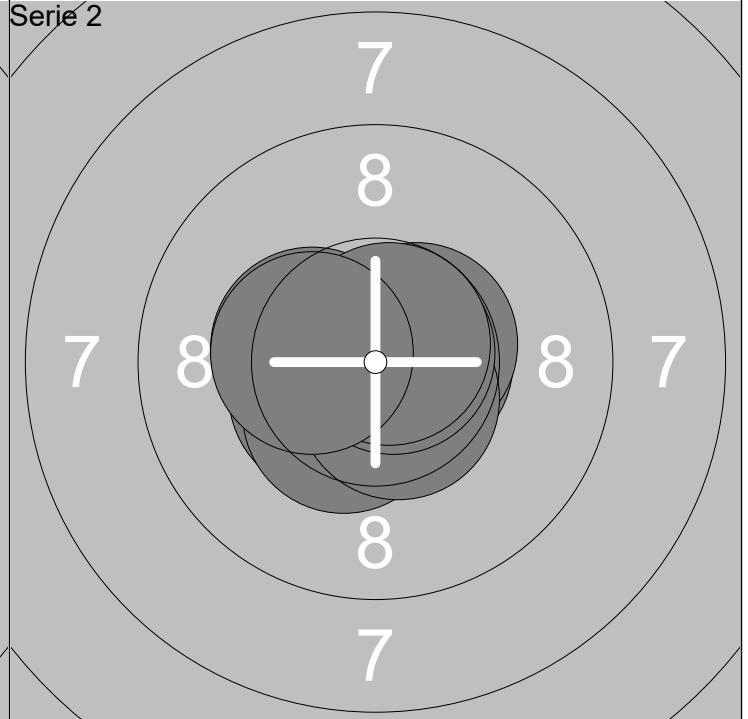
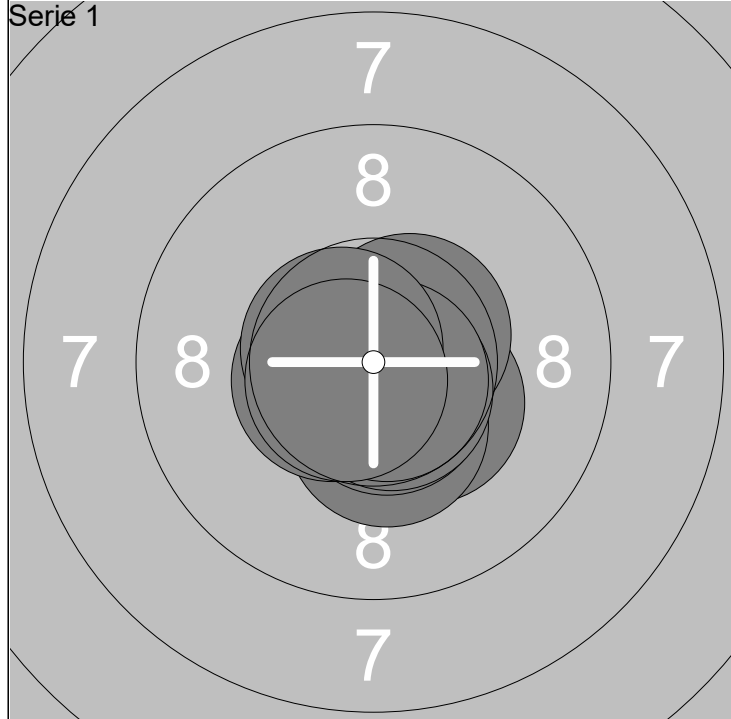

1: 10.8x ↓	6: 10.5x ←	Serie	100
2: 10.4x ↘	7: 10.7x ↓		
3: 10.6x ↗	8: 10.8x ↓	Total	100
4: 10.4x ↓	9: 10.6x ↗		
5: 10.6x ↓	10: 10.6x ↙		

11: 10.4x ←	16: 10.4x ↙	Serie	100
12: 10.5x ↙	17: 10.6x ↓		
13: 10.5x ↙	18: 10.8x ↗	Total	200
14: 10.6x →	19: 10.8x ↗		
15: 10.6x ↗	20: 10.4x ←		

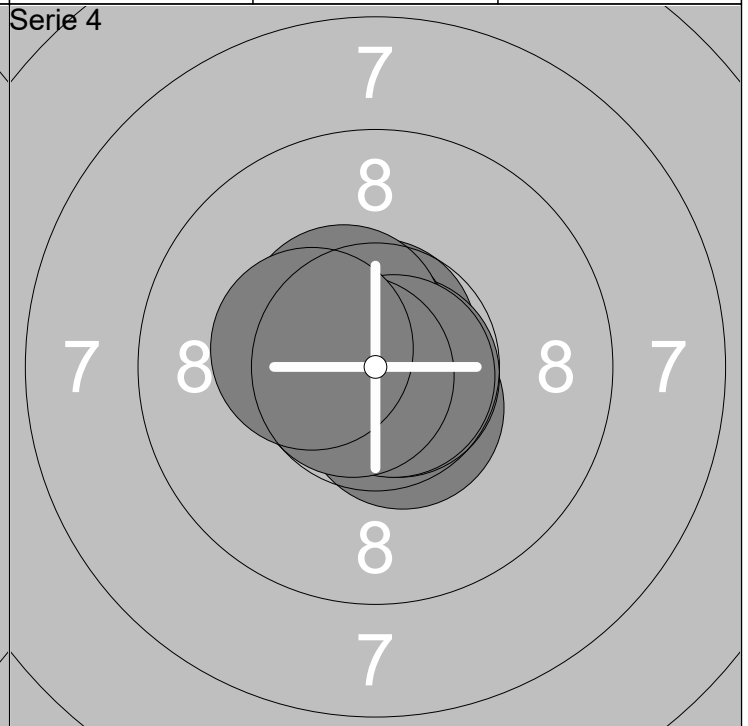
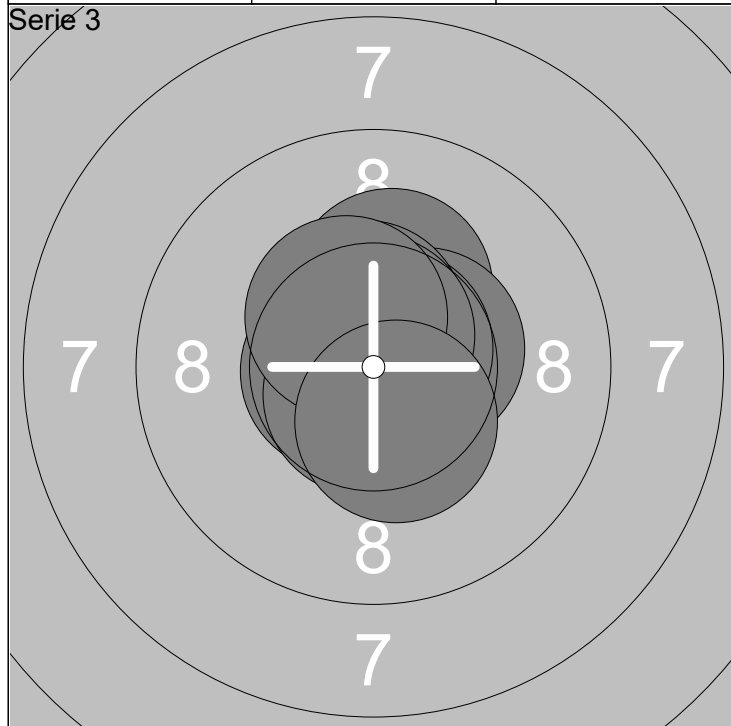

21: 10.3x ↑	26: 10.7x ↓	Serie	100
22: 10.5x ↗	27: 10.6x ↑		
23: 10.7x ←	28: 10.7x ↑	Total	300
24: 10.7x ↗	29: 10.4x ↗		
25: 10.7x ↓	30: 10.5x ↓		

31: 10.7x ↑	36: 10.6x ↗	Serie	100
32: 10.8x ↓	37: 10.5x ↗		
33: 10.5x ↓	38: 10.8x ↘	Total	400
34: 10.5x ↗	39: 10.7x ←		
35: 10.7x →	40: 10.4x ←		

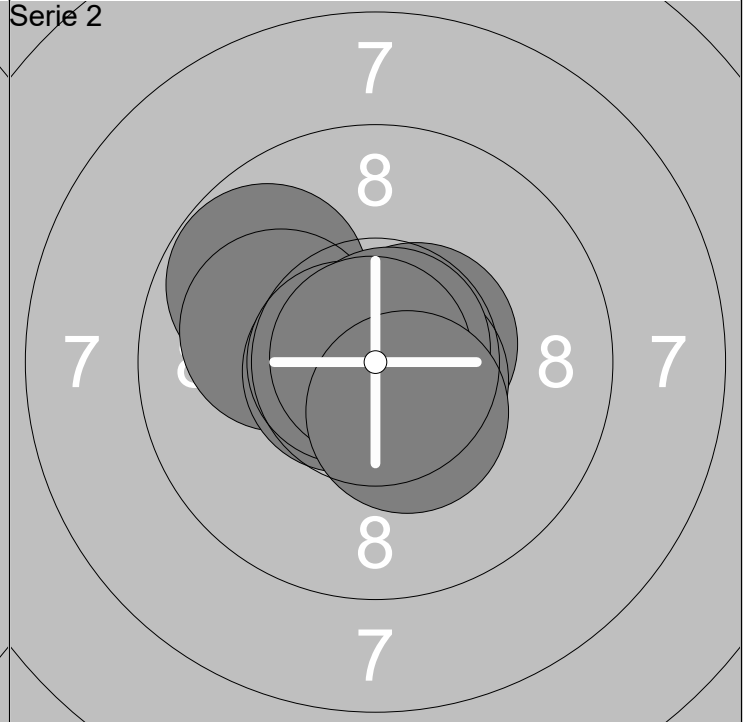
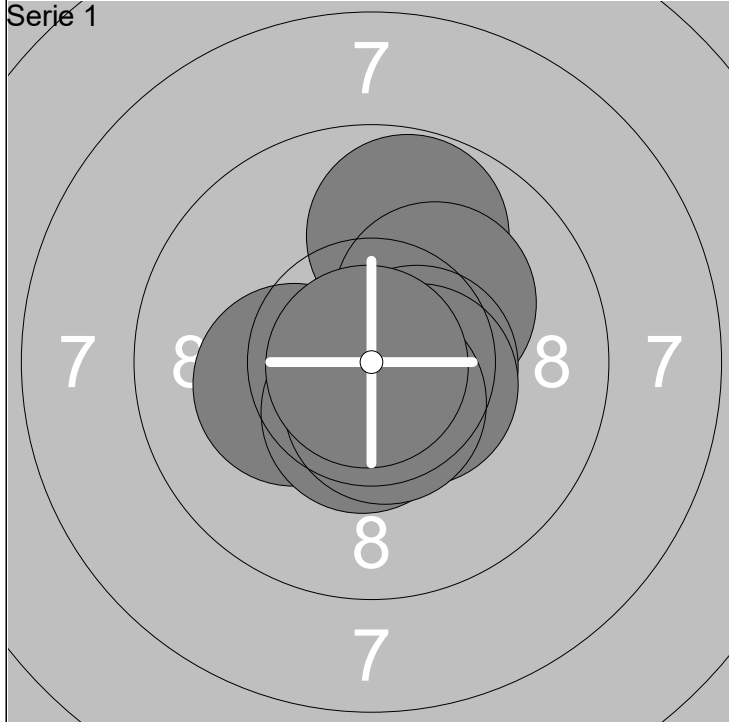

1: 10.7x ↓	6: 10.2x ←	Serie	99
2: 9.8 ↑	7: 10.7x ↓		
3: 10.2x ↗	8: 10.5x ↓	Total	99
4: 10.6x →	9: 10.6x ↓		
5: 10.5x ↘	10: 10.9x ↙		

11: 9.8 ↖	16: 10.6x ↘	Serie	99
12: 10.6x ↗	17: 10.7x ←		
13: 10.1 ←	18: 10.8x ↗	Total	198
14: 10.8x ↓	19: 10.9x ↗		
15: 10.7x ←	20: 10.4x ↓		

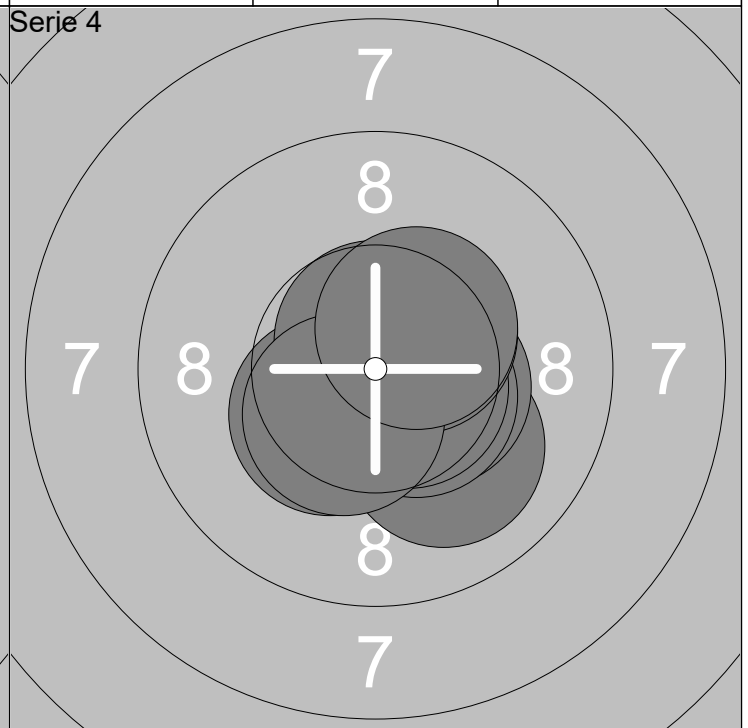
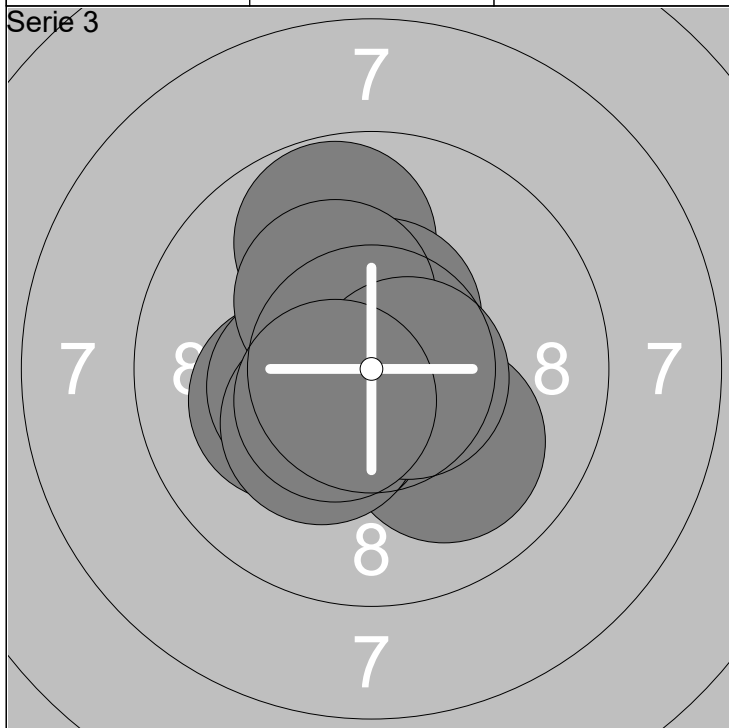

21: 10.0 ↘	26: 10.4x ←	Serie	99
22: 10.4x ↙	27: 10.3x ↗		
23: 10.2x ←	28: 10.3x ↙	Total	297
24: 9.8 ↑	29: 10.6x →		
25: 10.5x ↑	30: 10.5x ↙		

31: 10.0 ↓	36: 10.6x ↘	Serie	100
32: 10.4x →	37: 10.7x ↑		
33: 10.6x ↓	38: 10.5x ↗	Total	397
34: 10.5x ↓	39: 10.5x ↙		
35: 10.4x ↙	40: 10.4x ↗		

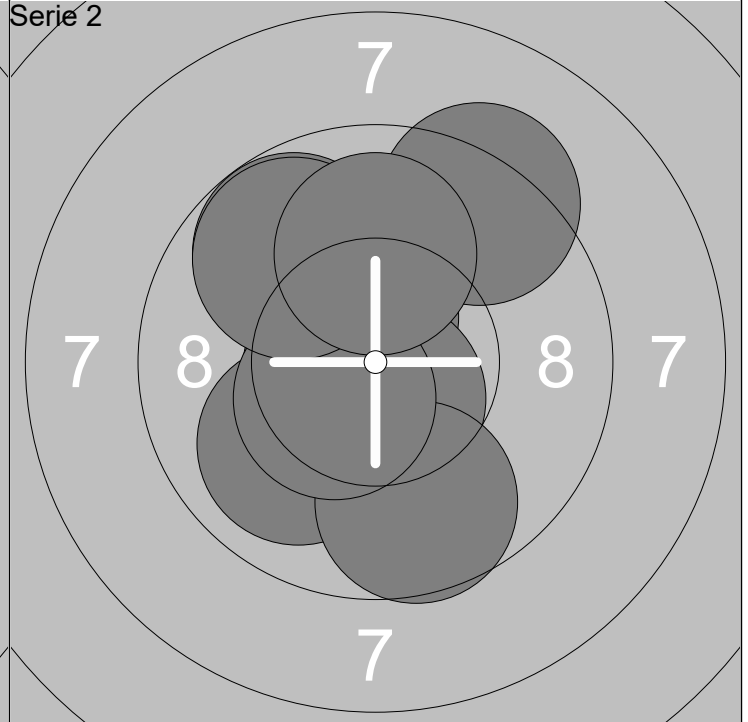
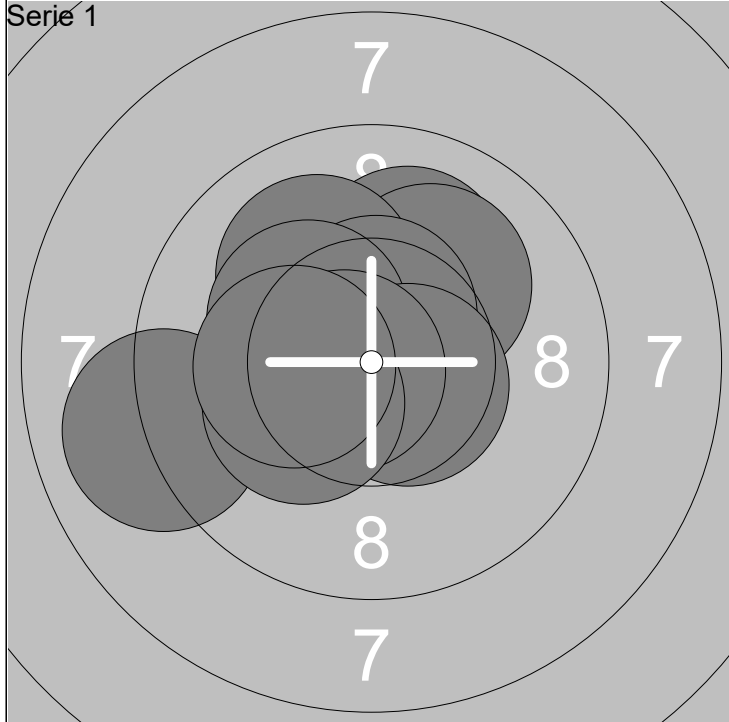

1: 10.0 ↗	6: 10.3x ↘	Serie 99
2: 10.1 ↗	7: 10.6x ↘	
3: 9.0 ←	8: 10.7x ←	Total 99
4: 10.1 ↗	9: 10.2x ←	
5: 10.5x ↑	10: 10.3x ←	

11: 9.3 ↗	16: 9.6 ↓	Serie 96
12: 10.5x ↑	17: 10.5x ↘	
13: 10.0 ↘	18: 9.8 ↗	Total 195
14: 10.7x ←	19: 9.8 ↗	
15: 10.6x ↓	20: 10.0 ↑	

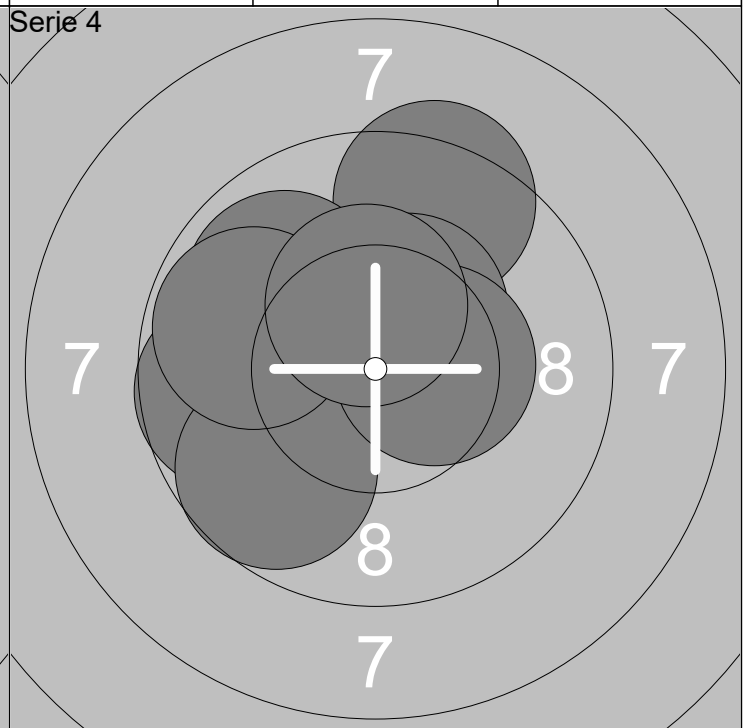
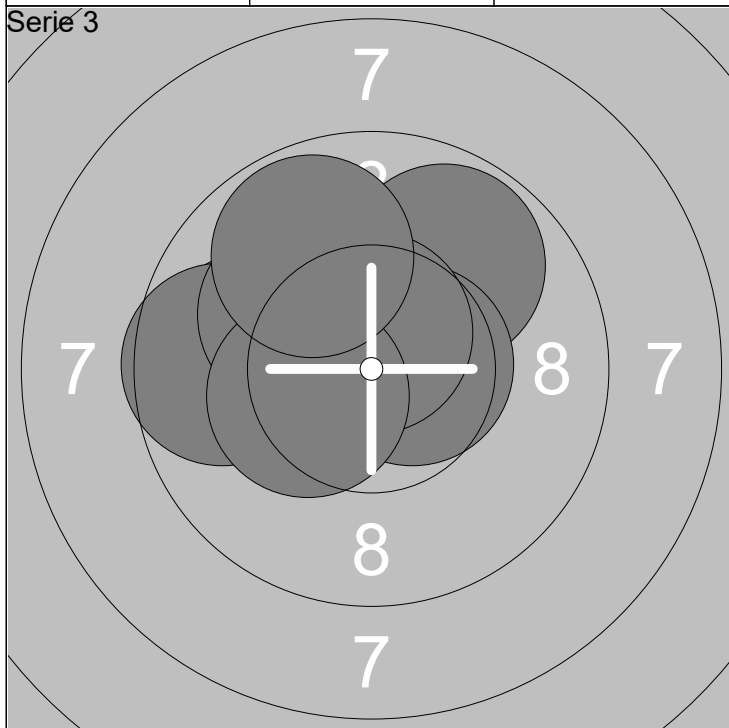

21: 10.5x ↘	26: 10.6x →	Serie 96
22: 9.9 ←	27: 10.1 ↘	
23: 10.6x ↑	28: 10.6x ↑	Total 291
24: 9.6 ←	29: 10.3x ←	
25: 9.8 ↗	30: 9.8 ↗	

31: 10.3x ↘	36: 9.7 ←	Serie 95
32: 10.4x ←	37: 9.7 ↘	
33: 9.4 ↑	38: 9.8 ←	Total 386
34: 10.4x ↗	39: 10.4x →	
35: 9.9 ↘	40: 10.4x ↑	

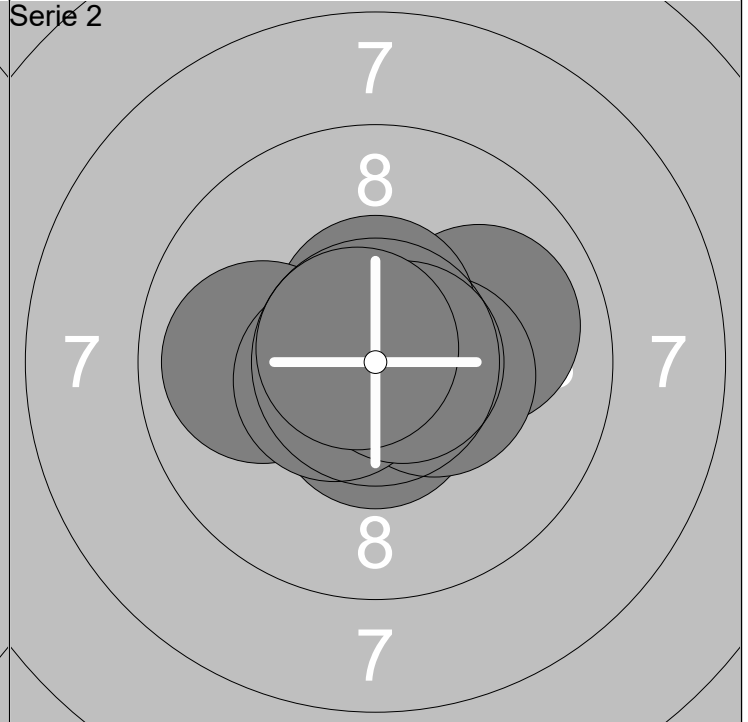
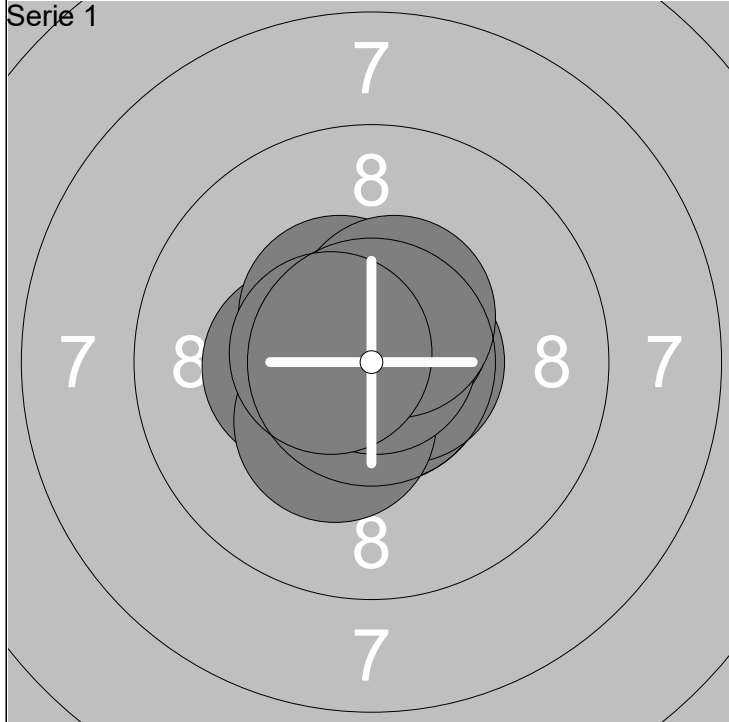

1: 10.4x ←	6: 10.6x ↗	Serie	100
2: 10.8x ↓	7: 10.3x ↘		
3: 10.8x ↘	8: 10.9x ↗	Total	100
4: 10.5x ↗	9: 10.5x ↗		
5: 10.7x →	10: 10.6x ←		

11: 10.0 →	16: 10.6x ↑	Serie	99
12: 10.5x ↓	17: 9.9 ←		
13: 10.9x ↗	18: 10.5x ←	Total	199
14: 10.7x ↑	19: 10.7x →		
15: 10.4x →	20: 10.7x ↖		

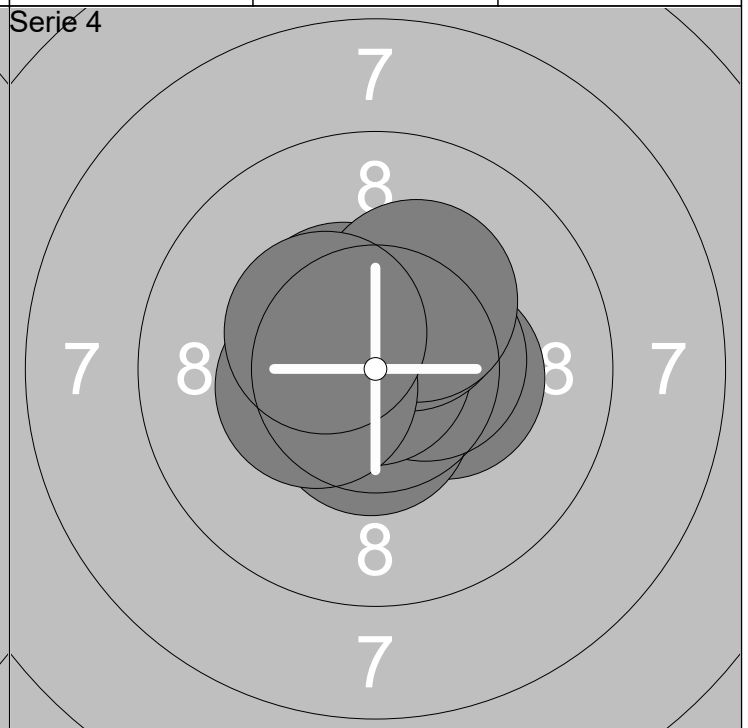
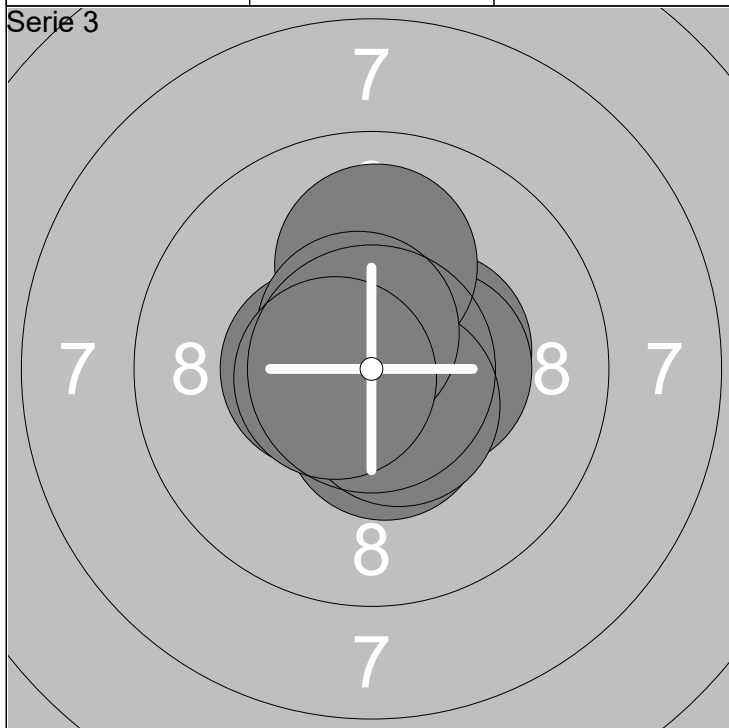

21: 10.7x ↖	26: 10.5x ↘	Serie	100
22: 10.4x →	27: 10.0 ↑		
23: 10.9x ↗	28: 10.5x ←	Total	299
24: 10.4x →	29: 10.6x ↗		
25: 10.5x ↓	30: 10.6x ←		

31: 10.6x →	36: 10.9x ↖	Serie	100
32: 10.3x →	37: 10.4x ↗		
33: 10.6x ↓	38: 10.3x ↗	Total	399
34: 10.5x ↗	39: 10.4x ←		
35: 10.5x →	40: 10.4x ↖		

Serie 1

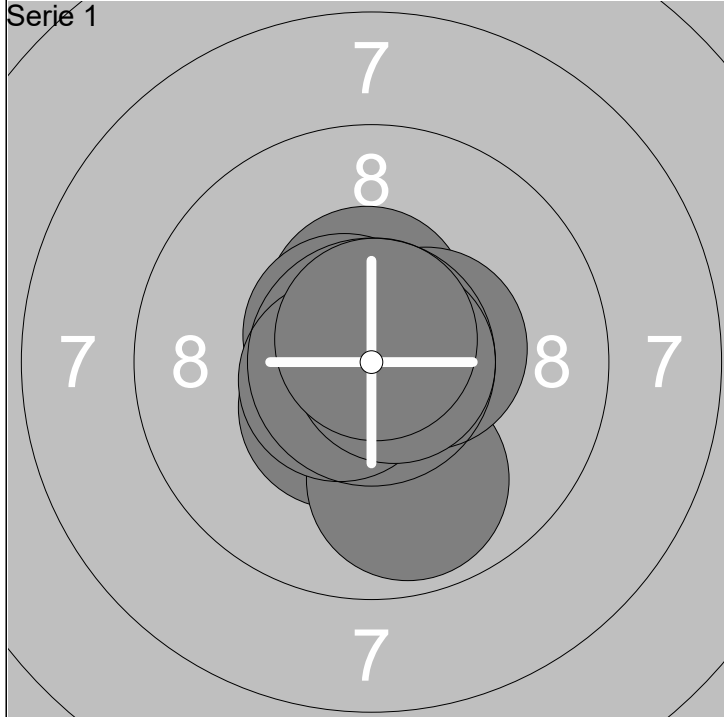

Serie 2

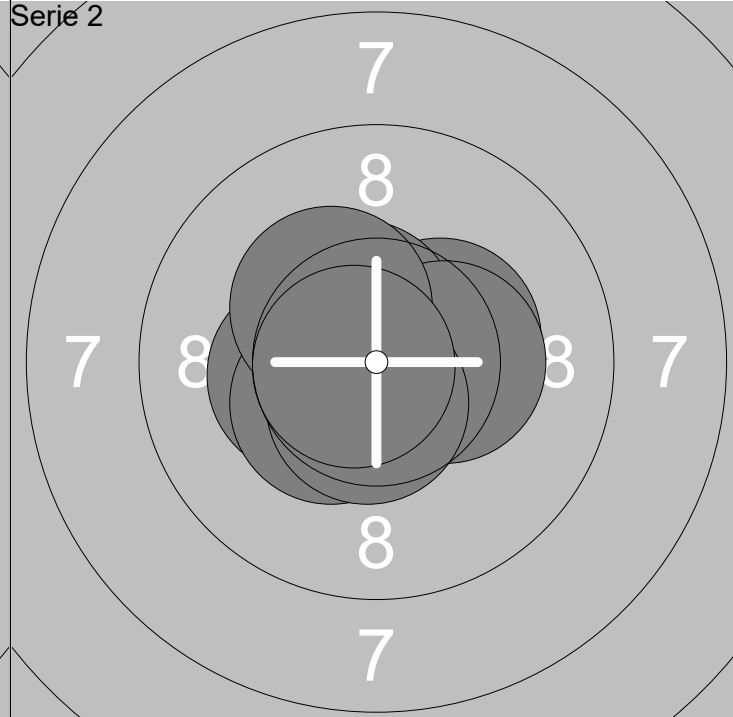

1: 10.5x ↙
2: 10.7x ←
3: 10.5x ↑
4: 10.6x ↖
5: 9.9 ↓

6: 10.4x →
7: 10.9x ←
8: 10.6x ↖
9: 10.7x →
10: 10.8x ↑

Serie 99
Total 99

11: 10.8x ↗
12: 10.7x ↑
13: 10.4x ←
14: 10.4x ↙
15: 10.4x →

16: 10.5x ↗
17: 10.4x →
18: 10.3x ↖
19: 10.6x ↓
20: 10.7x ←

Serie 100
Total 199

Serie 3

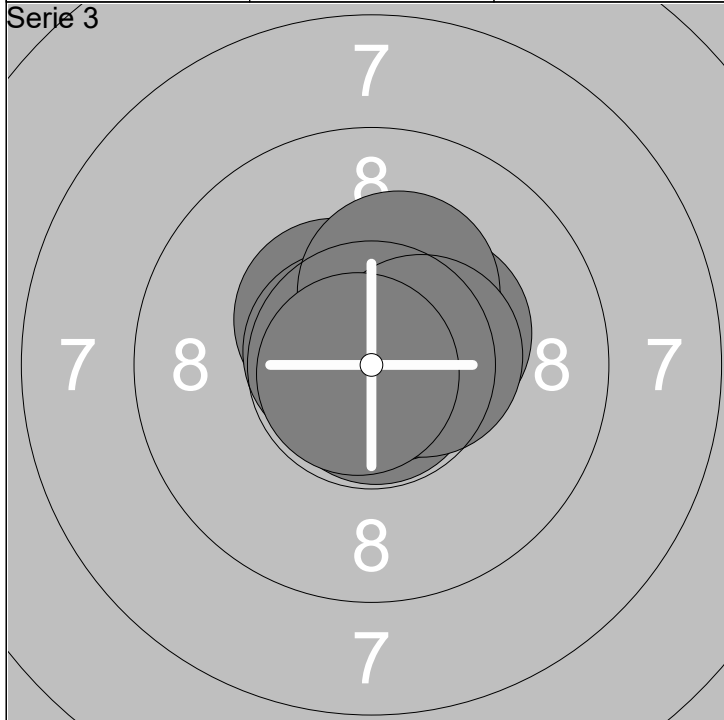

Serie 4

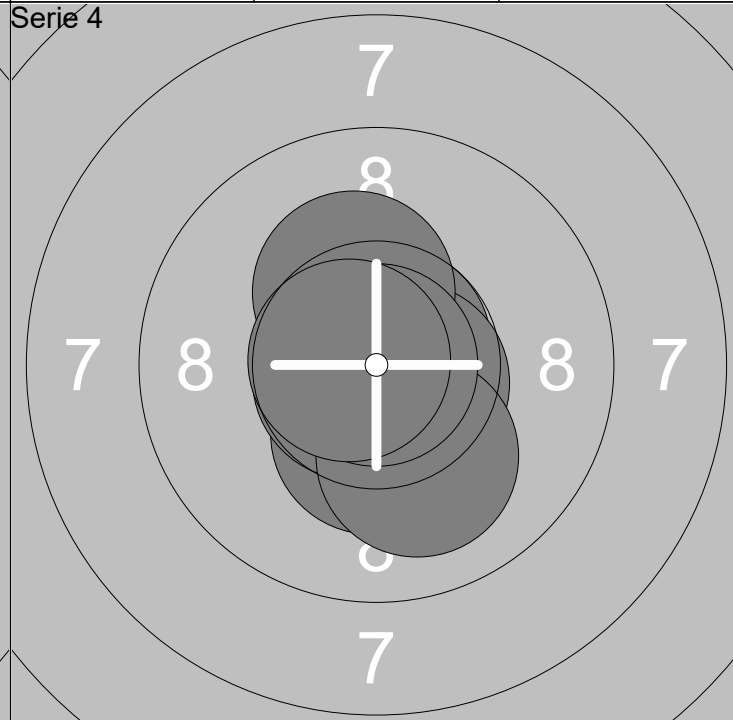

21: 10.8x ↓
22: 10.8x →
23: 10.3x ↗
24: 10.5x ↗
25: 10.7x ↖

26: 10.4x ↖
27: 10.7x ↖
28: 10.3x ↑
29: 10.5x →
30: 10.8x ↖

Serie 100
Total 299

31: 10.8x ↗
32: 10.7x ↖
33: 10.7x ↗
34: 10.3x ↓
35: 10.6x ↘

36: 10.3x ↗
37: 10.7x ↖
38: 10.1 ↓
39: 10.9x
40: 10.7x ←

Serie 100
Total 399

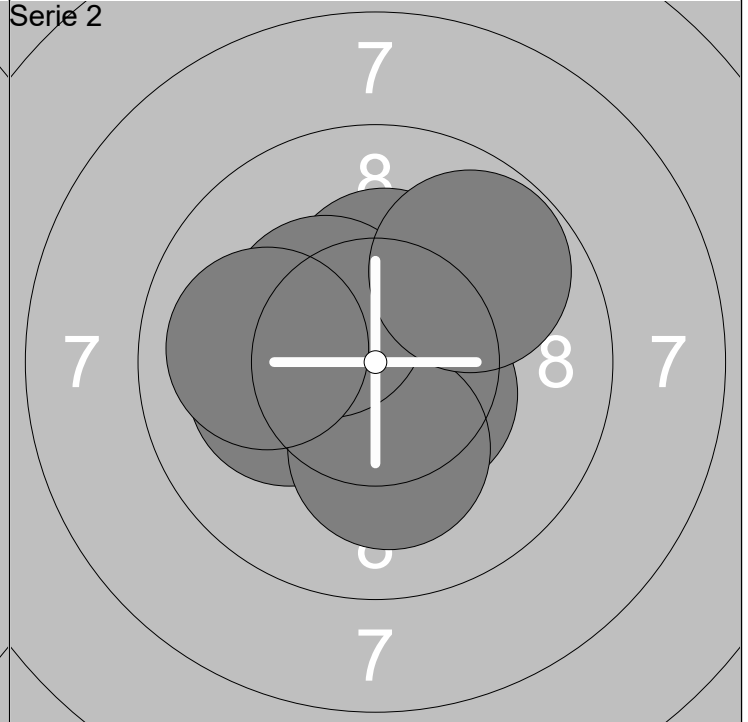
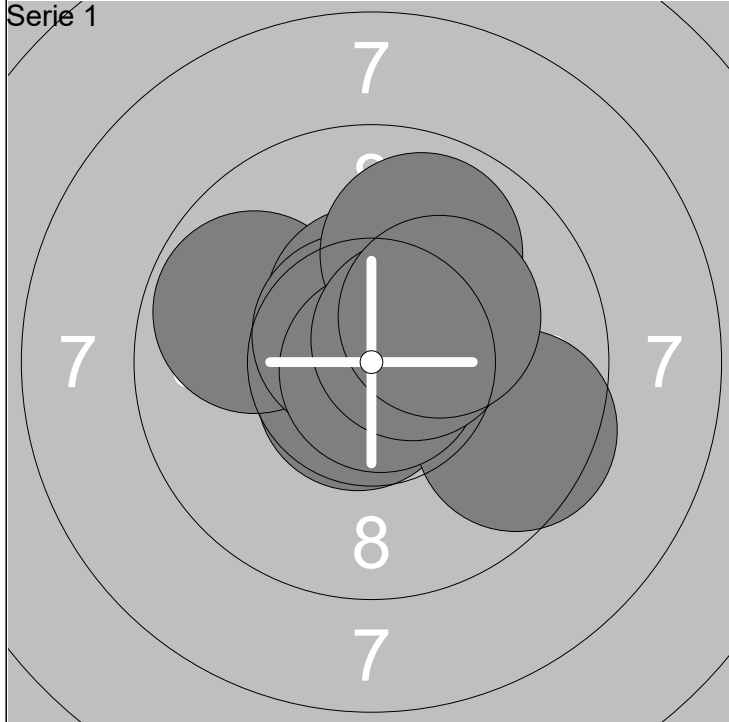

1: 10.7x ↙	6: 10.6x ↗	Serie	97
2: 9.8 ↖	7: 9.9 ↗		
3: 9.5 ↘	8: 10.8x ↘	Total	97
4: 10.5x ↑	9: 10.5x ↗		
5: 10.7x ↑	10: 10.2x ↗		

11: 10.3x ←	16: 10.2x ←	Serie	99
12: 10.3x ↑	17: 10.2x ↓		
13: 10.5x ↗	18: 10.4x ↖	Total	196
14: 10.6x →	19: 10.0 ←		
15: 10.5x ↘	20: 9.8 ↗		

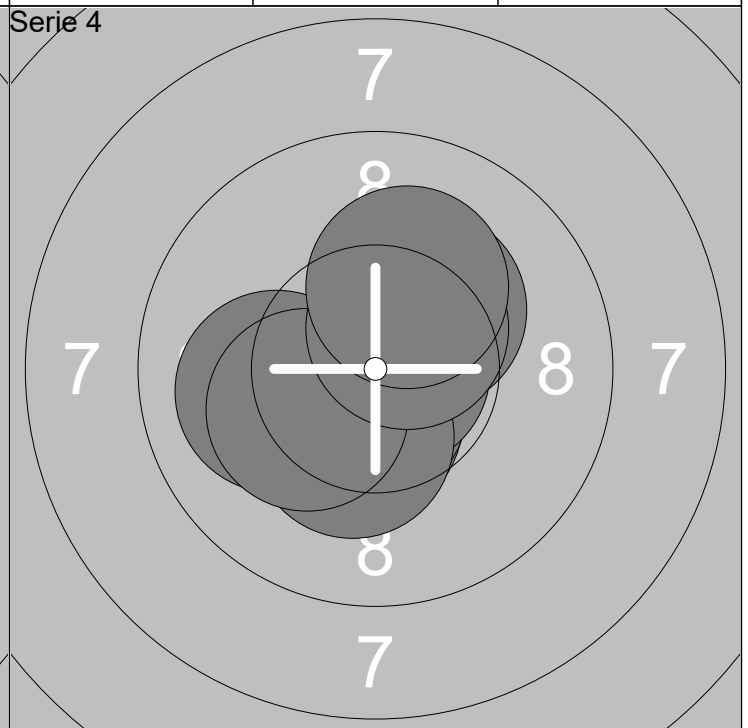
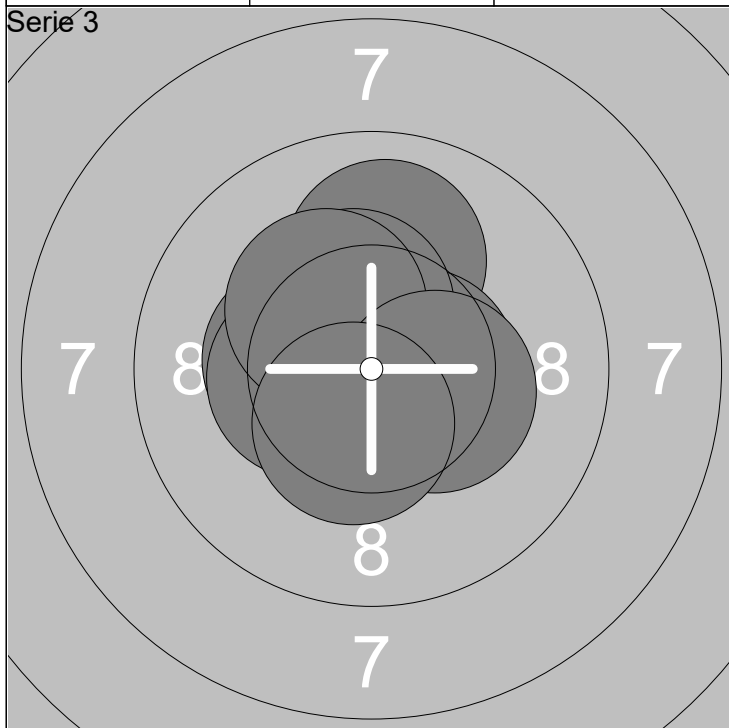

21: 10.3x ←	26: 10.8x ←	Serie	100
22: 10.8x ↗	27: 10.4x ←		
23: 10.0 ↑	28: 10.3x ↗	Total	296
24: 10.6x →	29: 10.3x →		
25: 10.4x ↑	30: 10.4x ↓		

31: 10.3x ↗	36: 10.8x →	Serie	100
32: 10.3x ↗	37: 10.3x ↓		
33: 10.5x ↓	38: 10.3x ↖	Total	396
34: 10.6x ↓	39: 10.5x ↗		
35: 10.0 ←	40: 10.2x ↑		

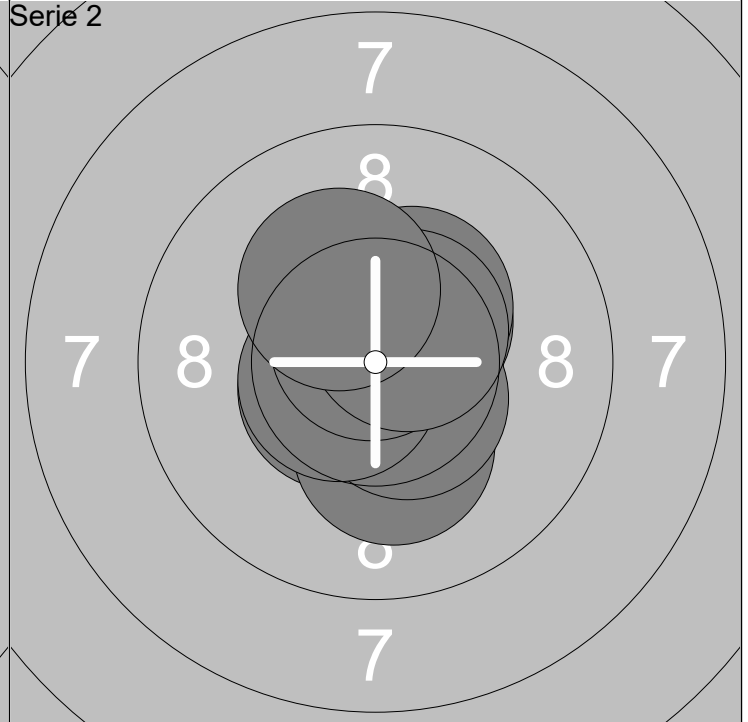
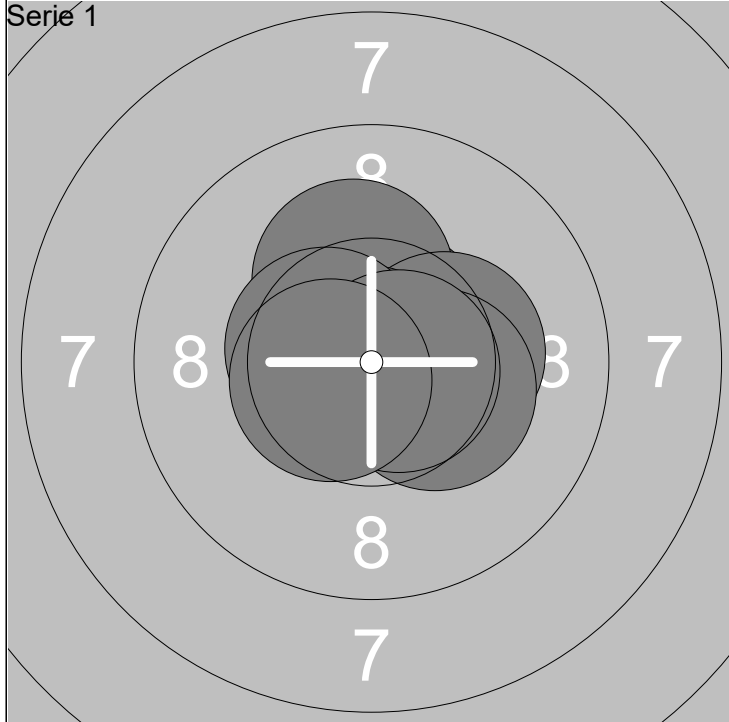

1: 10.6x ↖	6: 10.3x →	Serie	100
2: 10.6x ↗	7: 10.8x ←		
3: 10.2x ↑	8: 10.5x ←	Total	100
4: 10.3x →	9: 10.7x →		
5: 10.9x ↙	10: 10.6x ←		

11: 10.5x ↙	16: 10.5x ↘	Serie	100
12: 10.2x ↓	17: 10.6x ←		
13: 10.5x ↗	18: 10.7x ↑	Total	200
14: 10.7x ↘	19: 10.5x ↗		
15: 10.4x ↗	20: 10.2x ↖		

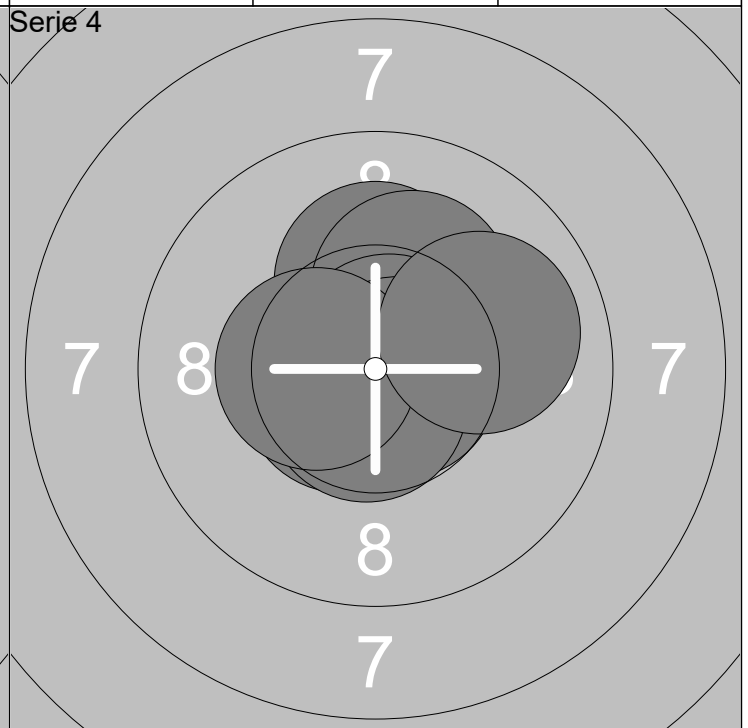
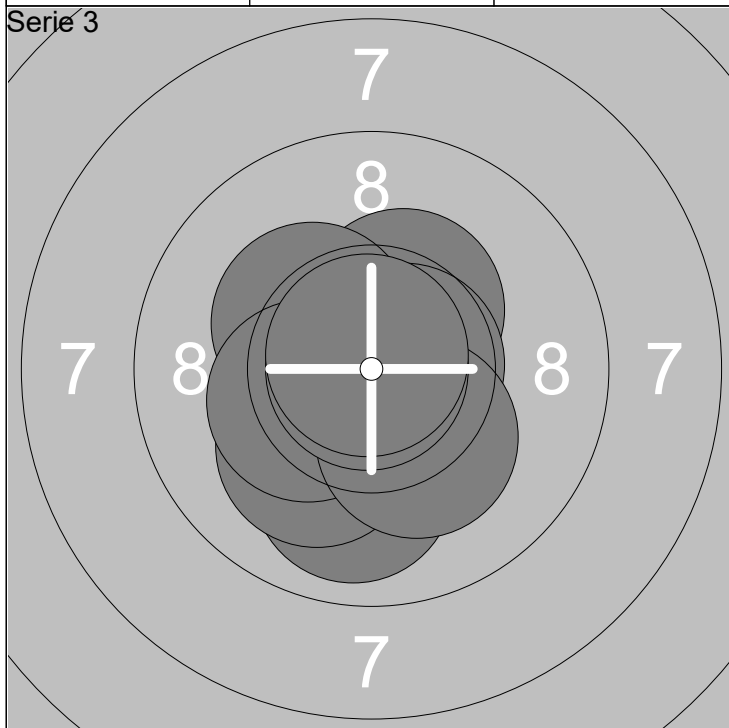

21: 10.4x ↗	26: 10.3x ↖	Serie	99
22: 10.7x →	27: 10.3x ←		
23: 9.9 ↓	28: 10.2x ↘	Total	299
24: 10.6x ↙	29: 10.9x ←		
25: 10.1 ↙	30: 10.8x ↗		

31: 10.7x ↗	36: 10.8x ↗	Serie	100
32: 10.2x ↑	37: 10.7x →		
33: 10.2x ↗	38: 10.7x ↓	Total	399
34: 10.8x ↓	39: 10.4x ←		
35: 10.6x ↙	40: 10.0 →		

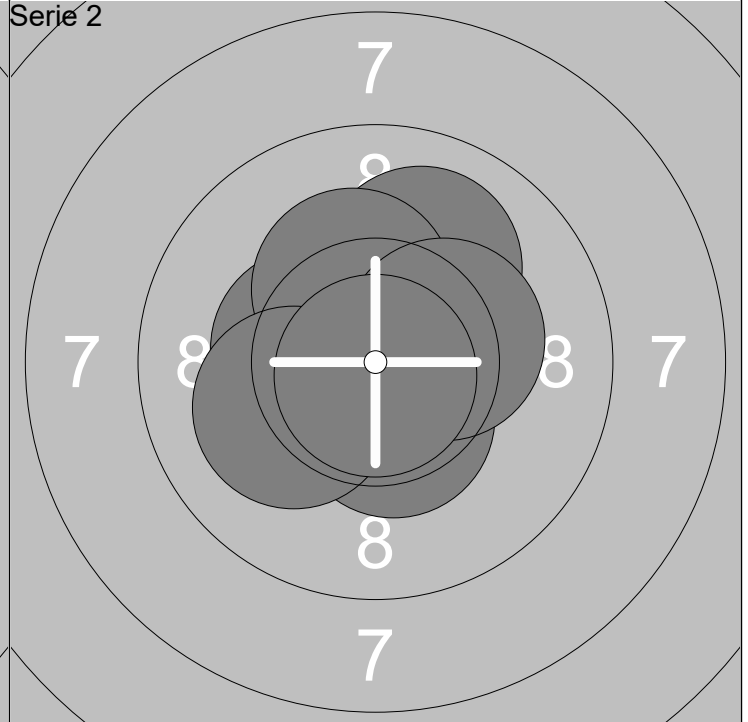
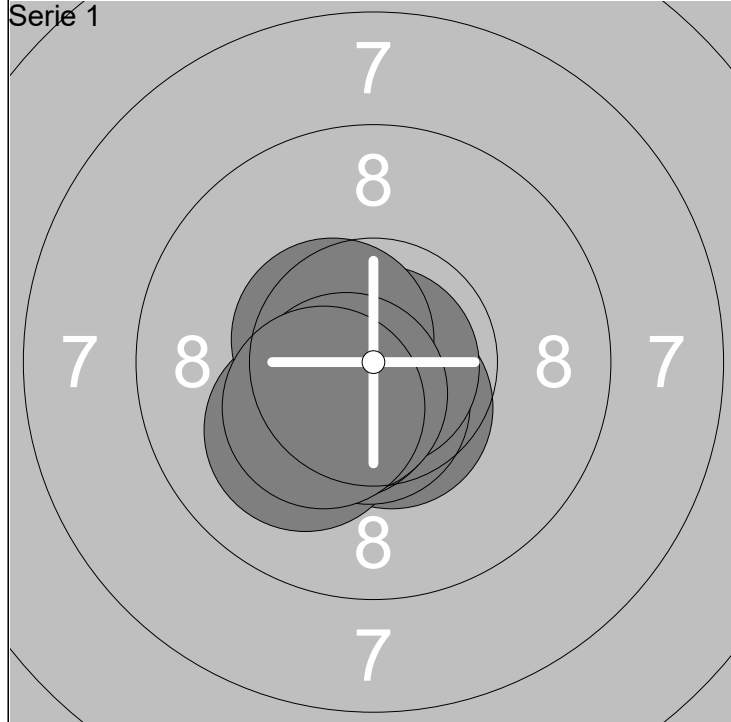

1: 10.5x ↓	6: 10.5x ↙	Serie	100
2: 10.5x ↙	7: 10.9x ↓		
3: 10.1 ↙	8: 10.5x ↗	Total	100
4: 10.8x ↙	9: 10.6x ↓		
5: 10.6x ↓	10: 10.4x ↙		

11: 10.6x ↗	16: 10.4x ↓	Serie	100
12: 10.6x ↓	17: 10.3x ↗		
13: 10.0 ↗	18: 10.3x →	Total	200
14: 10.4x ↙	19: 10.1 ↙		
15: 10.7x ↓	20: 10.8x ↓		

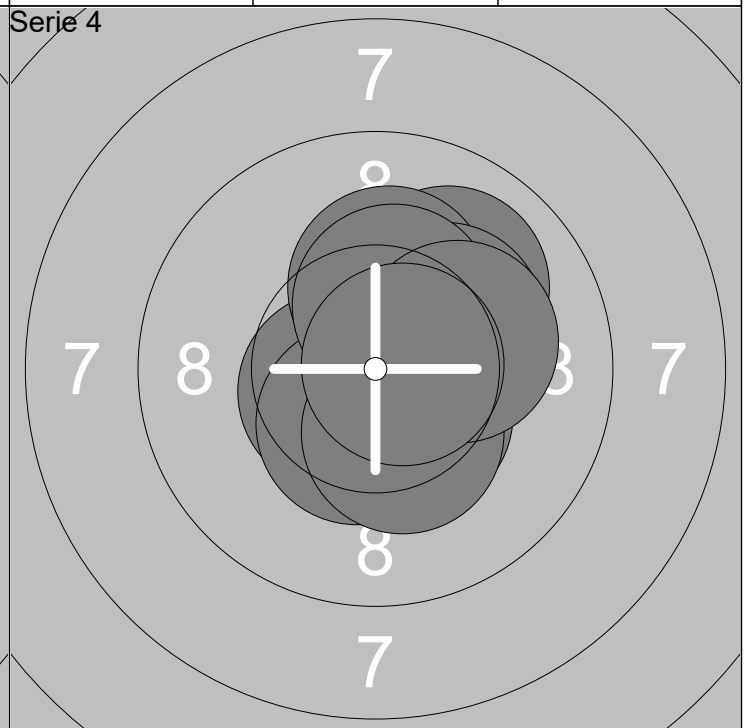
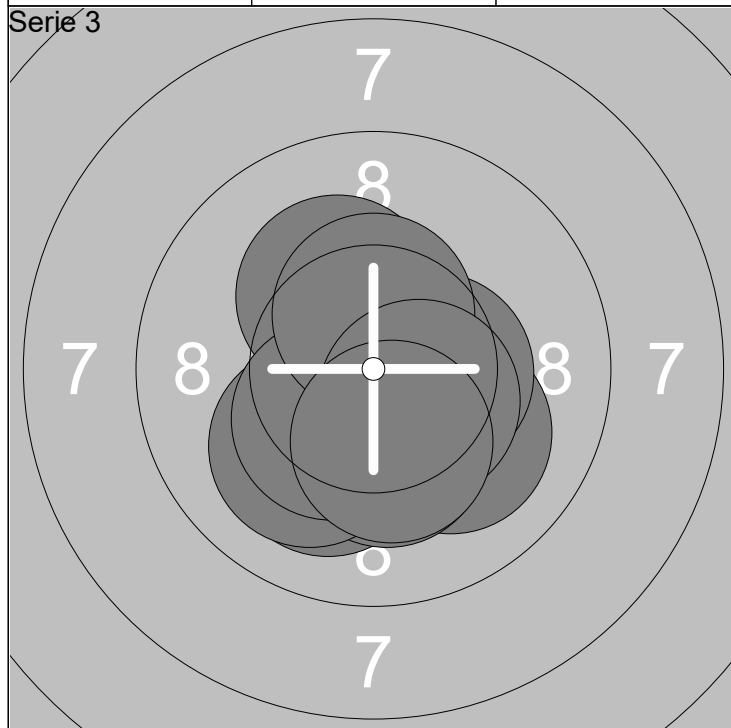

21: 10.1 ↙	26: 10.4x ↙	Serie	100
22: 10.1 ↙	27: 10.4x →		
23: 10.3x ↓	28: 10.4x ↑	Total	300
24: 10.2x ↗	29: 10.4x ↓		
25: 10.1 ↙	30: 10.3x ↓		

31: 10.4x ↓	36: 10.4x ↓	Serie	100
32: 10.6x ↙	37: 10.4x ↓		
33: 10.0 ↗	38: 10.4x ↑	Total	400
34: 10.2x ↑	39: 10.2x →		
35: 10.2x ↗	40: 10.7x →		

Skjutlag
4

Tavla
29

Björn Bjarnasson

Rottne Industri Cup 2018

Värnamo Skytteförening

Ösm

27.10.2018

Rottne Industri Cup 2018

Söraby SKF

Serie 1

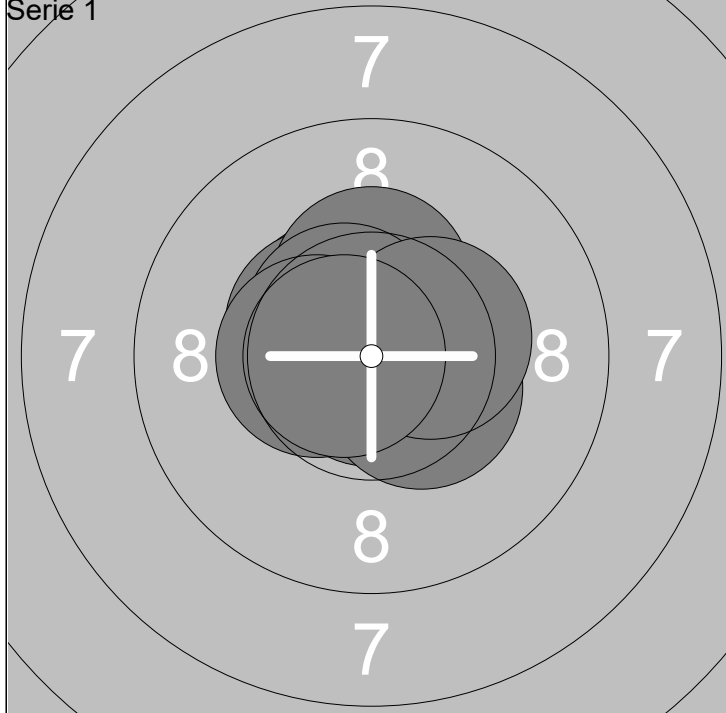

Serie 2

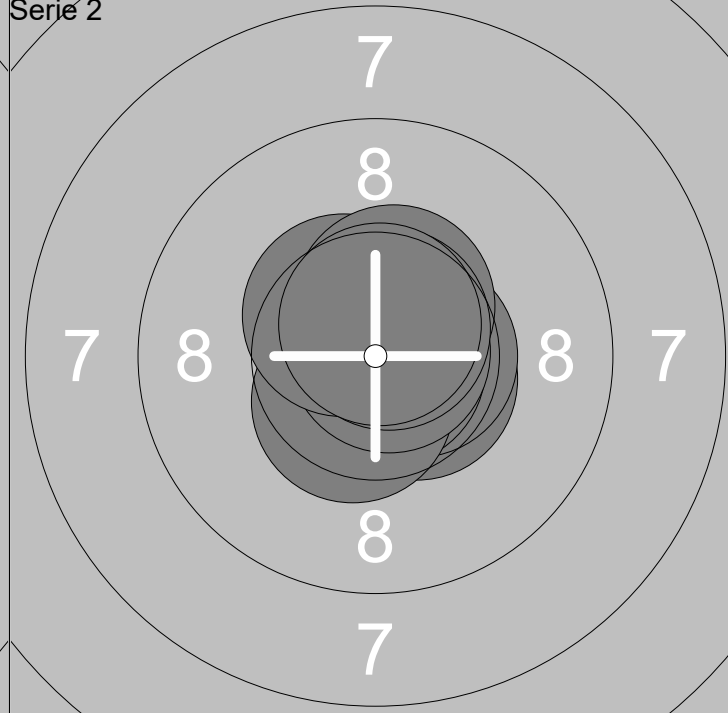

1: 10.5x ↖	6: 10.4x ↑
2: 10.9x ↓	7: 10.6x ↗
3: 10.5x ↖	8: 10.4x →
4: 10.5x ↑	9: 10.5x ←
5: 10.4x ↘	10: 10.7x ←

Serie	100
Total	100

11: 10.6x ↘	16: 10.8x →
12: 10.6x →	17: 10.5x ↗
13: 10.8x ↘	18: 10.5x ↑
14: 10.9x ↙	19: 10.7x ↗
15: 10.5x ↙	20: 10.7x ↑

Serie	100
Total	200

Serie 3

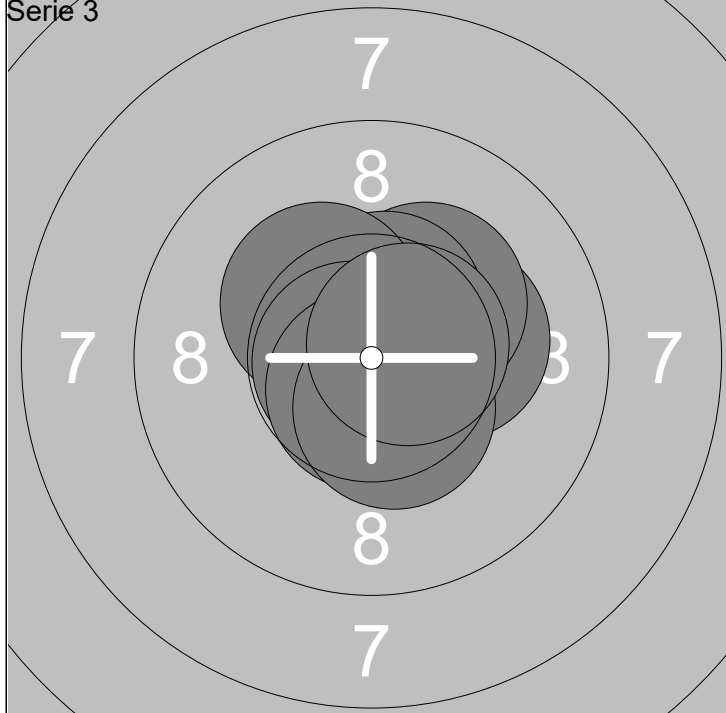

Serie 4

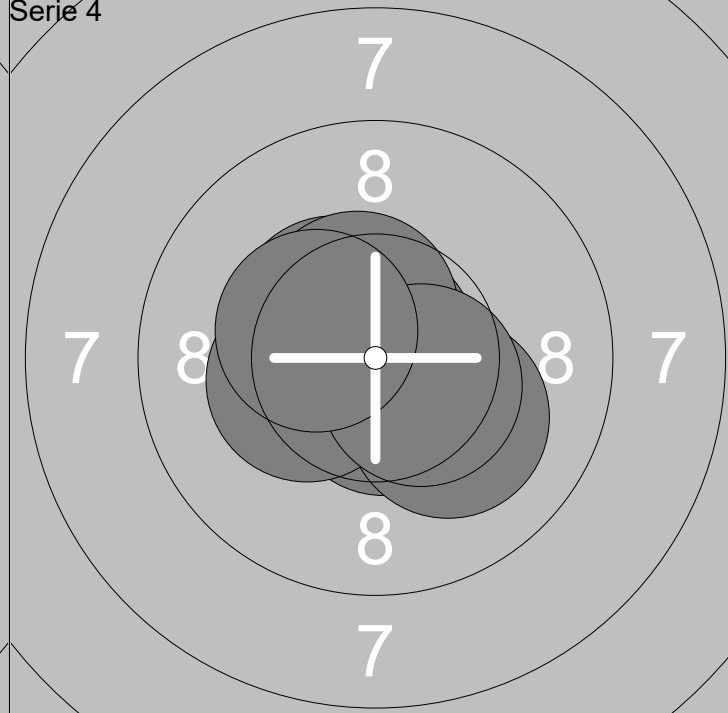

21: 10.2x →	26: 10.3x ↖
22: 10.5x ↗	27: 10.8x ←
23: 10.3x ↗	28: 10.7x ↓
24: 10.6x ↑	29: 10.5x ↘
25: 10.5x ↑	30: 10.6x →

Serie	100
Total	300

31: 10.4x ↖	36: 10.5x ↑
32: 10.8x ↑	37: 10.6x ←
33: 10.7x ↘	38: 10.3x ←
34: 10.6x ↘	39: 10.5x ↘
35: 10.1 ↘	40: 10.4x ↖

Serie	100
Total	400

Rottne Industri Cup 2018

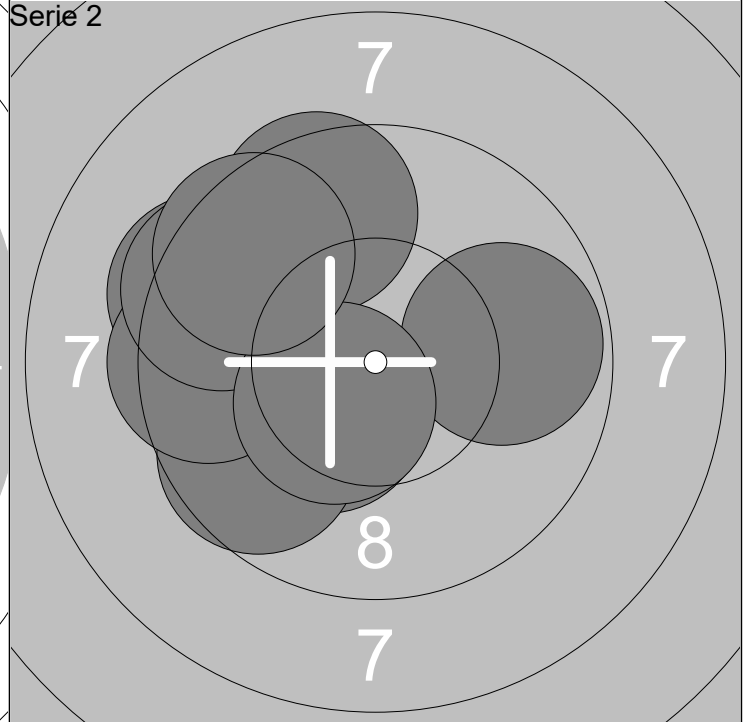
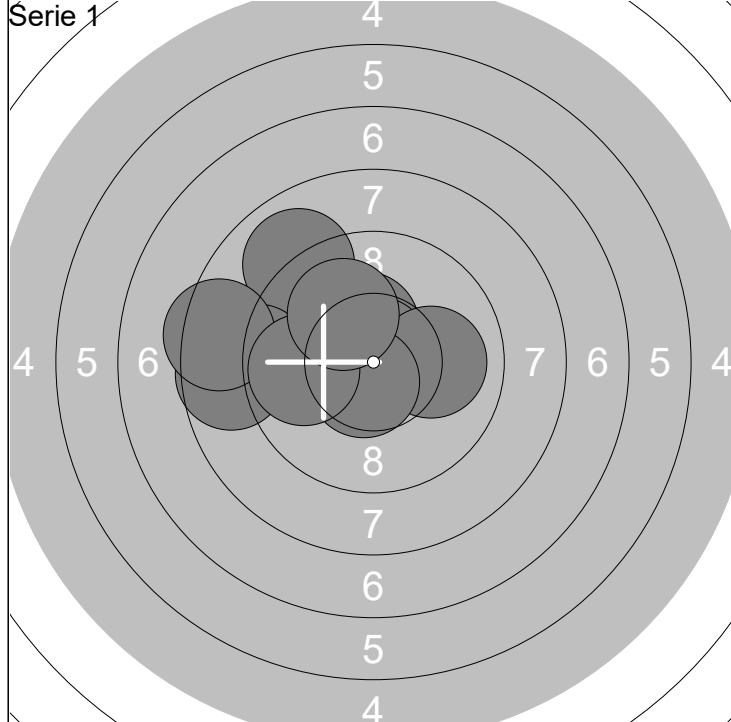

1: 10.4x ↗	6: 8.7 ←	Serie	93
2: 9.0 ↗	7: 8.4 ←		
3: 9.1 ←	8: 10.6x ↘	Total	93
4: 10.8x ↗	9: 9.8 ←		
5: 10.0 →	10: 10.0 ↗		

11: 9.8 ←	16: 9.6 ↙	Serie	92
12: 9.4 ←	17: 9.5 ←		
13: 9.5 ↗	18: 9.4 ↙	Total	185
14: 9.8 →	19: 10.4x ↙		
15: 10.3x ↙	20: 9.5 ↙		

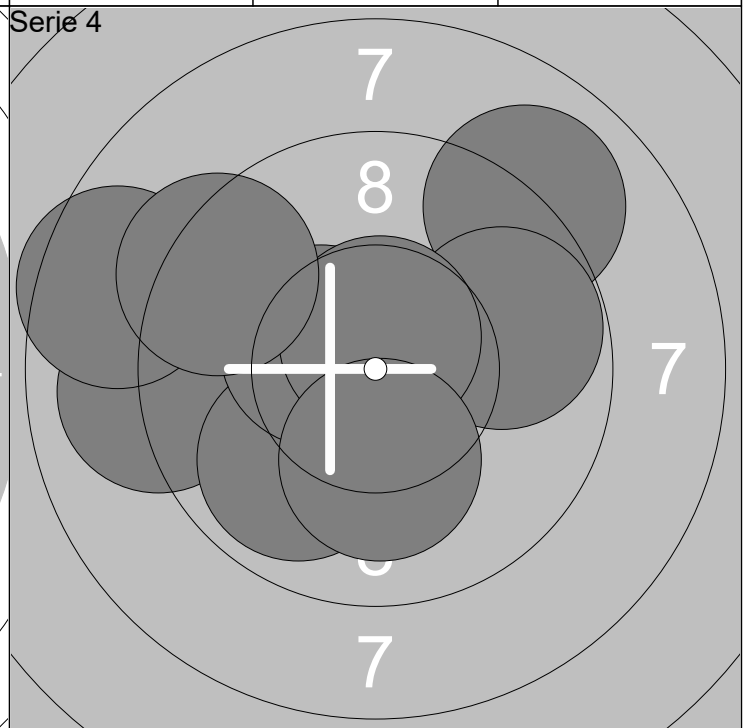
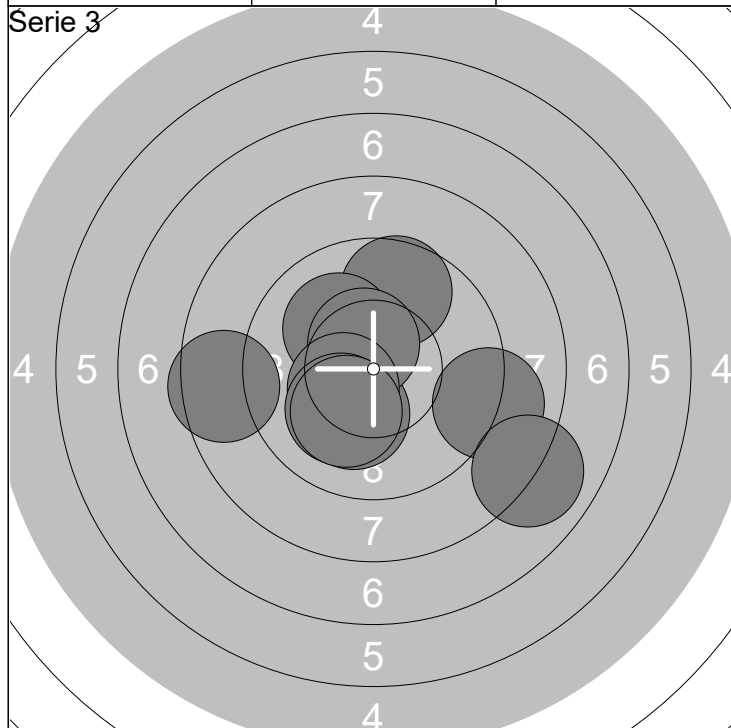

21: 9.7 ↗	26: 10.1 ↗	Serie	94
22: 10.2x ↘	27: 10.5x ↗		
23: 9.0 →	28: 10.4x ↙	Total	279
24: 8.0 ↘	29: 10.1 ↙		
25: 8.5 ←	30: 10.1 ↘		

31: 10.6x ↘	36: 9.8 →	Serie	93
32: 9.0 ↗	37: 10.4x ↙		
33: 9.0 ←	38: 10.7x ↗	Total	372
34: 9.9 ↘	39: 9.3 ↙		
35: 8.6 ←	40: 10.2x ↘		

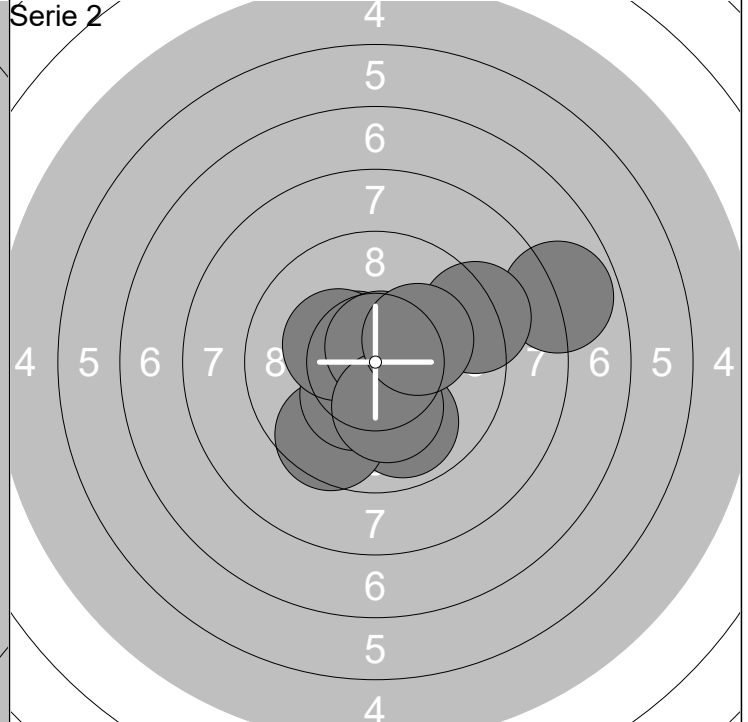
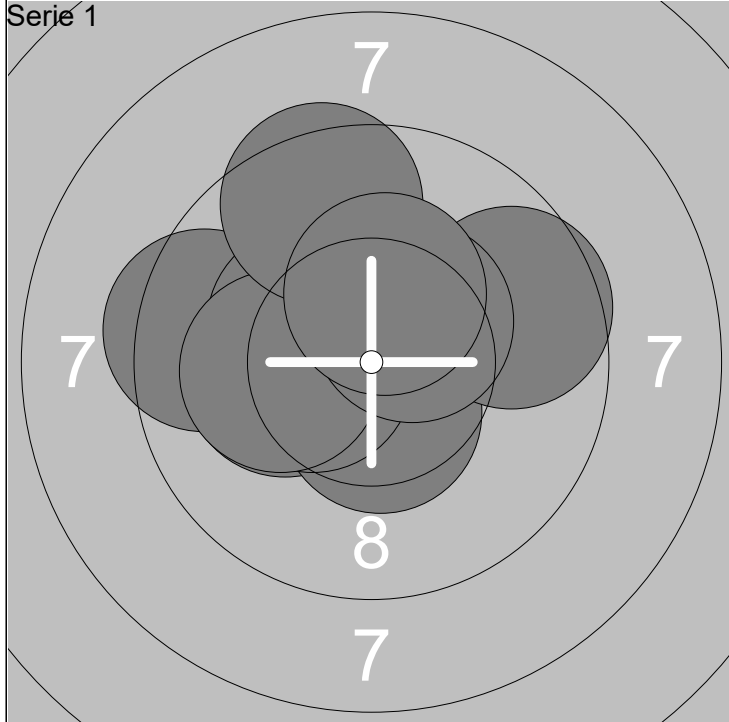

1: 9.4 ←	6: 10.4x ←	Serie	97
2: 10.2x ←	7: 10.1 ←		
3: 10.5x ↓	8: 9.5 ↑	Total	97
4: 9.6 →	9: 10.5x ↗		
5: 10.3x ↖	10: 10.3x ↑		

11: 7.8 →	16: 10.5x ↖	Serie	94
12: 9.9 ↓	17: 10.3x ↖		
13: 9.2 →	18: 10.7x ↑	Total	191
14: 9.6 ↓	19: 10.2x ↓		
15: 10.3x ↙	20: 10.2x ↗		

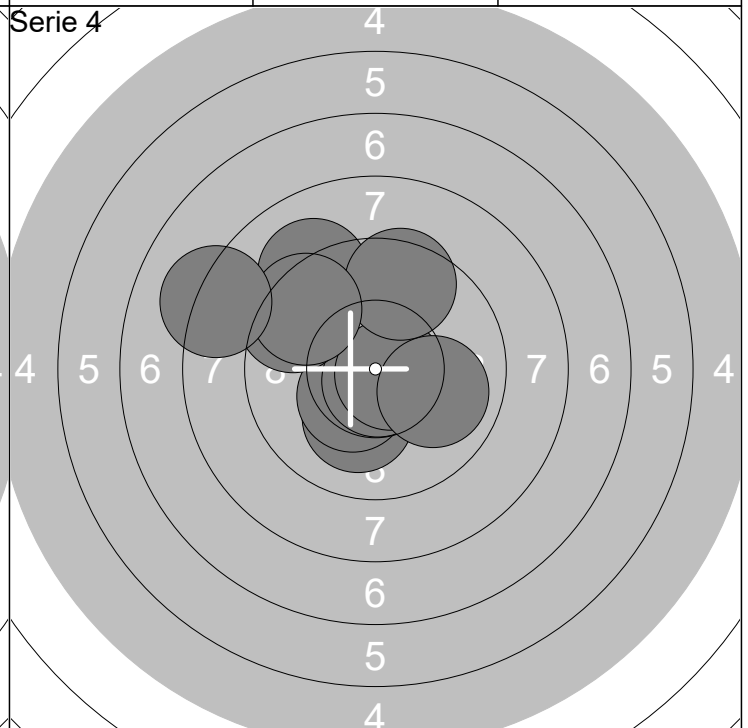
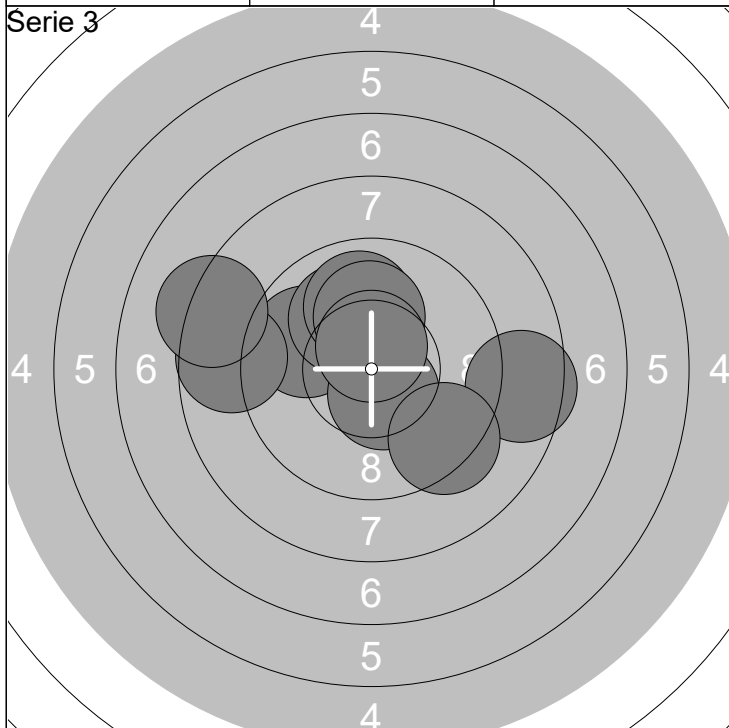

21: 9.8 ↖	26: 8.2 ←	Serie	91
22: 10.5x ↓	27: 9.9 ↑		
23: 8.5 →	28: 10.1 ↑	Total	282
24: 10.0 ↗	29: 10.6x ↑		
25: 8.7 ←	30: 9.3 ↘		

31: 10.1 ↓	36: 10.0 →	Serie	94
32: 10.4x ↙	37: 9.1 ↗		
33: 10.8x ↓	38: 9.6 ↑	Total	376
34: 9.4 ↖	39: 9.5 ↗		
35: 10.7x →	40: 8.2 ↖		

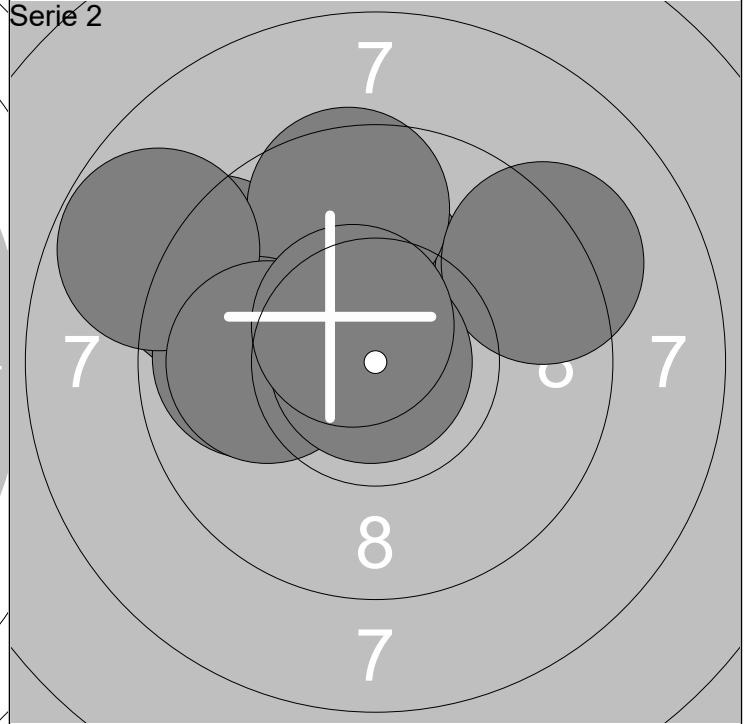
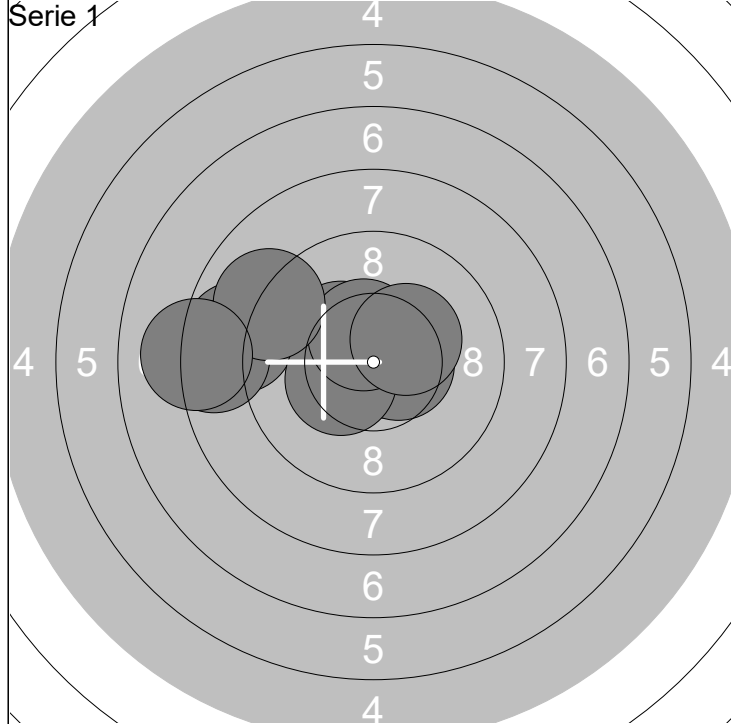

1: 10.8x →	6: 8.4 ←	Serie	93
2: 10.3x ↗	7: 10.5x ↗		
3: 10.5x →	8: 9.0 ↖	Total	93
4: 8.7 ←	9: 10.3x ↗		
5: 10.4x ↙	10: 8.1 ←		

11: 9.3 ↖	16: 8.8 ↖	Serie	93
12: 10.1 ↑	17: 10.0 ←		
13: 9.9 ↗	18: 9.2 ↗	Total	186
14: 9.6 ↑	19: 10.9x ←		
15: 9.9 ←	20: 10.6x ↗		

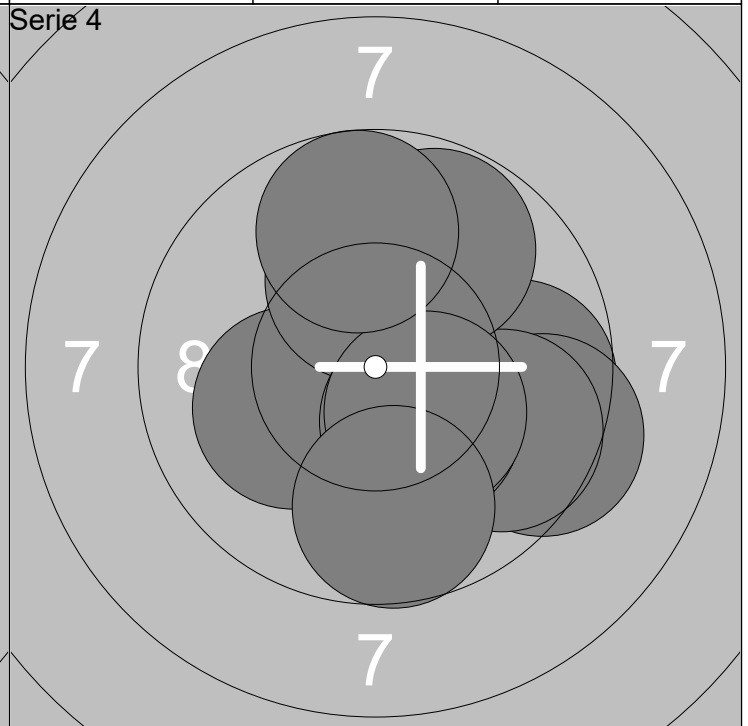
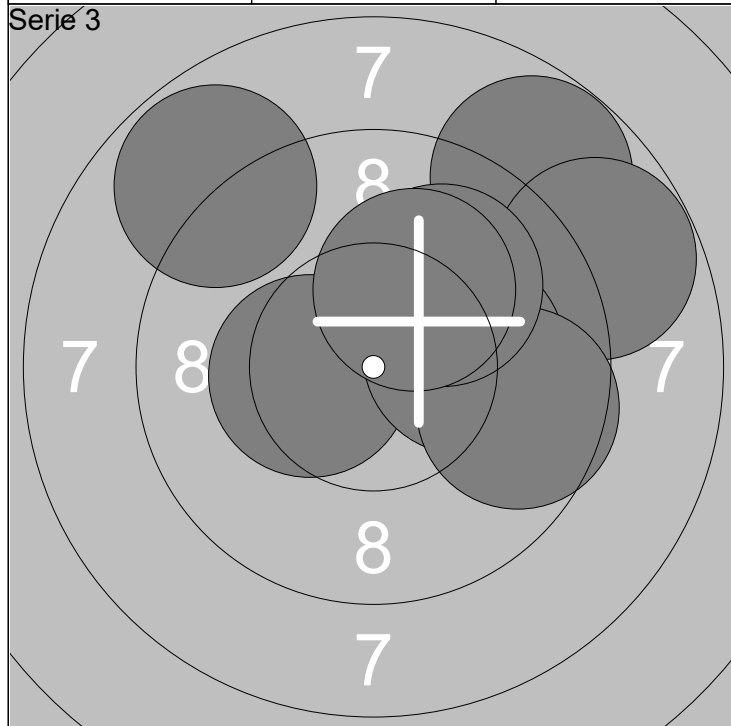

21: 8.8 ↗	26: 8.8 ↖	Serie	92
22: 10.3x ↗	27: 10.1 →		
23: 10.4x ←	28: 9.6 →	Total	278
24: 9.9 →	29: 10.0 ↗		
25: 8.8 ↗	30: 10.2x ↗		

31: 9.7 →	36: 10.3x ↘	Serie	94
32: 9.4 →	37: 9.8 ↗		
33: 10.1 ↙	38: 10.4x ↘	Total	372
34: 9.7 ↘	39: 9.7 ↑		
35: 10.2x ↑	40: 9.7 ↓		

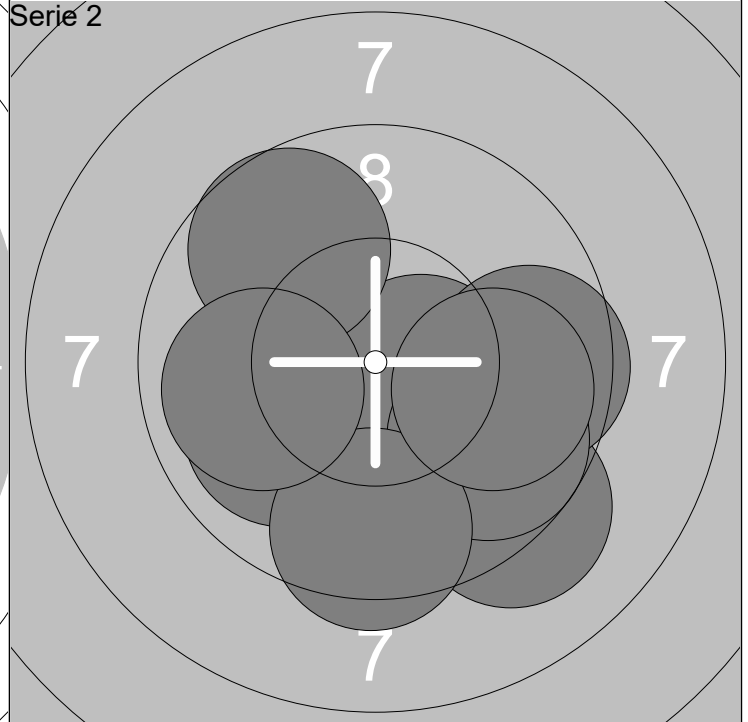
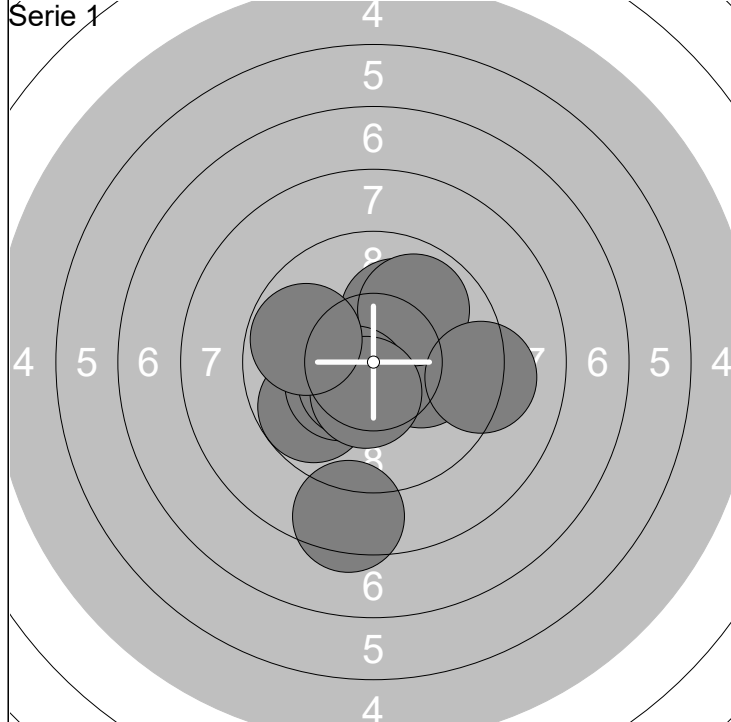

1: 8.4 ↓	6: 9.8 ↙	Serie	94
2: 10.1 ↗	7: 10.3x ↙		
3: 10.2x →	8: 10.5x ↙	Total	94
4: 9.9 ↗	9: 10.5x ↓		
5: 9.2 →	10: 9.8 ↖		

11: 9.2 ↓	16: 9.6 →	Serie	93
12: 10.0 ↙	17: 9.7 ↘		
13: 10.8x ↙	18: 9.5 ↓	Total	187
14: 10.5x →	19: 9.9 ↖		
15: 9.7 ↗	20: 9.9 →		

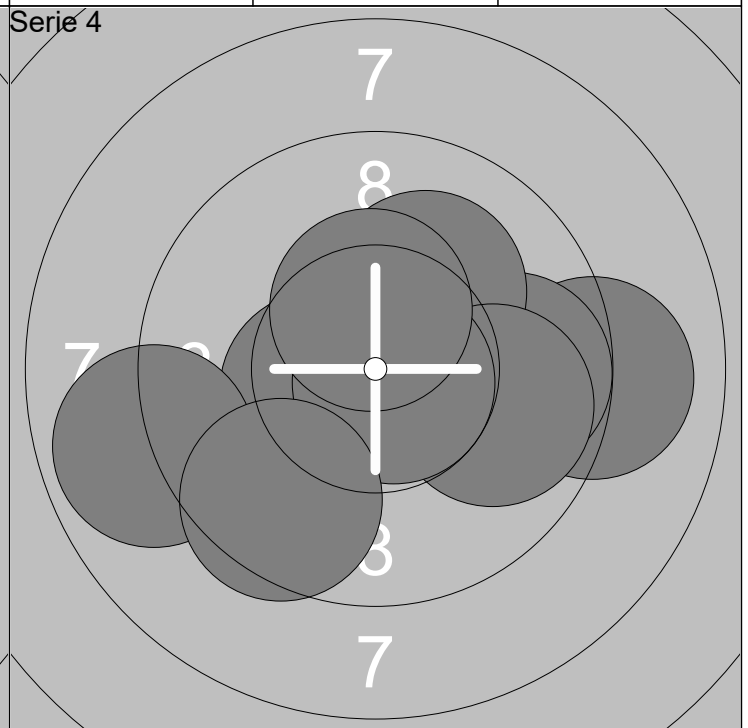
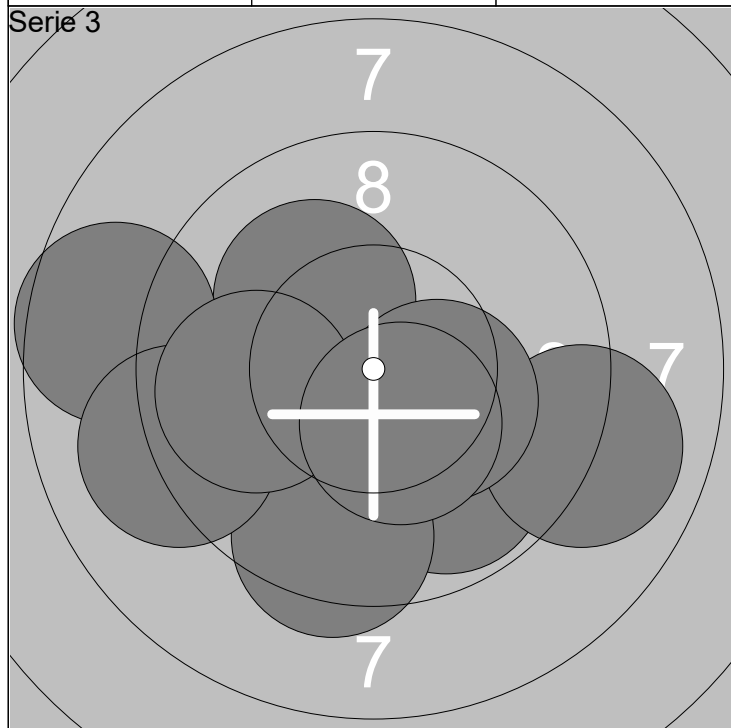

21: 9.8 ↓	26: 9.4 ↓	Serie	92
22: 9.0 →	27: 8.6 ↖		
23: 9.9 ↖	28: 9.1 ↖	Total	279
24: 10.2x ↗	29: 9.9 ↖		
25: 10.3x →	30: 10.4x ↓		

31: 9.0 →	36: 9.9 →	Serie	94
32: 10.3x ↗	37: 10.8x ↘		
33: 9.8 →	38: 8.9 ↖	Total	373
34: 10.4x ↖	39: 9.5 ↘		
35: 10.1 ↗	40: 10.4x ↗		

Skjutlag

Tavla

5

7

Jennifer Nordvall

Rottne Industri Cup 2018

Gullabo Skytteförening

L15s

27.10.2018

Rottne Industri Cup 2018

Söraby SKF

Serie 1

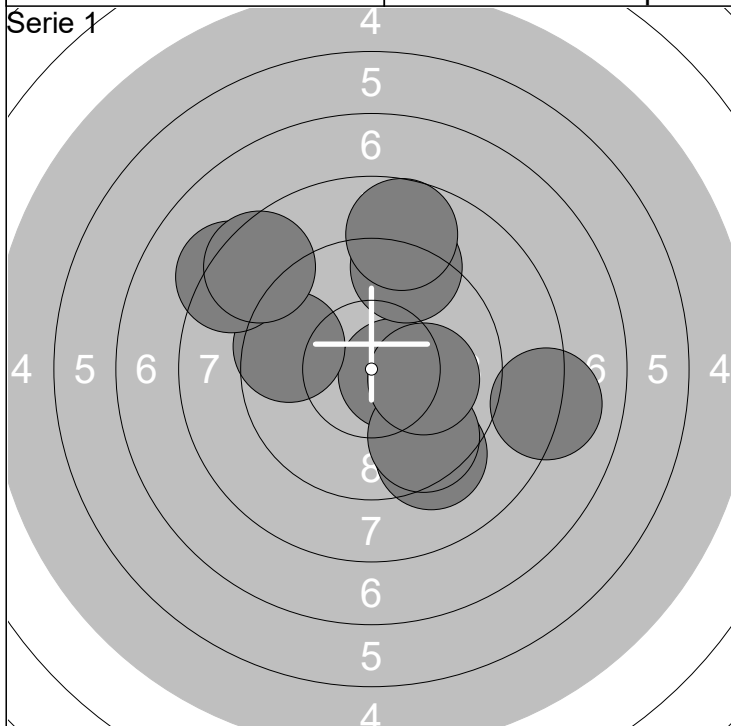

Serie 2

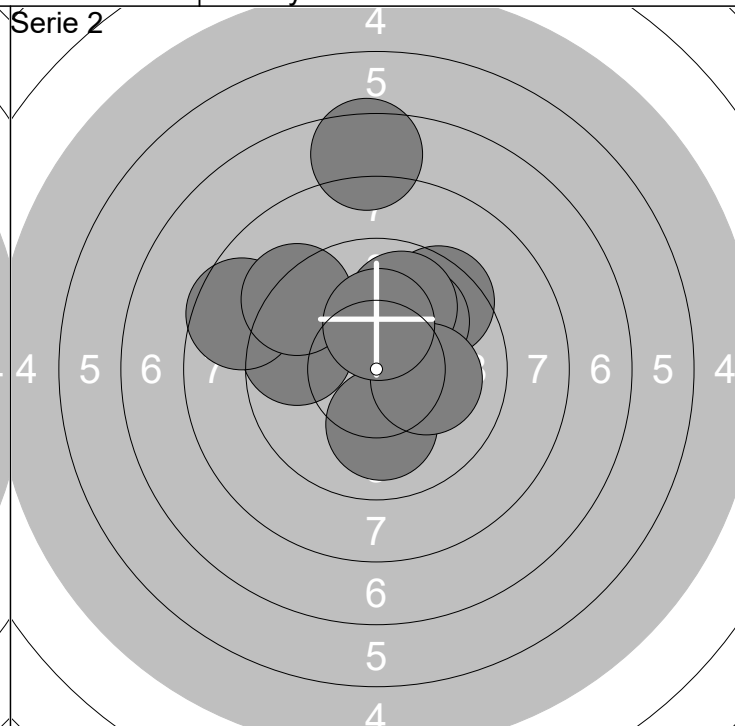

1:	8.1	→	6:	9.3	↘
2:	10.6x	→	7:	9.6	↘
3:	9.6	←	8:	8.3	↗
4:	9.2	↑	9:	10.1	→
5:	8.7	↑	10:	8.5	↗

Serie 88

Total 88

11:	9.5	↗	16:	9.9	↗
12:	10.0	↗	17:	9.2	↖
13:	9.6	←	18:	10.1	↓
14:	7.5	↑	19:	10.1	→
15:	8.6	←	20:	10.2x	↑

Serie 91

Total 179

Serie 3

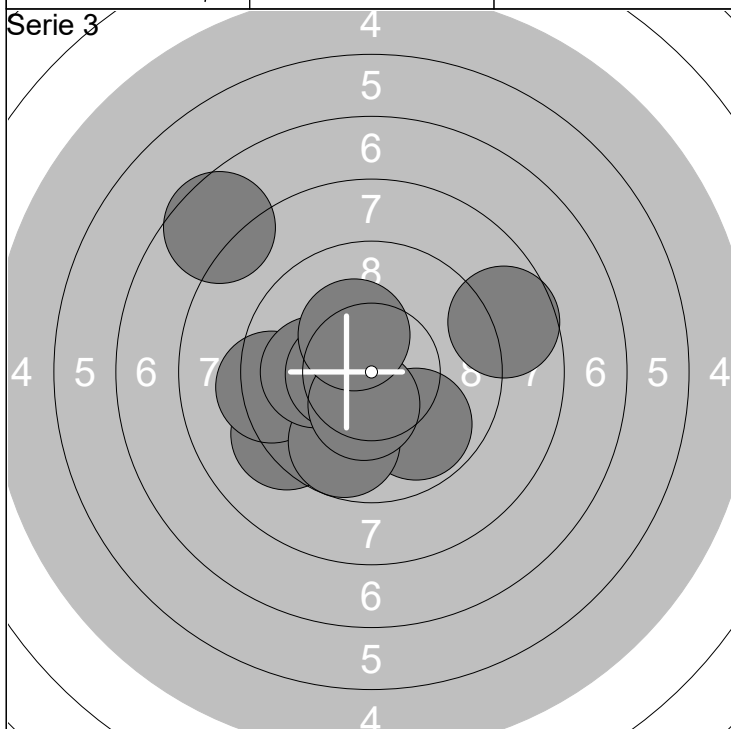

Serie 4

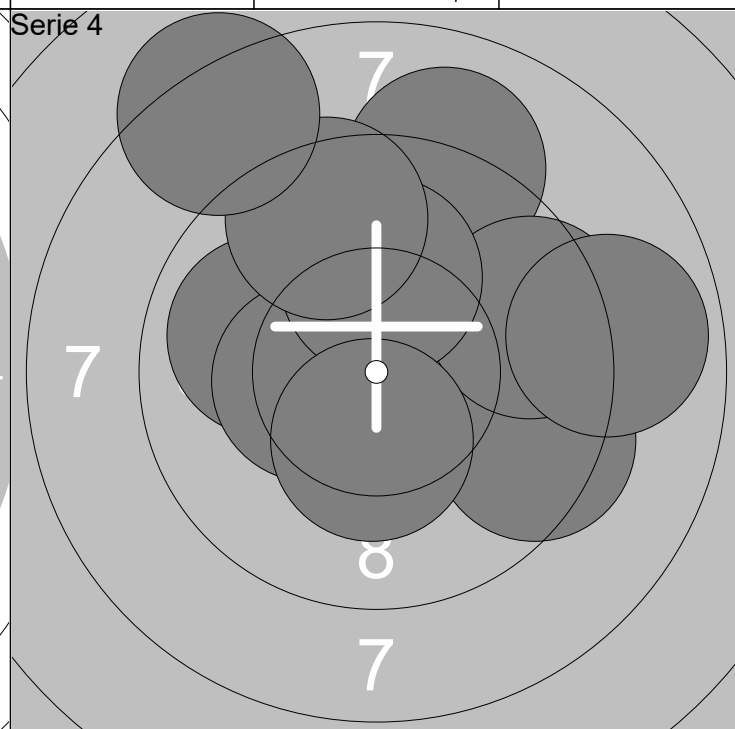

21:	9.3	↖	26:	9.7	↓
22:	9.3	←	27:	10.1	←
23:	9.8	↘	28:	10.5x	←
24:	8.7	→	29:	10.4x	↓
25:	7.6	↗	30:	10.3x	↗

Serie 91

Total 270

31:	9.4	→	36:	10.1	↑
32:	10.0	←	37:	10.3x	↓
33:	10.4x	←	38:	8.9	→
34:	9.1	↑	39:	9.5	↑
35:	9.5	→	40:	8.3	↖

Serie 92

Total 362

Rottne Industri Cup 2018

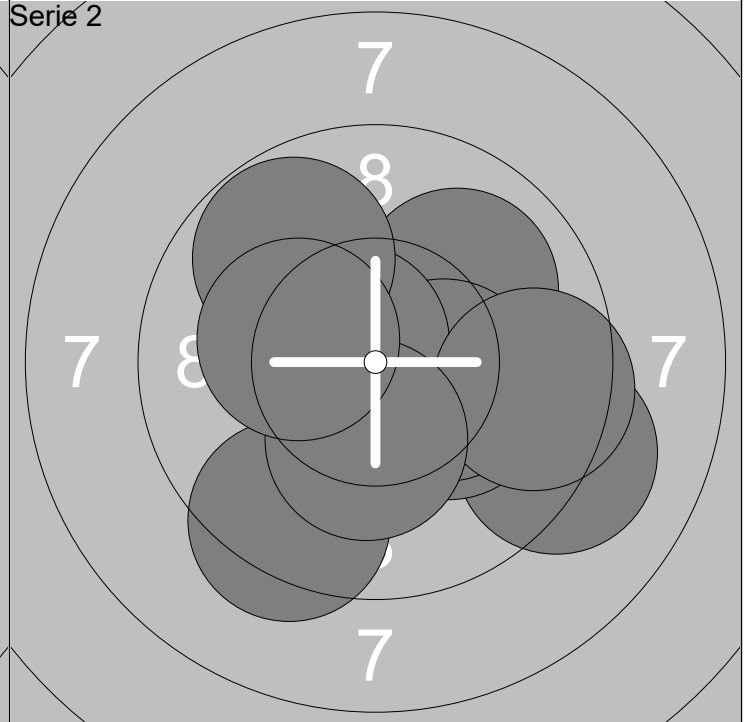
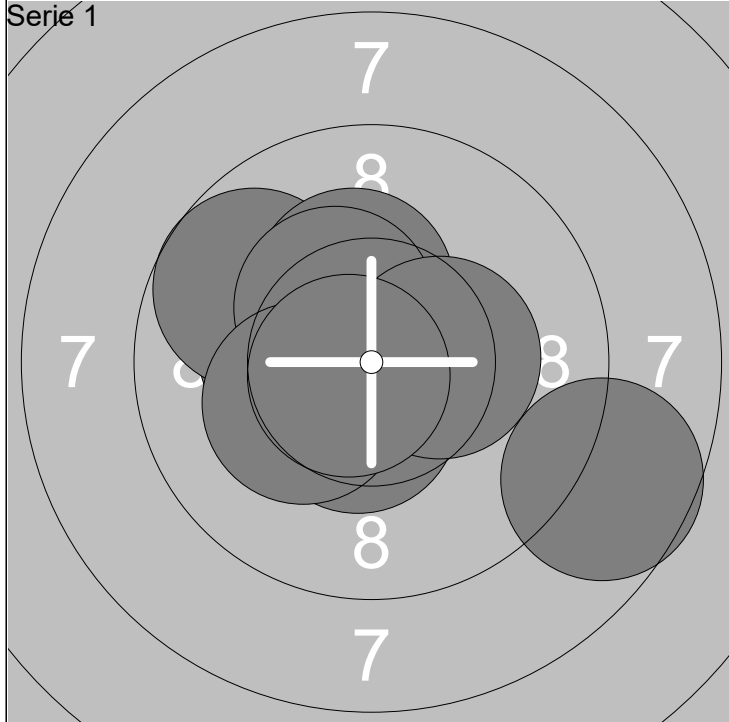

1: 10.6x ↗	6: 10.3x ↑	Serie	97
2: 10.3x ←	7: 10.4x ↗		
3: 8.7 ↘	8: 10.3x ←	Total	97
4: 9.7 ↗	9: 10.4x →		
5: 10.5x ↓	10: 10.7x ←		

11: 10.0 ↗	16: 10.7x ↗	Serie	96
12: 9.2 →	17: 9.8 ↗		
13: 10.2x →	18: 9.5 →	Total	193
14: 10.3x →	19: 10.2x ↓		
15: 9.4 ↓	20: 10.2x ←		

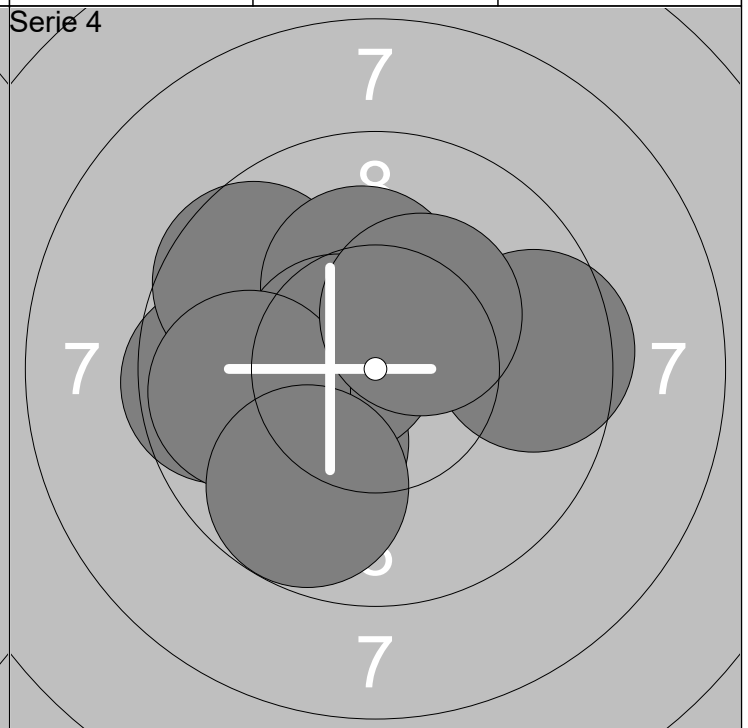
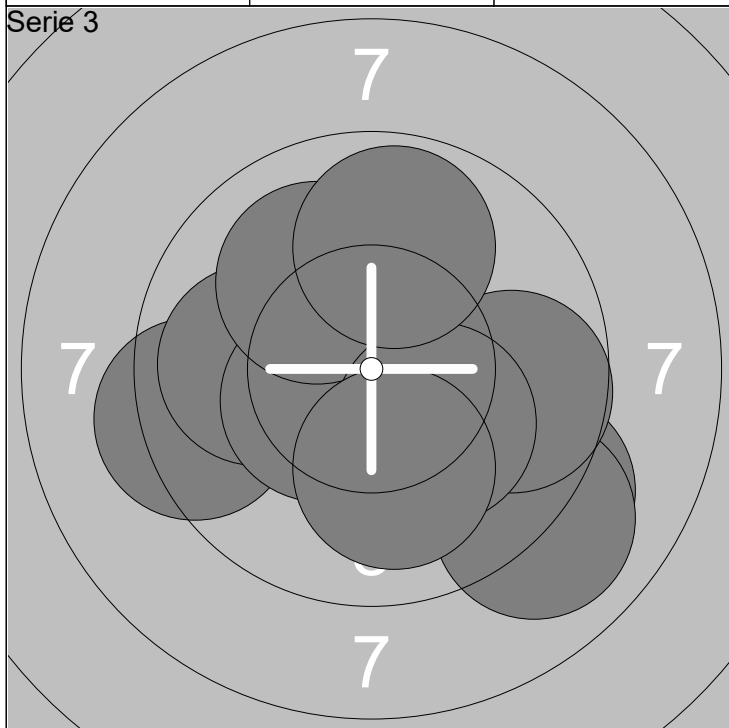

21: 9.3 ←	26: 9.0 ↘	Serie	94
22: 9.9 ←	27: 9.7 →		
23: 10.4x ←	28: 10.2x ↘	Total	287
24: 10.1 ↗	29: 10.1 ↓		
25: 9.1 ↘	30: 9.9 ↑		

31: 10.0 ←	36: 10.6x ←	Serie	95
32: 9.6 ←	37: 9.8 ←		
33: 9.6 ↗	38: 9.8 ↓	Total	382
34: 10.2x ↑	39: 9.5 →		
35: 10.1 ↘	40: 10.3x ↗		

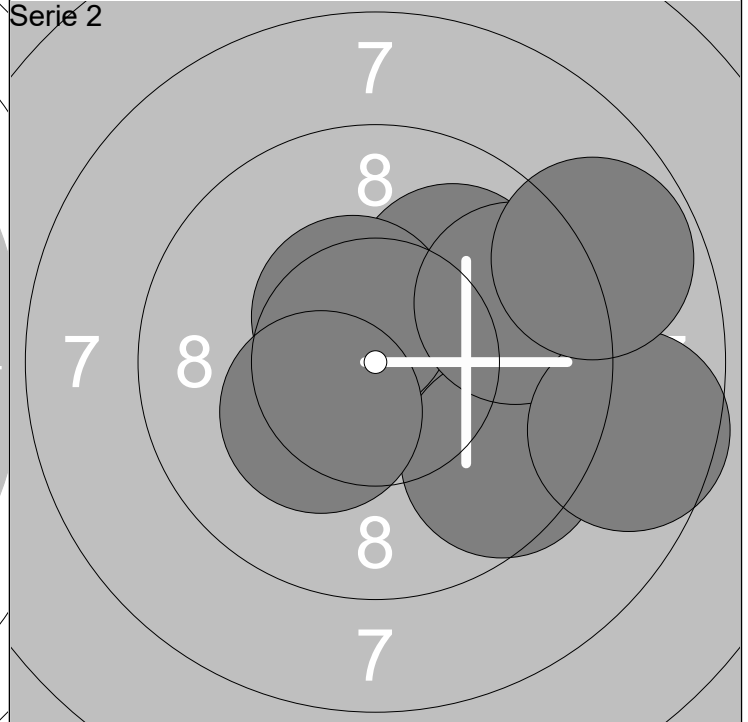
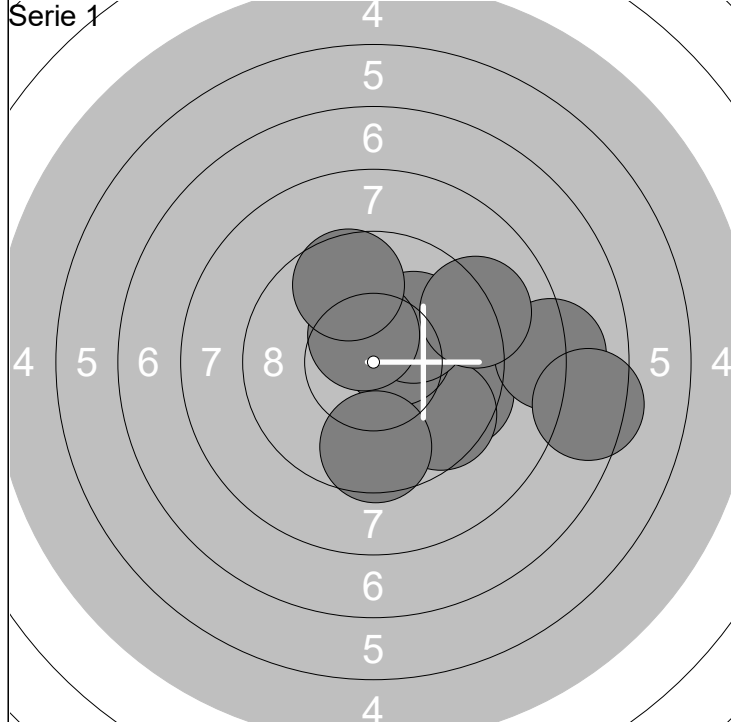

1: 9.5 →	6: 10.1 ↗	Serie	90
2: 9.6 ↘	7: 9.1 ↗		
3: 10.5x ↗	8: 7.4 →	Total	90
4: 9.6 ↓	9: 10.5x ↗		
5: 8.1 →	10: 9.7 ↗		

11: 10.4x →	16: 9.6 ↘	Serie	93
12: 10.0 ↗	17: 10.3x ↘		
13: 9.8 →	18: 9.6 ↗	Total	183
14: 10.7x →	19: 8.6 →		
15: 10.5x ↗	20: 8.8 ↗		

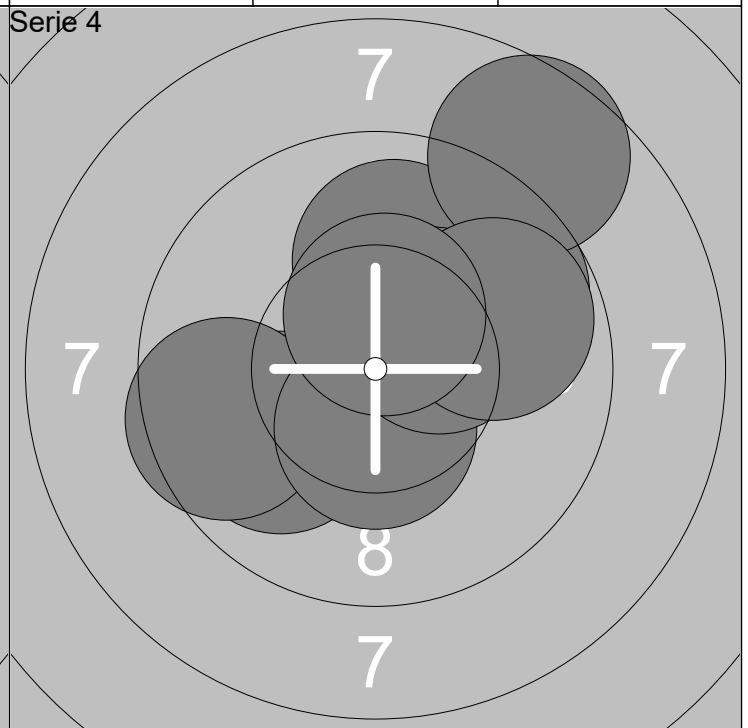
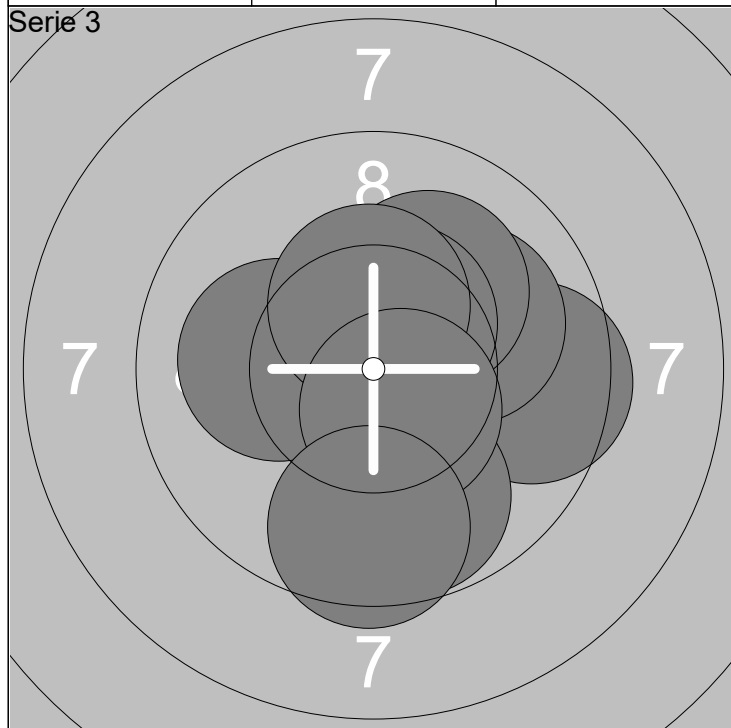

21: 10.7x ↗	26: 10.1 ←	Serie	97
22: 9.5 →	27: 9.8 ↓		
23: 10.1 ↗	28: 10.4x ↗	Total	280
24: 10.1 ↗	29: 10.5x ↘		
25: 10.5x ↗	30: 9.5 ↓		

31: 9.9 ↘	36: 8.6 ↗	Serie	94
32: 9.5 ←	37: 10.4x ↓		
33: 9.7 ↗	38: 10.3x ↗	Total	374
34: 10.0 ↗	39: 9.8 ↗		
35: 10.4x ↗	40: 10.5x ↗		

Serie 1

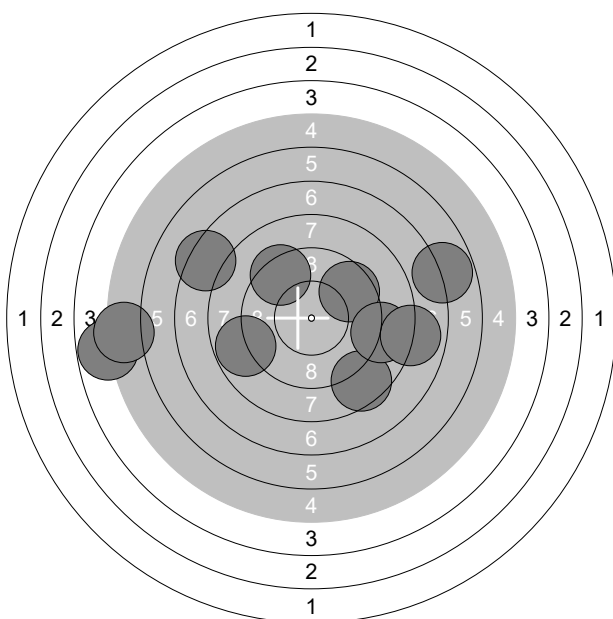

1:	4.8	←	6:	9.6	↗	Serie	71
2:	8.8	↙	7:	7.4	↖		
3:	6.8	→	8:	8.8	→	Total	71
4:	8.6	↘	9:	7.9	→		
5:	9.4	↗	10:	5.3	←		

Serie 2

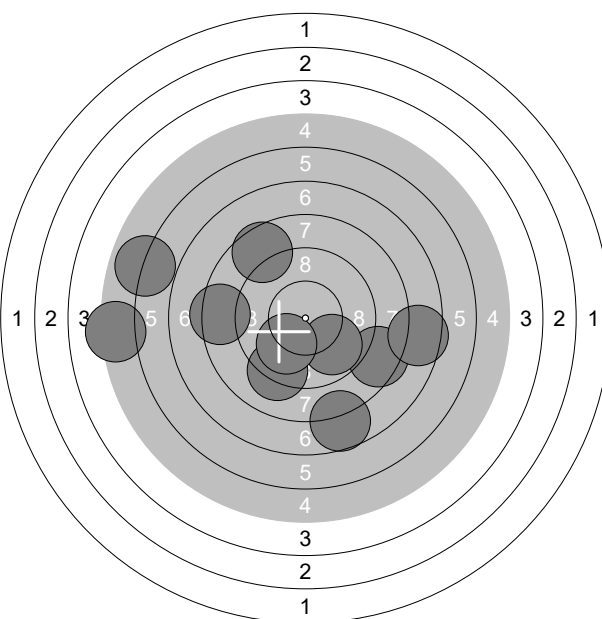

11:	8.6	↗	16:	7.6	→	Serie	76
12:	8.5	→	17:	5.9	↖		
13:	7.7	↘	18:	9.8	↘	Total	147
14:	5.3	←	19:	9.2	↘		
15:	8.4	←	20:	10.0	↘		

Serie 3

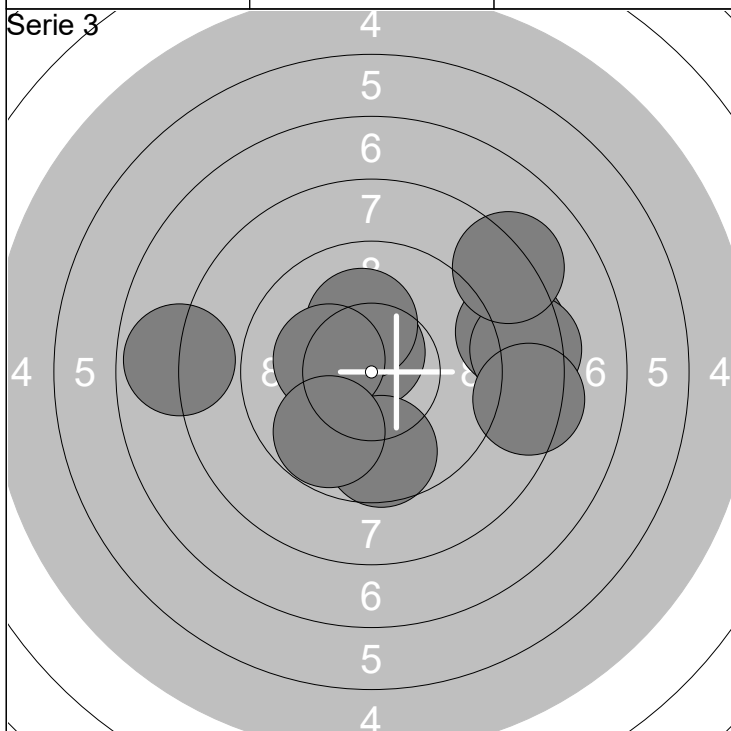

21:	8.6	→	26:	8.4	→	Serie	87
22:	7.9	←	27:	10.2x	↑		
23:	8.4	→	28:	9.7	↘	Total	234
24:	8.2	↗	29:	10.3x	↖		
25:	10.6x	↑	30:	9.8	↘		

Serie 4

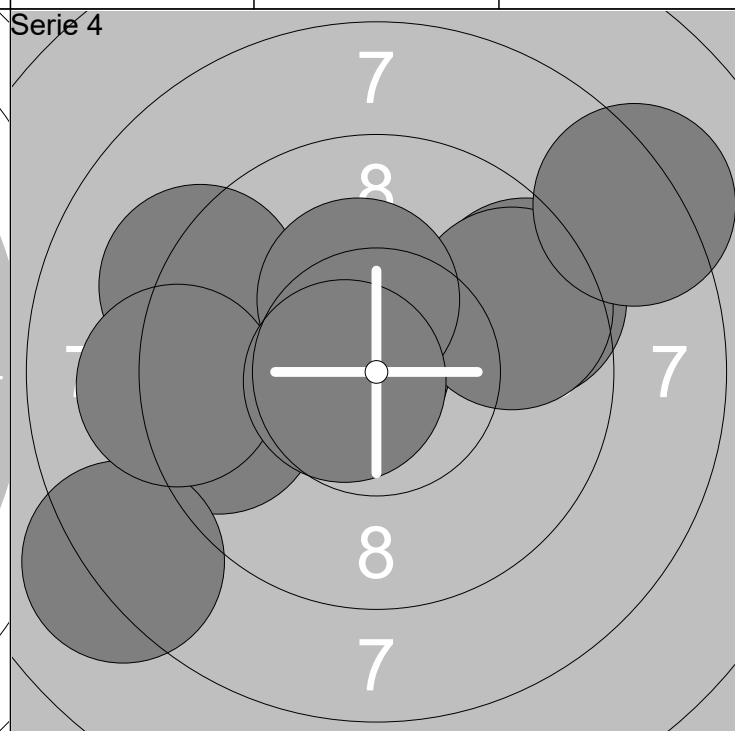

31:	10.7x	↖	36:	9.2	↖	Serie	91
32:	9.5	←	37:	9.2	←		
33:	9.5	↗	38:	8.2	↗	Total	325
34:	9.6	↗	39:	10.3x	↑		
35:	8.1	↖	40:	10.7x	←		

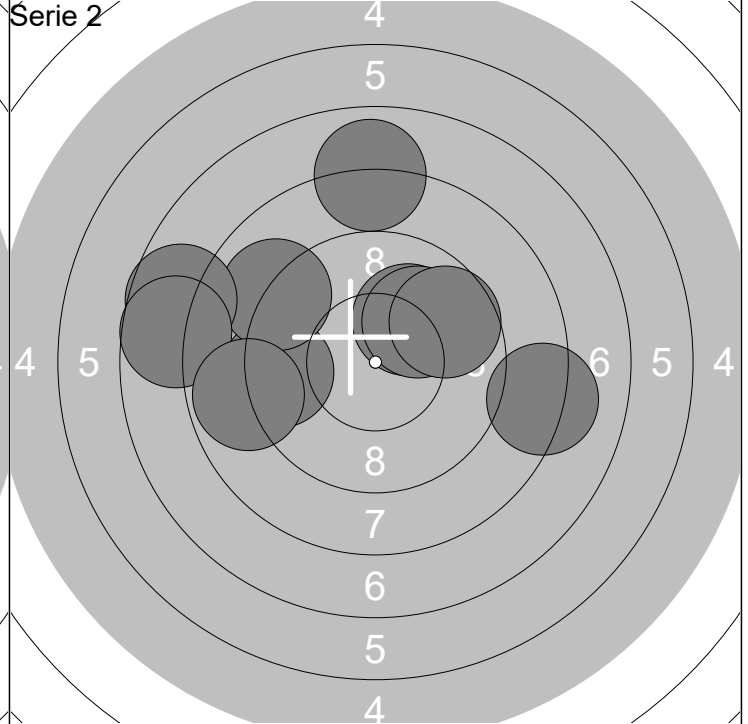
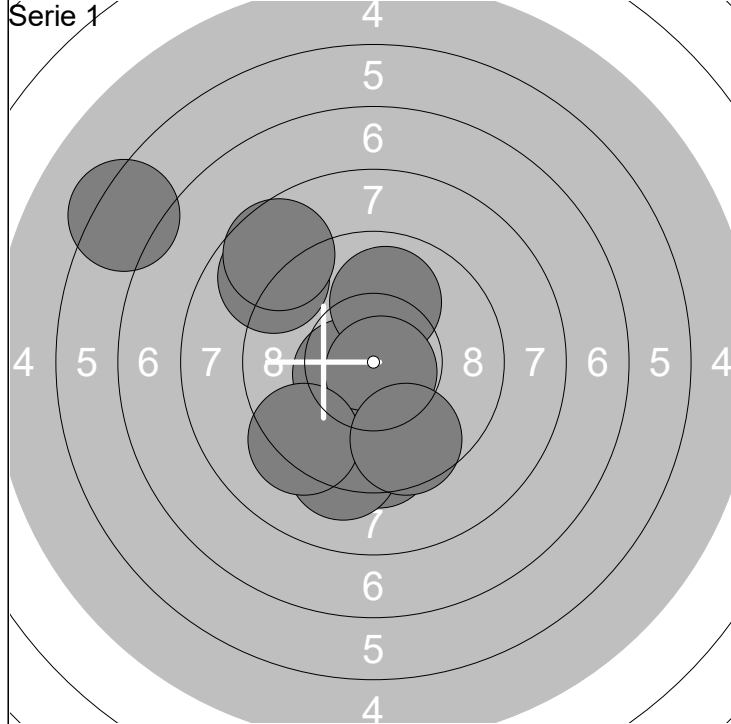

1: 10.5x ↙	6: 9.3 ↘		Serie	88	11: 9.4 ←	16: 10.0 ↗		Serie	84
2: 10.0 ↑	7: 8.8 ↗				12: 9.0 ↖	17: 9.6 ↗			
3: 9.5 ↓	8: 6.3 ↗	Total	88	13: 7.9 ↑	18: 7.7 ←	Total	172		
4: 10.7x ↘	9: 9.6 ↘			14: 7.7 ←	19: 8.2 →				
5: 9.2 ↓	10: 8.7 ↗			15: 10.1 ↗	20: 8.9 ←				

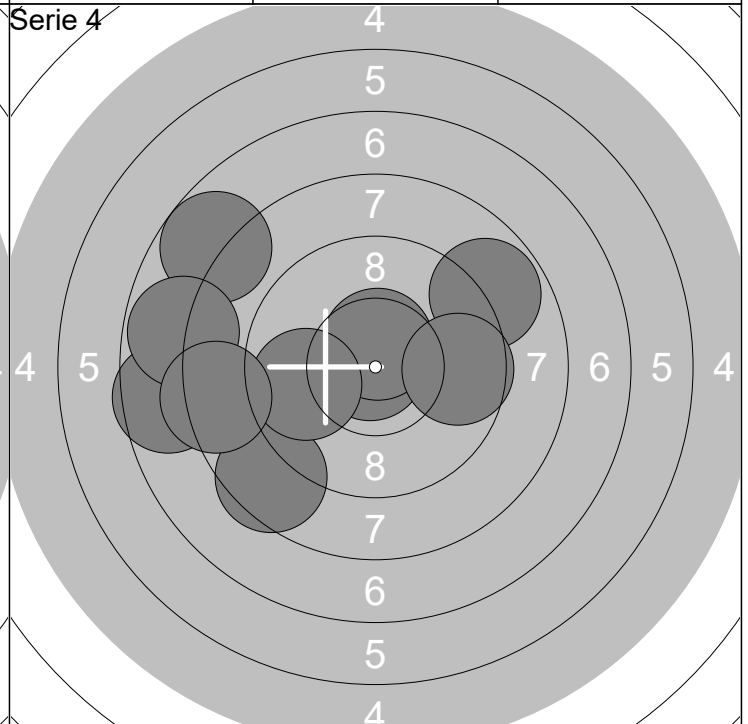
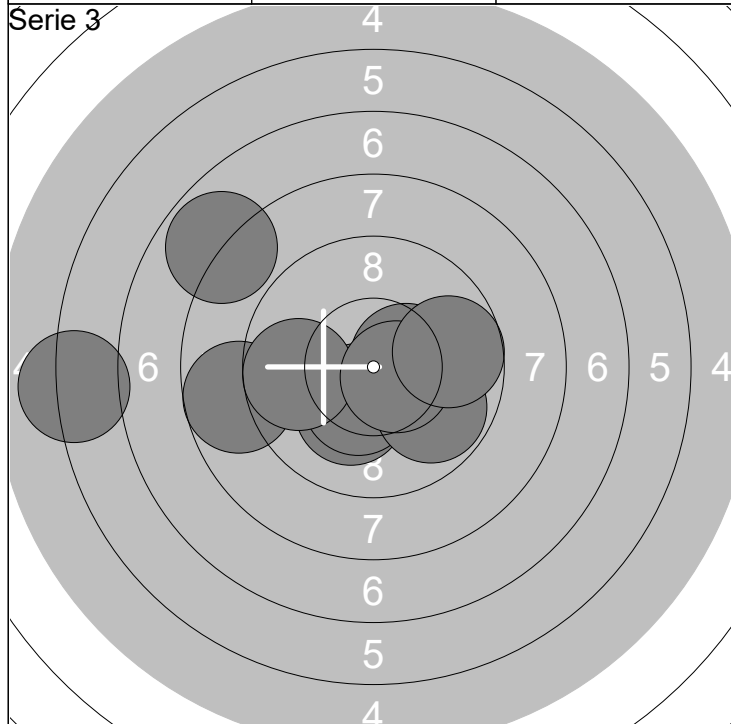

21: 8.7 ←	26: 7.8 ↗		Serie	88	31: 8.5 ↘	36: 7.8 ←		Serie	83
22: 10.2x ↘	27: 9.8 ↘				32: 7.7 ↖	37: 9.8 ←			
23: 6.1 ←	28: 9.7 ←	Total	260	33: 10.9x ↖	38: 8.8 ↗	Total	343		
24: 10.4x →	29: 10.5x →			34: 10.6x ↑	39: 9.6 →				
25: 10.4x ↘	30: 9.7 →			35: 7.6 ←	40: 8.3 ←				

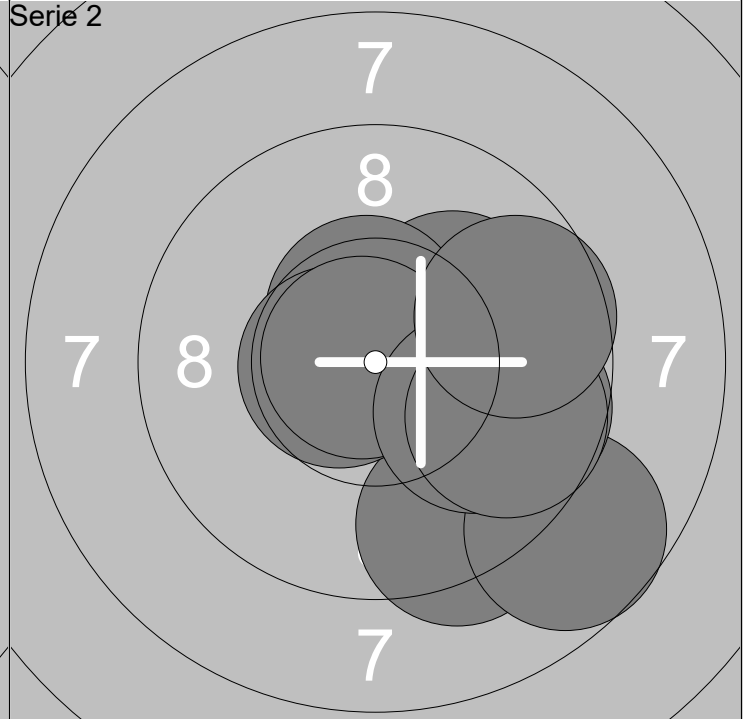
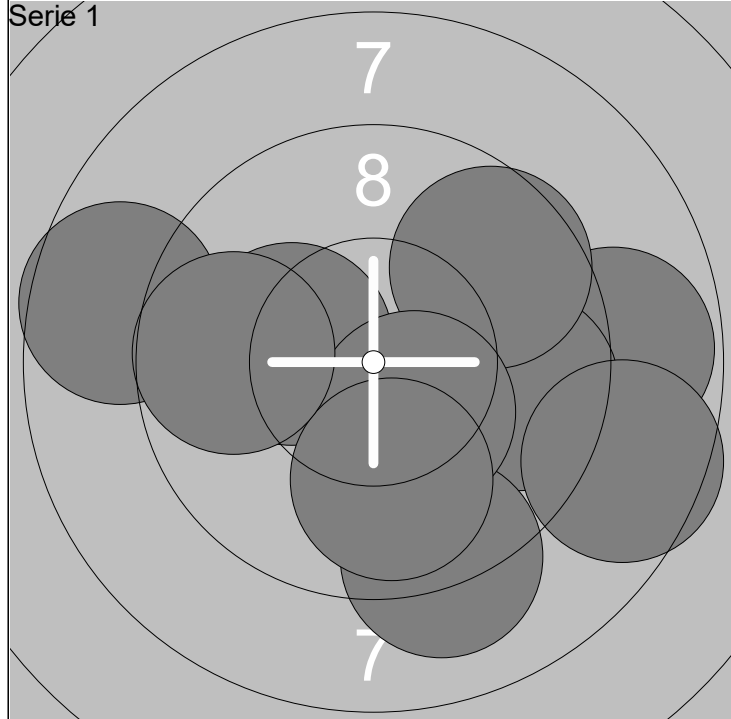

1: 8.8 →	6: 9.1 ↓	Serie	89
2: 8.7 ←	7: 10.4x ↓		
3: 10.2x ←	8: 9.9 ↓	Total	89
4: 9.6 →	9: 8.6 ↓		
5: 9.6 ↗	10: 9.7 ←		

11: 10.1 ↗	16: 10.6x ←	Serie	94
12: 9.4 ↓	17: 10.8x ←		
13: 8.7 ↓	18: 10.0 ↓	Total	183
14: 10.5x ↑	19: 9.7 ↓		
15: 9.7 →	20: 9.6 →		

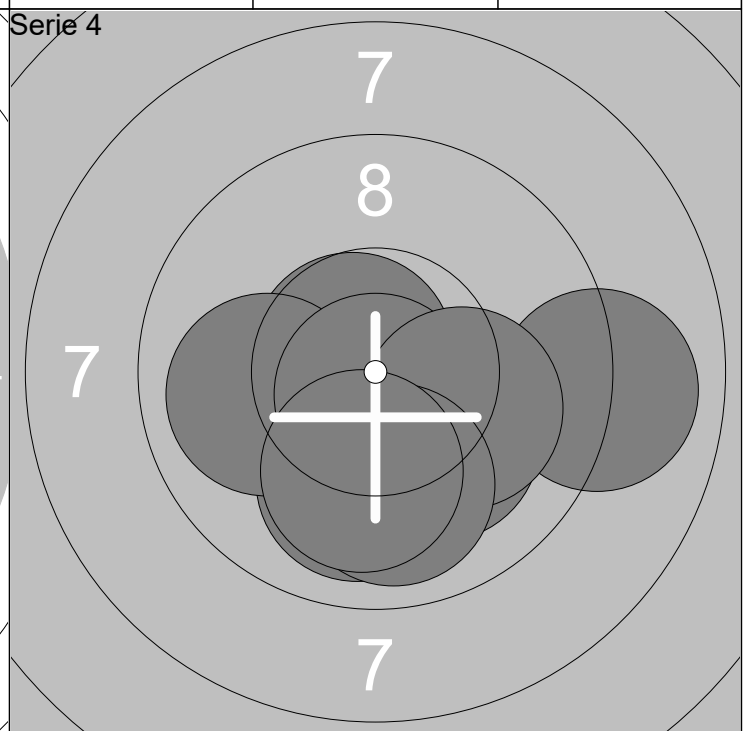
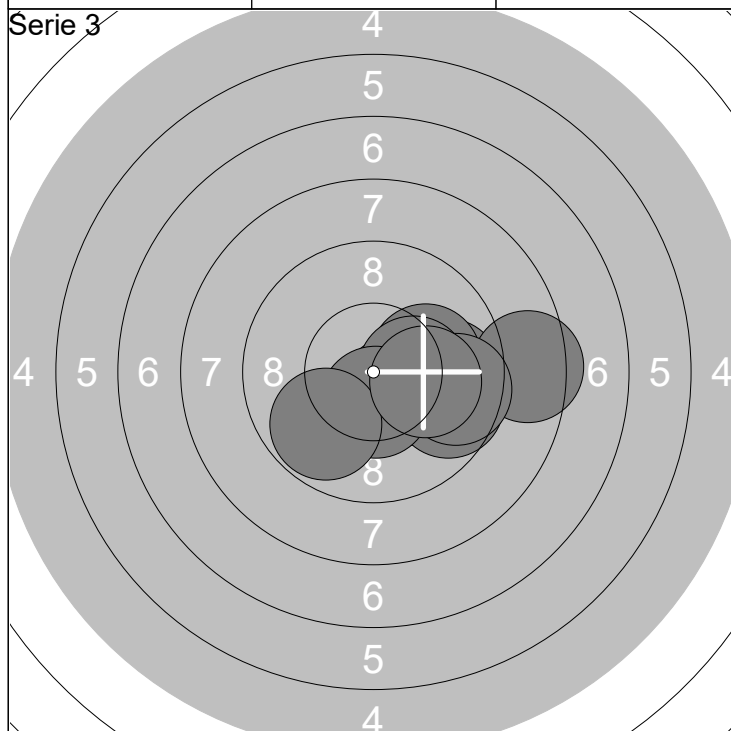

21: 9.8 →	26: 9.7 →	Serie	94
22: 10.1 →	27: 9.6 →		
23: 10.5x ↓	28: 10.5x ↓	Total	277
24: 8.4 →	29: 9.8 ↓		
25: 10.3x →	30: 10.1 →		

31: 10.3x ↓	36: 10.0 ←	Serie	98
32: 10.0 ↓	37: 10.7x ↓		
33: 10.7x ↗	38: 10.1 →	Total	375
34: 10.1 ↓	39: 9.9 ↓		
35: 9.0 →	40: 10.1 ↓		

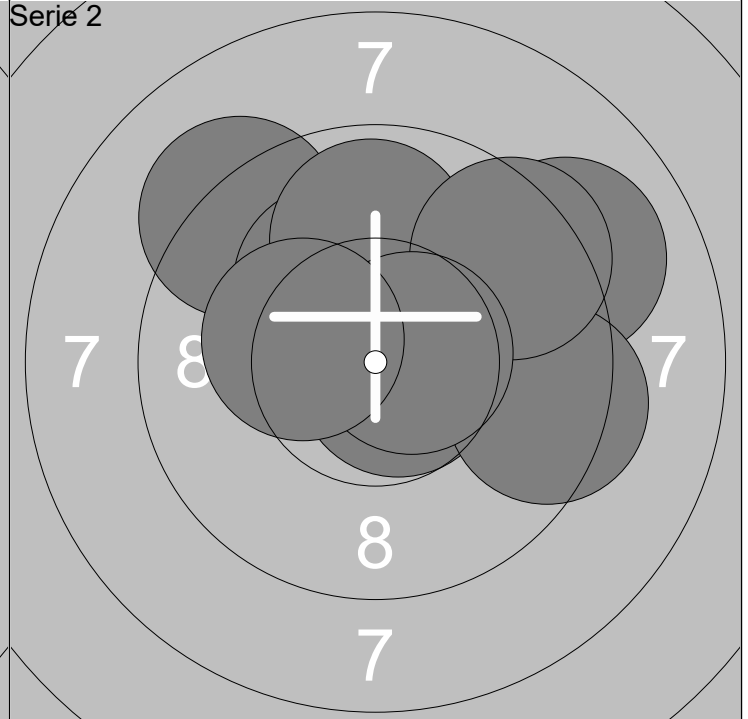
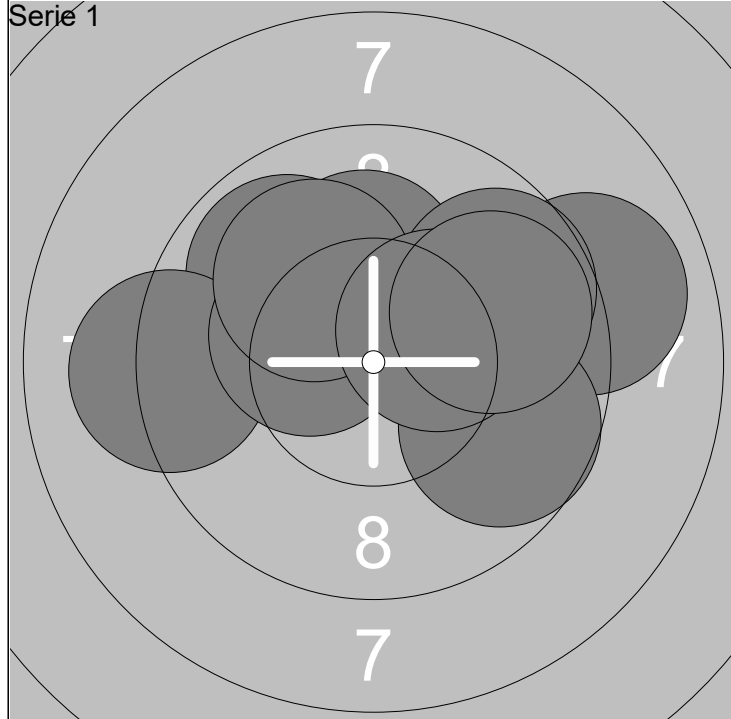

1: 9.9 ↖	6: 9.7 ↘	Serie	94
2: 9.2 ←	7: 10.1 ↗		
3: 9.0 →	8: 9.7 ↗	Total	94
4: 10.1 ↑	9: 10.3x ↗		
5: 10.3x ←	10: 9.8 ↗		

11: 9.2 ↖	16: 9.9 ↑	Serie	95
12: 9.0 ↗	17: 9.4 →		
13: 10.1 ↗	18: 9.4 ↗	Total	189
14: 10.2x ↖	19: 10.6x →		
15: 10.7x ↘	20: 10.3x ←		

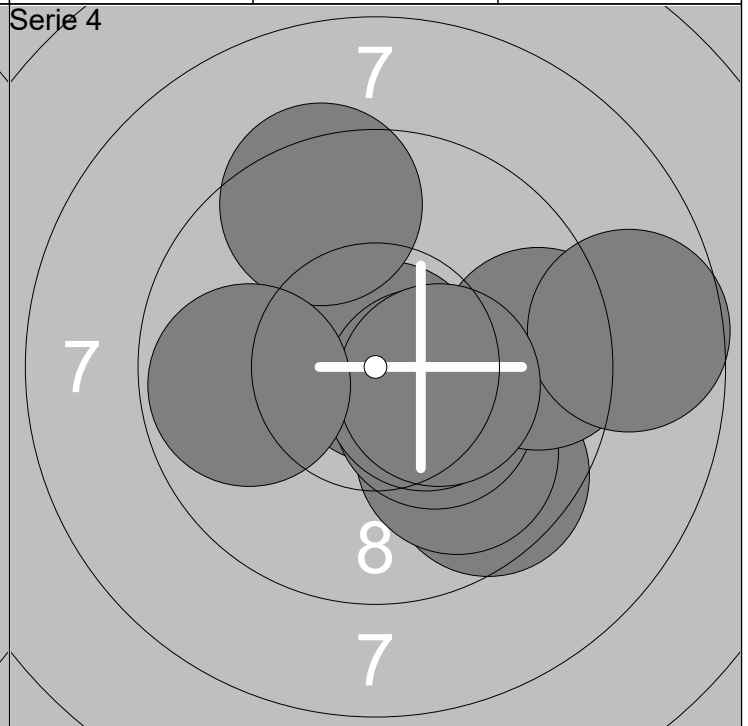
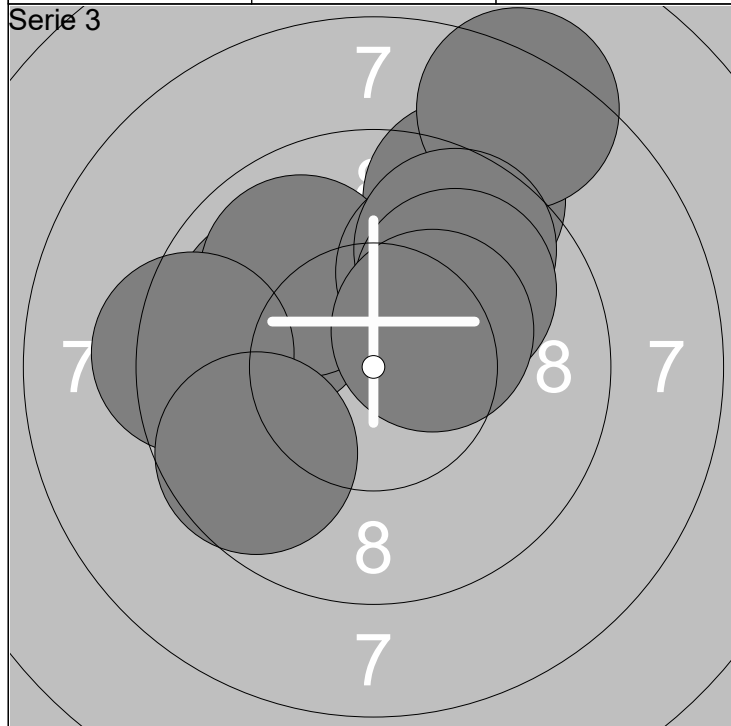

21: 9.3 ↗	26: 9.7 ↗	Serie	92
22: 8.3 ↗	27: 10.0 ↗		
23: 10.0 ↖	28: 9.4 ←	Total	281
24: 9.9 ↖	29: 9.7 ↙		
25: 9.9 ↗	30: 10.4x ↗		

31: 10.9x ↗	36: 10.5x ↘	Serie	93
32: 9.6 ↘	37: 9.5 →		
33: 9.9 ↘	38: 8.7 →	Total	374
34: 10.3x ↘	39: 10.4x →		
35: 9.4 ↗	40: 9.8 ←		

Serie 1

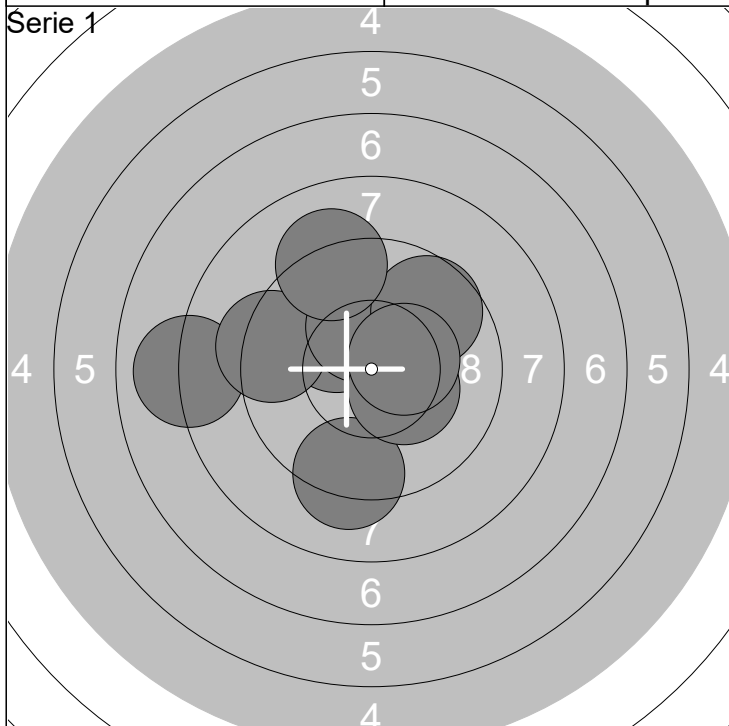

1:	10.6x	↑	6:	10.3x	↑
2:	9.2	↓	7:	9.7	↗
3:	10.2x	↖	8:	10.3x	↘
4:	8.0	←	9:	10.4x	→
5:	9.3	↙	10:	9.2	↑

Serie	94
Total	94

Serie 2

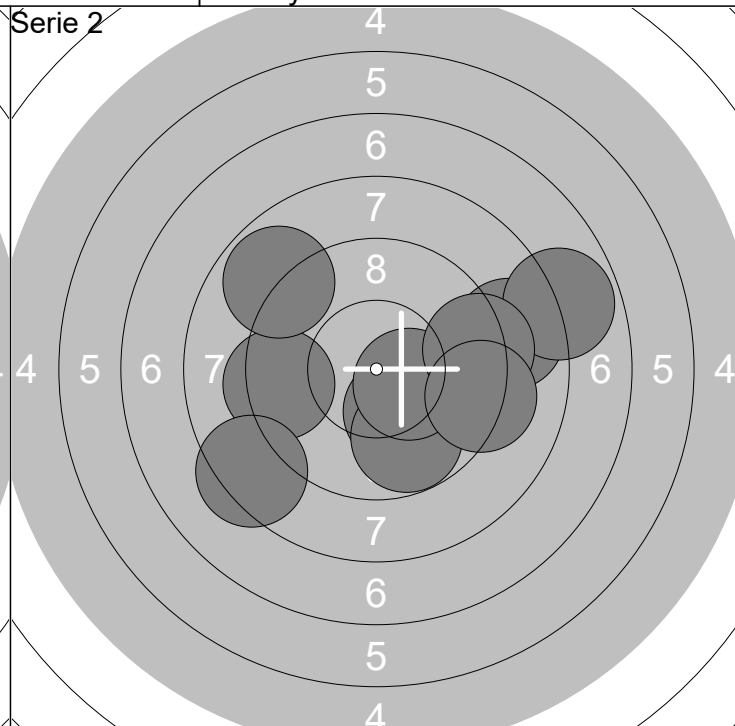

11:	10.2x	↓	16:	10.4x	↘
12:	8.8	→	17:	8.4	↙
13:	9.4	←	18:	7.9	→
14:	9.8	↓	19:	9.3	→
15:	8.9	↖	20:	9.2	↘

Serie	87
Total	181

Serie 3

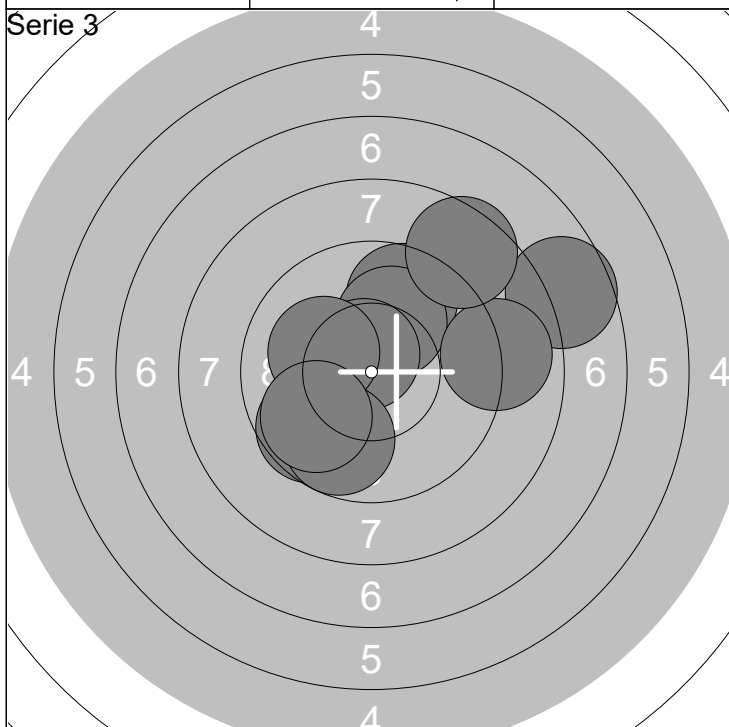

21:	9.7	↑	26:	7.7	↗
22:	9.6	↙	27:	8.9	→
23:	10.1	↑	28:	9.7	↓
24:	10.6x	↑	29:	9.8	↙
25:	10.1	↙	30:	8.5	↗

Serie	89
Total	270

Serie 4

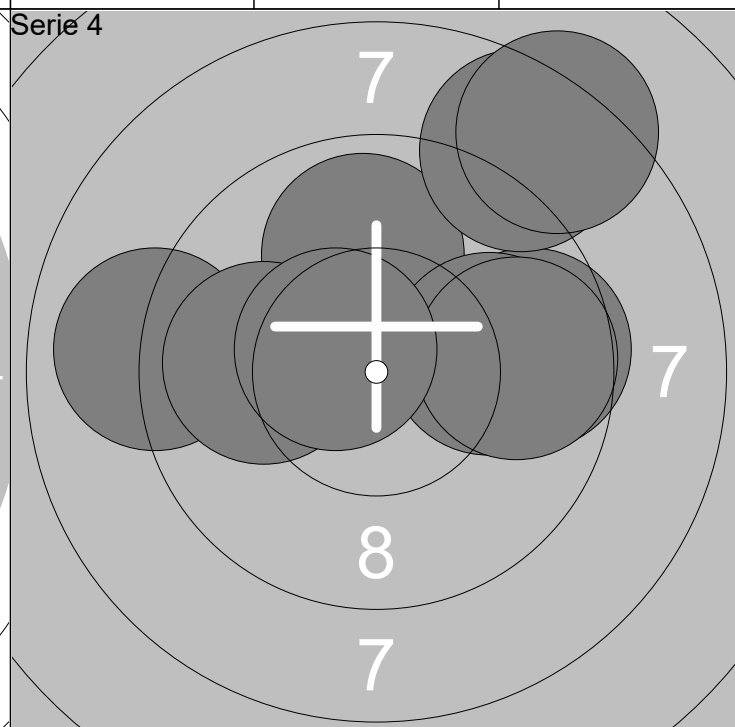

31:	10.4x	↙	36:	8.6	↗
32:	9.0	←	37:	9.9	←
33:	9.9	↑	38:	9.7	→
34:	9.6	→	39:	10.5x	↙
35:	10.0	→	40:	8.3	↗

Serie	91
Total	361

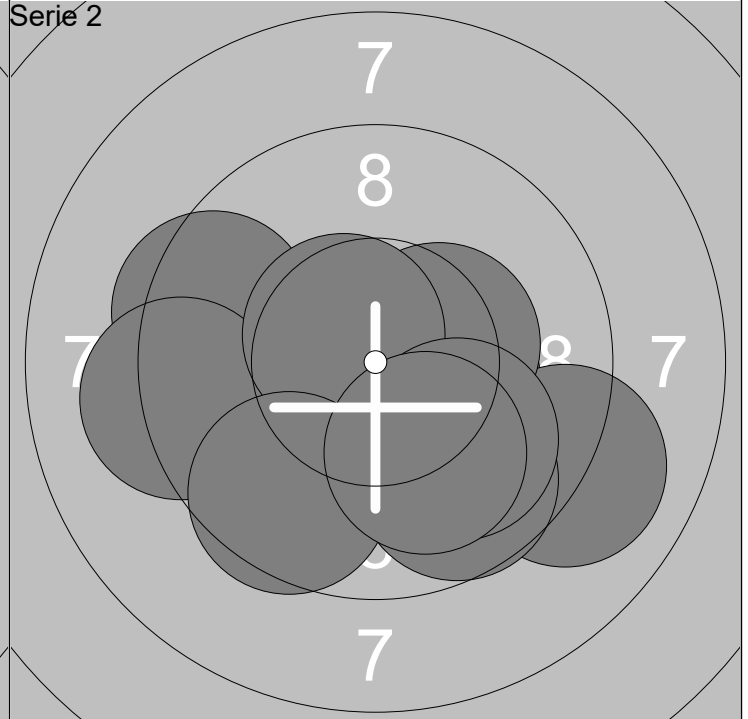
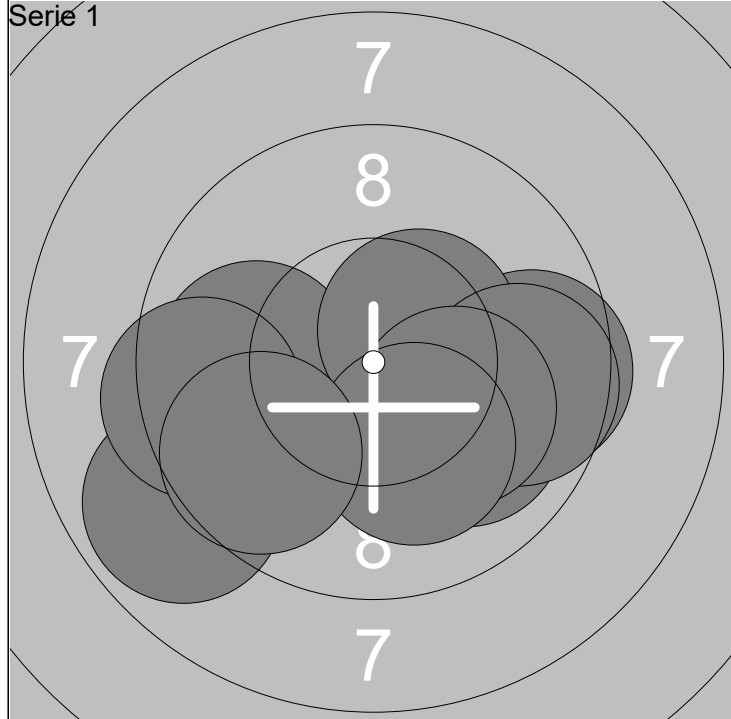

1: 8.9 ↙	6: 9.4 ←	Serie	93
2: 10.0 ↘	7: 9.7 →		
3: 9.5 →	8: 10.1 ↘	Total	93
4: 9.9 ←	9: 10.1 ↘		
5: 10.4x ↗	10: 9.7 ↙		

11: 10.4x →	16: 9.7 ↘	Serie	95
12: 9.5 ←	17: 10.6x ↗		
13: 9.0 ↘	18: 10.0 ↘	Total	188
14: 10.4x →	19: 9.6 ↘		
15: 9.2 ←	20: 10.0 ↘		

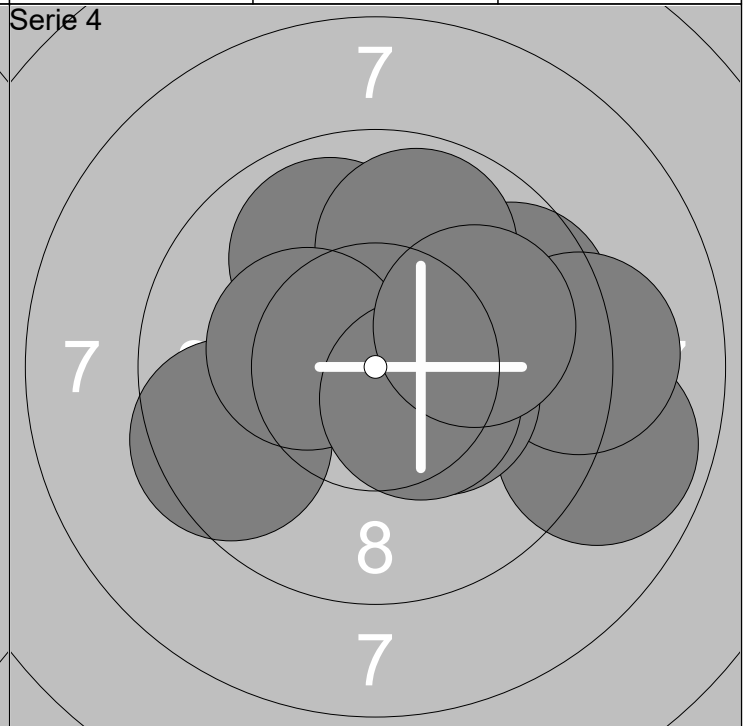
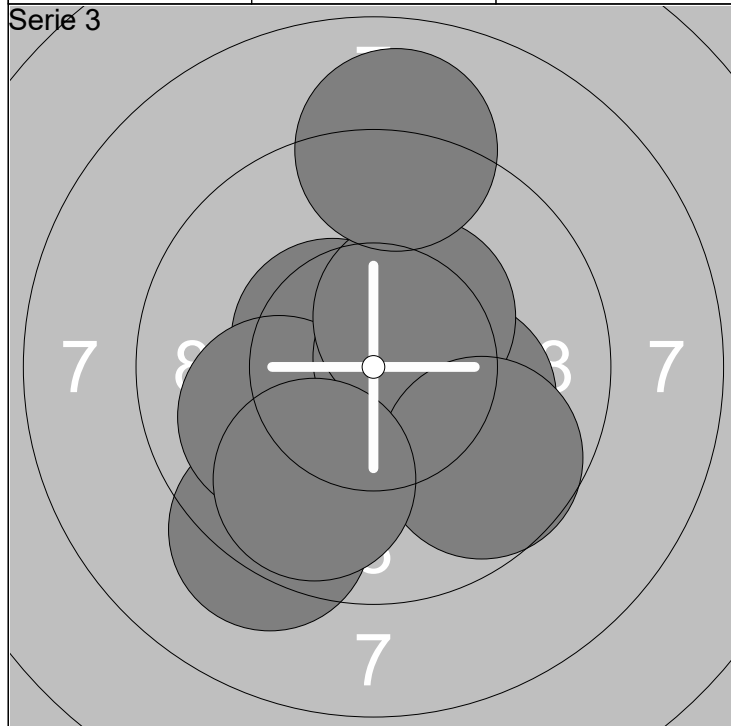

21: 9.3 ↘	26: 10.2x →	Serie	96
22: 10.5x ↖	27: 10.4x ↗		
23: 10.0 ↙	28: 9.7 ↘	Total	284
24: 10.2x ↘	29: 9.8 ↘		
25: 10.6x →	30: 9.0 ↑		

31: 8.9 →	36: 9.8 ↑	Serie	93
32: 9.6 ↗	37: 10.3x ↘		
33: 9.1 →	38: 10.3x ←	Total	377
34: 9.5 ←	39: 10.5x ↘		
35: 9.9 ↗	40: 10.0 →		

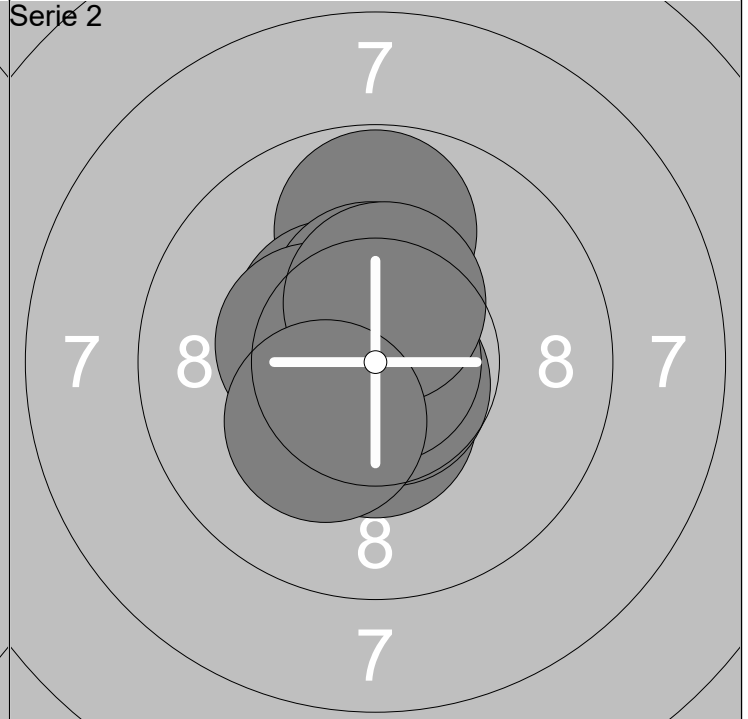
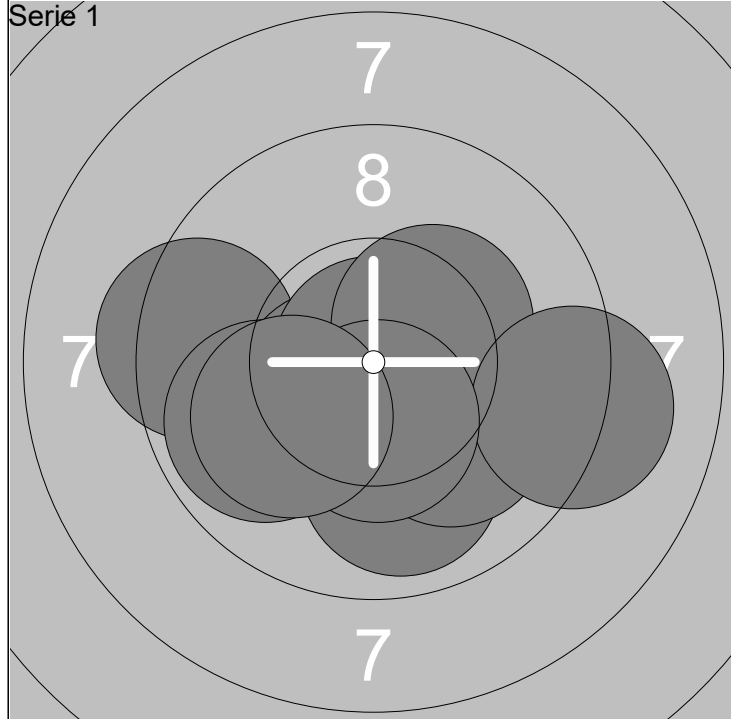

1: 9.4 ←	6: 10.3x ↗	Serie 96
2: 10.6x ↙	7: 9.1 →	
3: 9.9 ↓	8: 9.8 ↙	Total 96
4: 10.9x ↑	9: 10.4x ↓	
5: 10.0 ↘	10: 10.1 ↙	

11: 9.8 ↑	16: 10.9x →	Serie 99
12: 10.4x ↖	17: 10.4x ↑	
13: 10.7x ↓	18: 10.4x ↙	Total 195
14: 10.5x ↓	19: 10.4x ↑	
15: 10.7x ↘	20: 10.3x ↙	

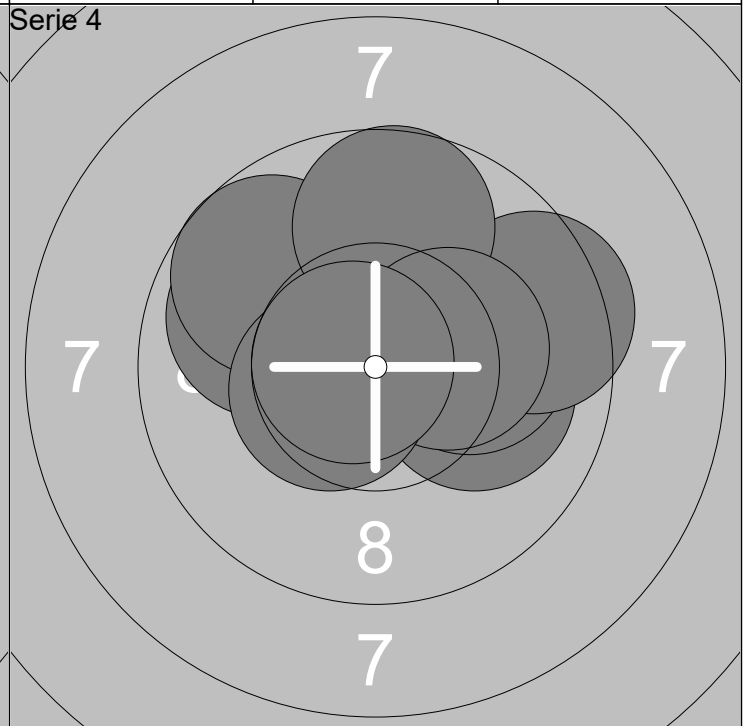
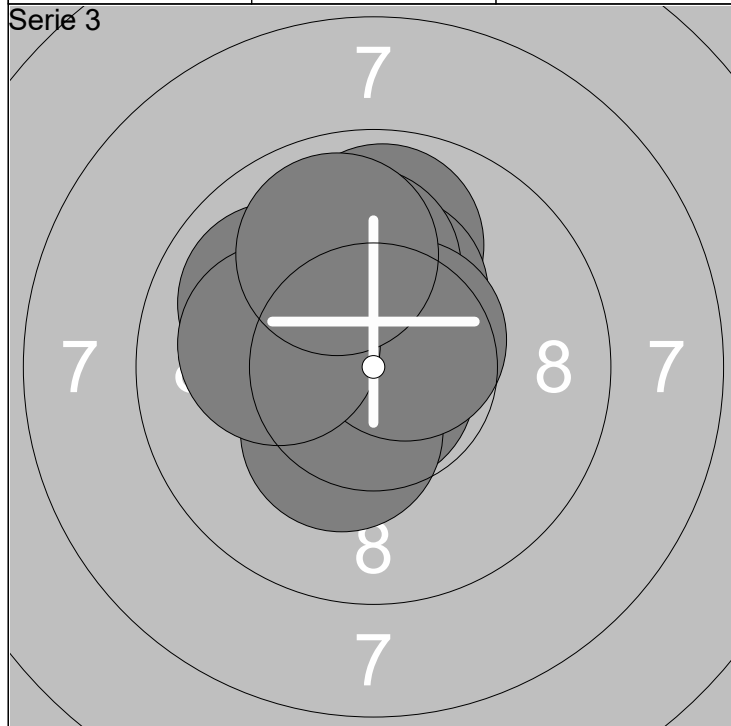

21: 10.6x ↖	26: 10.3x ↓	Serie 98
22: 9.8 ↑	27: 10.6x ↗	
23: 10.3x ↑	28: 10.0 ↙	Total 293
24: 10.8x ↓	29: 10.1 ↙	
25: 10.1 ↑	30: 9.9 ↑	

31: 10.6x ↙	36: 9.5 →	Serie 96
32: 9.9 ↙	37: 9.7 ↑	
33: 10.1 →	38: 10.3x →	Total 389
34: 10.1 →	39: 10.5x ↙	
35: 9.7 ↗	40: 10.7x ↙	

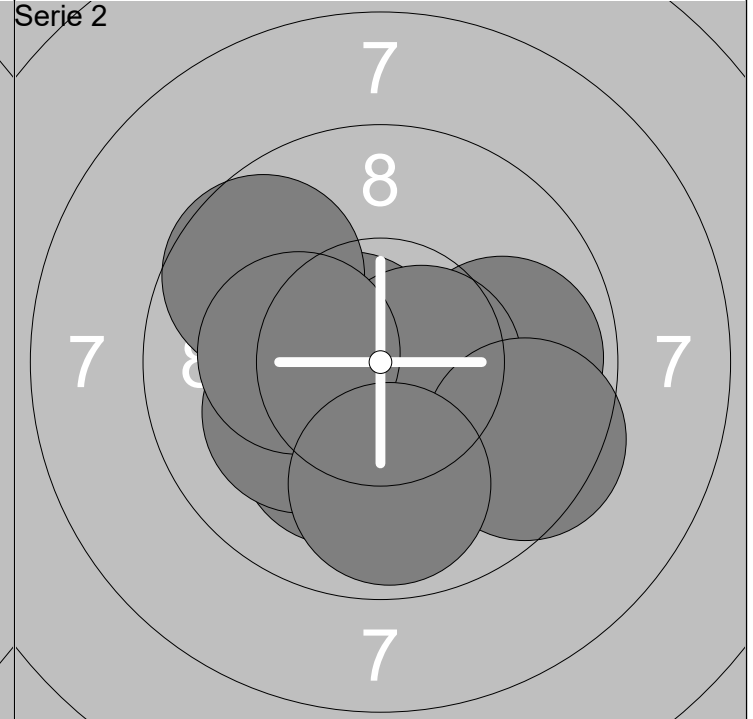
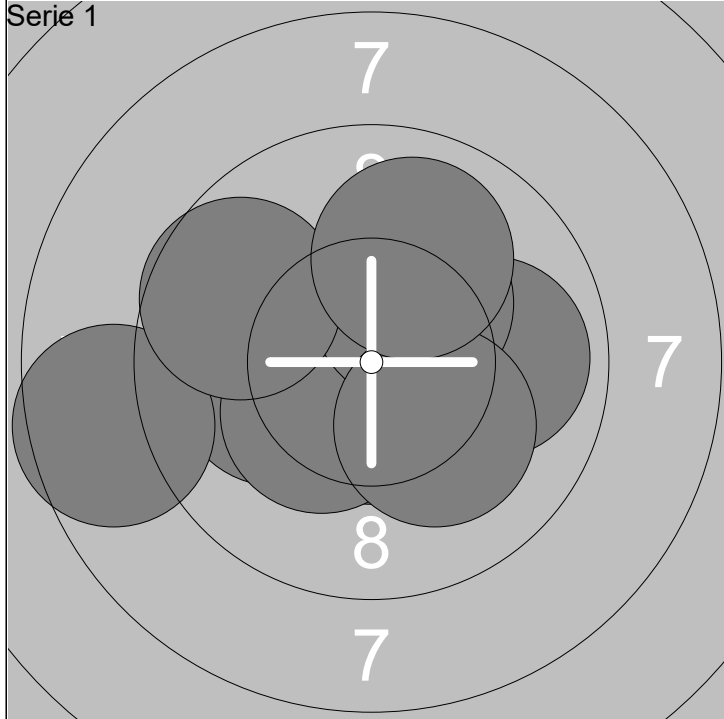

1: 10.6x ↓	6: 8.6 ←	Serie	96
2: 10.1 ←	7: 10.3x ↗		
3: 10.4x →	8: 10.2x ↘	Total	96
4: 9.9 →	9: 9.7 ↖		
5: 10.3x ↙	10: 10.0 ↗		

11: 10.1 ↘	16: 9.7 ↗	Serie	96
12: 10.6x ←	17: 10.6x →		
13: 9.9 →	18: 10.2x ←	Total	192
14: 10.1 ↓	19: 9.5 ↘		
15: 10.1 ↙	20: 9.9 ↓		

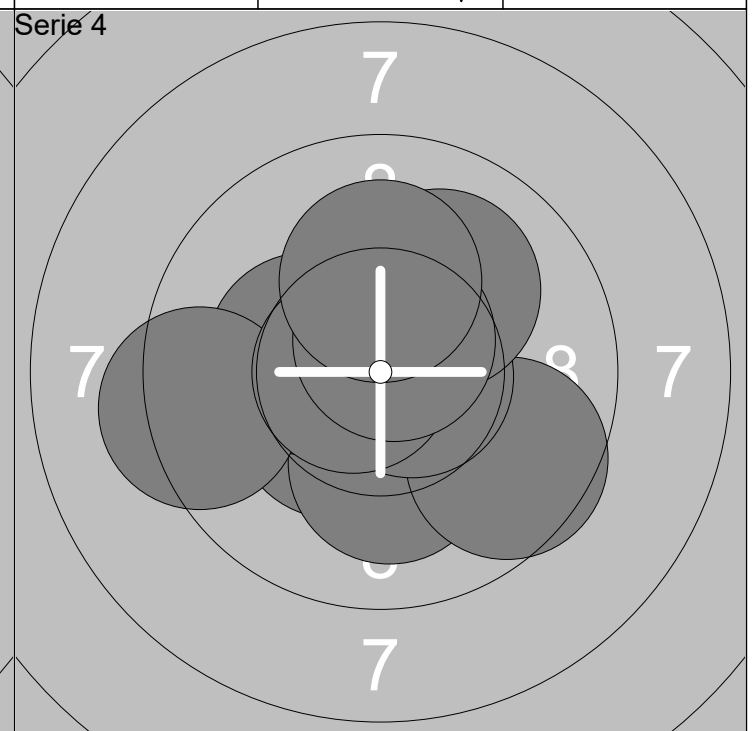
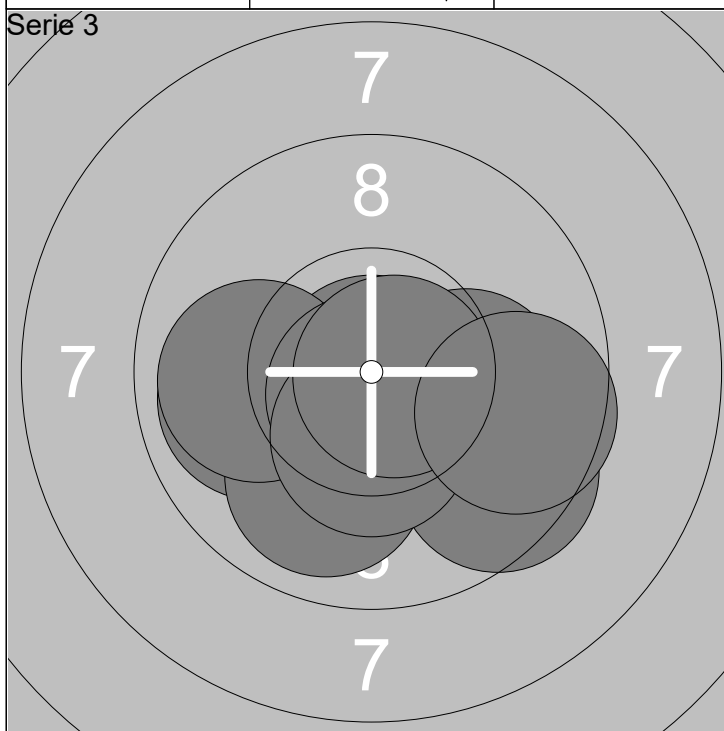

21: 9.9 ←	26: 9.9 ←	Serie	96
22: 10.9x ↓	27: 10.7x ↓		
23: 10.1 →	28: 10.4x ↓	Total	288
24: 9.5 ↘	29: 10.7x →		
25: 10.0 ↙	30: 9.6 →		

31: 10.4x ↙	36: 9.3 ←	Serie	98
32: 10.1 ↓	37: 10.0 ↗		
33: 10.3x ←	38: 10.7x ←	Total	386
34: 9.6 ↘	39: 10.6x ↗		
35: 10.7x →	40: 10.1 ↑		

Serie 1

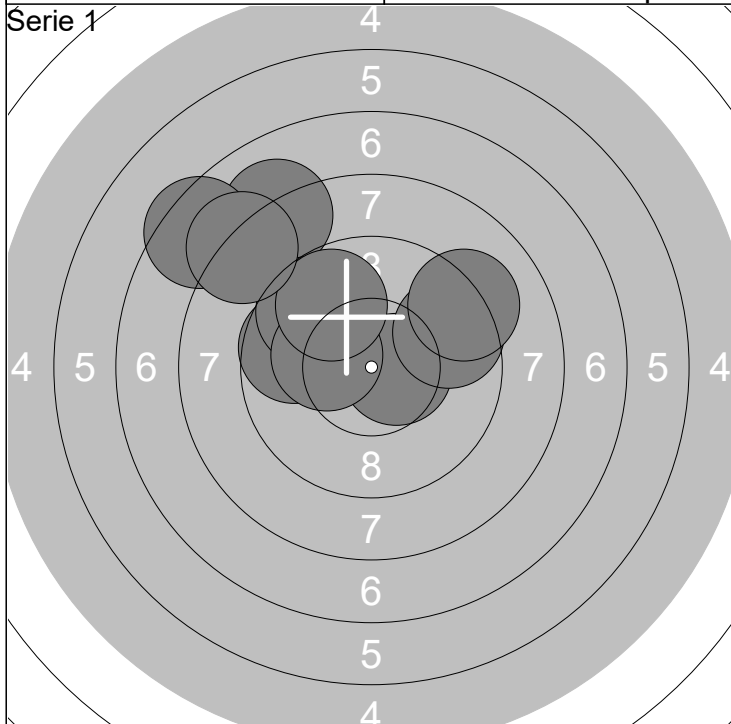

Serie 2

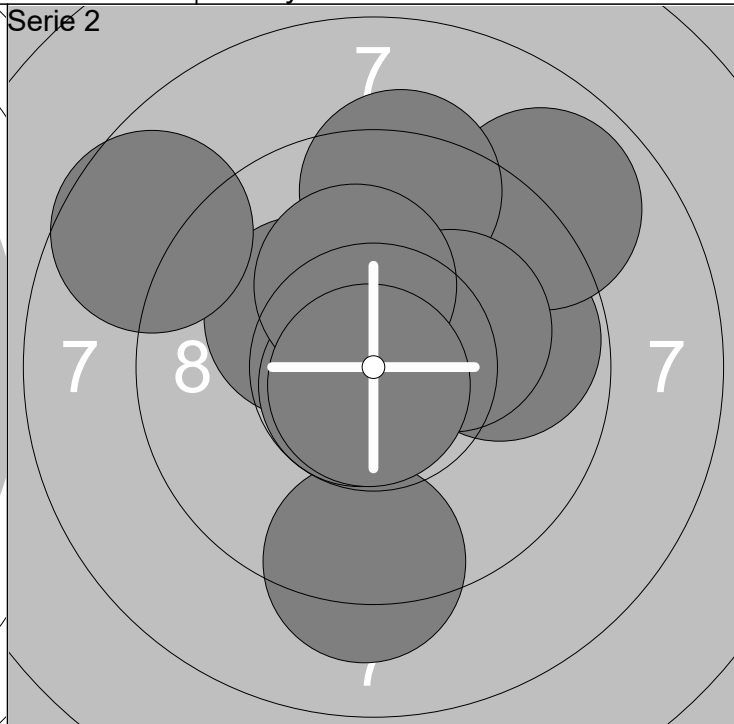

1: 8.1 ↗	6: 10.2x ↖	Serie	88	11: 10.2x ↖	16: 9.2 ↓	Serie	93
2: 9.6 ↖	7: 9.8 ↗			12: 9.8 →	17: 10.7x ↘		
3: 10.5x →	8: 9.2 ↗	Total	88	13: 8.9 ↗	18: 8.6 ↖	Total	181
4: 9.6 ↗	9: 7.5 ↖			14: 9.4 ↑	19: 10.2x ↑		
5: 9.6 ↗	10: 8.1 ↖			15: 10.2x ↗	20: 10.8x ↓		

Serie 3

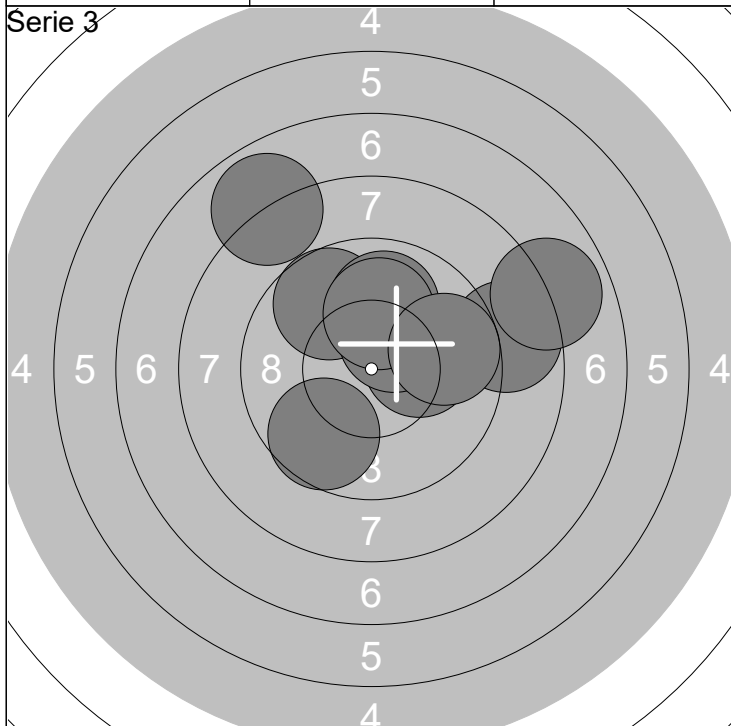

Serie 4

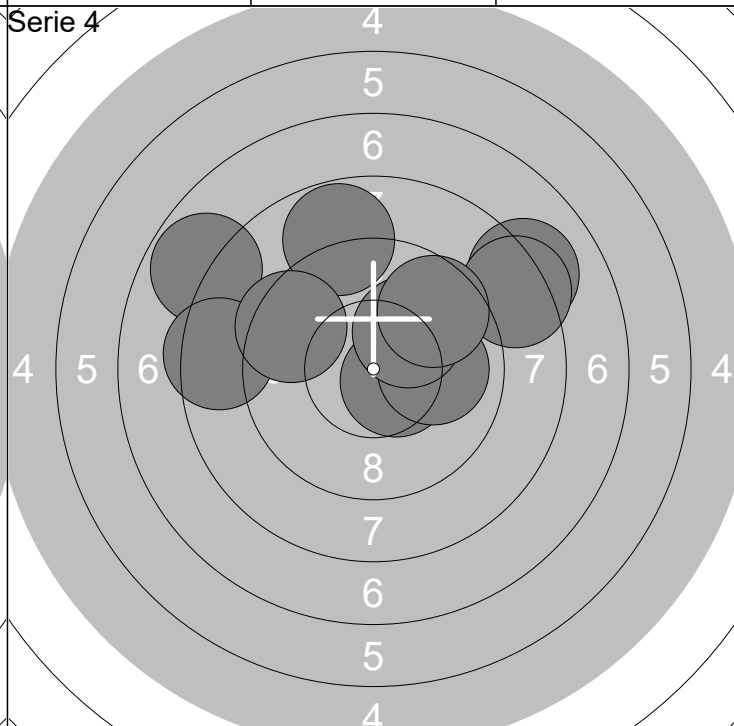

21: 8.7 →	26: 10.3x ↗	Serie	88	31: 10.5x →	36: 10.1 ↗	Serie	87
22: 9.7 ↖	27: 10.0 ↑			32: 7.8 ↖	37: 9.6 ↗		
23: 7.9 →	28: 9.7 ↘	Total	269	33: 8.1 ↗	38: 8.5 ↖	Total	356
24: 9.9 ↑	29: 7.9 ↖			34: 10.0 →	39: 8.8 ↑		
25: 10.2x →	30: 9.7 →			35: 8.4 ↗	40: 9.5 ↖		

Serie 1

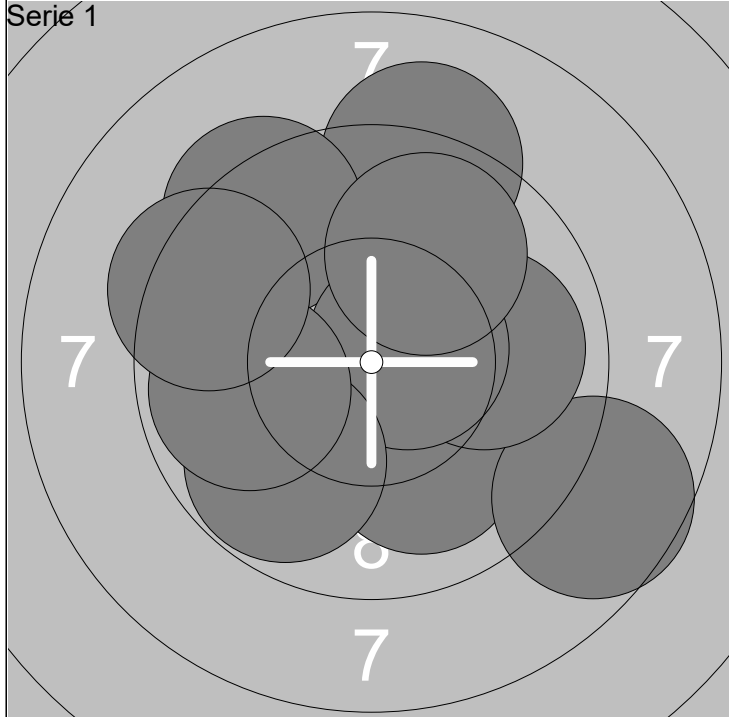

1:	10.0	↘	6:	10.6x	→
2:	8.6	↘	7:	9.8	↙
3:	9.9	→	8:	9.9	↗
4:	9.1	↗	9:	9.8	←
5:	9.3	↖	10:	9.4	←

Serie 91

Total 91

Serie 2

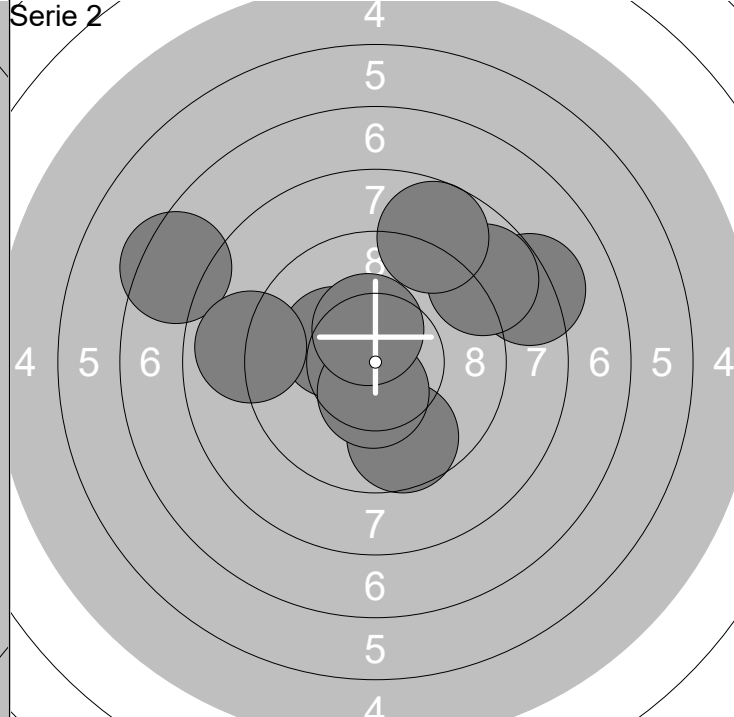

11:	10.6x	←	16:	8.8	↗
12:	7.4	←	17:	10.5x	↘
13:	8.2	→	18:	10.4x	↗
14:	9.7	↘	19:	8.9	←
15:	10.2x	←	20:	8.7	↗

Serie 88

Total 179

Serie 3

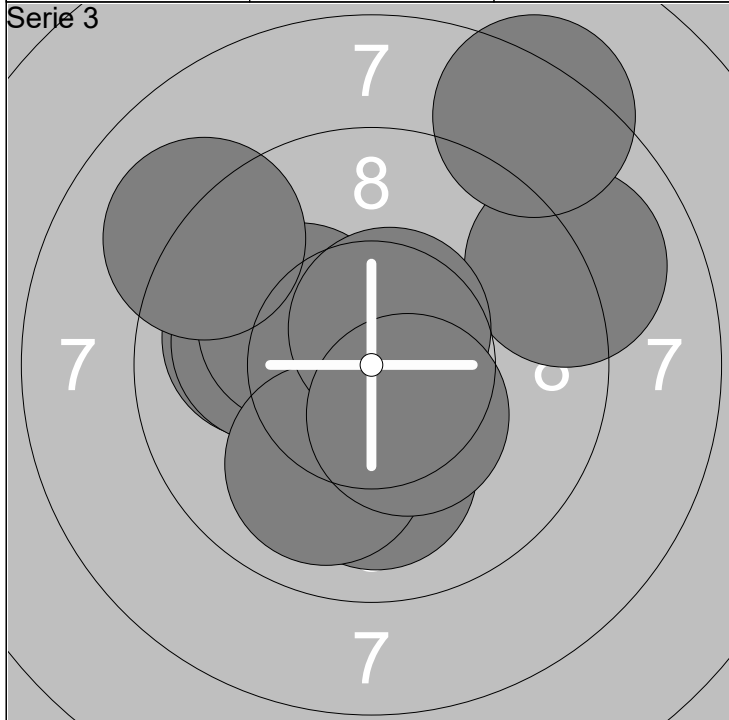

21:	10.0	←	26:	10.0	↘
22:	10.0	←	27:	10.6x	↗
23:	10.0	↘	28:	10.4x	↘
24:	9.0	↗	29:	9.1	↖
25:	10.2x	←	30:	8.3	↗

Serie 96

Total 275

Serie 4

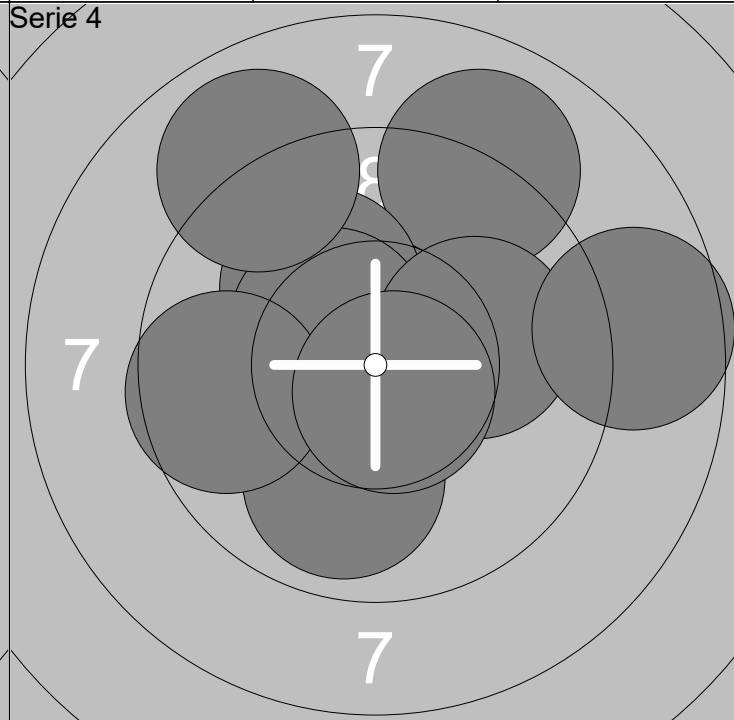

31:	9.0	↗	36:	9.6	←
32:	10.7x	↗	37:	8.9	↗
33:	10.1	↖	38:	10.0	→
34:	9.9	↘	39:	10.6x	↘
35:	10.4x	↖	40:	8.6	→

Serie 93

Total 368

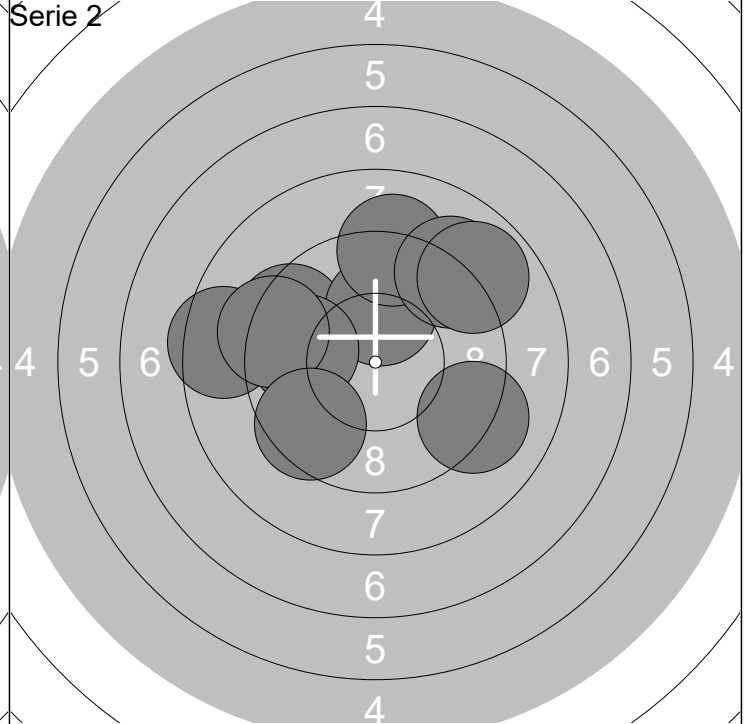
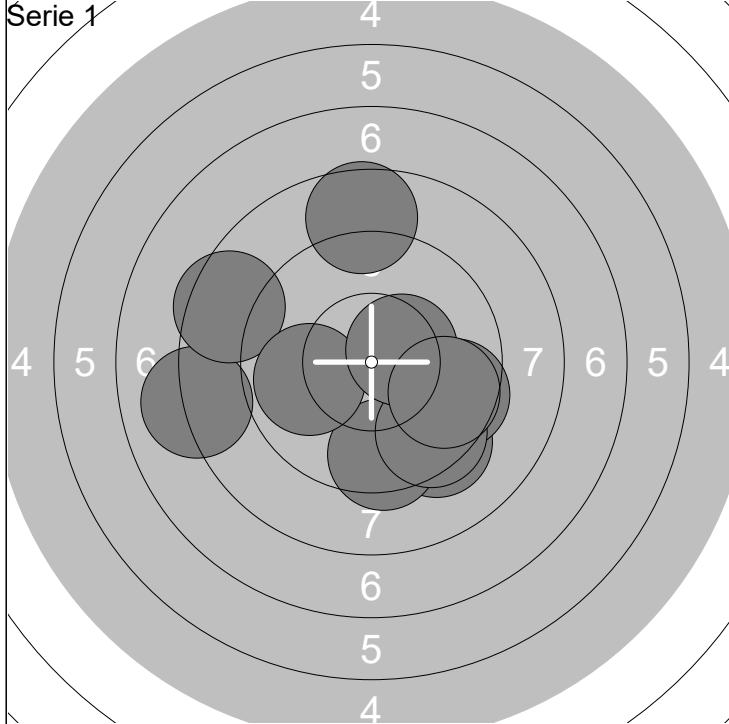

1: 9.3 ↘	6: 9.5 ↘	Serie	88
2: 8.1 ←	7: 8.6 ↑		
3: 8.5 ↖	8: 9.9 ←	Total	88
4: 9.5 ↓	9: 10.4x →		
5: 9.5 →	10: 9.7 ↘		

11: 9.4 ↖	16: 9.7 ←	Serie	89
12: 9.1 →	17: 9.2 ←		
13: 8.5 ←	18: 9.1 ↗	Total	177
14: 10.1 ↑	19: 8.9 ↗		
15: 9.1 ↑	20: 9.5 ↘		

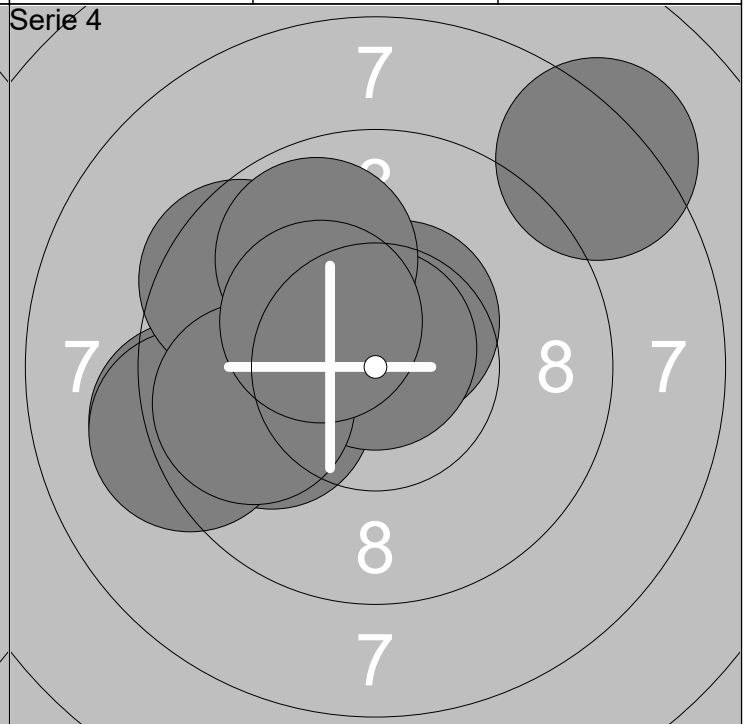
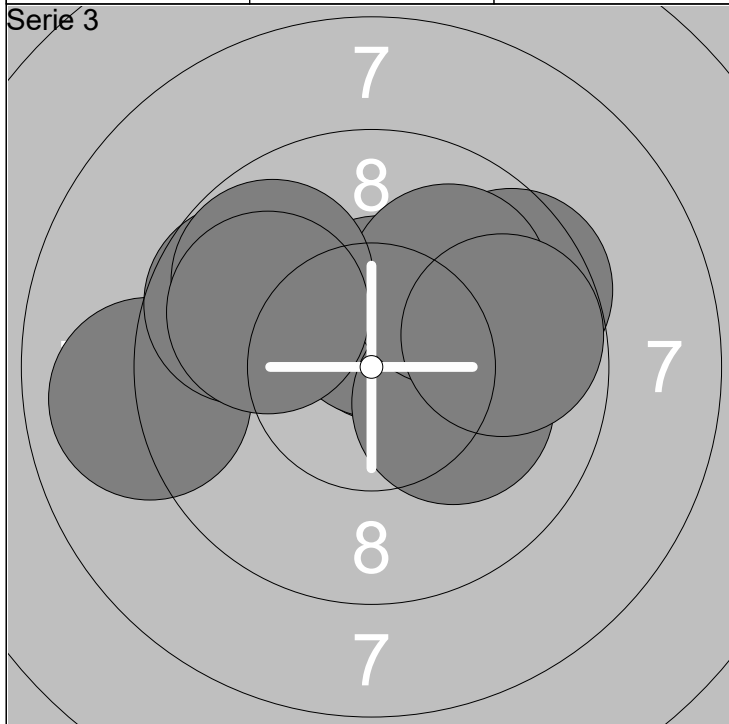

21: 10.5x ↑	26: 10.0 ↗	Serie	94
22: 10.5x ↑	27: 9.7 ←		
23: 9.5 ↗	28: 9.8 ↖	Total	271
24: 10.2x →	29: 9.9 ←		
25: 9.0 ←	30: 9.7 →		

31: 9.2 ←	36: 9.5 ↖	Serie	93
32: 10.0 ←	37: 10.8x ↑		
33: 8.3 ↗	38: 9.9 ↗	Total	364
34: 9.2 ←	39: 9.8 ←		
35: 10.5x ↑	40: 10.3x ↖		

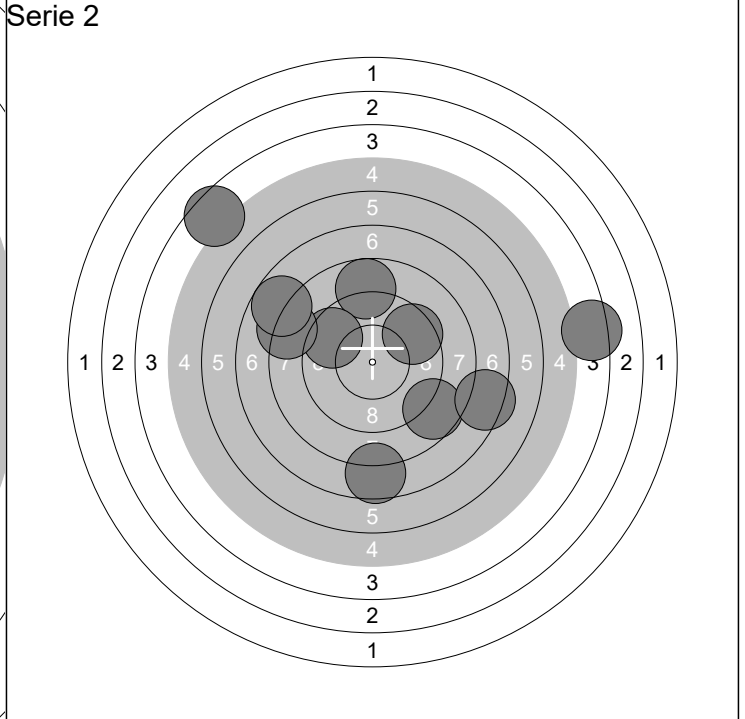
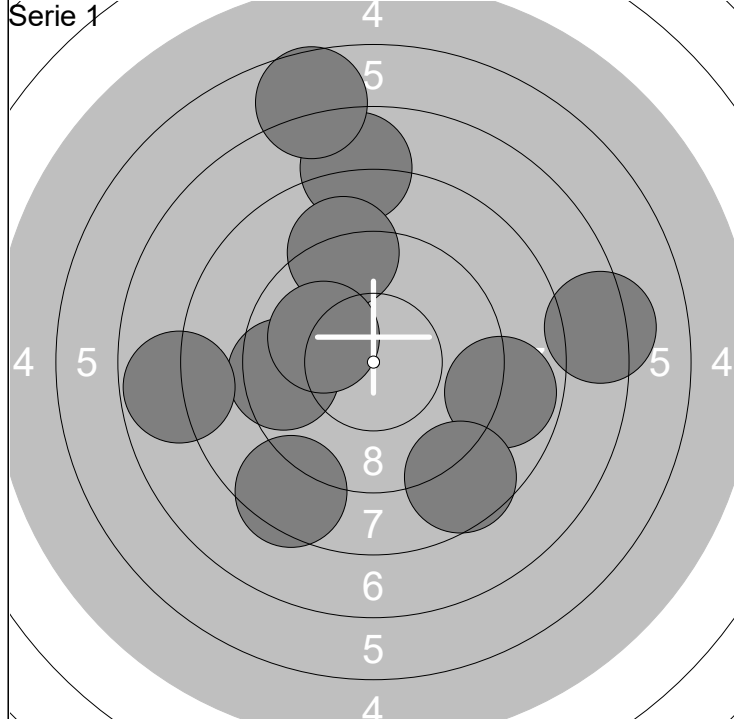

1: 7.8	↑	6: 9.1	↑	Serie	79
2: 8.8	→	7: 7.3	→		
3: 9.5	←	8: 6.7	↑	Total	79
4: 7.8	←	9: 8.5	↘		
5: 8.6	↘	10: 10.1	↖		

11: 7.6	↓	16: 4.5	↗	Serie	71
12: 8.7	↑	17: 8.2	↖		
13: 8.7	↘	18: 7.8	↗	Total	150
14: 9.5	↖	19: 9.5	↗		
15: 4.3	→	20: 7.4	→		

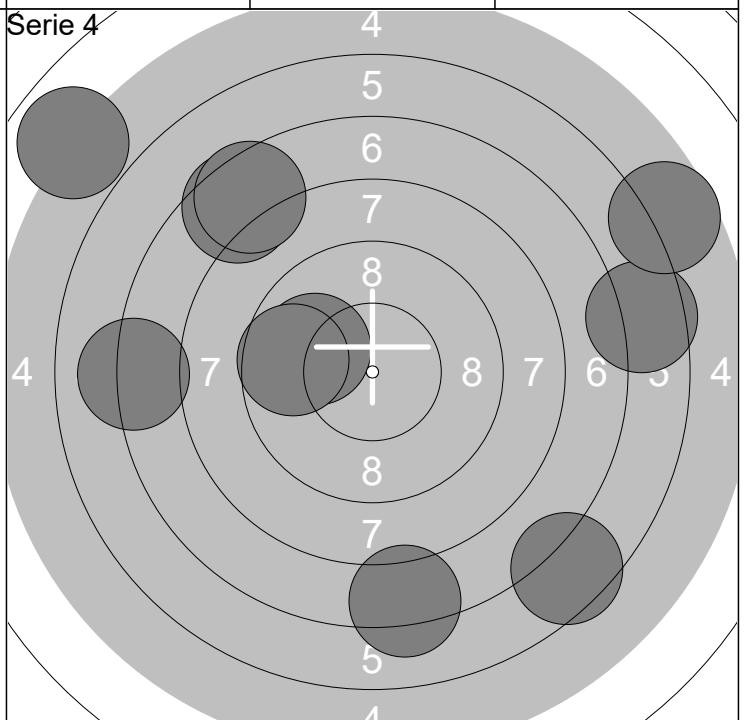
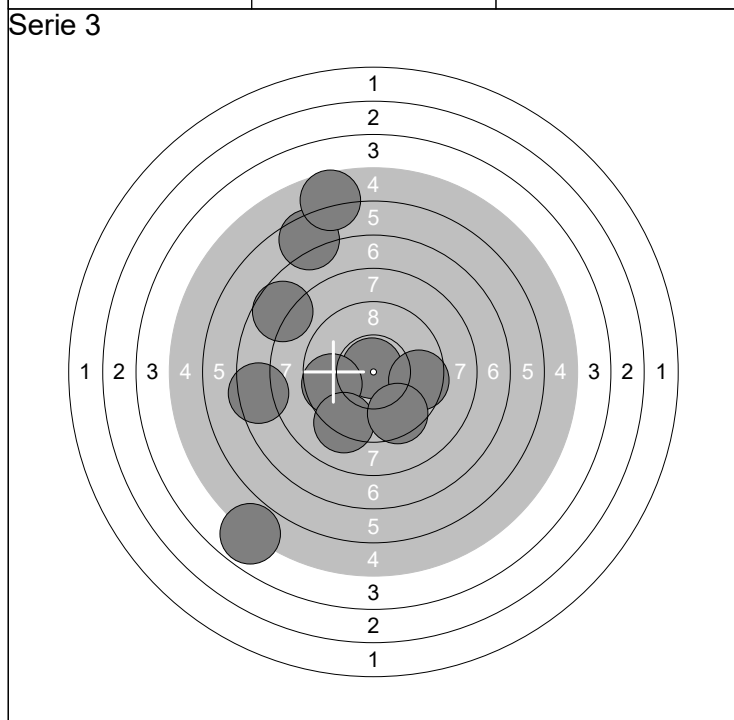

21: 10.8x	↑	26: 4.9	↘	Serie	75
22: 9.7	←	27: 9.2	↘		
23: 6.6	↑	28: 5.7	↑	Total	225
24: 9.6	→	29: 7.7	↗		
25: 7.5	←	30: 9.5	↘		

31: 10.0	↖	36: 4.9	↖	Serie	68
32: 6.5	→	37: 6.5	↘		
33: 7.2	↓	38: 7.1	←	Total	293
34: 9.7	←	39: 5.7	↗		
35: 7.5	↗	40: 7.5	↗		