

1: 10.2x ↓	6: 10.1 ↘	Serie	102.4
2: 10.0 ↗	7: 10.7x ↑		
3: 10.2x ↗	8: 9.0 ↑	Total	102.4
4: 10.6x ↓	9: 10.7x ↓		
5: 10.2x ←	10: 10.7x ↗		

11: 10.1 ↑	16: 10.5x ←	Serie	100.1
12: 9.6 ↙	17: 10.4x ↑		
13: 10.4x ←	18: 10.1 ↓	Total	202.5
14: 9.8 ↓	19: 8.8 ↙		
15: 10.0 ↑	20: 10.4x ↓		

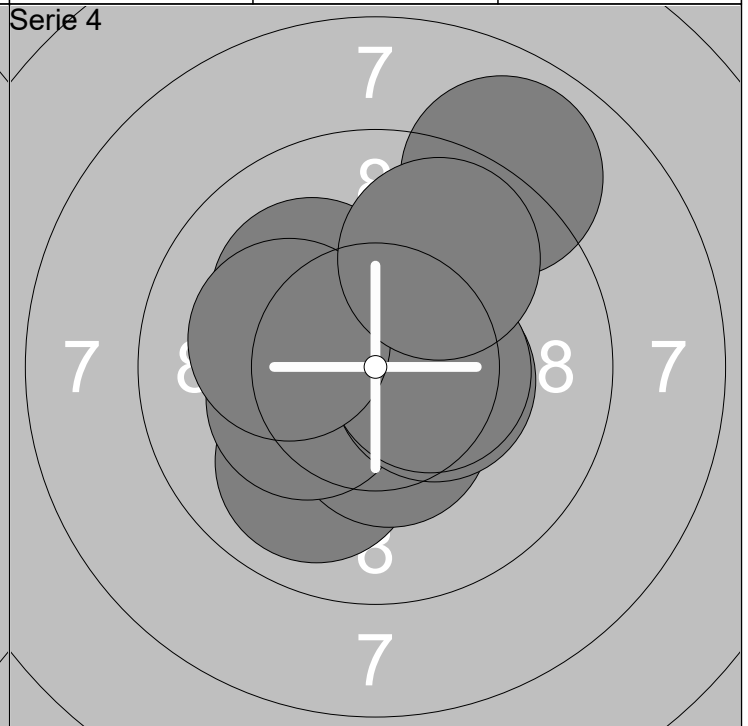
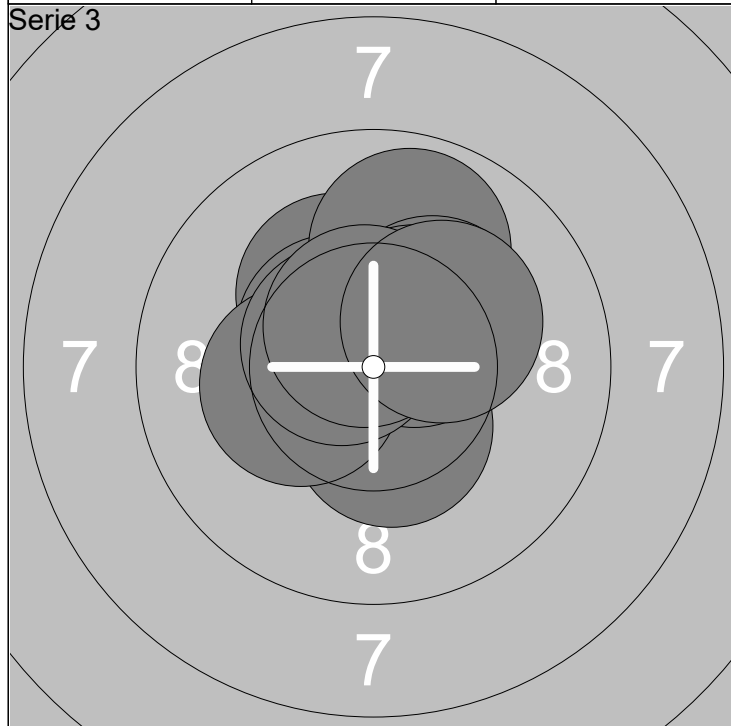

21: 10.2x ↑	26: 10.3x ↗	Serie	103.5
22: 10.5x ↖	27: 10.5x ↗		
23: 10.4x ↓	28: 10.6x ↖	Total	306.0
24: 10.3x ←	29: 10.6x ↑		
25: 9.9 ↑	30: 10.2x ↗		

31: 10.0 ↓	36: 10.4x →	Serie	101.1
32: 10.4x ↓	37: 10.5x →		
33: 10.1 ↖	38: 8.9 ↑	Total	407.1
34: 10.6x ←	39: 10.1 ←		
35: 10.3x ←	40: 9.8 ↑		

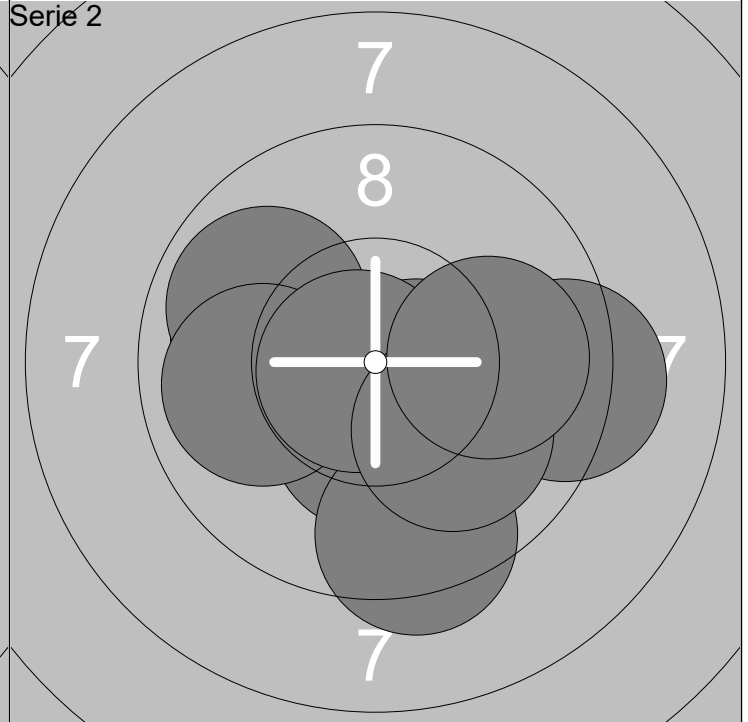
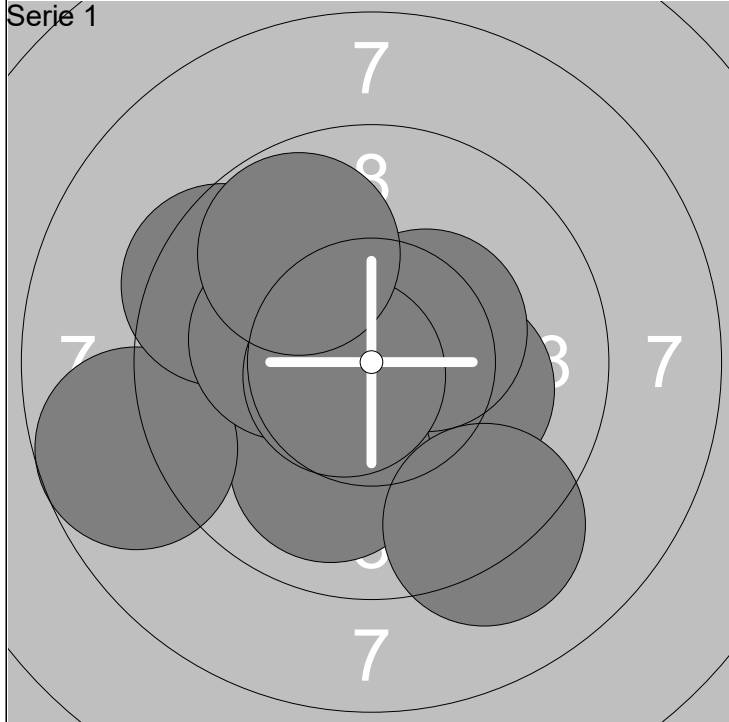

1: 10.2x →	6: 9.5 ↖	Serie 98.8
2: 10.4x ↗	7: 9.2 ↓	
3: 10.1 ↖	8: 10.2x ↖	Total 98.8
4: 10.0 ↓	9: 10.7x ↖	
5: 8.7 ←	10: 9.8 ↗	

11: 10.0 ←	16: 10.6x →	Serie 100.3
12: 9.9 ↖	17: 9.4 ↓	
13: 10.3x ↓	18: 10.8x ↖	Total 199.1
14: 9.9 ←	19: 10.1 ↓	
15: 9.3 →	20: 10.0 →	

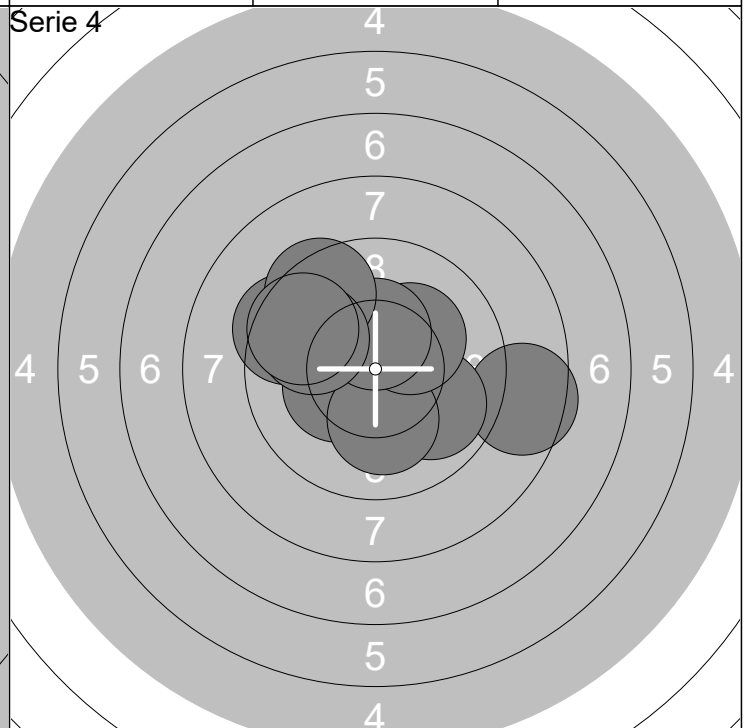
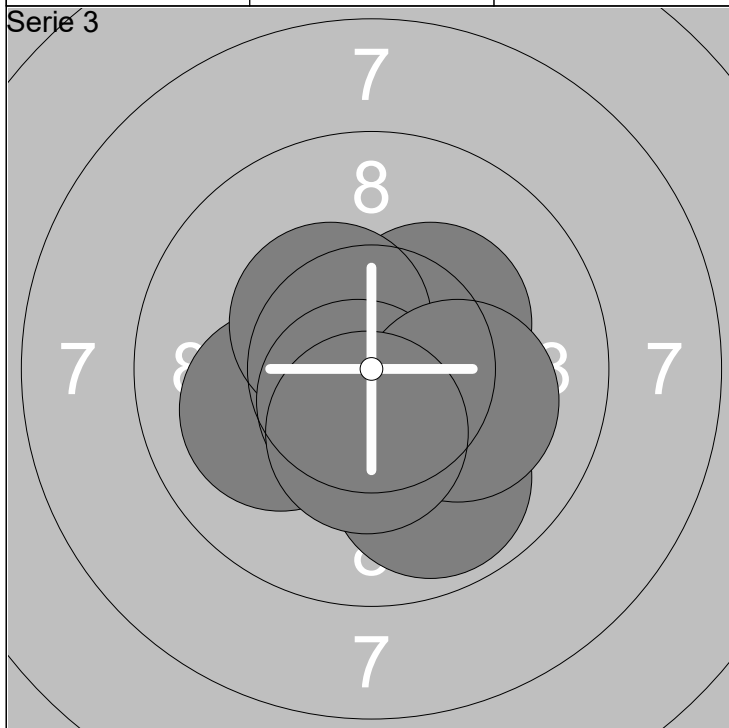

21: 10.1 ↖	26: 10.2x ↓	Serie 102.9
22: 10.6x ↗	27: 10.6x ↓	
23: 10.3x →	28: 9.9 ↓	Total 302.0
24: 10.3x ↗	29: 10.1 →	
25: 10.4x ↖	30: 10.4x ↓	

31: 8.6 →	36: 9.4 ↖	Serie 97.8
32: 10.3x ↖	37: 10.4x ↑	
33: 9.9 ↘	38: 9.5 ↗	Total 399.8
34: 10.1 ↓	39: 9.8 ↖	
35: 10.2x ↗	40: 9.6 ↖	

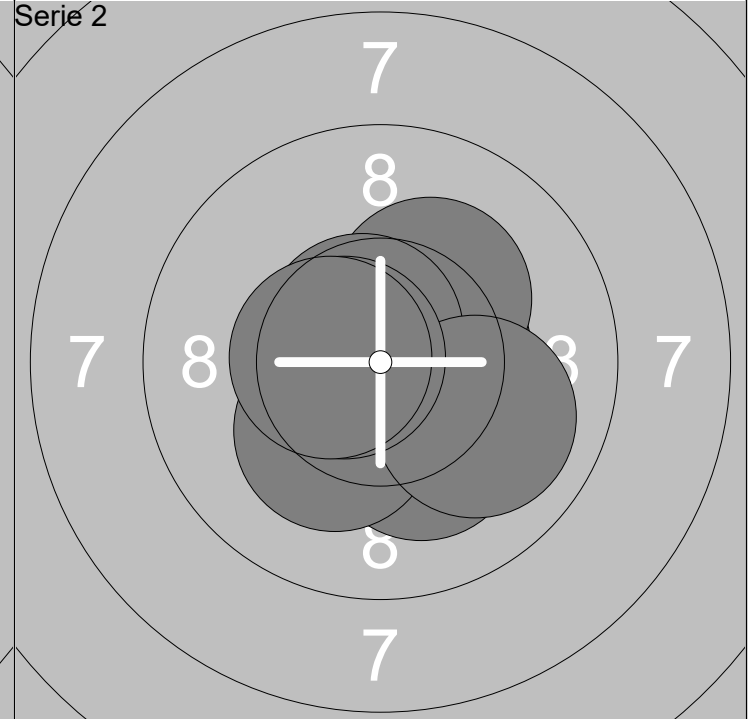
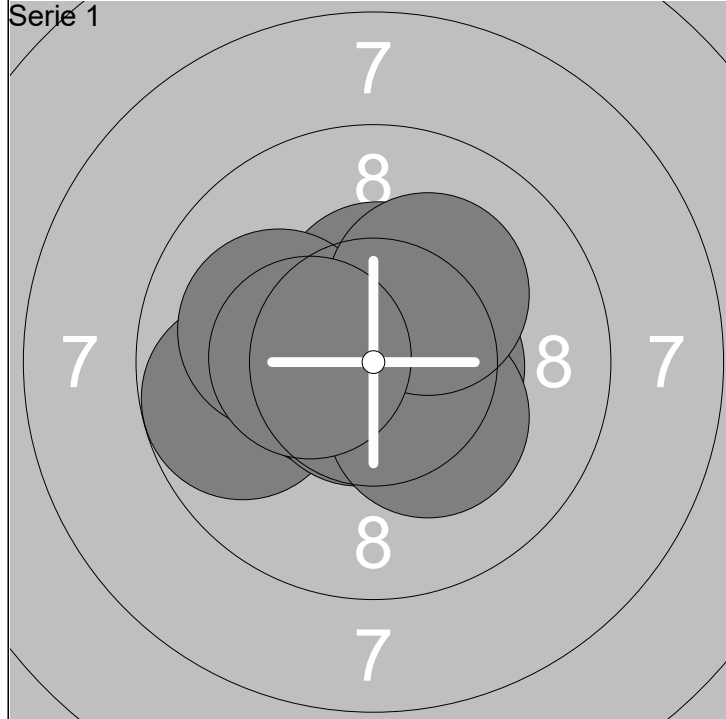

1: 10.6x ↖	6: 10.7x ↘	Serie	103.5
2: 10.4x ↑	7: 10.3x ↘		
3: 9.7 ←	8: 10.1 ←	Total	103.5
4: 10.6x ←	9: 10.2x ↗		
5: 10.5x →	10: 10.4x ←		

11: 10.5x →	16: 10.2x ↘	Serie	104.4
12: 10.8x ↑	17: 10.7x ↗		
13: 10.7x ↖	18: 10.0 ↘	Total	207.9
14: 10.2x ↘	19: 10.6x ←		
15: 10.2x ↗	20: 10.5x ←		

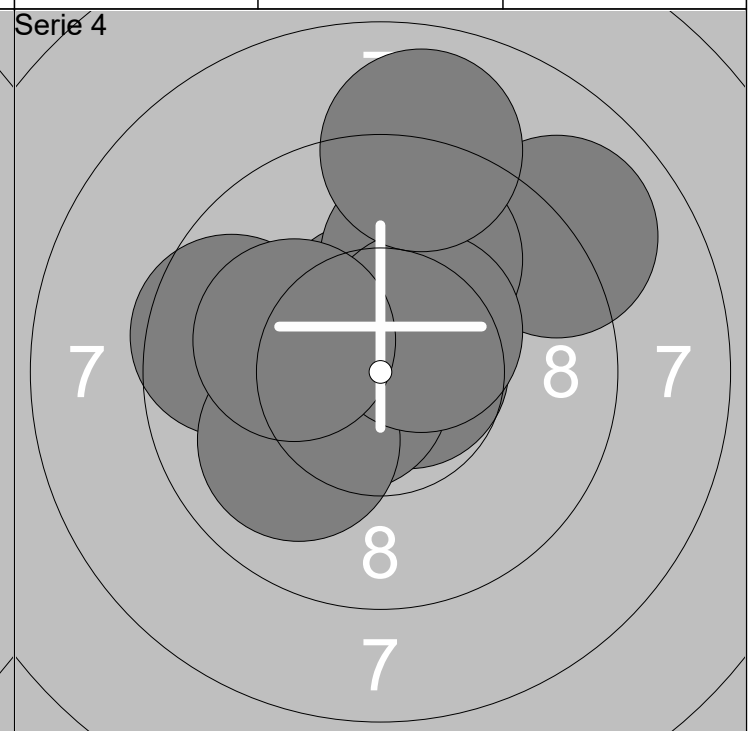
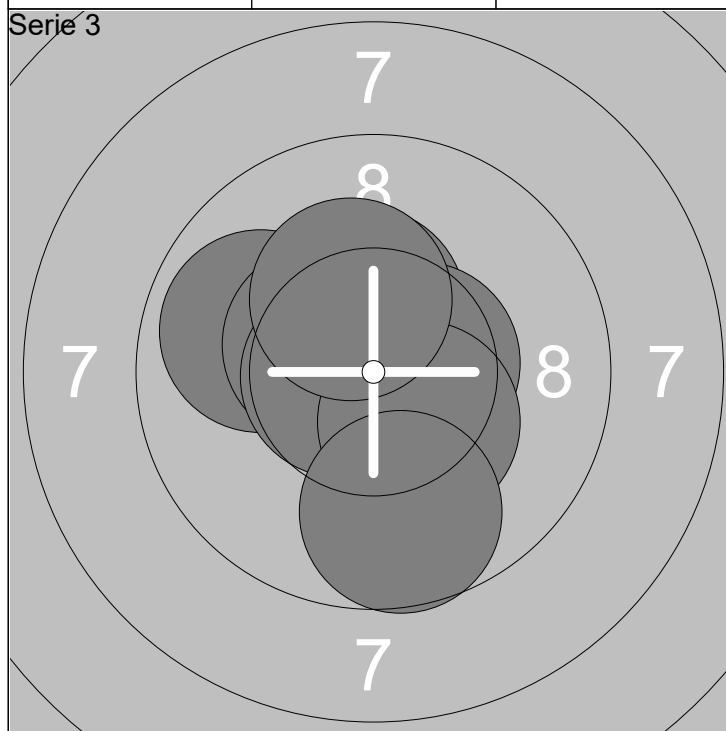

21: 10.4x ↑	26: 10.7x ←	Serie	103.7
22: 10.7x ↘	27: 10.6x →		
23: 9.9 ←	28: 10.4x ↘	Total	311.6
24: 10.6x ↘	29: 9.7 ↘		
25: 10.4x ↖	30: 10.3x ↗		

31: 10.5x ↑	36: 9.9 ↗	Serie	99.8
32: 9.6 ←	37: 10.0 ↘		
33: 10.7x →	38: 10.4x ↗	Total	411.4
34: 10.6x ←	39: 9.0 ↑		
35: 9.0 ↗	40: 10.1 ←		

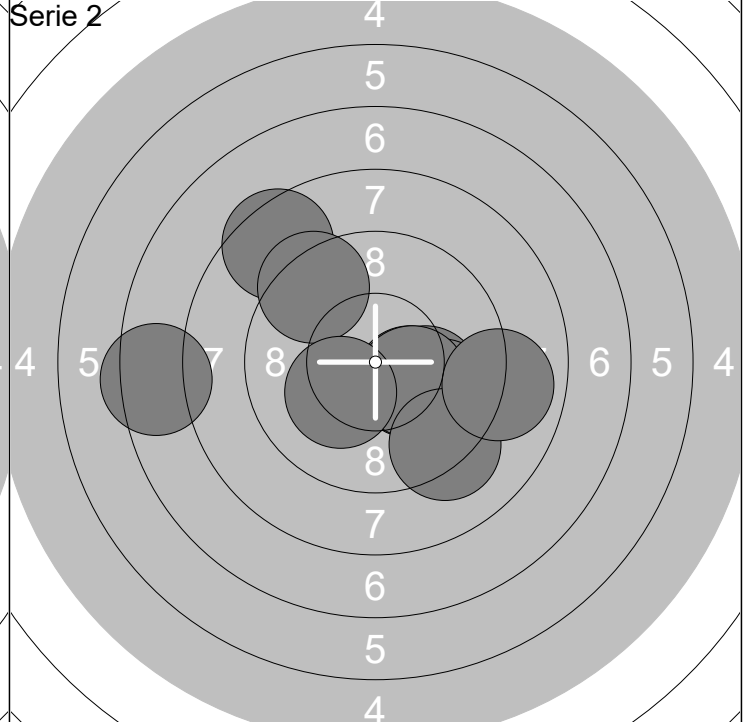
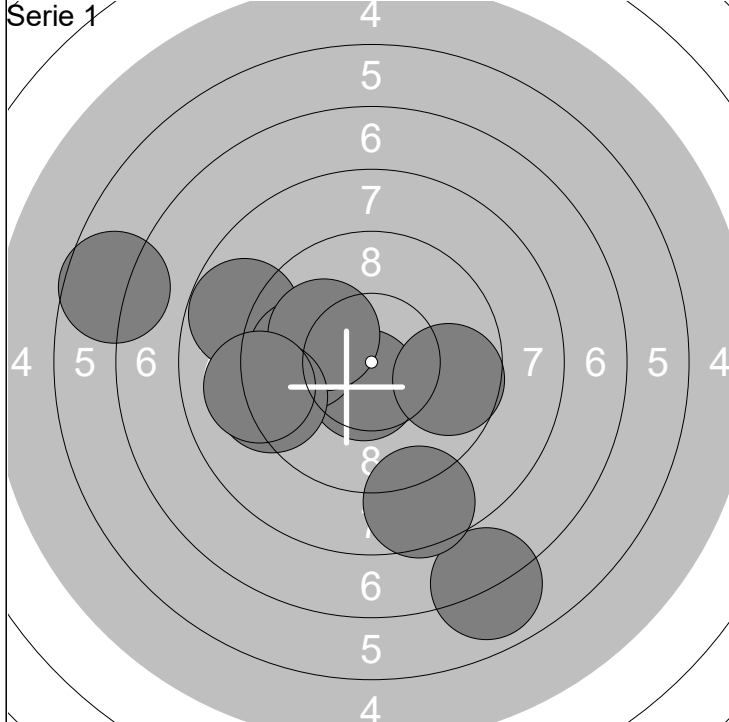

1: 8.8 ↖	6: 6.6 ↖	Serie	89.6
2: 7.0 ↘	7: 9.2 ↖		
3: 10.6x ↘	8: 9.1 ↖	Total	89.6
4: 9.9 ↖	9: 9.7 →		
5: 10.1 ↖	10: 8.6 ↘		

11: 10.1 →	16: 10.3x →	Serie	94.2
12: 9.8 →	17: 9.2 ↘		
13: 8.5 ↗	18: 10.2x ↖	Total	183.8
14: 10.3x ↘	19: 9.0 →		
15: 9.4 ↗	20: 7.4 ←		

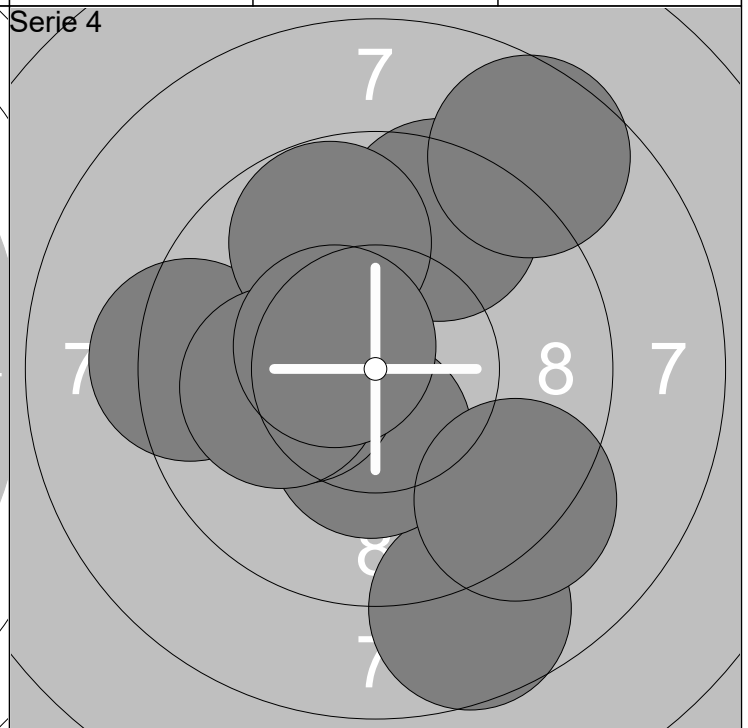
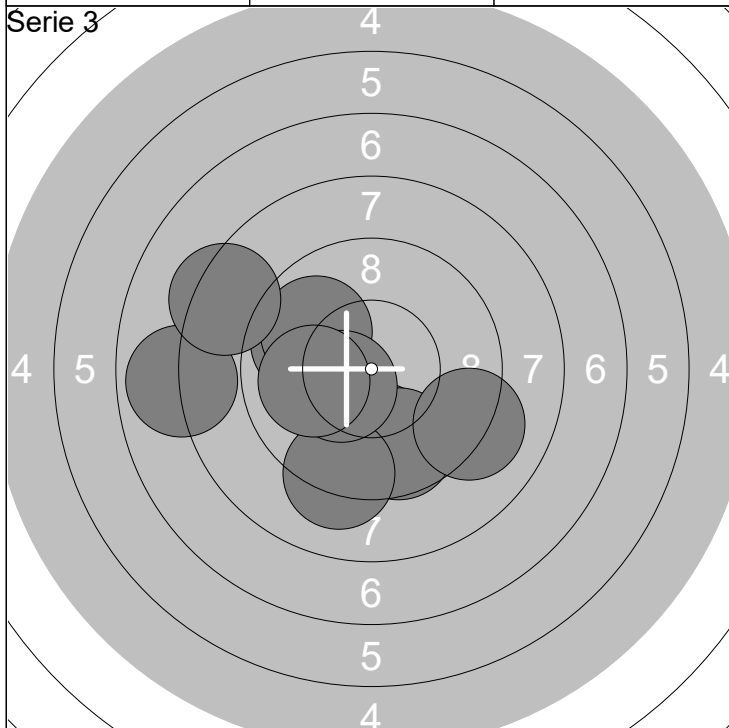

21: 9.8 ↖	26: 10.4x ↖	Serie	94.3
22: 9.9 ↗	27: 7.9 ↖		
23: 9.8 ↘	28: 8.4 ↖	Total	278.1
24: 9.7 ↘	29: 10.0 ↖		
25: 9.2 ↘	30: 9.2 ↘		

31: 9.5 ↗	36: 9.3 ↘	Serie	96.3
32: 8.7 ↘	37: 10.3x ↖		
33: 10.3x ↘	38: 9.7 ↗	Total	374.4
34: 9.3 ↖	39: 10.1 ↖		
35: 8.6 ↗	40: 10.5x ↖		

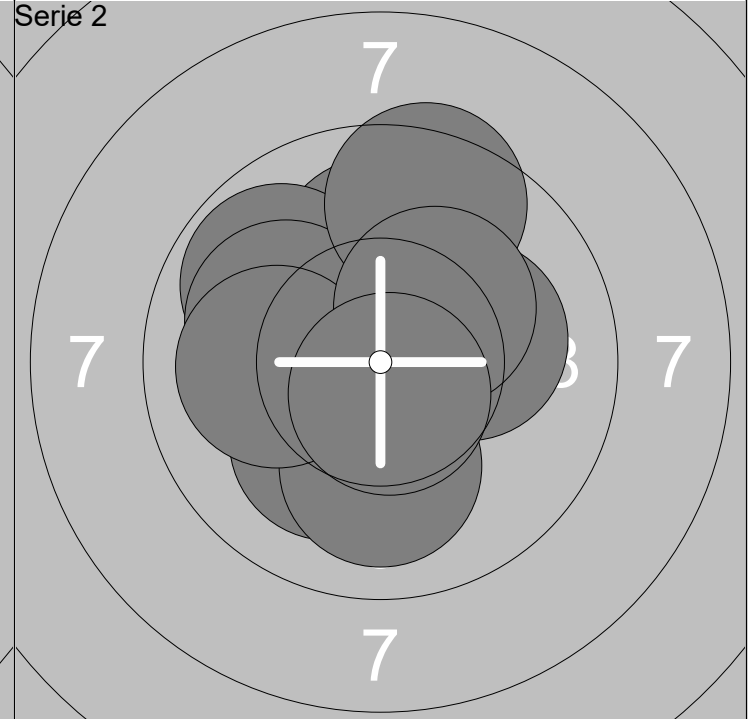
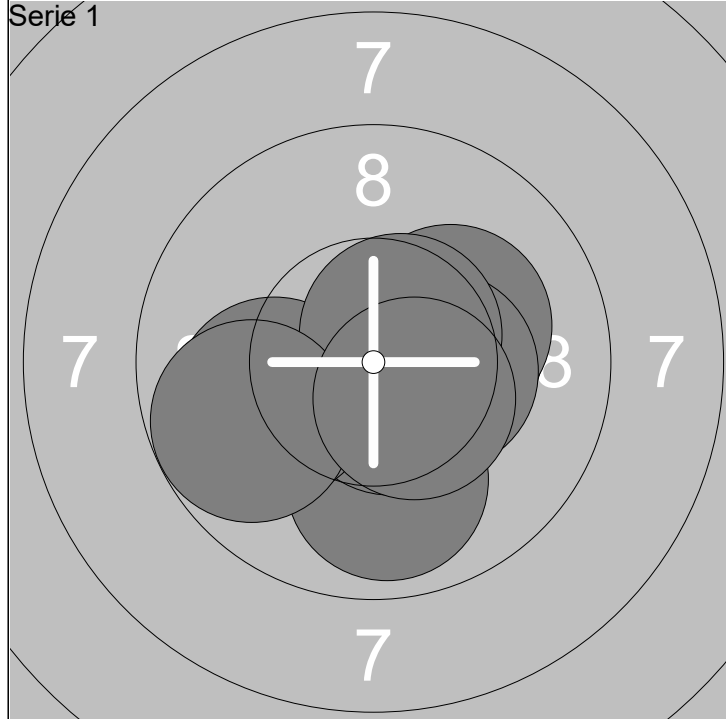

1: 10.4x →	6: 10.0 ←	Serie	103.1
2: 9.9 ↓	7: 10.7x →		
3: 10.2x →	8: 10.6x ↗	Total	103.1
4: 10.6x ↓	9: 9.8 ←		
5: 10.4x →	10: 10.5x ↘		

11: 10.0 ↑	16: 10.0 ↓	Serie	100.6
12: 10.1 ↓	17: 10.0 ←		
13: 9.8 ↖	18: 10.2x →	Total	203.7
14: 10.0 ↖	19: 10.3x ↗		
15: 9.5 ↑	20: 10.7x ↓		

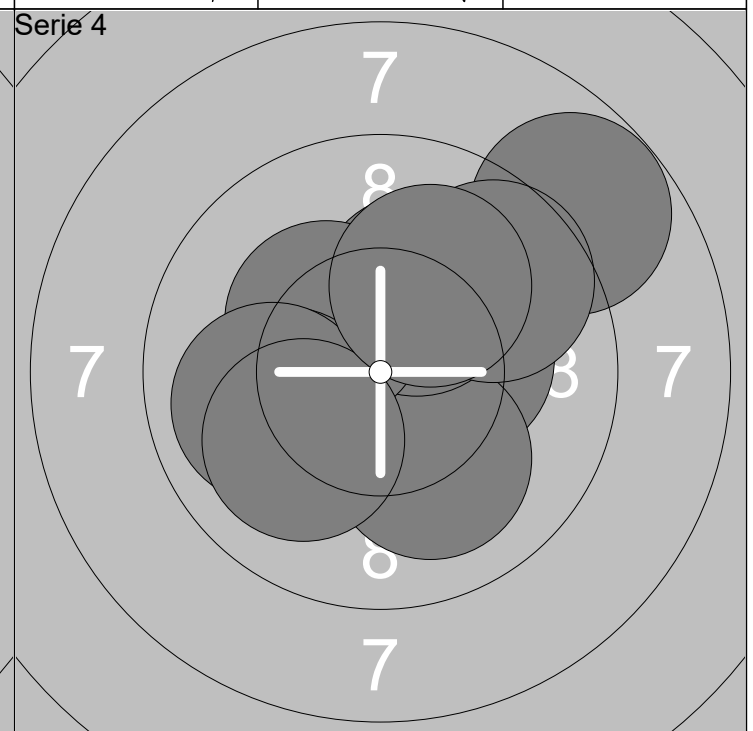
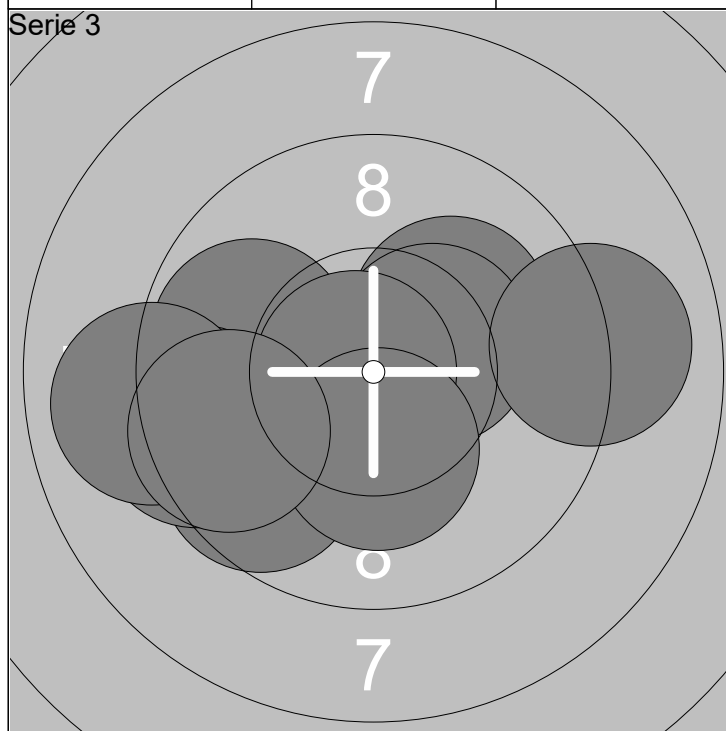

21: 9.6 ↖	26: 9.0 ←	Serie	97.9
22: 9.8 ←	27: 10.8x ←		
23: 10.1 ↗	28: 10.3x ↓	Total	301.6
24: 9.3 ←	29: 9.6 ←		
25: 10.4x →	30: 9.0 →		

31: 10.3x →	36: 10.3x ↖	Serie	99.4
32: 10.1 ↓	37: 10.0 ←		
33: 8.8 ↗	38: 9.9 ←	Total	401.0
34: 10.2x ↑	39: 10.0 ↖		
35: 9.7 ↗	40: 10.1 ↗		

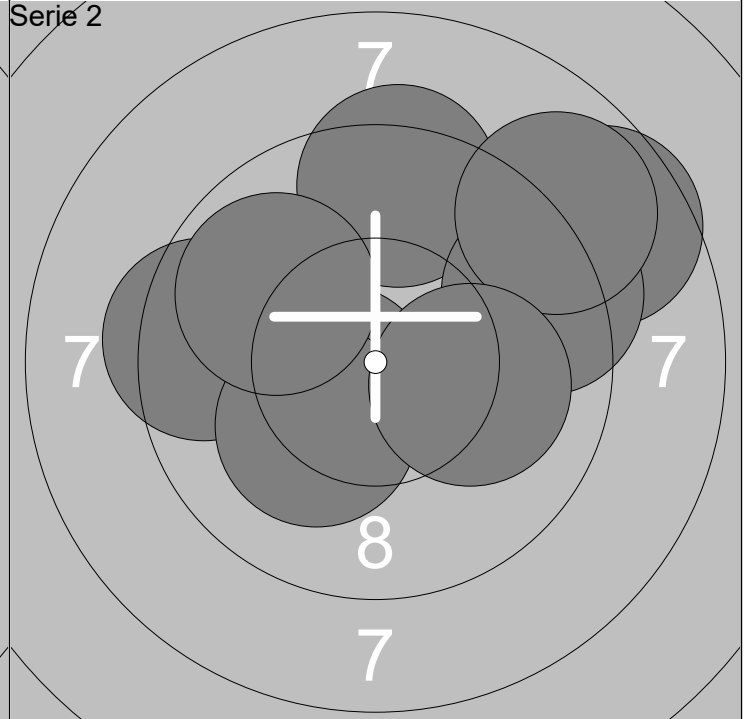
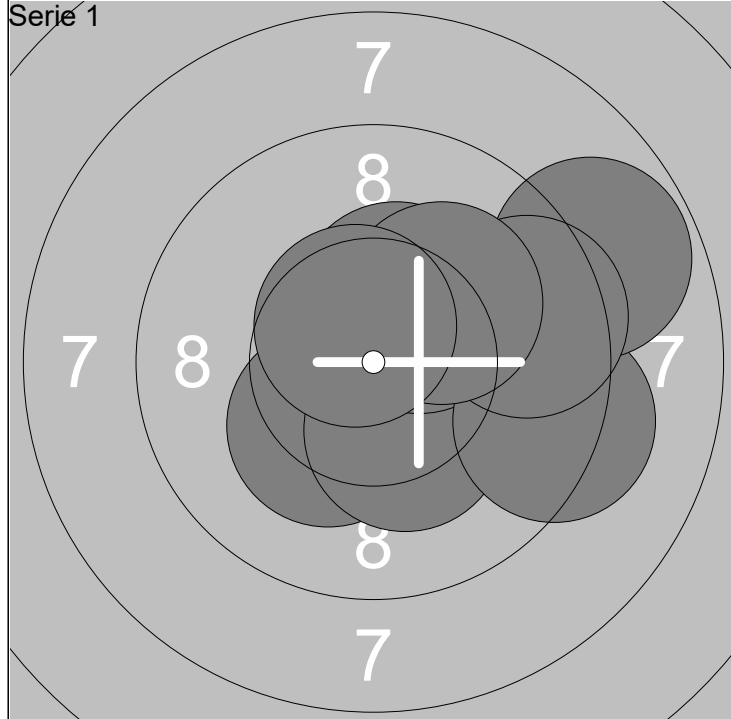

1: 10.2x →	6: 8.8 →	Serie	99.8
2: 10.2x ↙	7: 10.4x ↗		
3: 10.3x ↘	8: 9.5 →	Total	99.8
4: 10.3x ↗	9: 10.2x ↗		
5: 9.3 →	10: 10.6x ↖		

11: 9.4 ↑	16: 10.0 ↖	Serie	96.5
12: 8.6 →	17: 9.4 ←		
13: 9.4 →	18: 10.2x ↙	Total	196.3
14: 8.9 ↗	19: 10.1 →		
15: 10.6x ↙	20: 9.9 ↖		

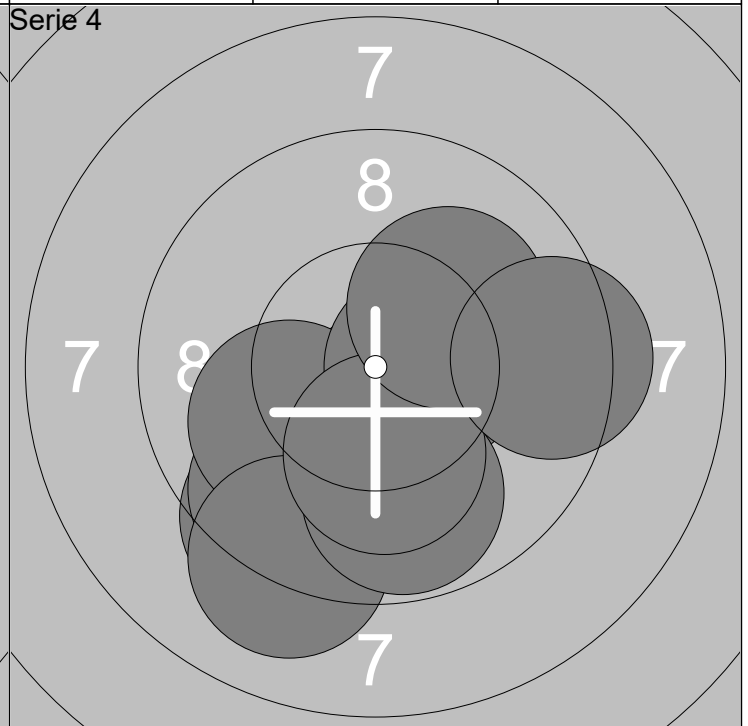
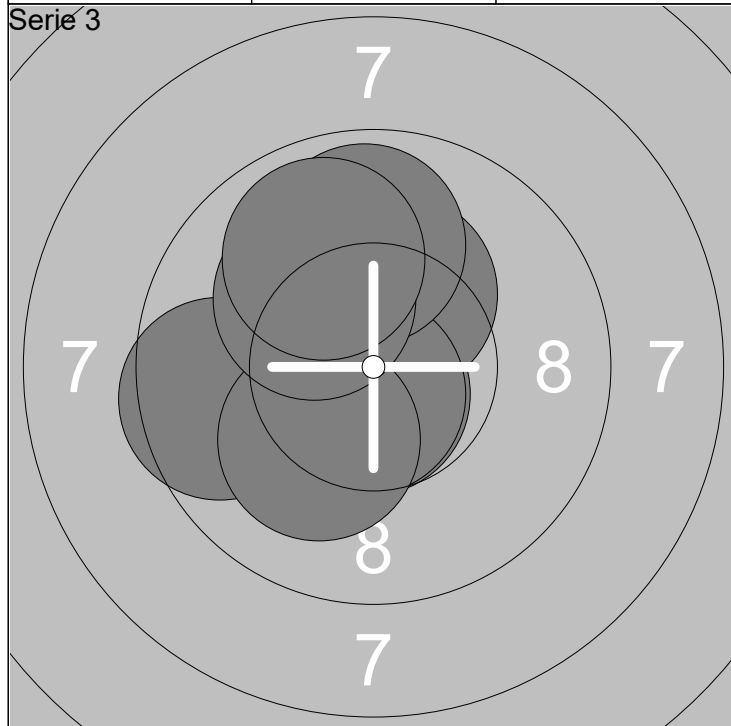

21: 10.4x ↙	26: 10.7x ↘	Serie	102.4
22: 10.6x ↖	27: 9.9 ↑		
23: 9.6 ←	28: 10.1 ↘	Total	298.7
24: 10.7x ↘	29: 10.2x ↖		
25: 10.3x ↗	30: 9.9 ↗		

31: 9.4 ↙	36: 10.5x →	Serie	98.6
32: 10.5x ↘	37: 9.8 ↘		
33: 9.6 ↙	38: 10.2x ↘	Total	397.3
34: 10.0 ↙	39: 10.1 ↗		
35: 9.1 ↘	40: 9.4 →		

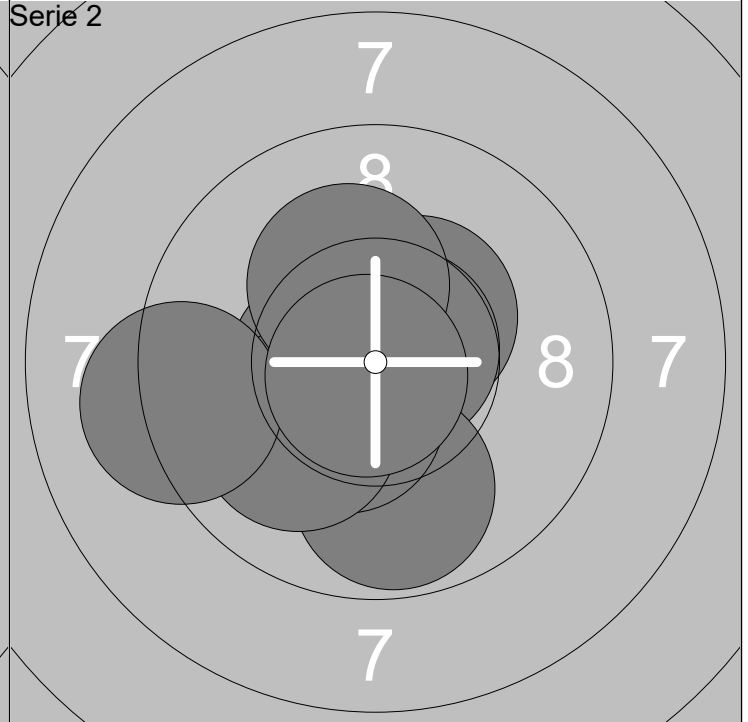
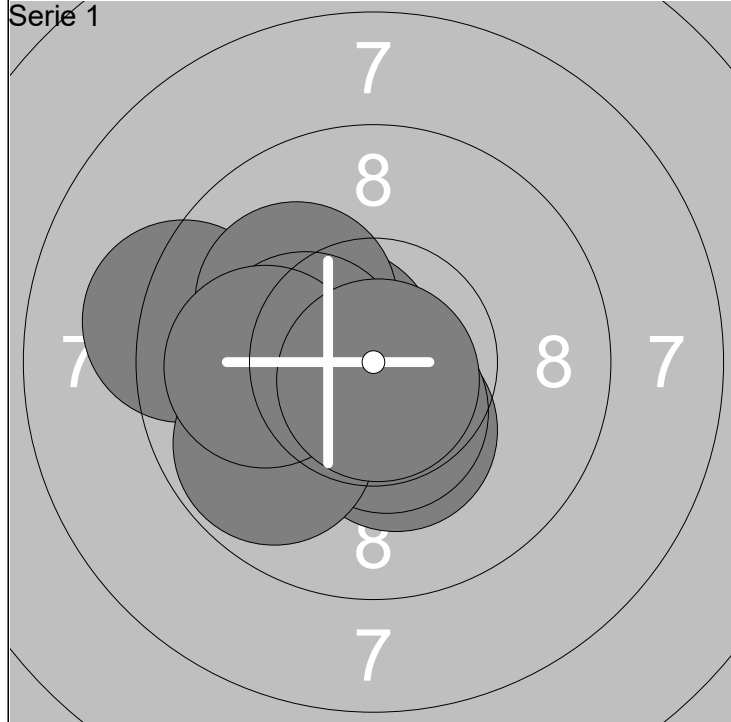

1: 10.5x ↙	6: 10.1 ↘	Serie 102.2
2: 10.6x ↙	7: 10.4x ↙	
3: 10.3x ↓	8: 9.8 ↙	Total 102.2
4: 9.2 ↙	9: 10.0 ↙	
5: 10.5x ↓	10: 10.8x ↓	

11: 10.4x ↘	16: 10.4x ↘	Serie 102.4
12: 10.4x ↗	17: 10.0 ↘	
13: 10.5x ↙	18: 9.2 ↙	Total 204.6
14: 10.7x ↗	19: 10.2x ↗	
15: 9.8 ↓	20: 10.8x ↘	

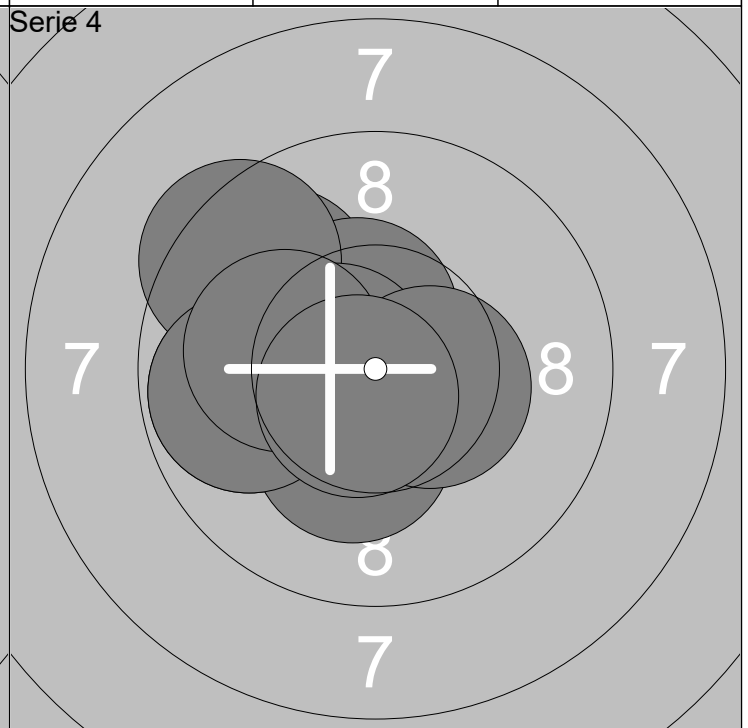
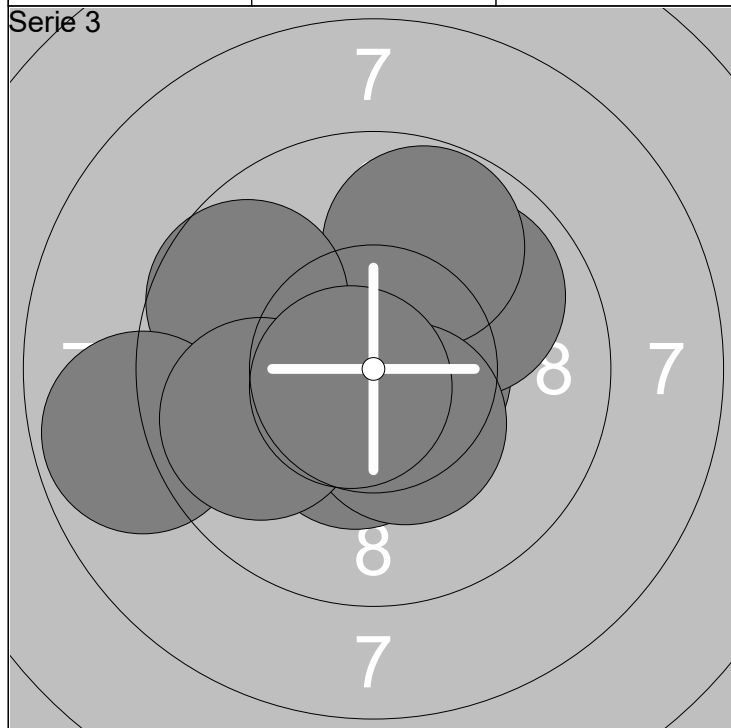

21: 10.6x →	26: 9.7 ↙	Serie 100.3
22: 10.4x ↓	27: 8.8 ↙	
23: 9.9 ↗	28: 10.4x ↓	Total 304.9
24: 9.8 ↗	29: 9.9 ↙	
25: 10.1 ↙	30: 10.7x ↙	

31: 9.8 ↙	36: 10.6x ↙	Serie 101.4
32: 9.8 ↙	37: 9.8 ↙	
33: 10.3x ↓	38: 10.1 ↙	Total 406.3
34: 10.5x ↗	39: 10.4x →	
35: 9.4 ↙	40: 10.7x ↘	

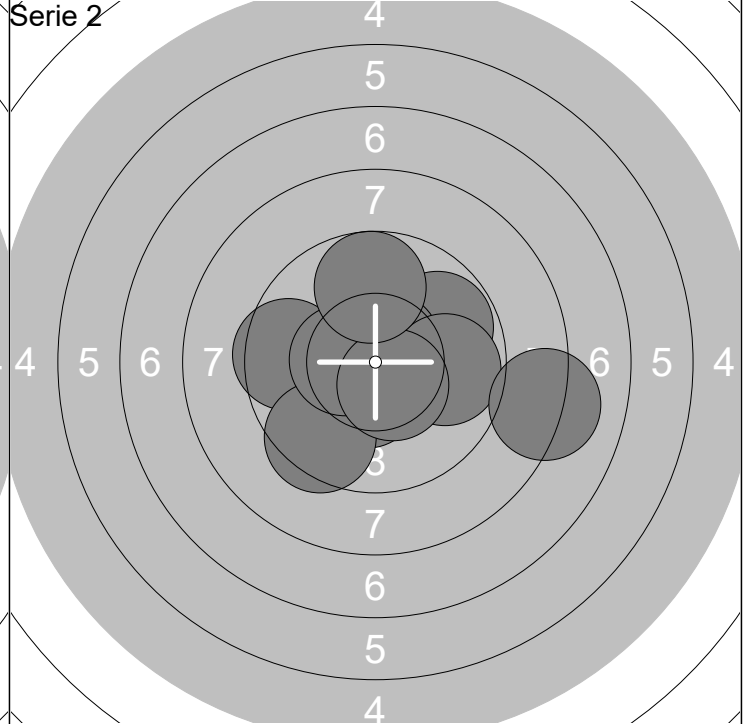
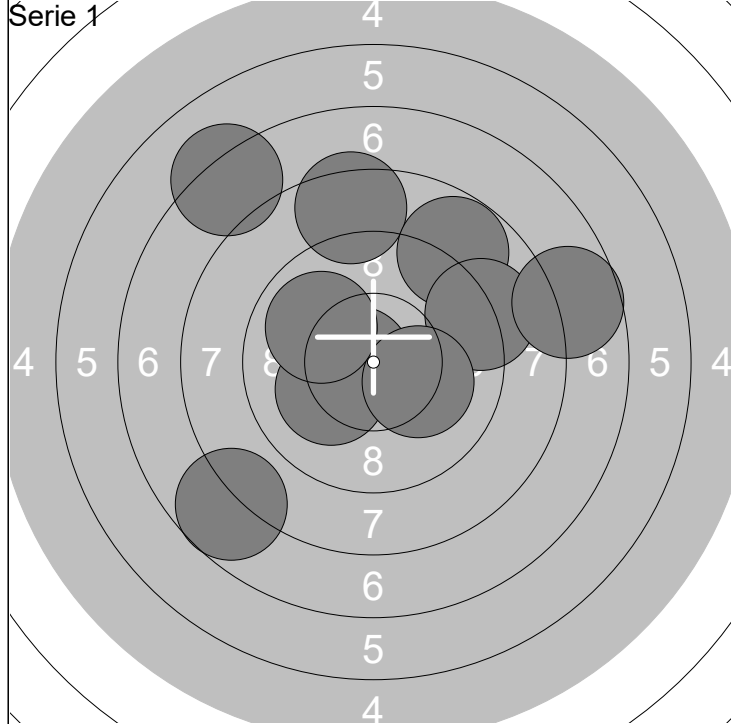

1: 7.2 ↖	6: 7.7 ↙	Serie	90.1
2: 8.5 ↑	7: 10.2x ↙		
3: 8.8 ↗	8: 10.2x →	Total	90.1
4: 10.7x ←	9: 10.0 ↖		
5: 9.1 →	10: 7.7 →		

11: 9.8 ↗	16: 9.5 ↙	Serie	98.8
12: 10.5x ↓	17: 10.5x ←		
13: 10.7x ↗	18: 10.5x ↙	Total	188.9
14: 9.5 ←	19: 9.8 ↑		
15: 9.8 →	20: 8.2 →		

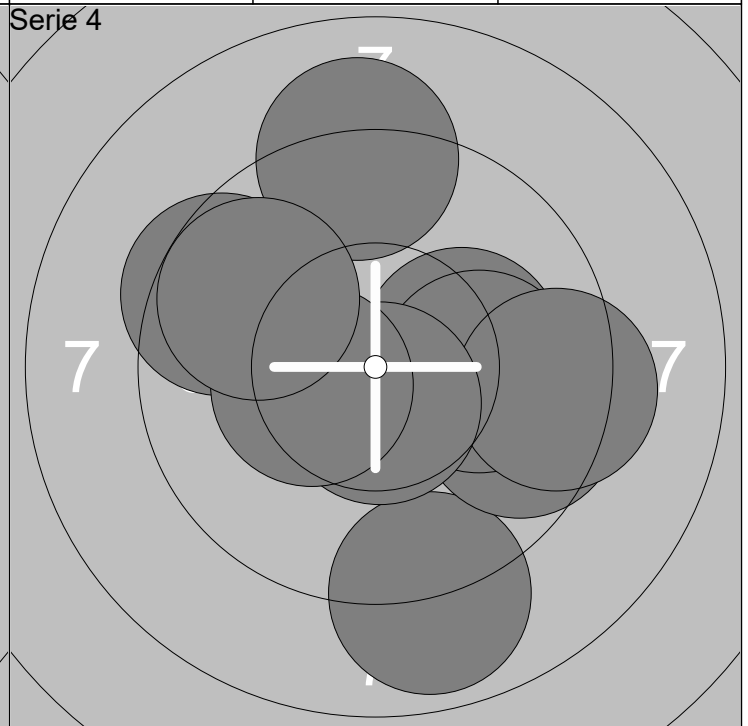
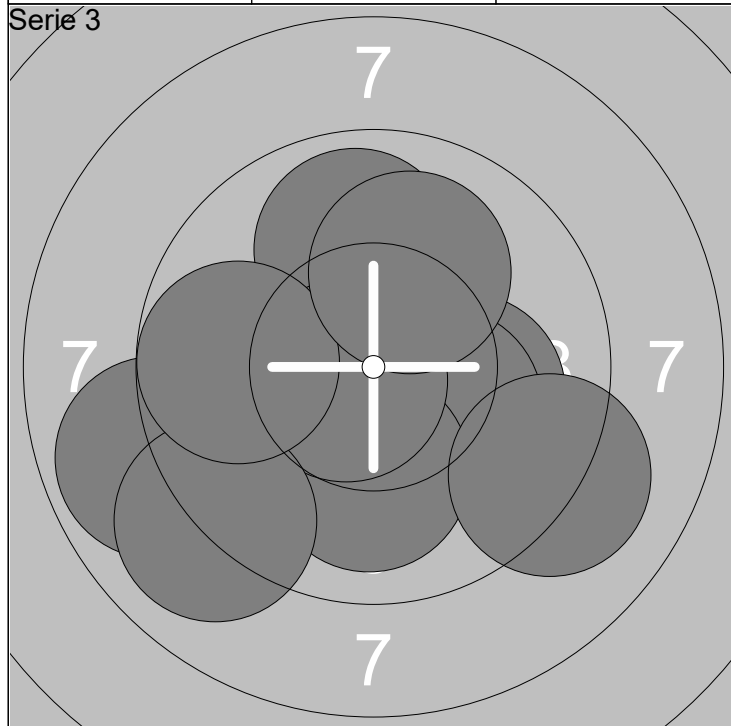

21: 9.9 ↑	26: 9.1 →	Serie	97.8
22: 10.1 →	27: 10.7x ↙		
23: 8.9 ←	28: 9.0 ↙	Total	286.7
24: 10.2x →	29: 9.8 ←		
25: 10.0 ↓	30: 10.1 ↗		

31: 9.1 ↑	36: 10.0 →	Serie	97.3
32: 8.9 ↓	37: 9.3 →		
33: 9.6 →	38: 10.6x ↓	Total	384.0
34: 9.5 ←	39: 10.4x ←		
35: 10.2x →	40: 9.7 ↖		



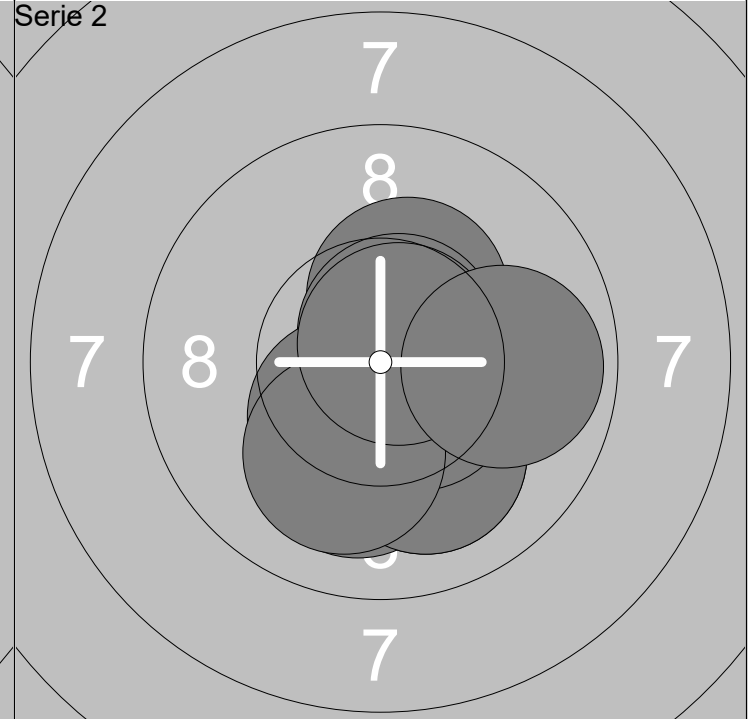
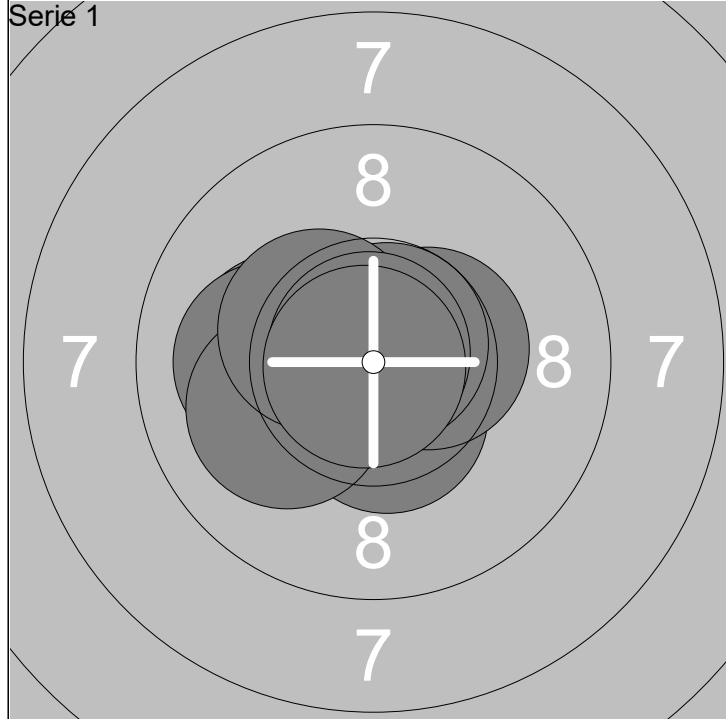

1: 10.2x ←	6: 10.8x ↗	Serie	105.0
2: 10.5x ↓	7: 10.1 ←		
3: 10.1 ←	8: 10.4x ↖	Total	105.0
4: 10.5x →	9: 10.9x ↗		
5: 10.7x ←	10: 10.8x ↖		

11: 10.4x ↗	16: 10.1 ↓	Serie	103.0
12: 10.0 ↓	17: 10.6x ↓		
13: 10.1 ↓	18: 10.1 ↓	Total	208.0
14: 10.7x ↗	19: 10.7x ↗		
15: 10.4x ↓	20: 9.9 →		

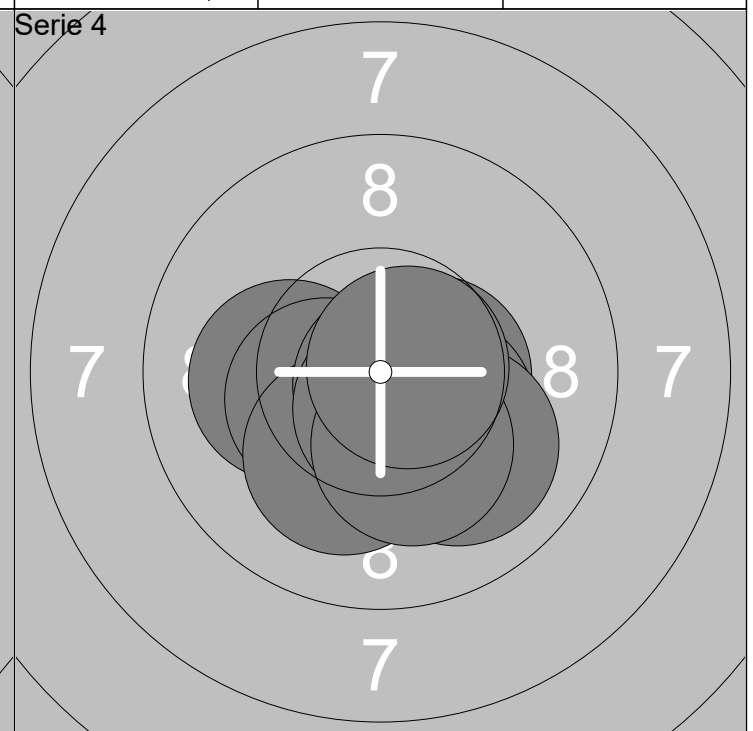
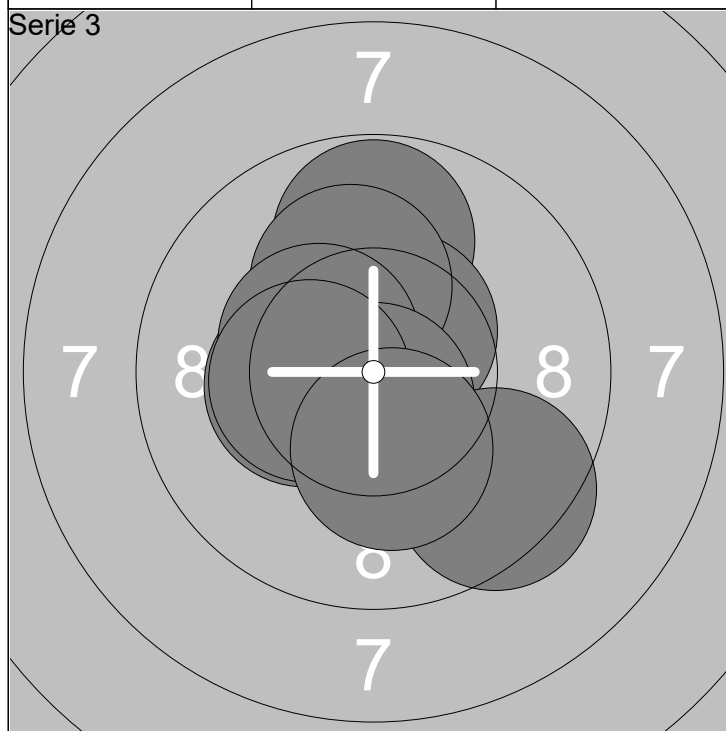

21: 10.7x ↗	26: 10.4x ↖	Serie	102.8
22: 9.8 ↑	27: 10.7x ↓		
23: 10.6x ↗	28: 9.5 ↓	Total	310.8
24: 10.2x ↑	29: 10.4x ←		
25: 10.3x ←	30: 10.2x ↓		

31: 10.1 ←	36: 10.8x ↓	Serie	103.9
32: 10.4x ↖	37: 10.6x ↓		
33: 10.2x ↓	38: 10.0 ↓	Total	414.7
34: 10.5x →	39: 10.2x ↓		
35: 10.4x ↓	40: 10.7x →		

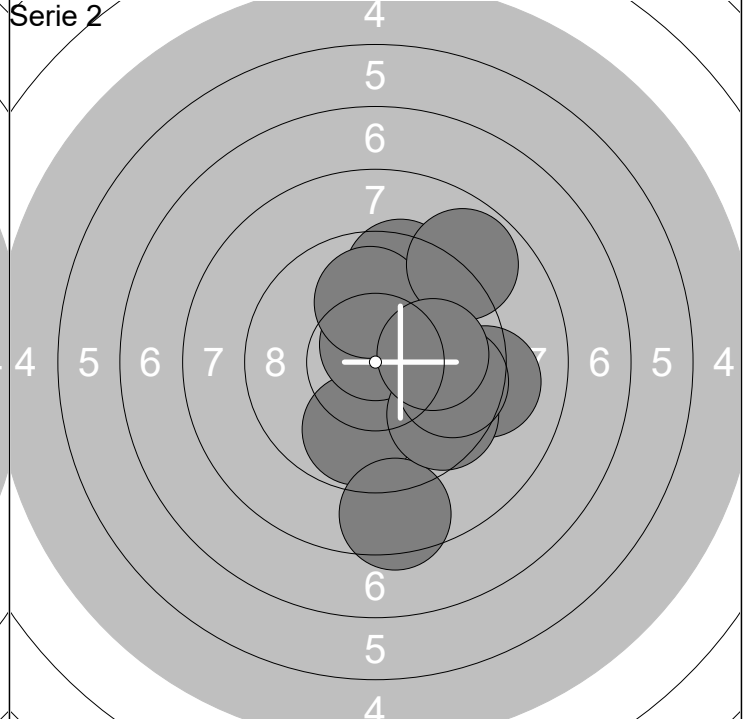
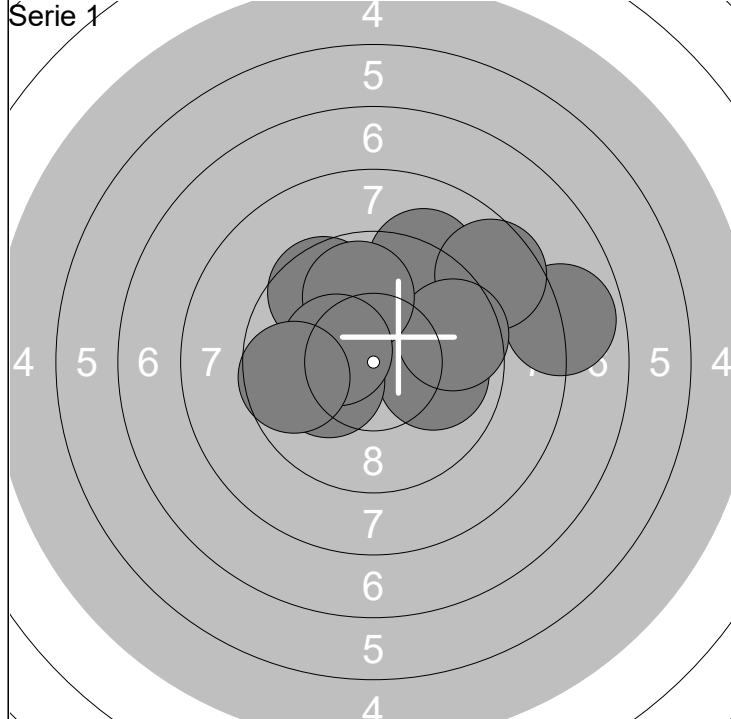

1: 9.2 ↗	6: 9.6 ↖	Serie	95.0
2: 7.9 →	7: 10.2x ←		
3: 10.0 →	8: 9.9 ↑	Total	95.0
4: 8.6 ↗	9: 10.3x ←		
5: 9.6 →	10: 9.7 ←		

11: 9.8 ↓	16: 9.6 ↘	Serie	95.9
12: 8.5 ↓	17: 9.7 →		
13: 9.5 ↑	18: 10.0 ↑	Total	190.9
14: 9.2 →	19: 8.9 ↗		
15: 10.7x ↑	20: 10.0 →		

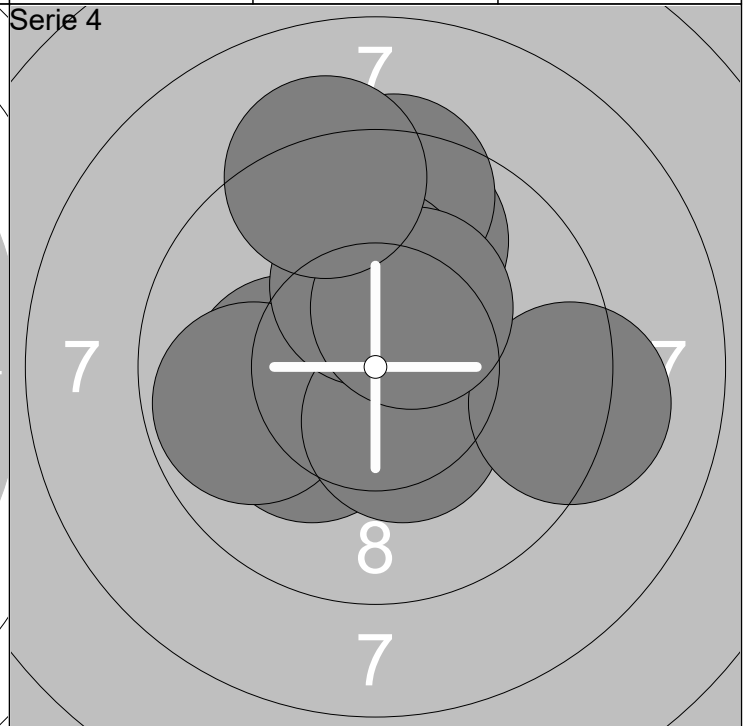
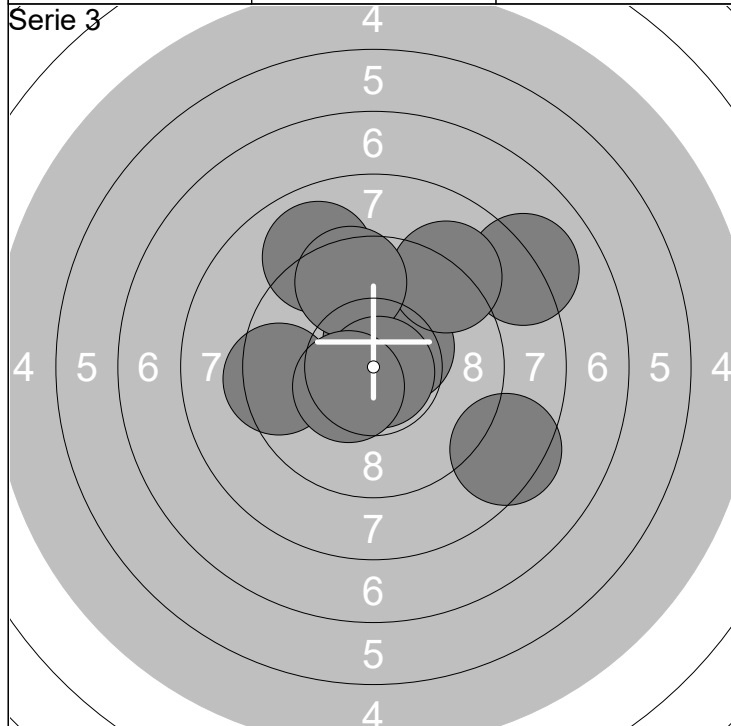

21: 10.6x ↑	26: 9.1 ↗	Serie	95.9
22: 10.4x ↗	27: 9.5 ↑		
23: 9.0 ↖	28: 9.4 ←	Total	286.8
24: 8.1 ↗	29: 10.9x ↘		
25: 8.5 ↘	30: 10.4x ↖		

31: 10.2x ↖	36: 10.4x ↘	Serie	98.7
32: 10.2x ←	37: 9.2 →		
33: 9.8 ↑	38: 10.2x ↑	Total	385.5
34: 9.4 ↑	39: 10.3x ↗		
35: 9.8 ←	40: 9.2 ↑		

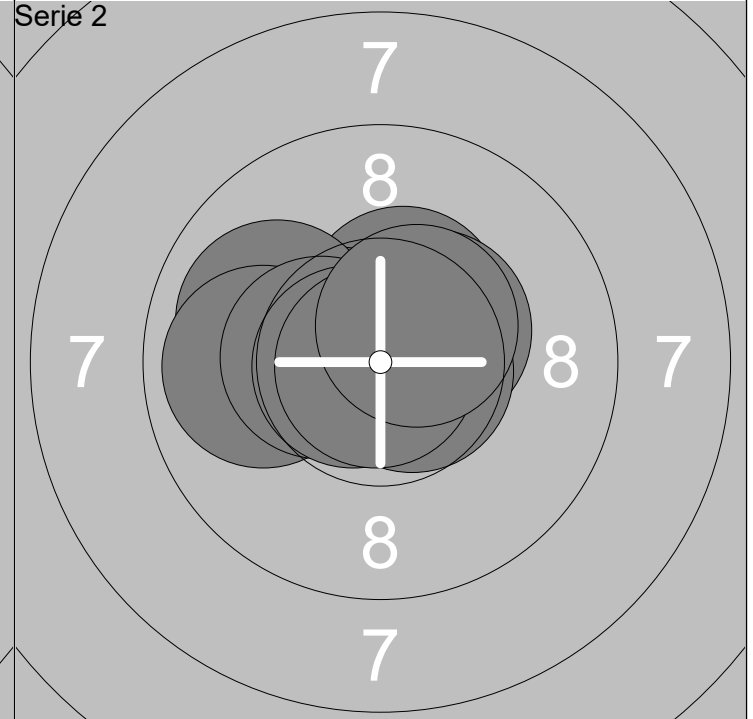
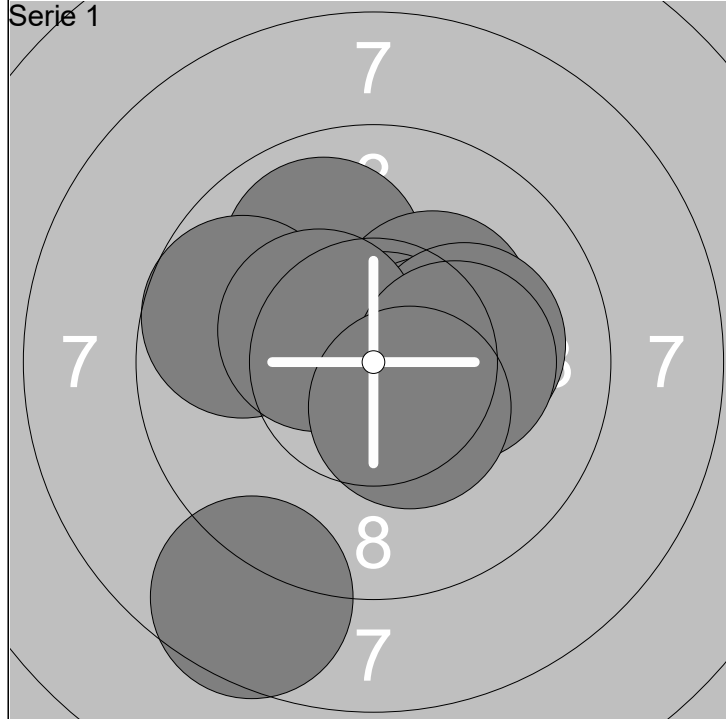

1: 9.9 ↗	6: 10.1 →	Serie	100.7
2: 9.7 ↖	7: 10.4x ↖		
3: 10.2x ↗	8: 10.2x →	Total	100.7
4: 10.8x ↗	9: 8.6 ↓		
5: 10.4x →	10: 10.4x ↓		

11: 10.4x ↗	16: 10.4x ←	Serie	104.5
12: 10.6x ↖	17: 10.7x →		
13: 10.0 ↖	18: 10.7x ←	Total	205.2
14: 9.9 ↖	19: 10.9x ↙		
15: 10.4x ↗	20: 10.5x ↗		

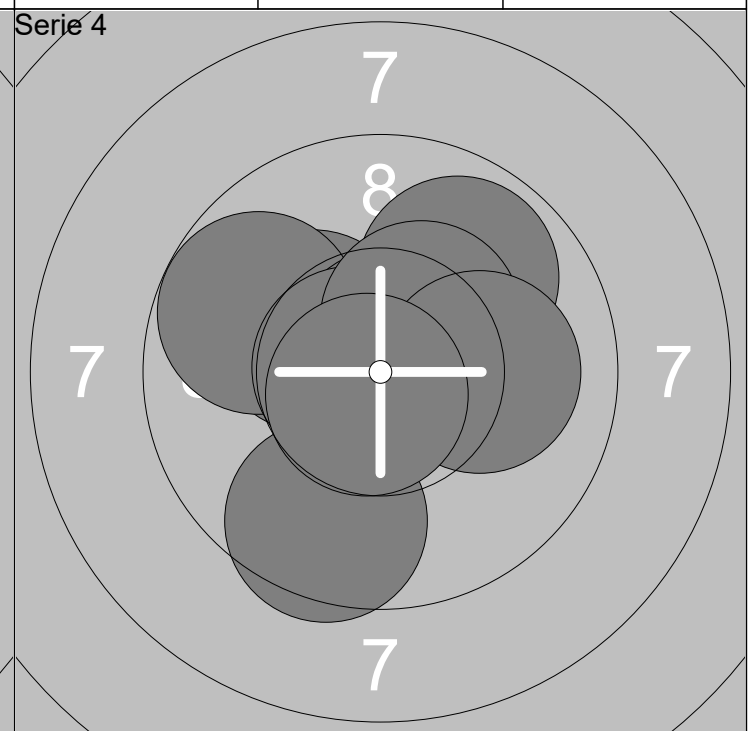
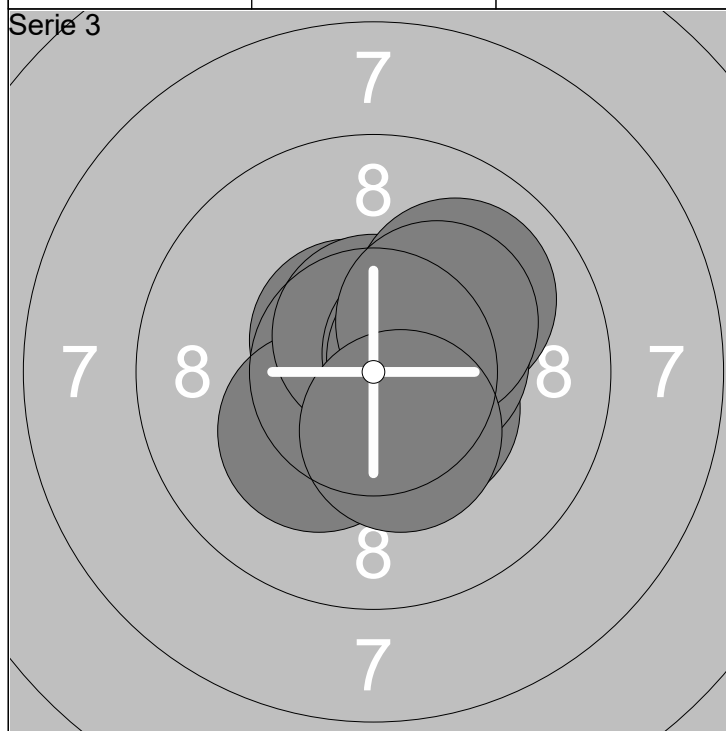

21: 10.5x ↓	26: 10.0 ↗	Serie	103.9
22: 10.4x ↘	27: 10.5x →		
23: 10.6x ↗	28: 10.5x →	Total	309.1
24: 10.2x ↙	29: 10.2x ↗		
25: 10.6x ↑	30: 10.4x ↓		

31: 9.9 ↗	36: 10.7x ←	Serie	102.3
32: 10.2x ↖	37: 10.4x ↗		
33: 9.8 ↖	38: 9.6 ↓	Total	411.4
34: 10.7x ↗	39: 10.0 →		
35: 10.3x →	40: 10.7x ↙		

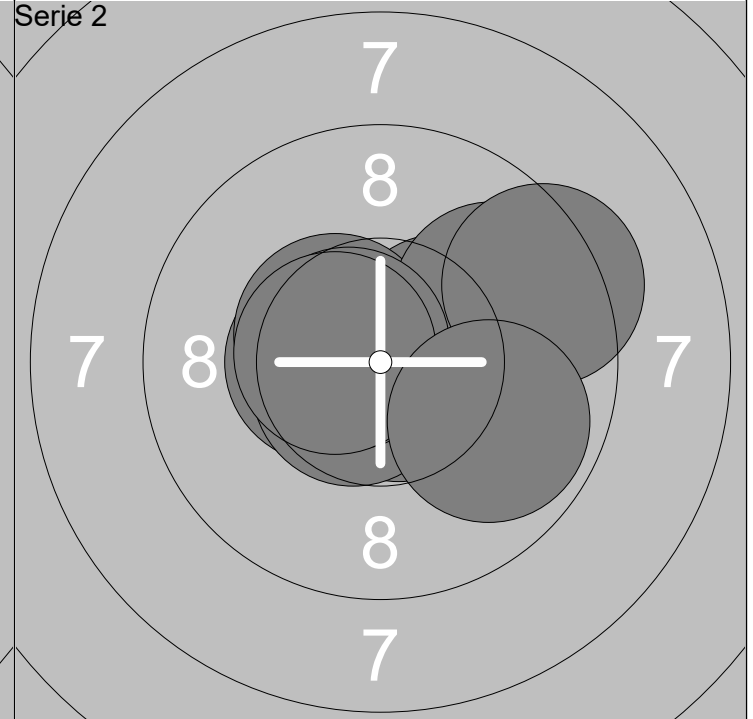
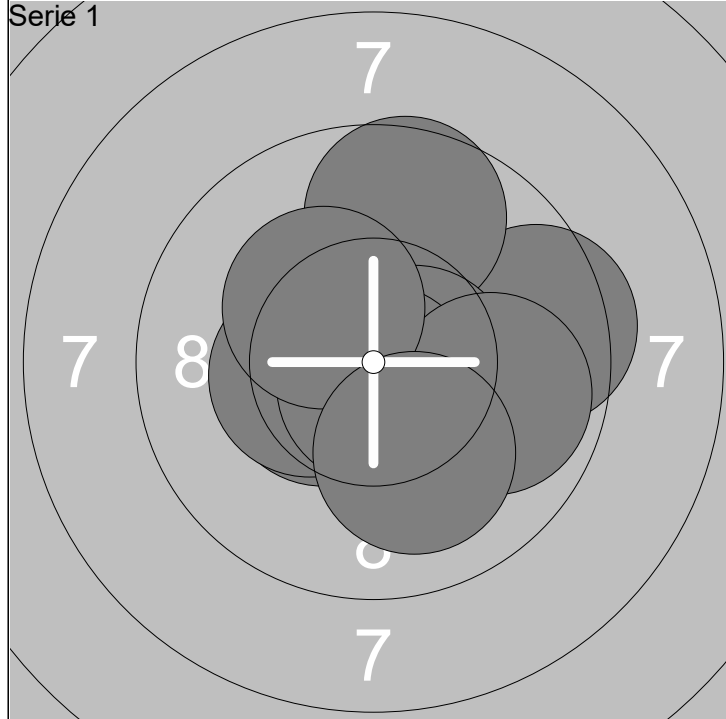

1: 10.5x ←	6: 10.2x ↓	Serie	101.8
2: 9.5 →	7: 10.7x ↓		
3: 10.4x ←	8: 9.9 →	Total	101.8
4: 9.6 ↑	9: 10.3x ↗		
5: 10.6x →	10: 10.1 ↓		

11: 10.3x →	16: 10.7x ↙	Serie	102.9
12: 10.5x ←	17: 10.7x ↙		
13: 10.5x ↖	18: 10.5x ←	Total	204.7
14: 10.7x ↓	19: 9.3 →		
15: 9.8 →	20: 9.9 ↓		

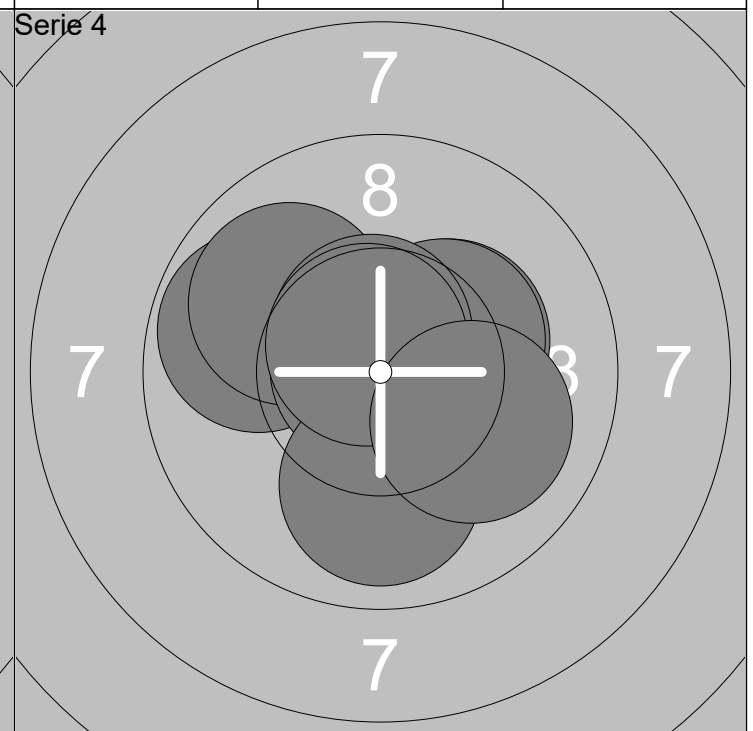
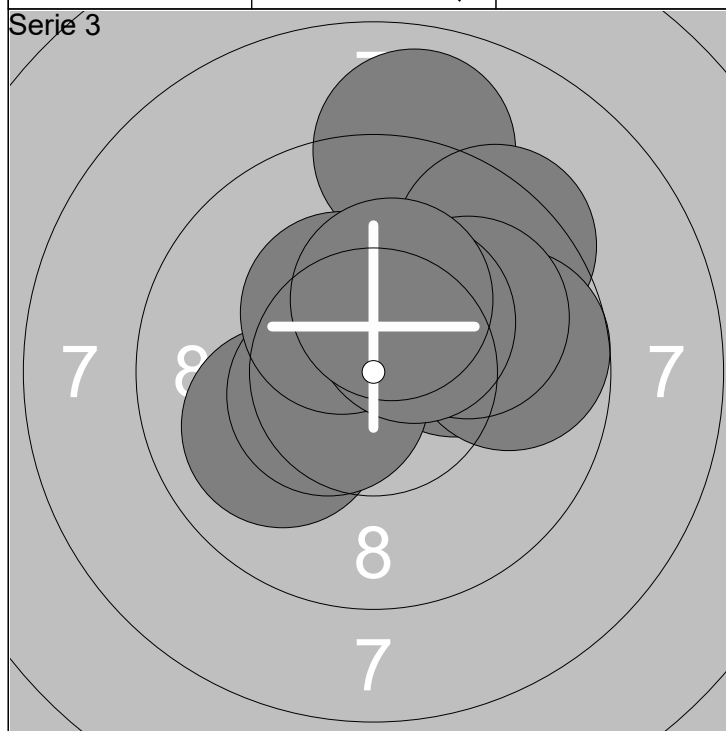

21: 10.2x →	26: 10.5x ←	Serie	99.7
22: 8.9 ↑	27: 10.3x ↖		
23: 9.4 ↗	28: 10.0 →	Total	304.4
24: 10.0 ←	29: 10.4x ↗		
25: 9.7 →	30: 10.3x ↑		

31: 9.8 ←	36: 10.3x →	Serie	102.9
32: 10.0 ↖	37: 10.0 ↓		
33: 10.9x ↖	38: 10.6x ↑	Total	407.3
34: 10.3x →	39: 10.7x ↗		
35: 10.3x →	40: 10.0 ↓		

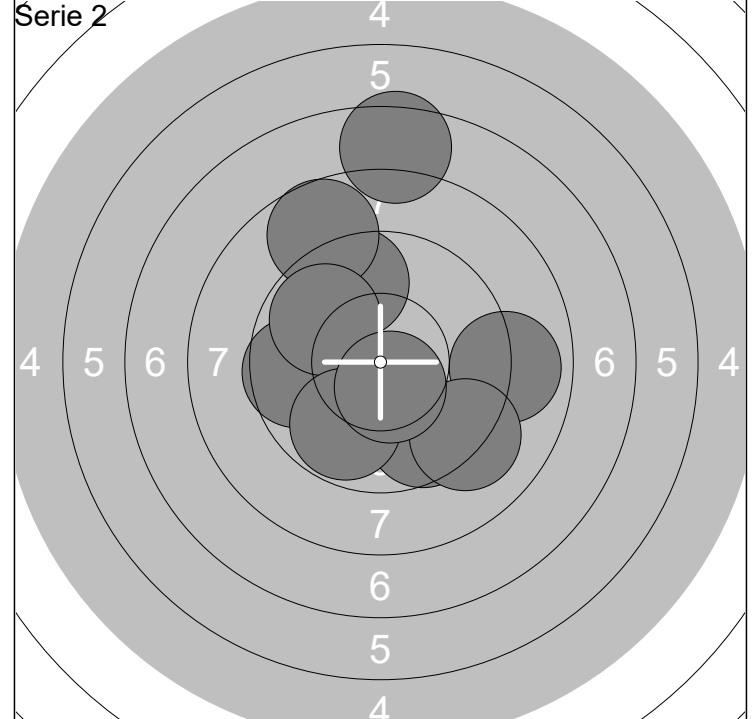
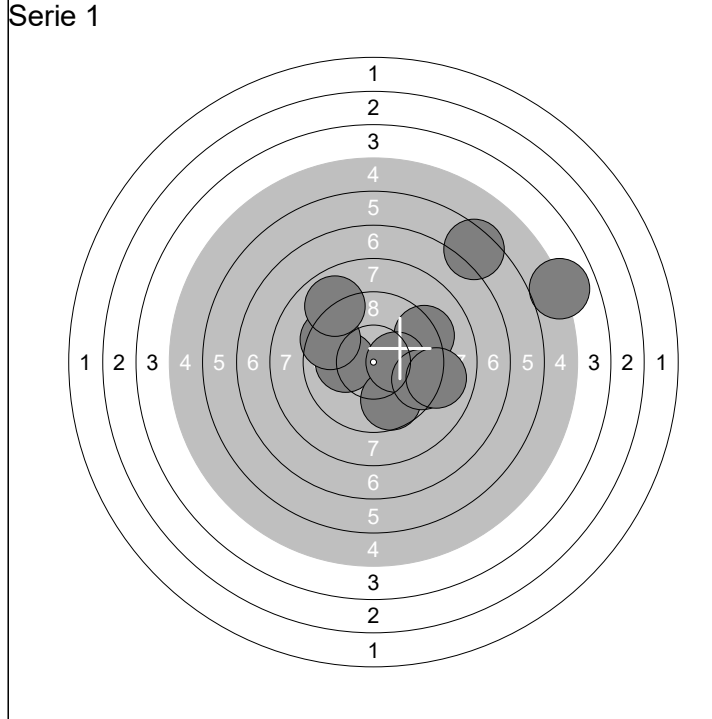

1: 10.1 ←	6: 9.7 ↘		Serie	87.6	11: 9.6 ↘	16: 9.8 ↗		Serie	93.3
2: 9.5 ↖	7: 10.3x →				12: 7.5 ↑	17: 9.0 →			
3: 9.2 ↗	8: 9.4 ↘	Total	87.6	13: 9.6 ↑	18: 9.8 ↘	Total	180.9		
4: 6.5 ↗	9: 9.0 ↘			14: 9.6 ←	19: 9.2 ↘				
5: 5.0 ↗	10: 8.9 ↗			15: 8.7 ↗	20: 10.5x ↘				

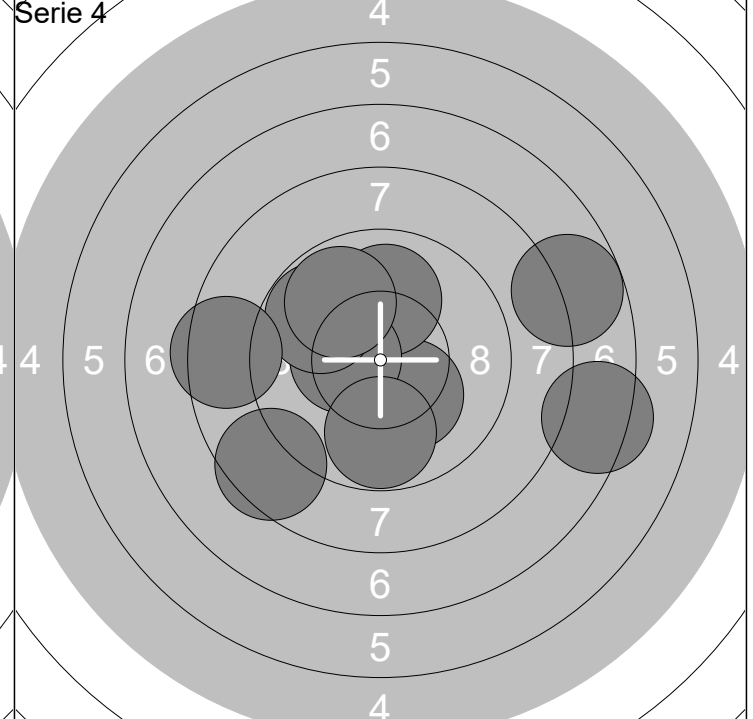
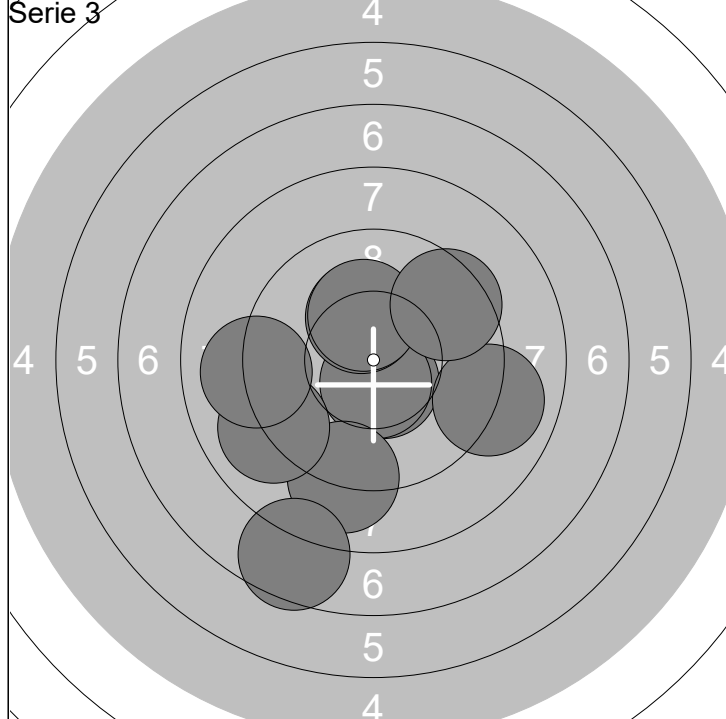

21: 10.6x ↘	26: 10.2x ↑		Serie	94.7	31: 10.3x ↘	36: 9.8 ↘		Serie	92.3
22: 10.6x ↘	27: 9.0 →				32: 7.4 →	37: 9.9 ↗			
23: 10.2x ↑	28: 9.5 ↗	Total	275.6	33: 10.0 ↑	38: 7.7 →	Total	367.9		
24: 9.0 ↘	29: 9.0 ←			34: 10.4x ←	39: 8.5 ←				
25: 7.6 ↘	30: 9.0 ←			35: 9.8 ↗	40: 8.5 ↘				

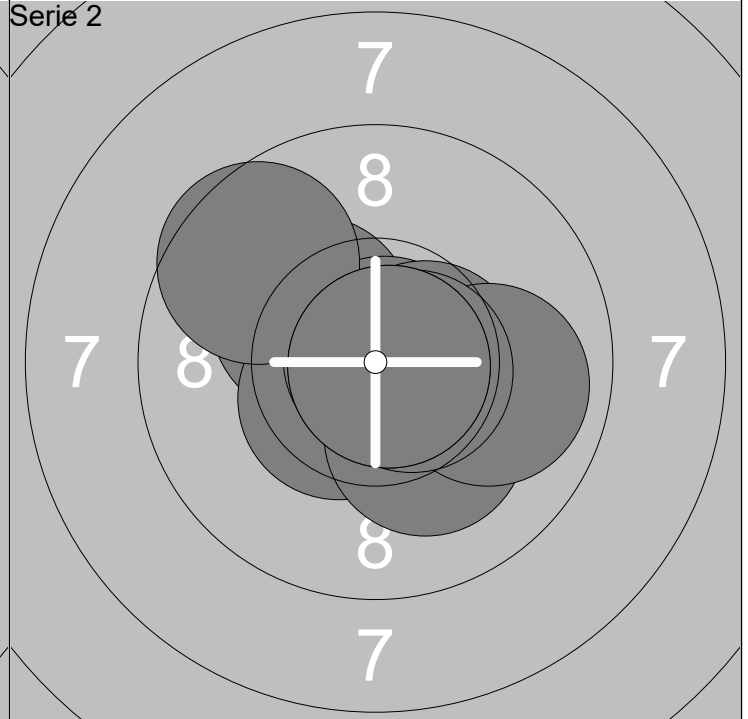
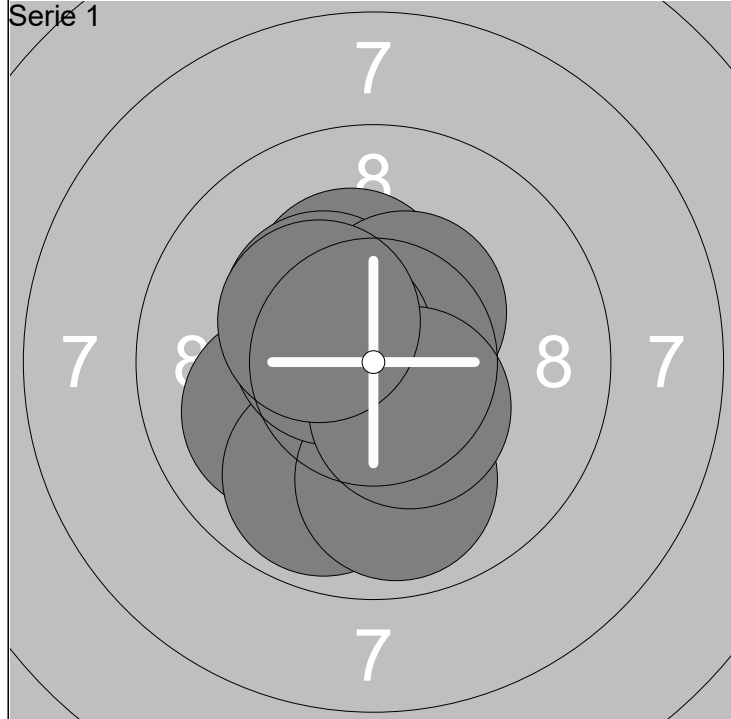

1: 10.0 ↙	6: 10.3x ↗	Serie	102.9
2: 9.9 ↘	7: 10.4x ↗		
3: 10.3x ↗	8: 10.5x ↙	Total	102.9
4: 10.8x →	9: 10.4x ↘		
5: 9.9 ↘	10: 10.4x ↙		

11: 10.3x ↗	16: 9.9 →	Serie	104.1
12: 10.5x ↘	17: 10.6x →		
13: 10.2x ↘	18: 9.6 ↗	Total	207.0
14: 10.9x ↗	19: 10.8x →		
15: 10.5x →	20: 10.8x →		

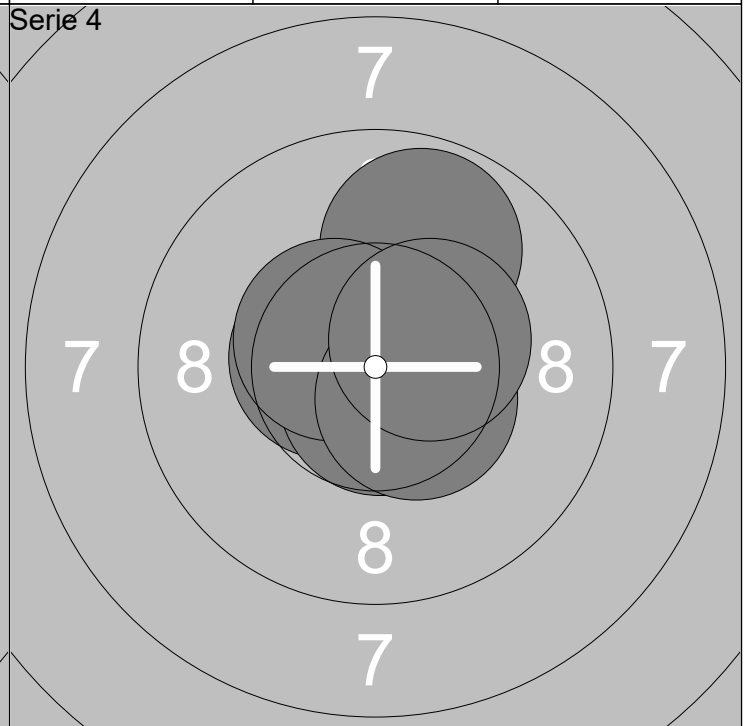
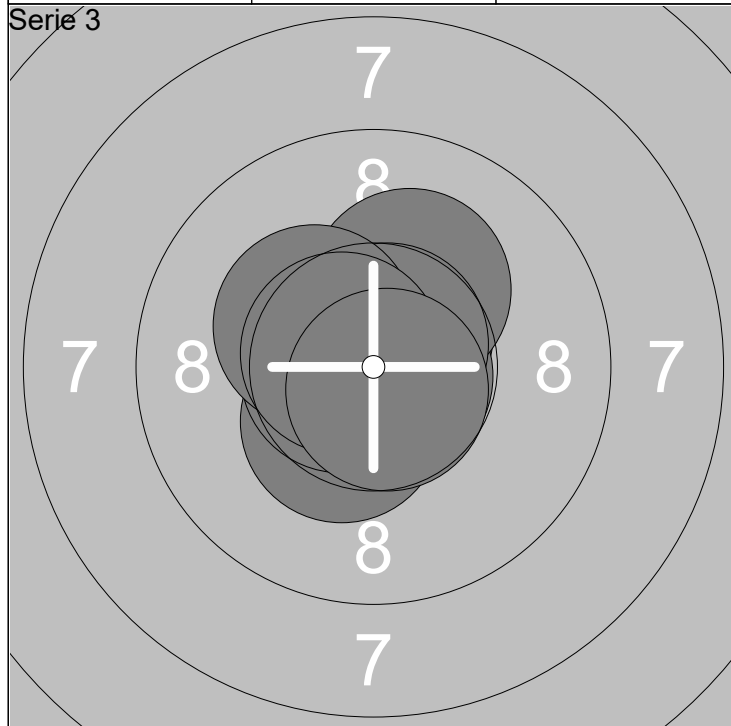

21: 10.8x ↗	26: 10.4x ↘	Serie	105.7
22: 10.6x ↗	27: 10.6x ←		
23: 10.8x →	28: 10.3x ↗	Total	312.7
24: 10.2x ↗	29: 10.6x ↙		
25: 10.7x ↗	30: 10.7x ↘		

31: 10.6x ↗	36: 10.6x →	Serie	105.1
32: 10.5x ←	37: 9.8 ↗		
33: 10.8x →	38: 10.5x ↙	Total	417.8
34: 10.7x ↗	39: 10.5x ↘		
35: 10.7x ↘	40: 10.4x →		

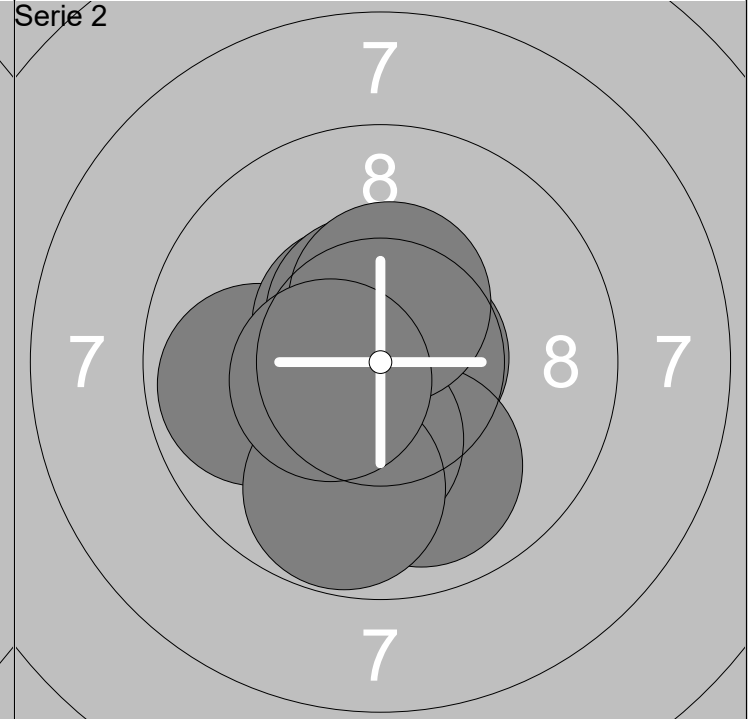
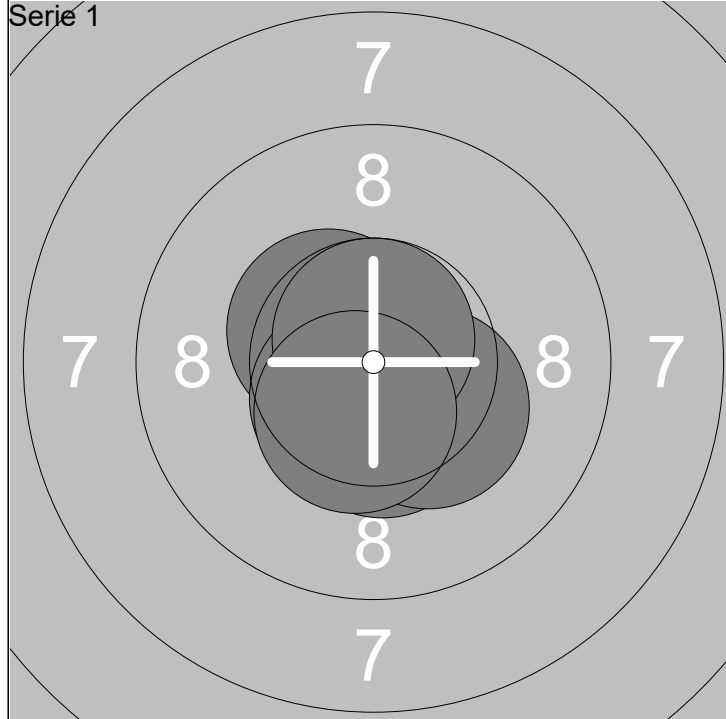

1: 10.8x ←	6: 10.5x ↖	Serie 106.4
2: 10.9x ↗	7: 10.3x ↘	
3: 10.5x ↓	8: 10.6x ↙	Total 106.4
4: 10.8x ↑	9: 10.8x ↑	
5: 10.7x ←	10: 10.5x ↓	

11: 10.7x →	16: 9.8 ↓	Serie 103.3
12: 9.9 ←	17: 10.5x ↗	
13: 10.7x ←	18: 10.5x ↑	Total 209.7
14: 10.0 ↓	19: 10.4x ↑	
15: 10.3x ↓	20: 10.5x ←	

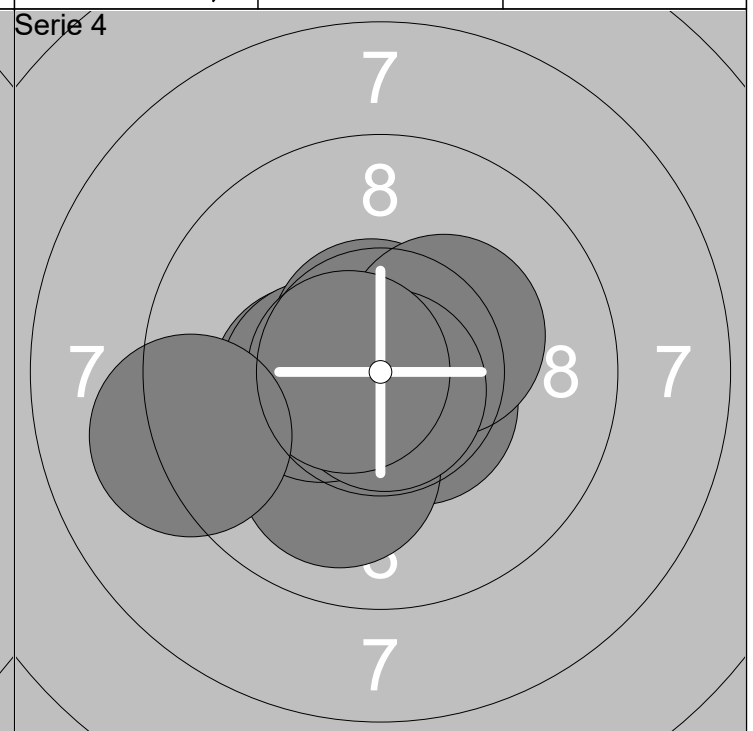
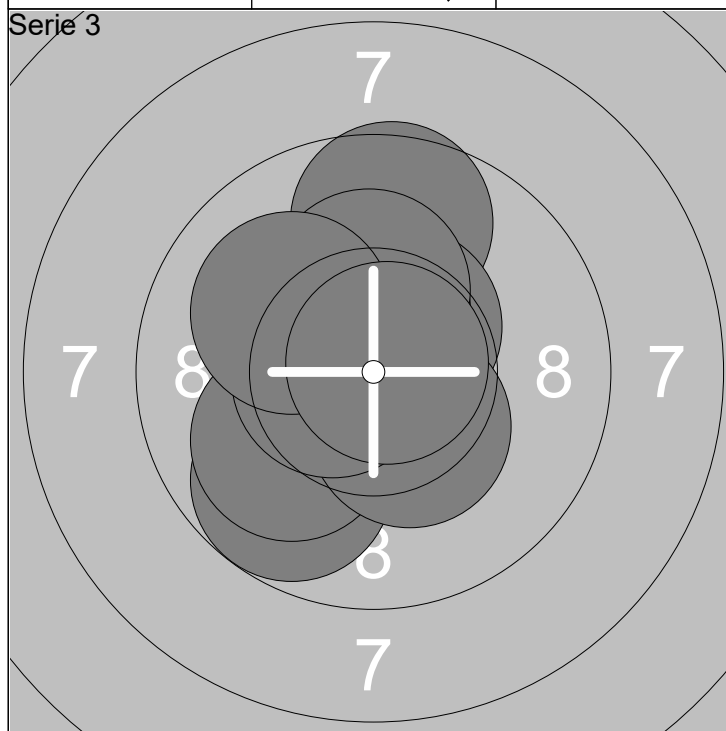

21: 9.6 ↑	26: 10.0 ←	Serie 102.4
22: 10.5x ↗	27: 10.4x ↘	
23: 10.4x ↑	28: 10.6x ←	Total 312.1
24: 10.2x ↑	29: 10.1 ↖	
25: 9.8 ↙	30: 10.8x ↗	

31: 10.3x ←	36: 10.6x ↑	Serie 103.6
32: 10.8x ↑	37: 10.3x ↗	
33: 10.5x ↘	38: 10.8x ↓	Total 415.7
34: 10.0 ↓	39: 10.7x ←	
35: 10.4x ←	40: 9.2 ←	

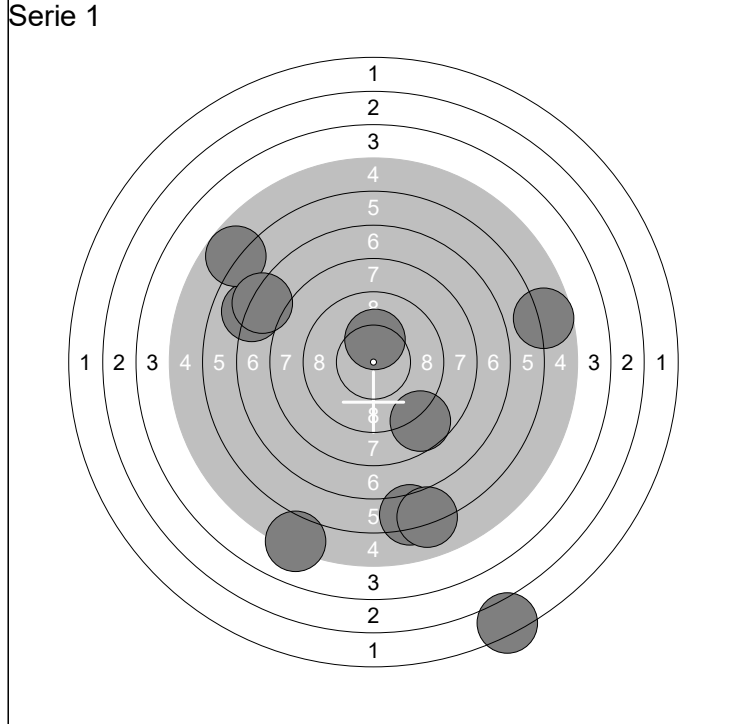

1: 5.1 ↘	6: 5.7 →	Serie	64.4
2: 2.2 ↘	7: 5.8 ↗		
3: 7.0 ↖	8: 7.2 ↗	Total	64.4
4: 10.3x ↑	9: 6.1 ↘		
5: 6.3 ↘	10: 8.7 ↘		

11: 6.8 ↙	16: 9.0 ←	Serie	49.5
12: 1.4 ↓	17: 0.0 ←		
13: 3.1 ↑	18: 4.3 ←	Total	113.9
14: 6.4 ↙	19: 9.7 →		
15: 8.8 →	20: 0.0 ←		

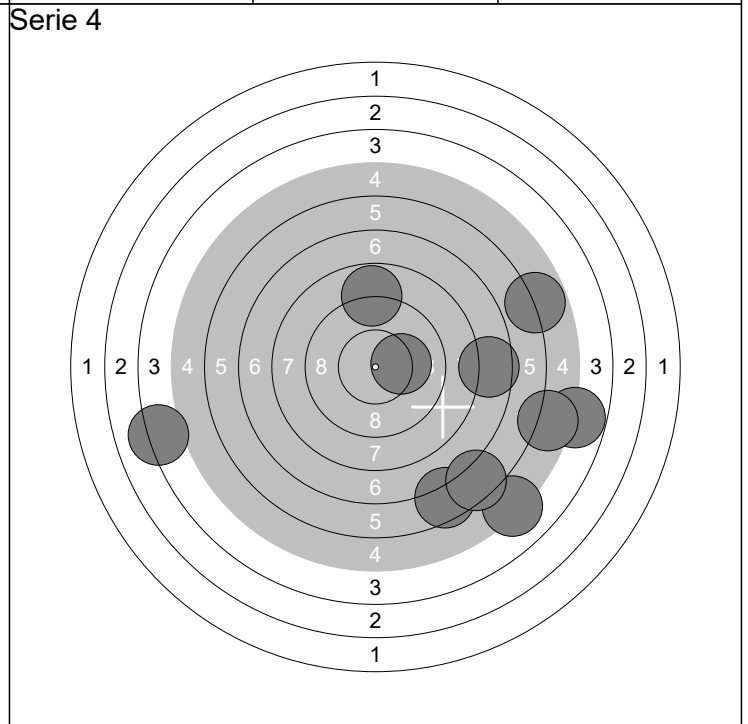
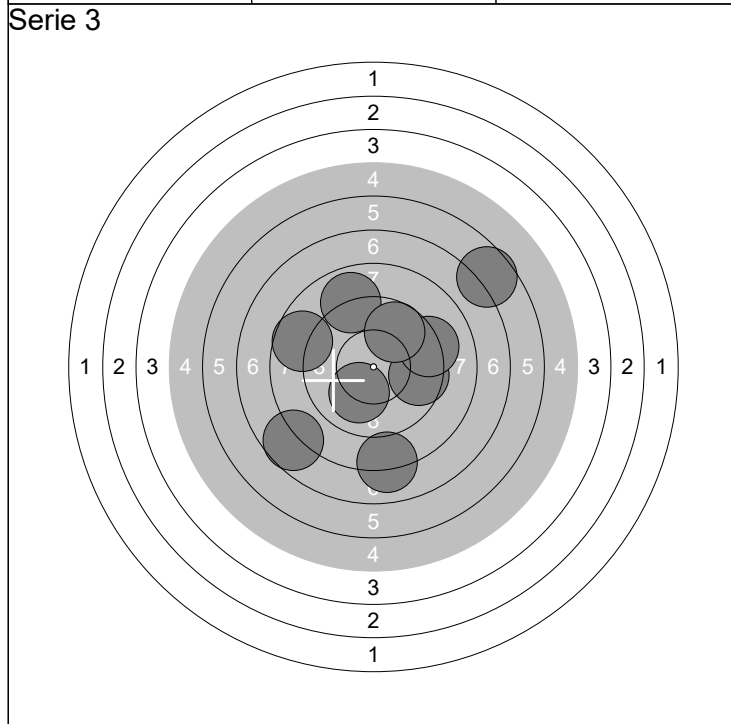

21: 0.0 ←	26: 8.7 ←	Serie	78.6
22: 8.9 ↑	27: 6.6 ↗		
23: 7.7 ↙	28: 9.7 ↗	Total	192.5
24: 9.6 →	29: 10.1 ↘		
25: 9.2 →	30: 8.1 ↓		

31: 5.1 ↘	36: 10.2x →	Serie	64.8
32: 8.8 ↑	37: 4.8 →		
33: 6.5 ↘	38: 5.6 →	Total	257.3
34: 7.5 →	39: 5.8 →		
35: 4.1 ←	40: 6.4 ↘		



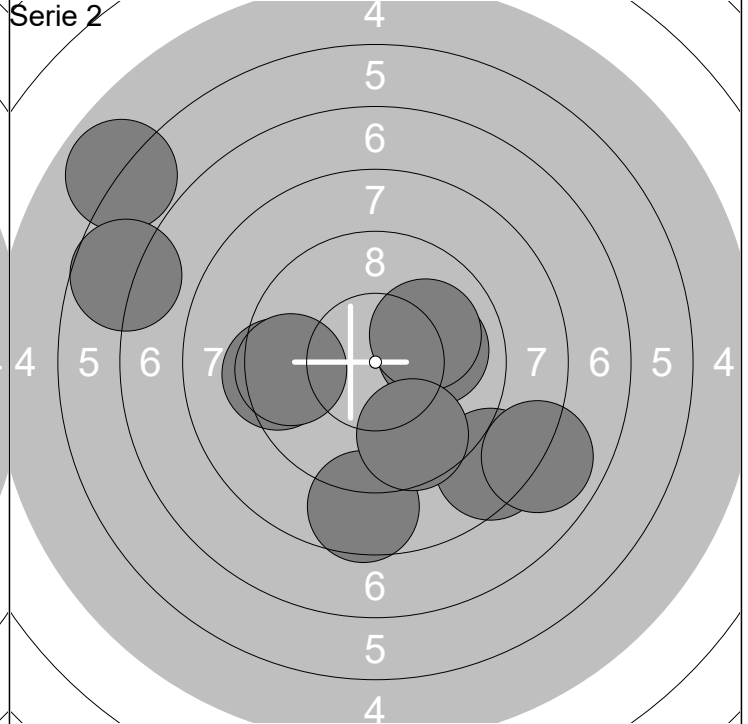
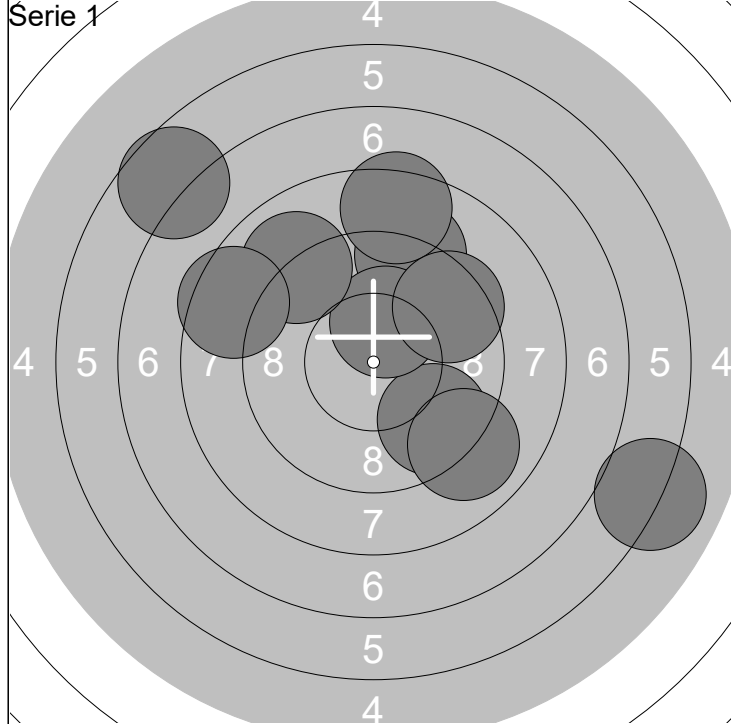

1: 9.6 ↘	6: 10.3x ↗	Serie 86.1
2: 9.0 ↘	7: 9.0 ↗	
3: 9.1 ↗	8: 6.6 ↗	Total 86.1
4: 8.5 ↗	9: 9.5 ↗	
5: 6.0 ↘	10: 8.5 ↖	

11: 9.4 ←	16: 8.5 ↘	Serie 86.2
12: 10.0 →	17: 5.9 ↗	
13: 9.6 ←	18: 9.6 ↘	Total 172.3
14: 8.6 ↓	19: 6.7 ↖	
15: 10.0 ↗	20: 7.9 ↘	

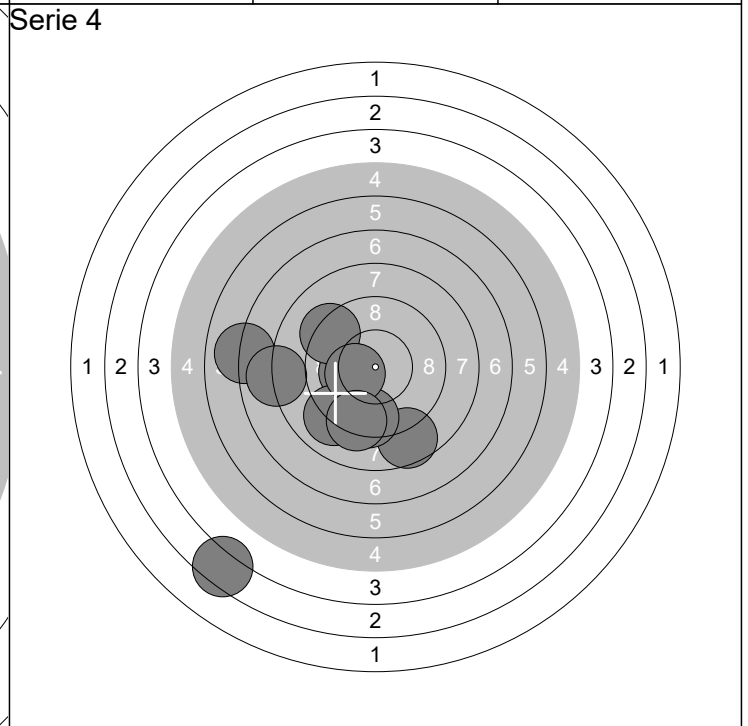
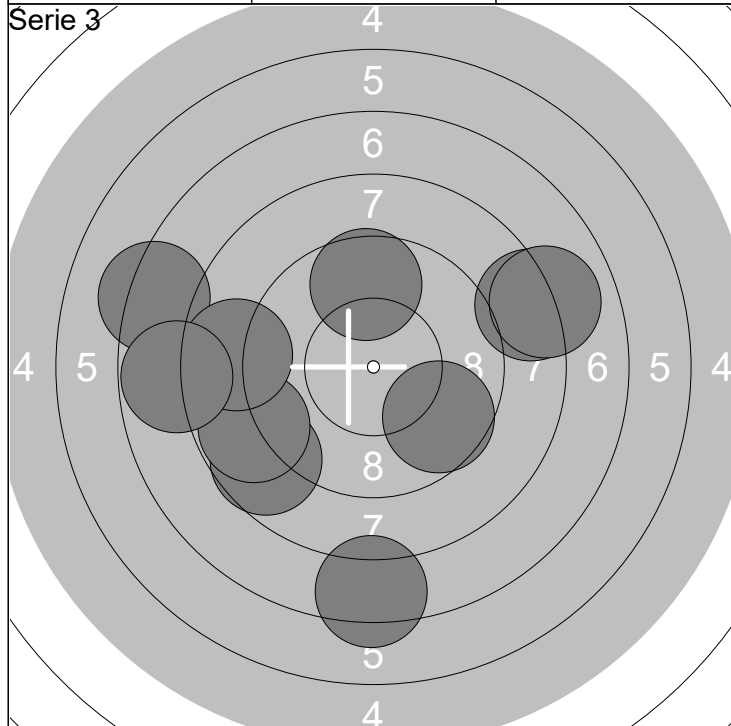

21: 7.3 ←	26: 8.3 →	Serie 84.2
22: 8.7 ↖	27: 8.0 →	
23: 9.6 ↘	28: 7.4 ↓	Total 256.5
24: 8.8 ←	29: 7.8 ←	
25: 8.7 ←	30: 9.6 ↗	

31: 10.1 ←	36: 7.0 ←	Serie 84.4
32: 9.0 ↖	37: 9.3 ↖	
33: 8.6 ↘	38: 10.3x ←	Total 340.9
34: 3.5 ↖	39: 9.2 ↘	
35: 9.4 ↓	40: 8.0 ←	

Rottne Industri Cup 2019

Tolg Skytteförening

Ösm

26.10.2019

Rottne Industri Cup 2019

Söraby SKF

Serie 1

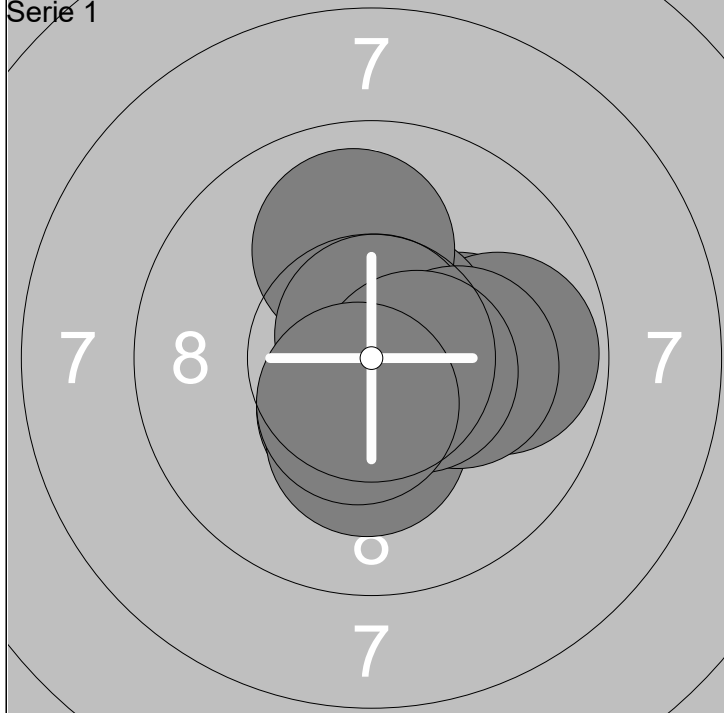

Serie 2

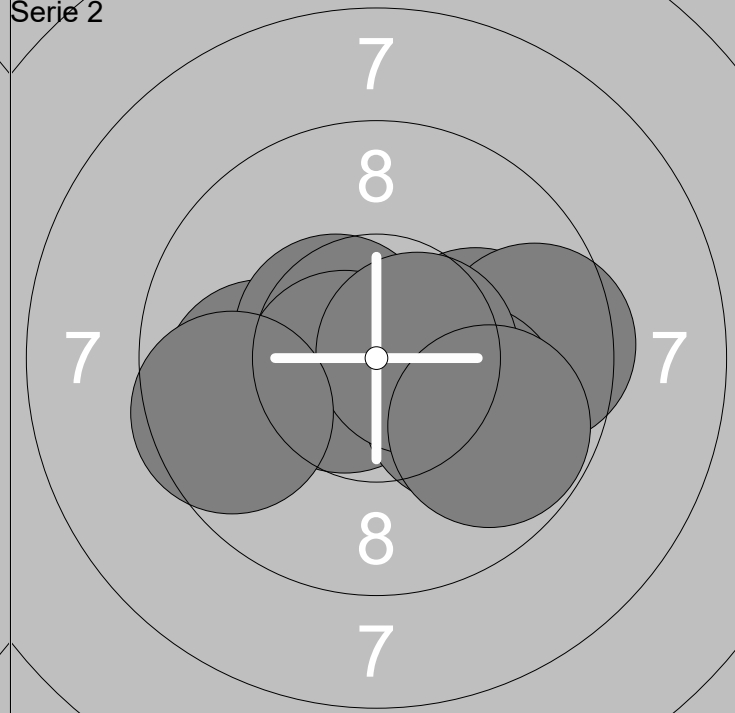

1: 10.5x	↓	6: 10.3x	↓
2: 10.2x	→	7: 10.8x	↑
3: 9.8	→	8: 10.2x	→
4: 10.6x	↗	9: 10.5x	→
5: 10.0	↑	10: 10.5x	↓

Serie 103.4

Total 103.4

11: 10.0	→	16: 10.7x	←
12: 9.9	←	17: 10.1	→
13: 10.5x	↖	18: 10.6x	→
14: 10.0	→	19: 9.6	←
15: 9.6	→	20: 9.8	↘

Serie 100.8

Total 204.2

Serie 3

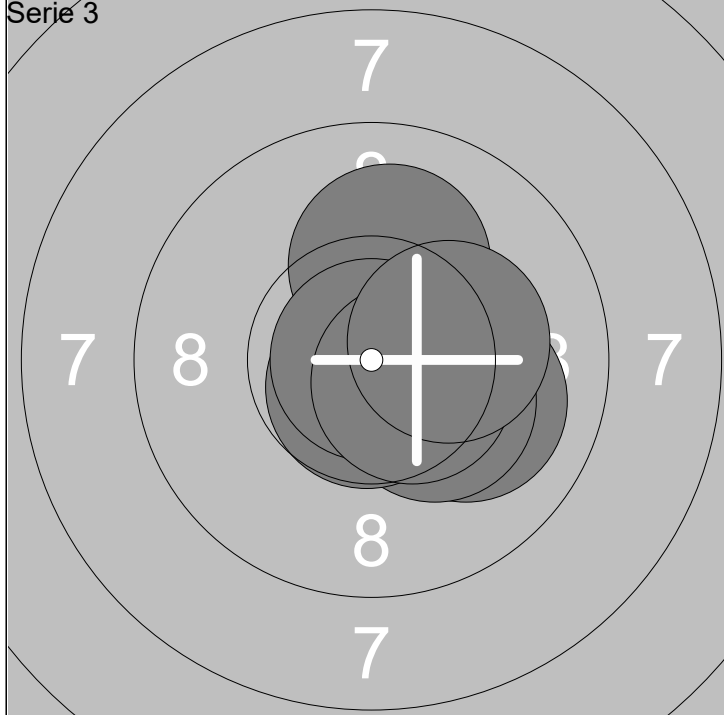

Serie 4

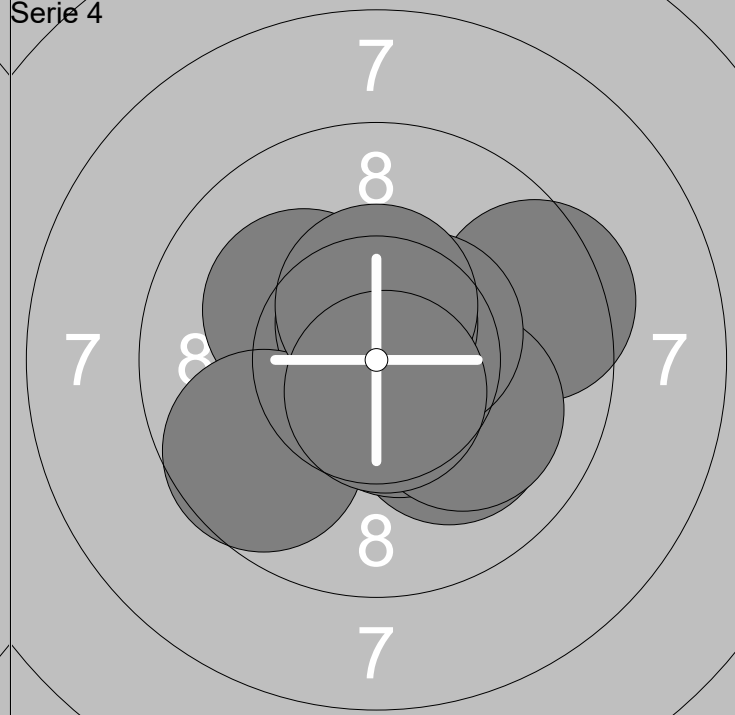

21: 10.1	→	26: 10.1	↑
22: 10.7x	→	27: 10.7x	↓
23: 10.3x	→	28: 10.9x	
24: 10.0	→	29: 10.6x	→
25: 10.3x	↘	30: 10.2x	→

Serie 103.9

Total 308.1

31: 9.4	→	36: 10.5x	↗
32: 10.2x	↖	37: 10.6x	↑
33: 10.1	↓	38: 9.7	↙
34: 10.6x	↘	39: 10.5x	↑
35: 10.1	↘	40: 10.7x	↓

Serie 102.4

Total 410.5

Rottne Industri Cup 2019

Serie 1

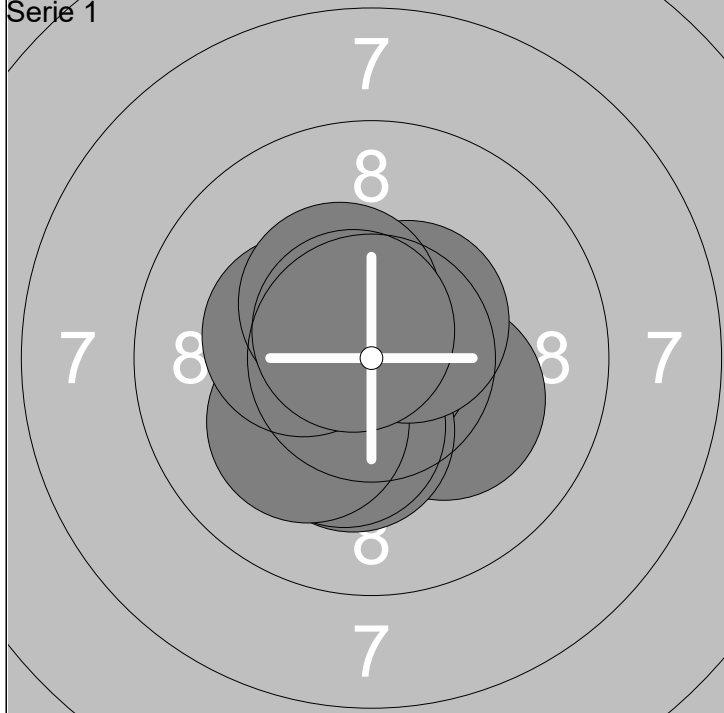

Serie 2

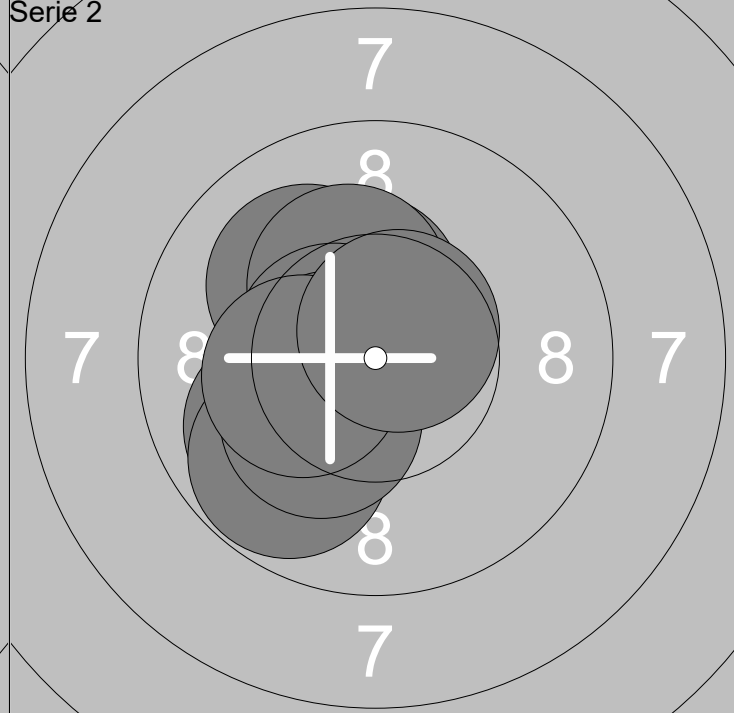

1: 10.2x ↘  
2: 10.9x  
3: 10.3x ↓  
4: 10.3x ↓  
5: 10.2x ↙

6: 10.6x ↑  
7: 10.3x ←  
8: 10.5x ↗  
9: 10.4x ↖  
10: 10.7x ↗

Serie 104.4  
Total 104.4

11: 10.1 ↖  
12: 10.4x ↑  
13: 10.3x ↑  
14: 10.0 ↙  
15: 9.8 ↙

16: 10.6x ↖  
17: 10.6x ←  
18: 10.2x ↙  
19: 10.3x ←  
20: 10.6x ↗

Serie 102.9  
Total 207.3

Serie 3

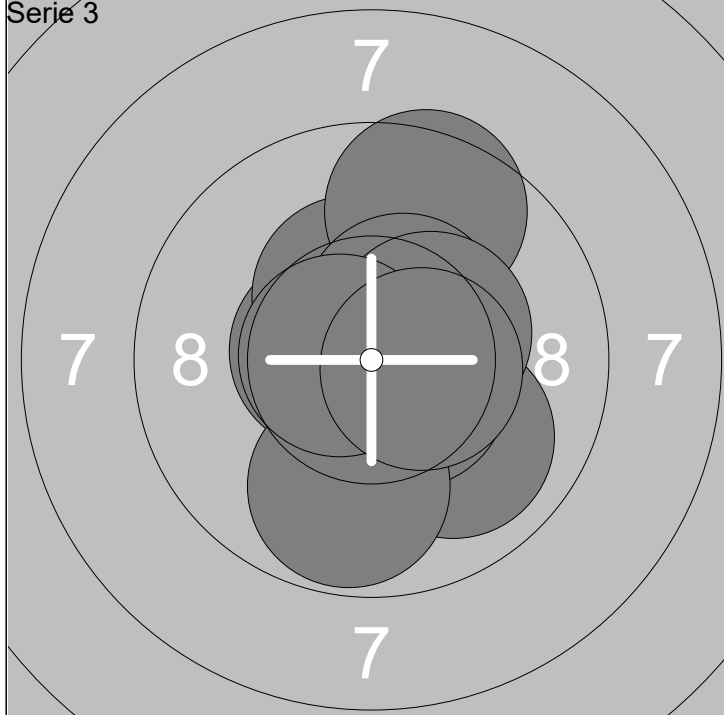

Serie 4

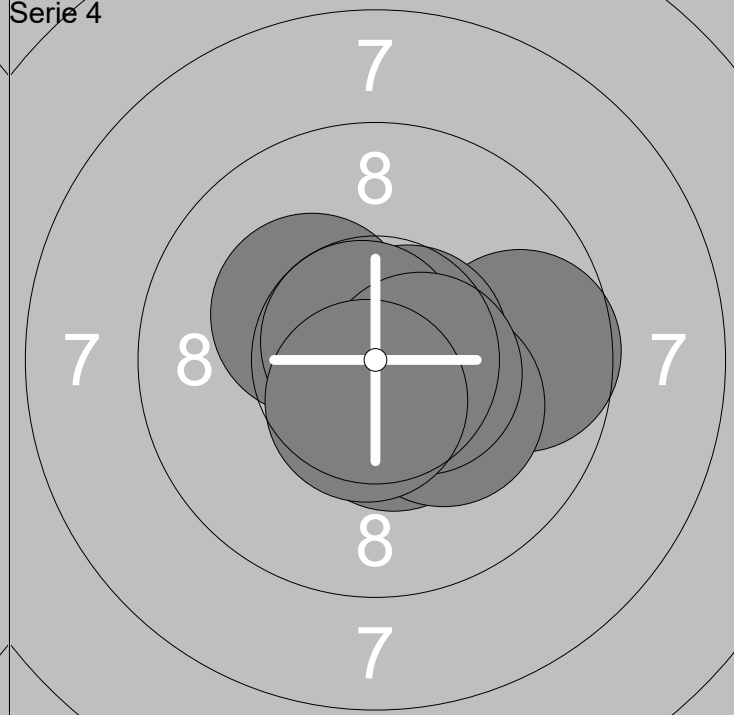

21: 10.6x ←  
22: 10.4x ↑  
23: 9.5 ↑  
24: 10.5x ↗  
25: 10.0 ↘

26: 10.4x ↗  
27: 10.6x ↘  
28: 9.8 ↓  
29: 10.7x ←  
30: 10.5x →

Serie 103.0  
Total 310.3

31: 10.2x ↖  
32: 9.7 →  
33: 10.6x →  
34: 10.5x ↓  
35: 10.6x →

36: 10.7x ↓  
37: 10.8x ↗  
38: 10.2x ↘  
39: 10.5x →  
40: 10.6x ↓

Serie 104.4  
Total 414.7

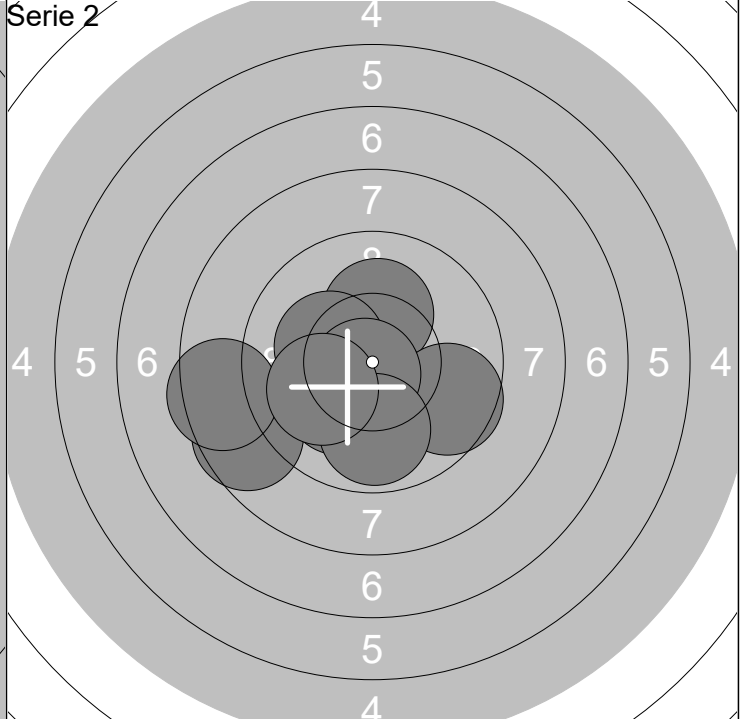
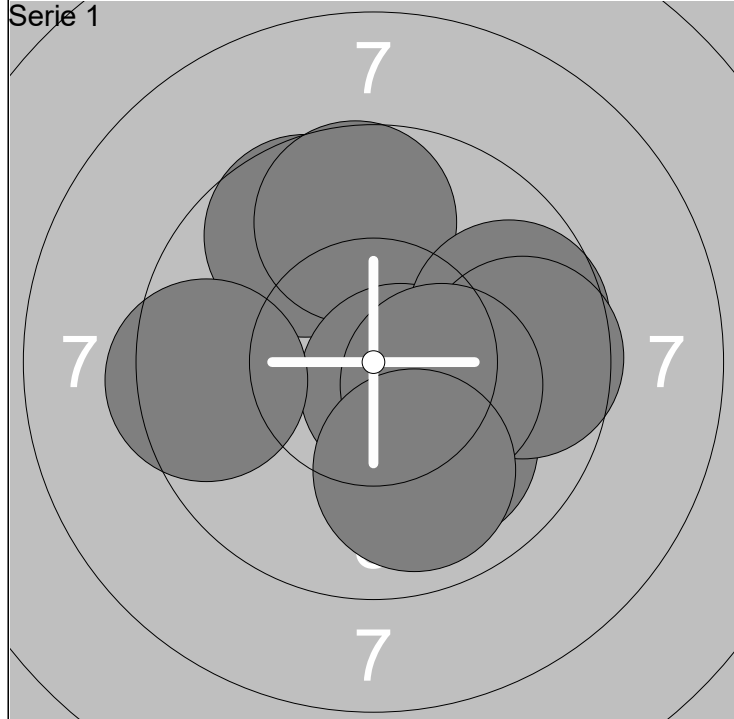

1: 9.7 ↗	6: 10.0 ↘	Serie	98.9
2: 9.7 ↑	7: 9.6 →		
3: 10.6x ↘	8: 10.3x →	Total	98.9
4: 9.9 →	9: 9.5 ←		
5: 9.7 →	10: 9.9 ↘		

11: 10.2x ↑	16: 9.6 →	Serie	98.4
12: 10.2x ↘	17: 10.7x ↘		
13: 10.2x ←	18: 9.9 ↓	Total	197.3
14: 10.5x ↓	19: 8.5 ←		
15: 8.6 ←	20: 10.0 ↙		

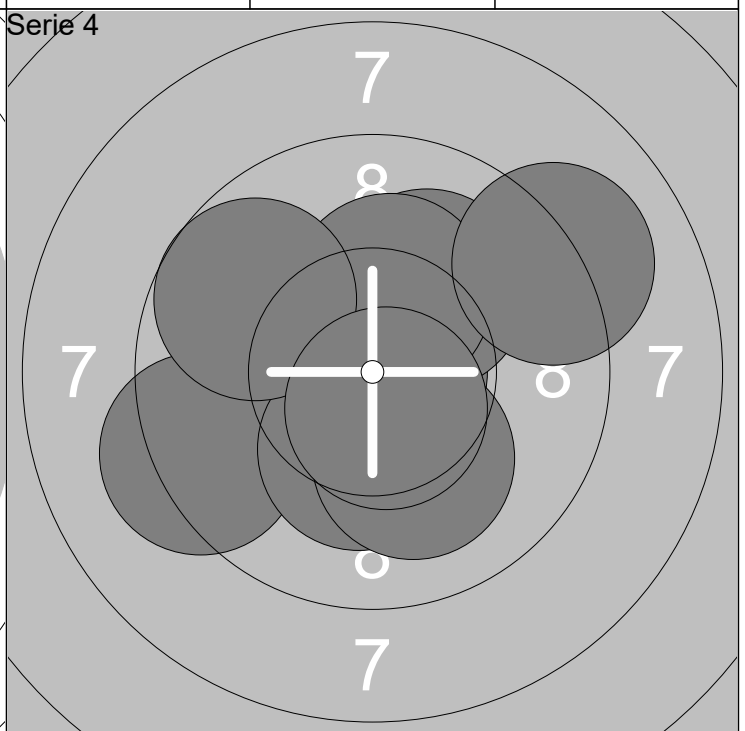
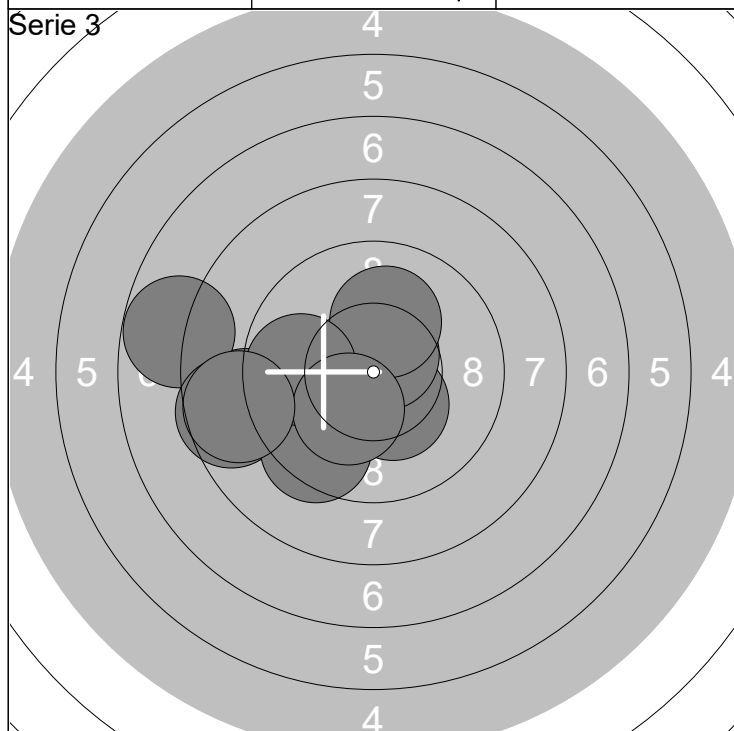

21: 10.3x ↘	26: 9.4 ↙	Serie	94.4
22: 10.6x ↗	27: 10.1 ↑		
23: 8.9 ←	28: 9.8 ←	Total	291.7
24: 7.8 ←	29: 10.2x ↘		
25: 8.6 ←	30: 8.7 ←		

31: 10.5x ←	36: 10.3x ↑	Serie	100.8
32: 9.3 ←	37: 9.7 ↙		
33: 10.8x →	38: 10.1 ↓	Total	392.5
34: 10.1 ↗	39: 10.6x ↘		
35: 10.3x ↓	40: 9.1 ↗		

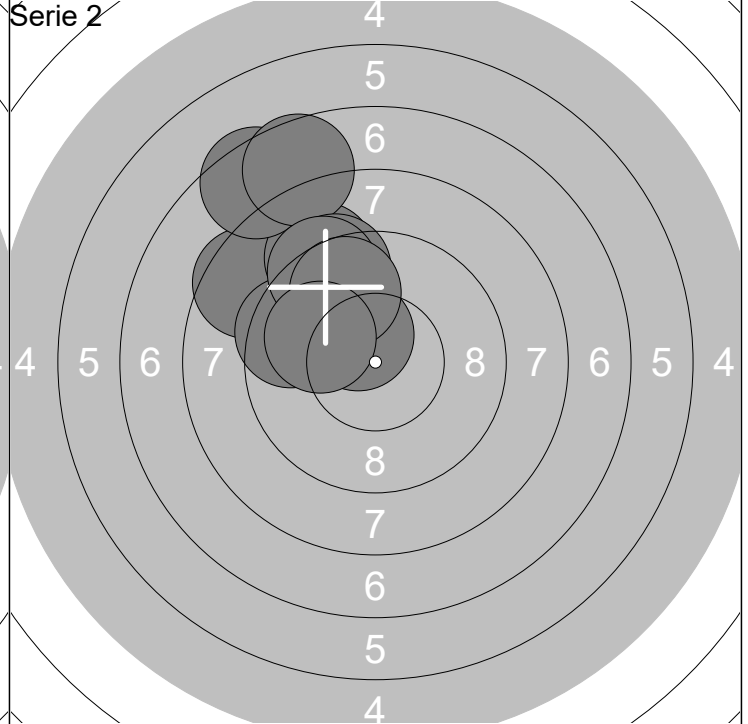
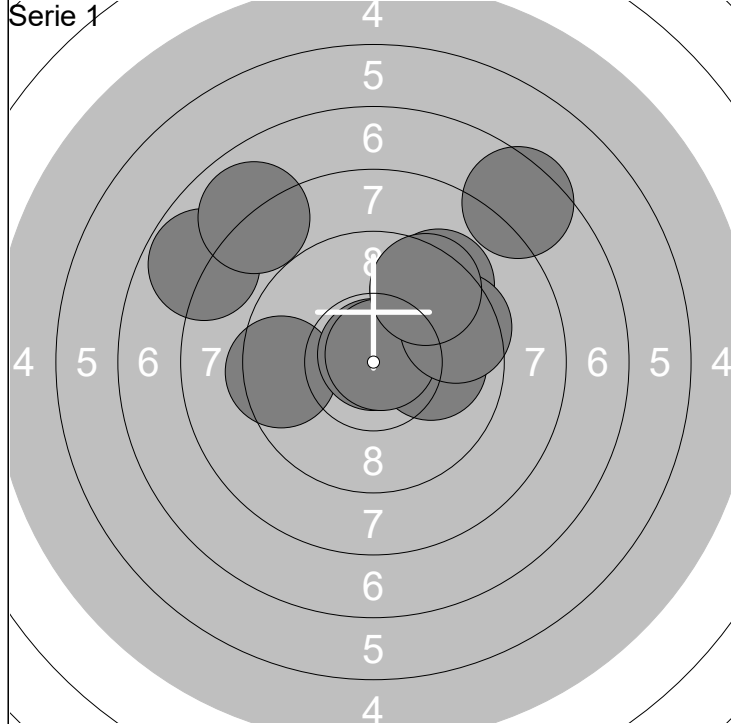

1: 7.8 ↖	6: 10.8x ↗	Serie	92.6
2: 10.0 →	7: 7.9 ↖		
3: 9.5 ←	8: 7.5 ↗	Total	92.6
4: 9.3 ↗	9: 9.5 →		
5: 10.8x ↑	10: 9.5 ↗		

11: 8.5 ↖	16: 9.3 ↗	Serie	90.9
12: 9.5 ←	17: 9.3 ↗		
13: 9.1 ↗	18: 10.4x ↗	Total	183.5
14: 7.5 ↗	19: 9.7 ↗		
15: 7.6 ↗	20: 10.0 ←		

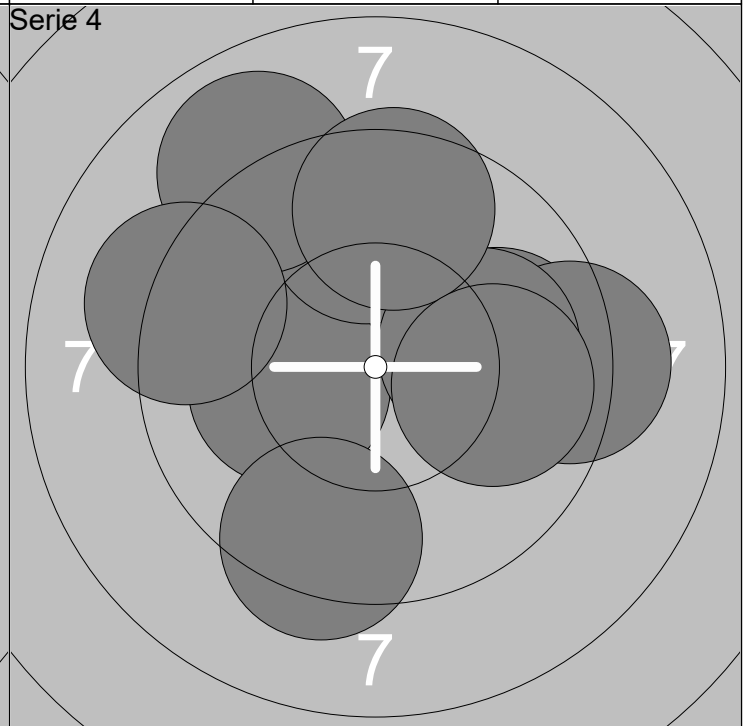
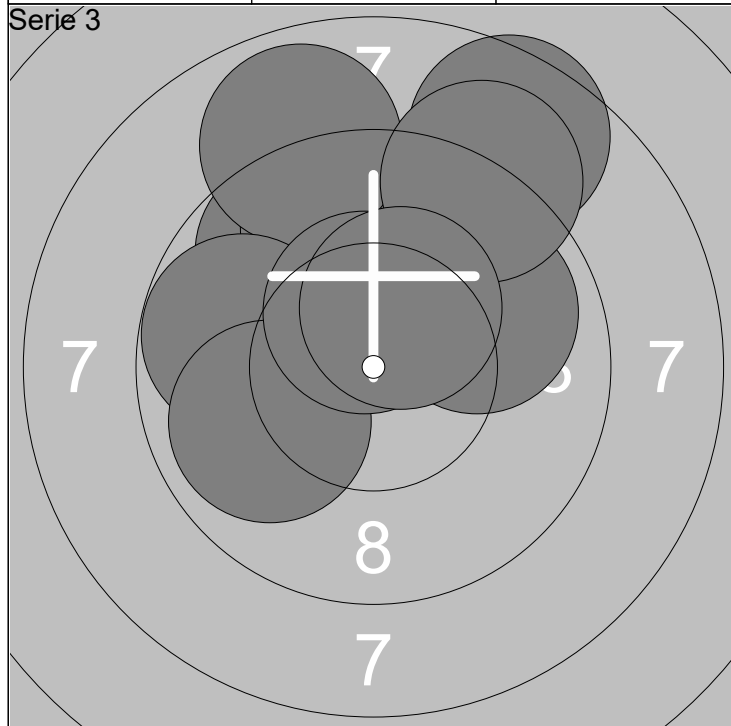

21: 8.6 ↗	26: 9.7 ←	Serie	96.3
22: 9.7 ↖	27: 9.0 ↗		
23: 9.7 ↑	28: 9.9 ←	Total	279.8
24: 8.9 ↑	29: 10.5x ↑		
25: 9.9 →	30: 10.4x ↗		

31: 10.2x ←	36: 9.2 →	Serie	96.0
32: 9.7 ↑	37: 10.0 →		
33: 8.9 ↗	38: 9.2 ←	Total	375.8
34: 9.9 →	39: 9.6 ↑		
35: 9.4 ↓	40: 9.9 →		

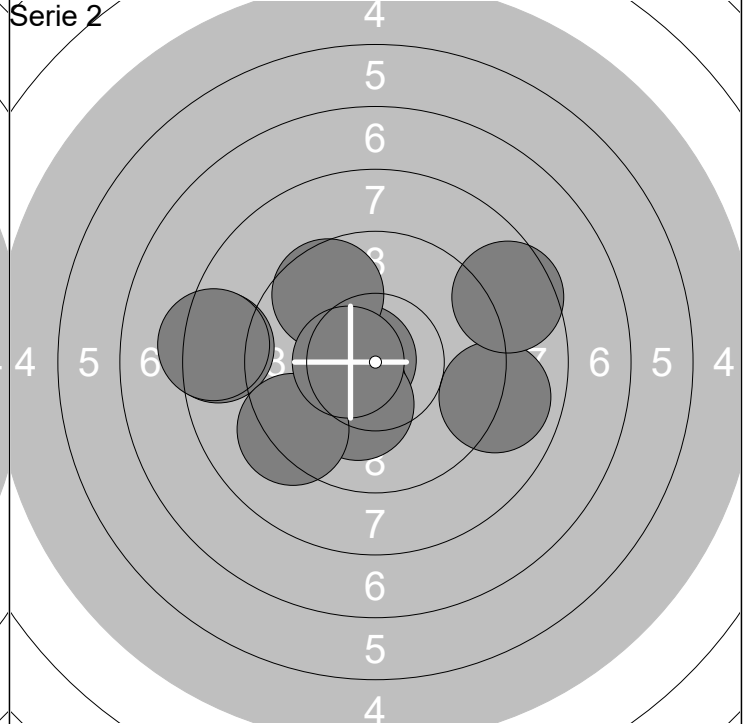
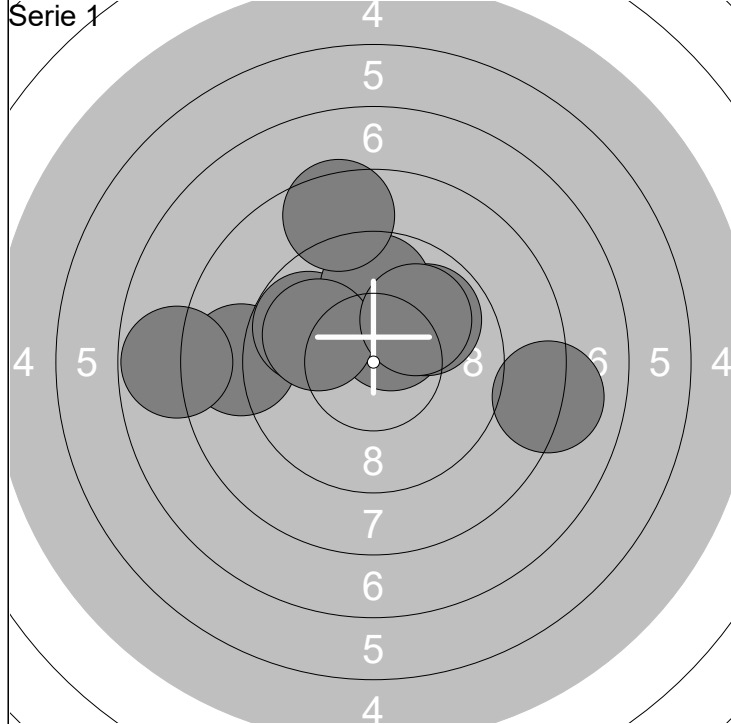

1: 10.4x ↗	6: 10.0 ↖	Serie	93.1
2: 9.9 ↗	7: 10.0 ↗		
3: 8.8 ←	8: 8.1 →	Total	93.1
4: 9.8 ↖	9: 7.8 ←		
5: 9.8 ↑	10: 8.5 ↑		

11: 10.7x ←	16: 10.2x ↓	Serie	94.8
12: 9.6 ↗	17: 9.2 ↘		
13: 8.9 →	18: 10.5x ←	Total	187.9
14: 10.4x ↘	19: 8.3 ←		
15: 8.4 ←	20: 8.6 ↗		

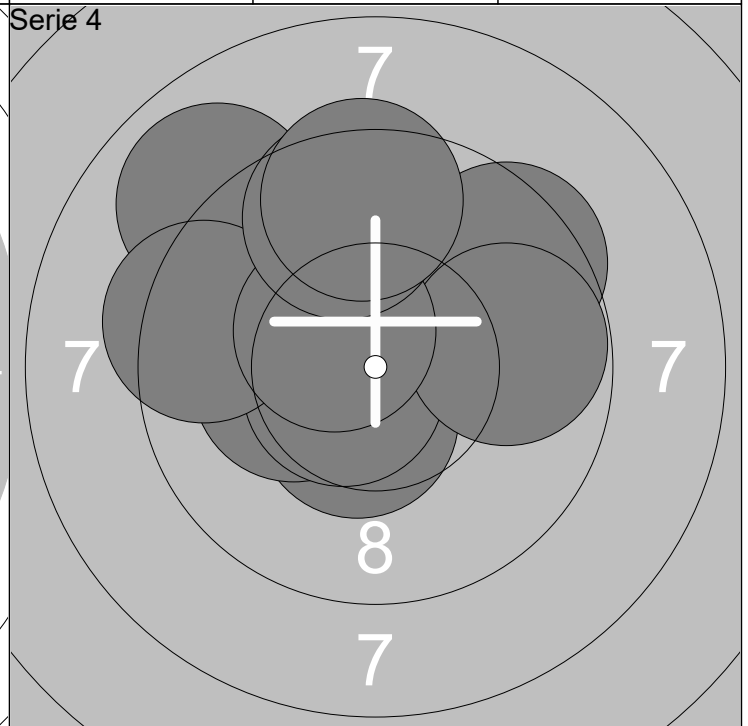
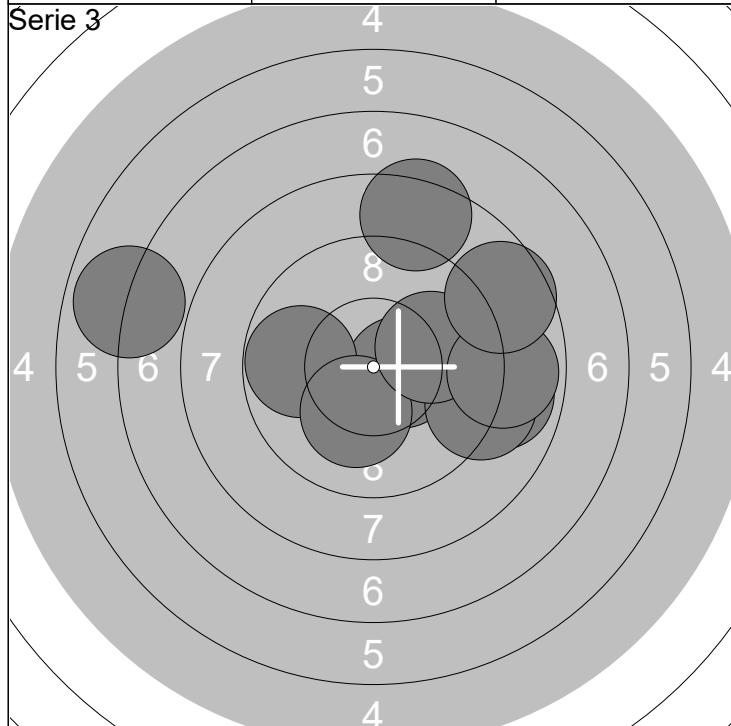

21: 10.5x →	26: 9.1 →	Serie	91.3
22: 8.9 →	27: 10.0 →		
23: 9.8 ←	28: 8.9 →	Total	279.2
24: 10.2x ↓	29: 8.6 ↗		
25: 6.9 ←	30: 8.4 ↑		

31: 10.5x ↓	36: 9.4 ←	Serie	98.5
32: 9.5 ↗	37: 9.8 →		
33: 10.2x ←	38: 10.5x ↖	Total	377.7
34: 8.9 ↖	39: 9.6 ↑		
35: 10.6x ↙	40: 9.5 ↑		

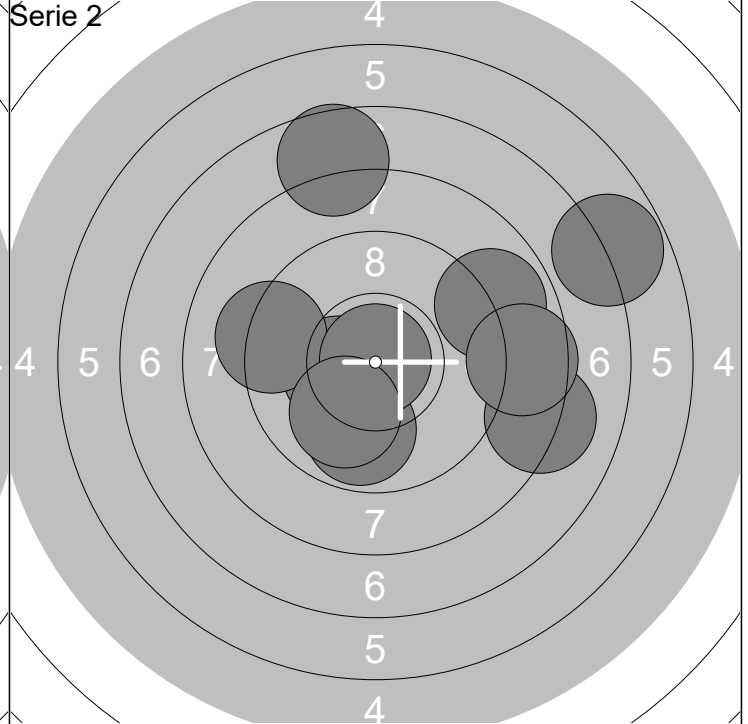
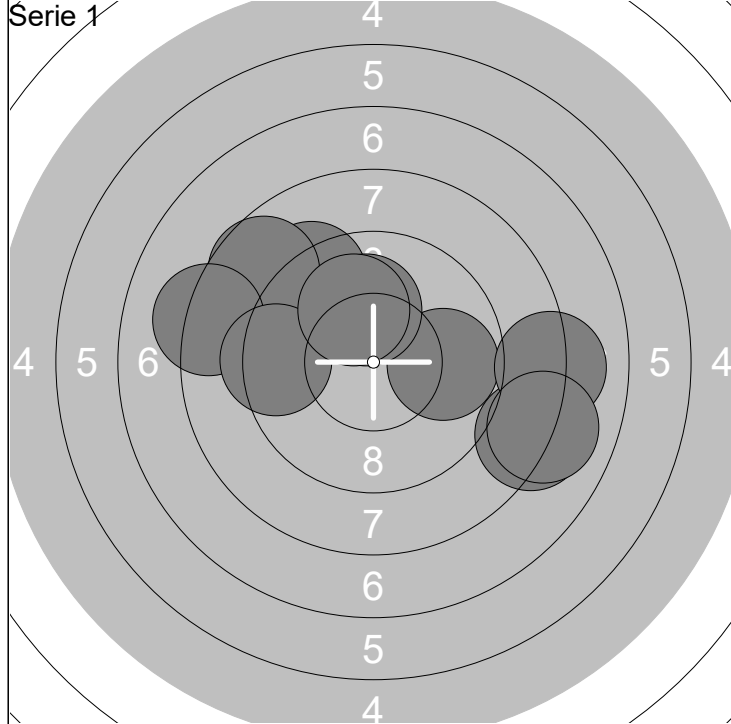

1: 9.3 ↗	6: 8.1 →	Serie	89.8
2: 8.7 ↗	7: 9.4 ←		
3: 8.2 ↘	8: 10.1 ↑	Total	89.8
4: 8.2 ↖	9: 8.0 ↘		
5: 9.8 →	10: 10.0 ↗		

11: 9.9 ↓	16: 10.9x ↑	Serie	90.4
12: 8.2 →	17: 6.8 ↗		
13: 8.9 ↗	18: 10.0 ↓	Total	180.2
14: 10.3x ←	19: 8.6 →		
15: 9.2 ←	20: 7.6 ↑		

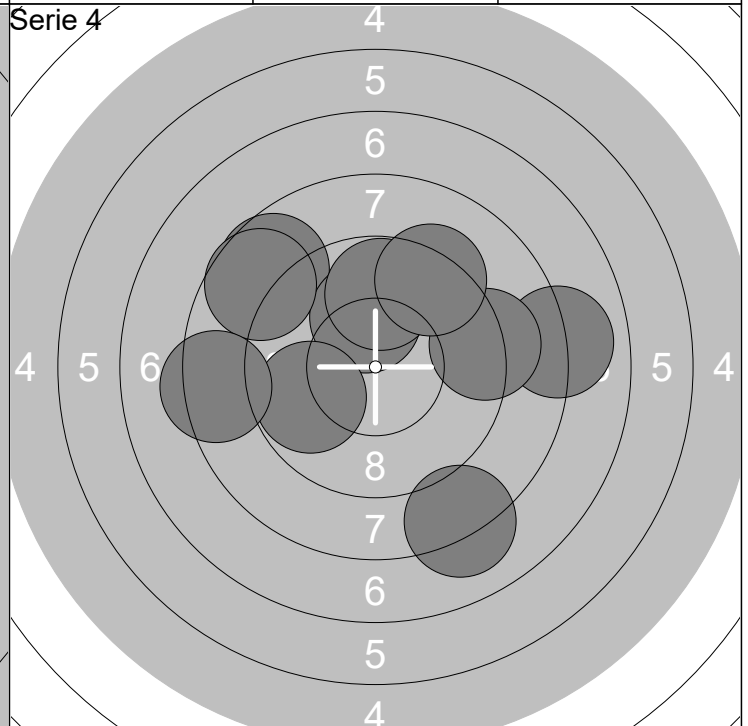
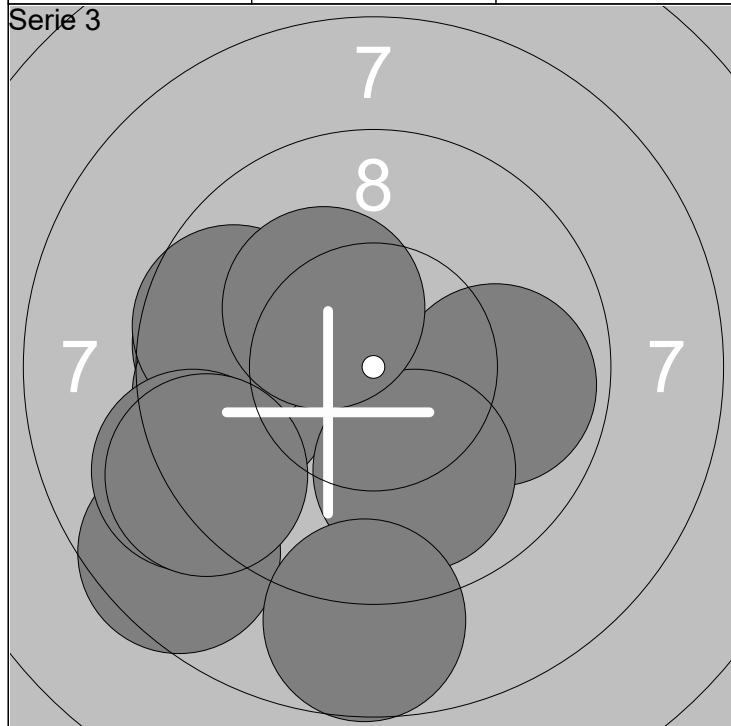

21: 9.9 →	26: 10.0 ↓	Serie	94.8
22: 9.7 ←	27: 8.7 ↓		
23: 9.7 ←	28: 10.3x ↗	Total	275.0
24: 9.6 ←	29: 9.1 ←		
25: 8.6 ↘	30: 9.2 ↘		

31: 8.7 ↖	36: 9.8 ↑	Serie	90.1
32: 8.0 →	37: 9.2 →		
33: 10.1 ↑	38: 9.3 ↗	Total	365.1
34: 8.1 ↓	39: 8.7 ↖		
35: 9.8 ←	40: 8.4 ←		

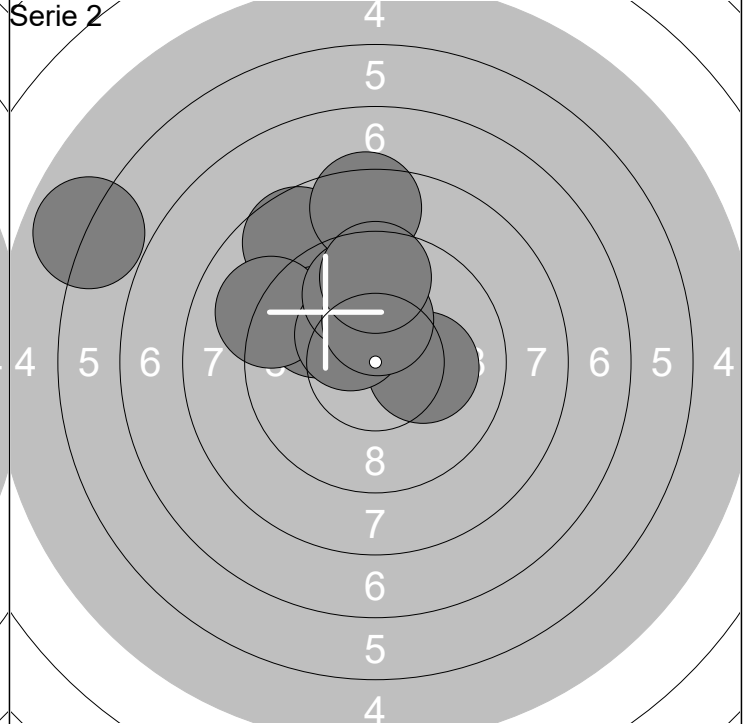
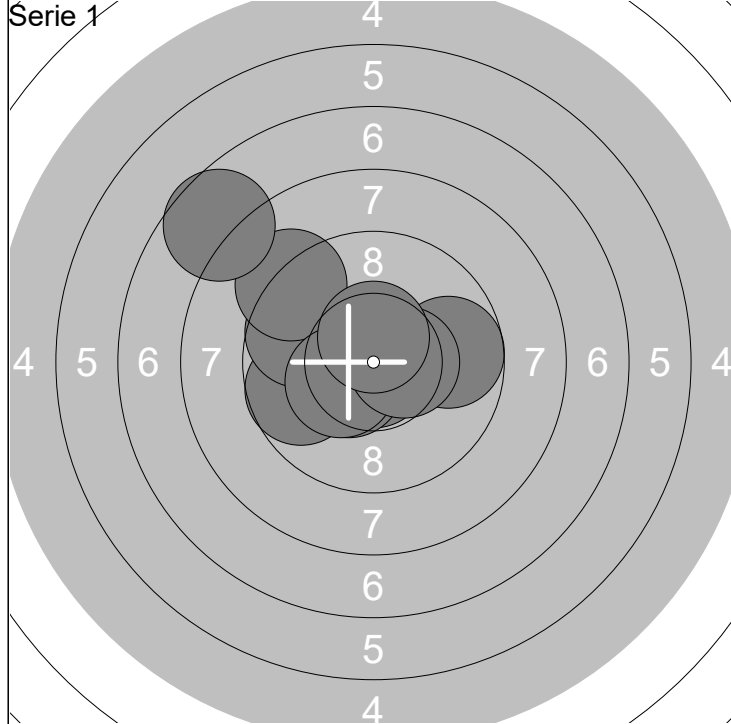

1: 10.8x ↓	6: 9.1 ↗	Serie	98.4
2: 9.7 ←	7: 7.6 ↗		
3: 10.4x ↙	8: 10.4x ←	Total	98.4
4: 9.7 ↖	9: 10.4x →		
5: 9.7 →	10: 10.6x ↑		

11: 8.6 ↗	16: 5.9 ↖	Serie	92.0
12: 9.8 ↗	17: 9.8 ↑		
13: 9.1 ↗	18: 8.4 ↑	Total	190.4
14: 10.2x →	19: 10.3x ↑		
15: 10.3x ↗	20: 9.6 ↑		

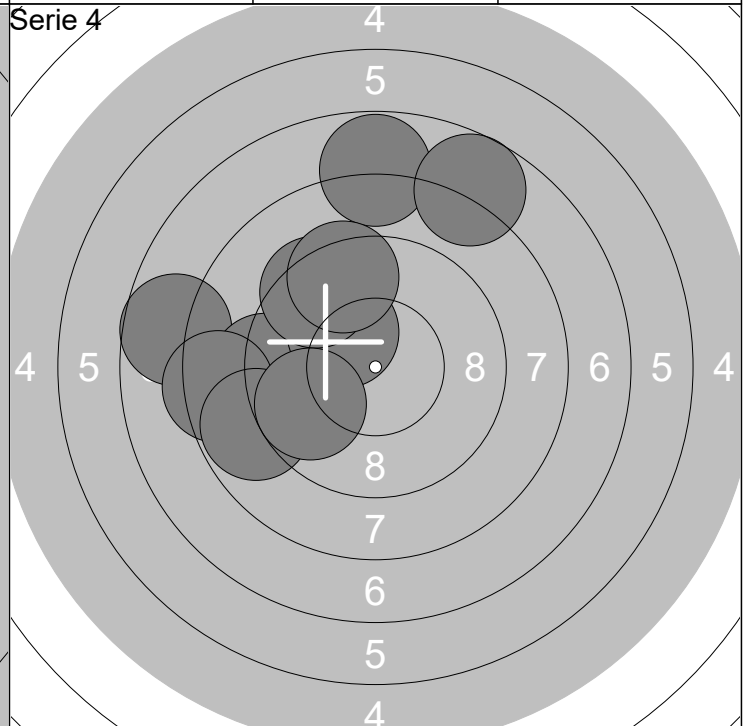
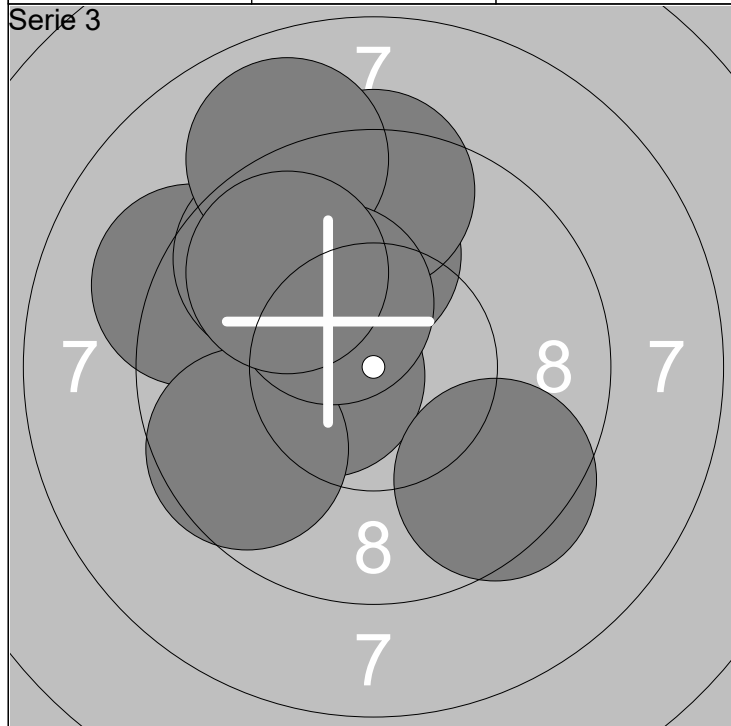

21: 10.5x ←	26: 9.6 ↗	Serie	96.8
22: 9.2 ↖	27: 9.0 ↗		
23: 9.9 ↑	28: 9.5 ↘	Total	287.2
24: 9.6 ↖	29: 10.3x ↗		
25: 9.4 ↑	30: 9.8 ↗		

31: 7.8 ↑	36: 8.8 ←	Serie	88.3
32: 7.7 ←	37: 9.4 ↗		
33: 9.2 ←	38: 9.4 ↑	Total	375.5
34: 10.2x ↗	39: 9.7 ↖		
35: 8.4 ←	40: 7.7 ↗		



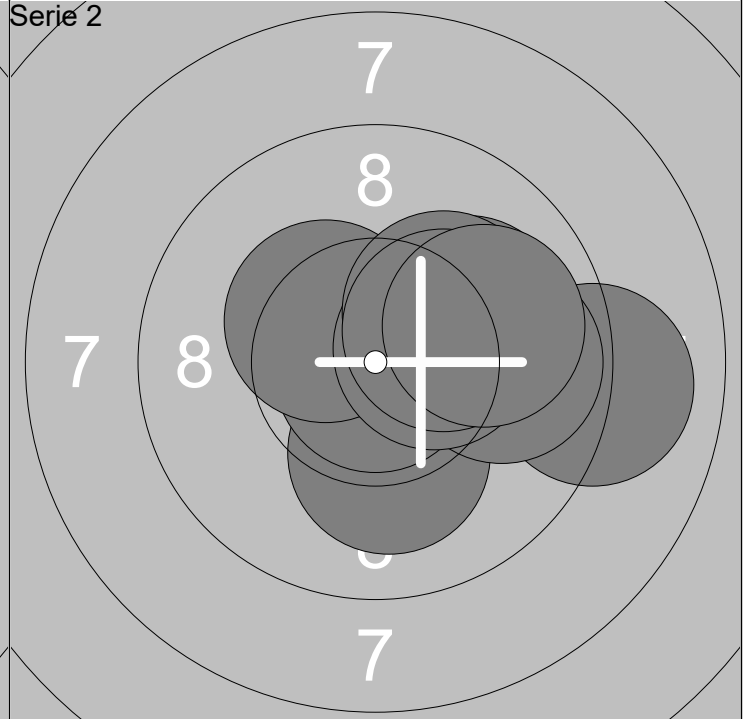
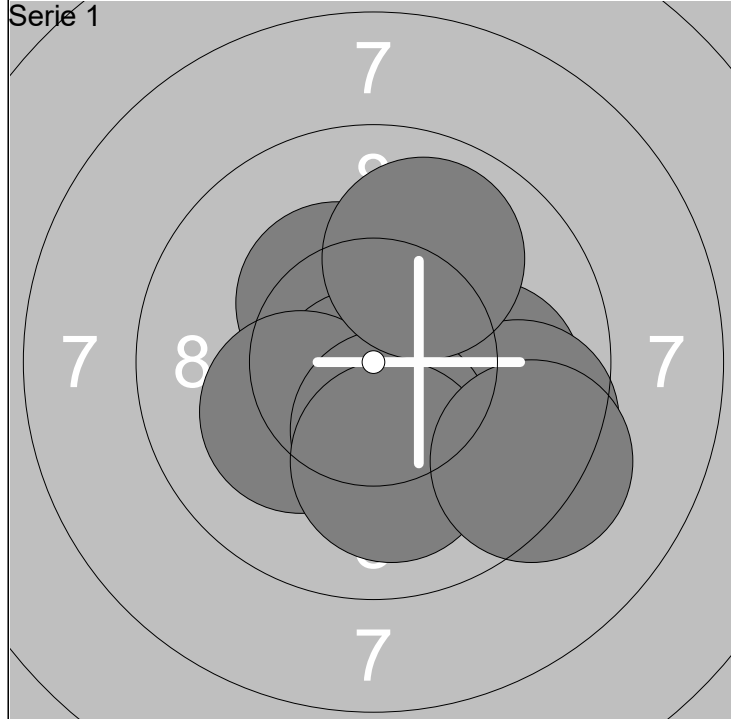

1: 10.3x ↗	6: 9.6 →	Serie	100.2
2: 10.0 →	7: 10.3x ↓		
3: 10.7x ↓	8: 10.0 ↓	Total	100.2
4: 9.9 ↘	9: 9.3 ↘		
5: 10.2x ↙	10: 9.9 ↗		

11: 10.1 ↓	16: 10.4x ↖	Serie	101.1
12: 9.0 →	17: 10.4x →		
13: 10.9x ↓	18: 10.2x ↗	Total	201.3
14: 9.8 →	19: 10.3x ↗		
15: 10.1 ↗	20: 9.9 →		

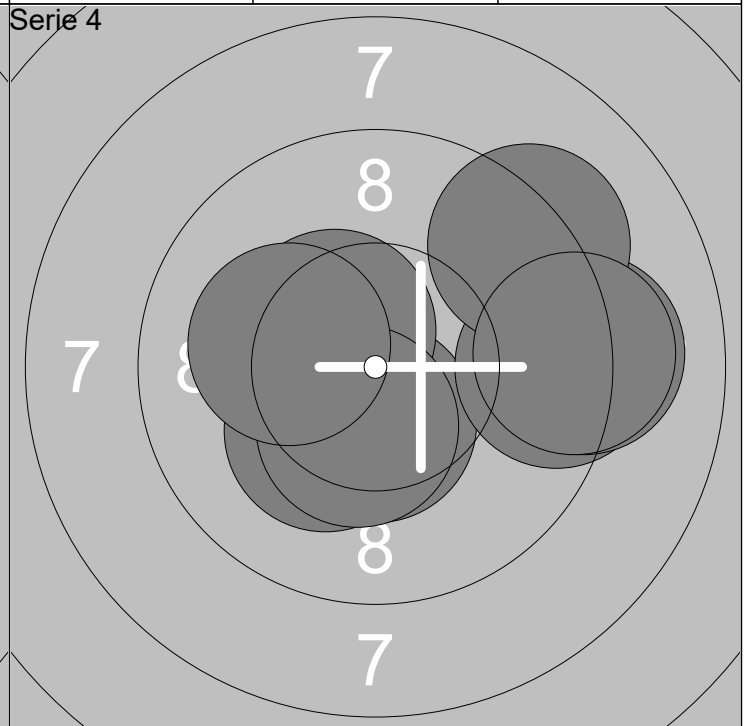
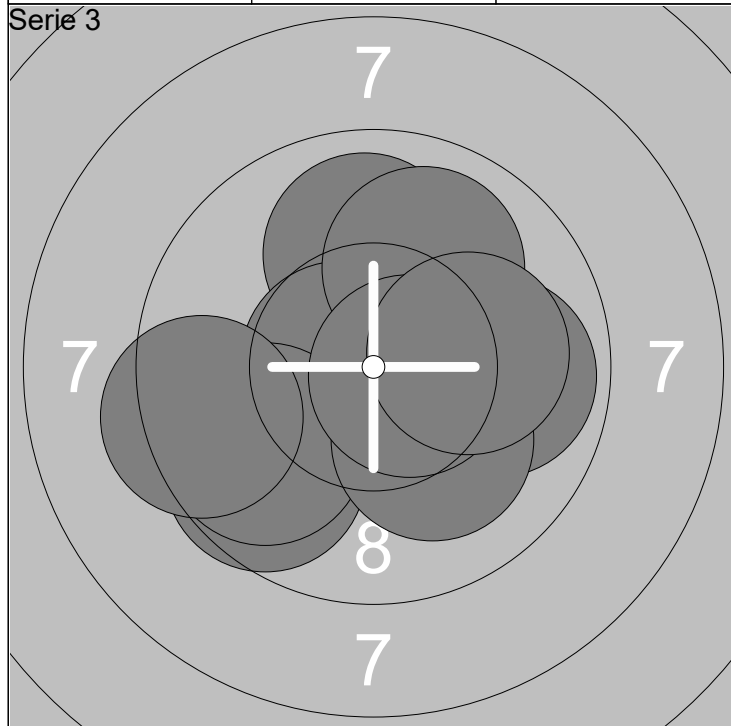

21: 9.9 ↑	26: 9.8 ←	Serie	99.8
22: 10.7x ←	27: 9.3 ←		
23: 9.8 →	28: 10.1 ↓	Total	301.1
24: 9.9 ↗	29: 10.6x →		
25: 9.6 ↙	30: 10.1 →		

31: 10.5x ↓	36: 10.4x ←	Serie	99.0
32: 9.3 →	37: 10.5x ↖		
33: 9.1 →	38: 10.2x ↘	Total	400.1
34: 9.2 ↗	39: 10.4x ↓		
35: 9.2 →	40: 10.2x ←		

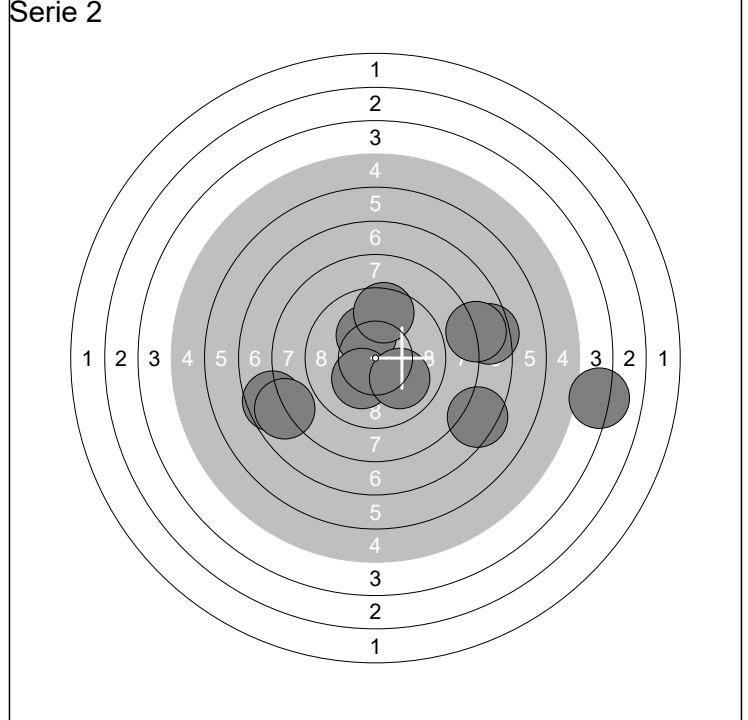
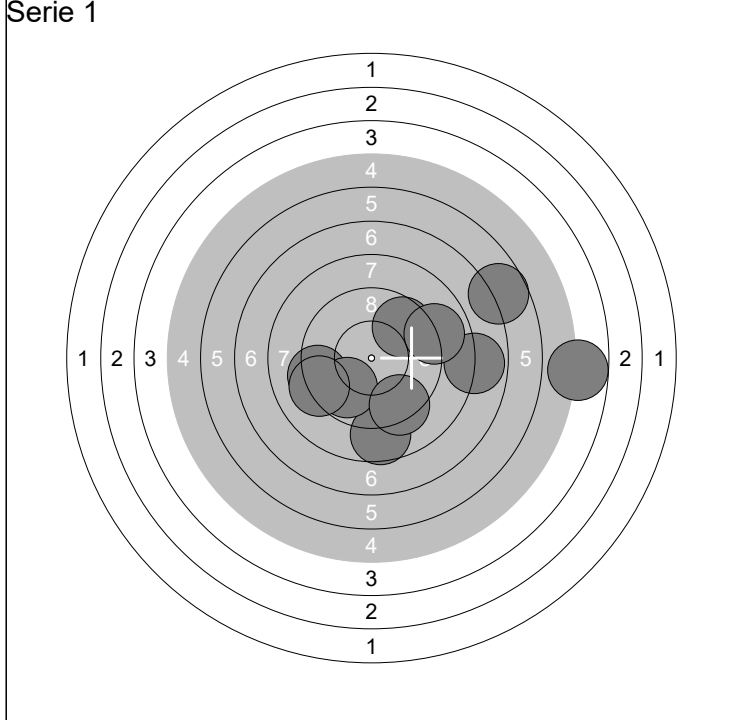

1: 4.8 →	6: 9.8 ↙	Serie	84.2
2: 9.6 ↗	7: 7.9 →		
3: 6.7 ↗	8: 9.2 ←	Total	84.2
4: 9.3 ←	9: 9.3 ↘		
5: 8.7 ↓	10: 8.9 →		

11: 7.5 →	16: 4.1 →	Serie	82.2
12: 7.4 ↘	17: 7.6 ←		
13: 10.2x ↗	18: 10.2x ↘	Total	166.4
14: 7.8 →	19: 7.8 ←		
15: 9.6 ↑	20: 10.0 ↘		

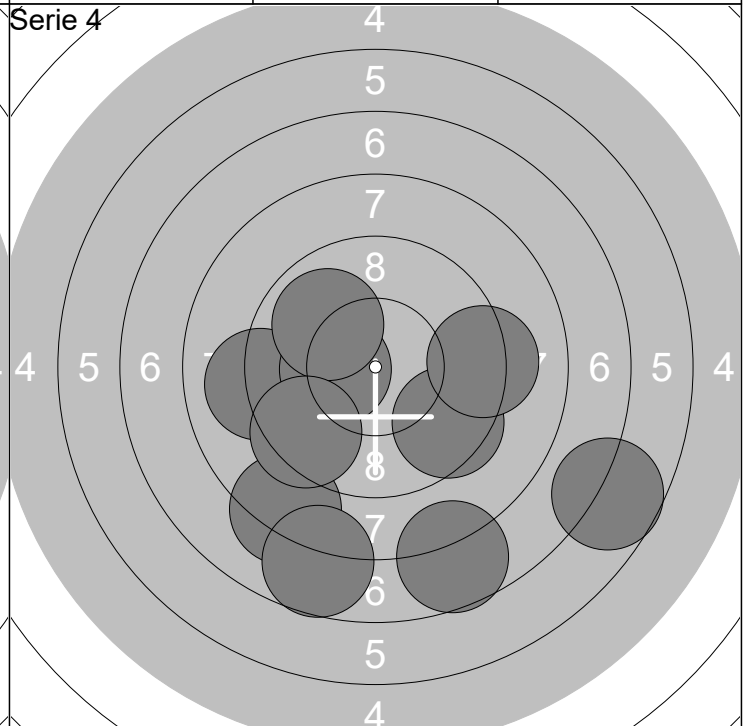
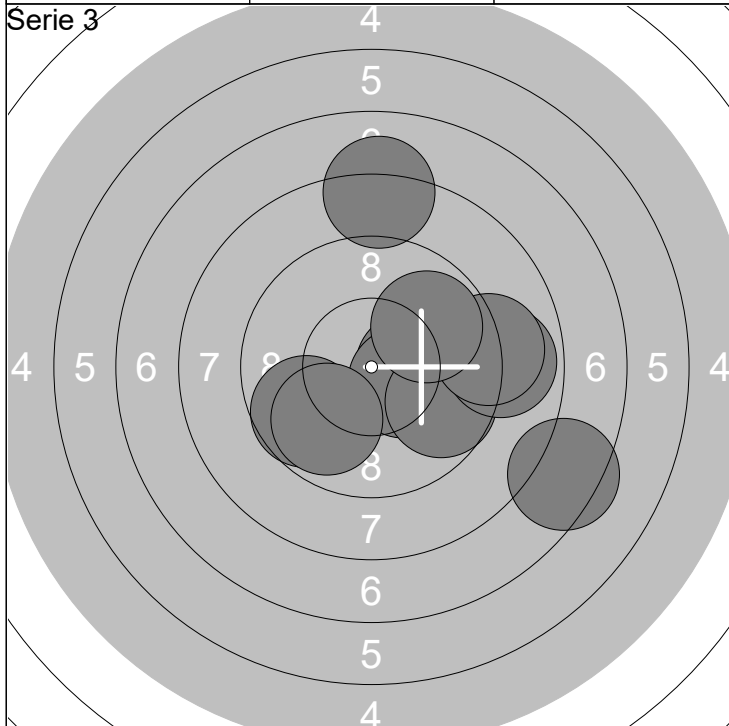

21: 10.3x →	26: 9.8 ↙	Serie	93.3
22: 10.4x ↘	27: 8.1 ↑		
23: 9.7 ↘	28: 9.1 →	Total	259.7
24: 8.9 →	29: 7.4 ↘		
25: 9.7 ↙	30: 9.9 ↗		

31: 8.3 ↙	36: 9.9 ↗	Serie	87.8
32: 7.7 ↘	37: 7.7 ↘		
33: 9.1 ←	38: 6.7 ↘	Total	347.5
34: 10.3x ←	39: 9.2 →		
35: 9.5 ↘	40: 9.4 ↙		

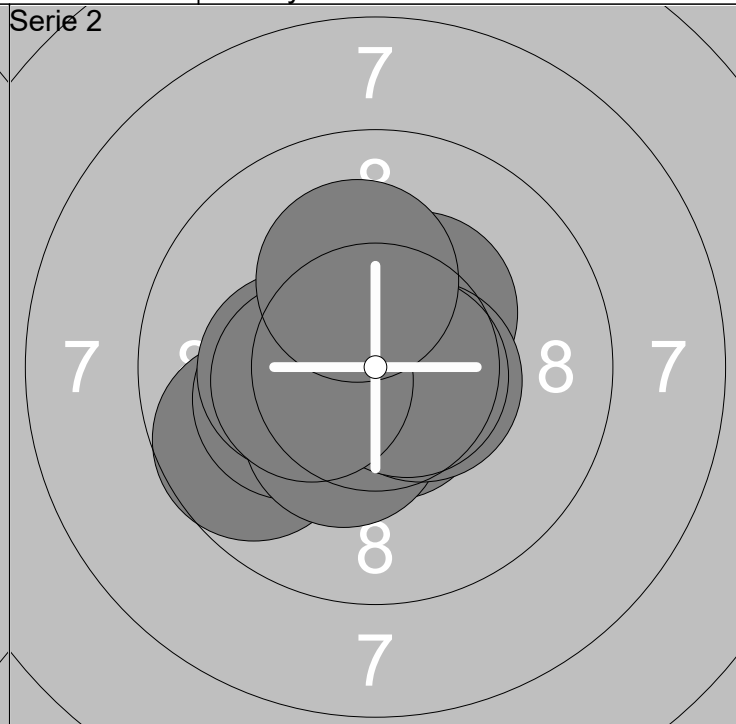
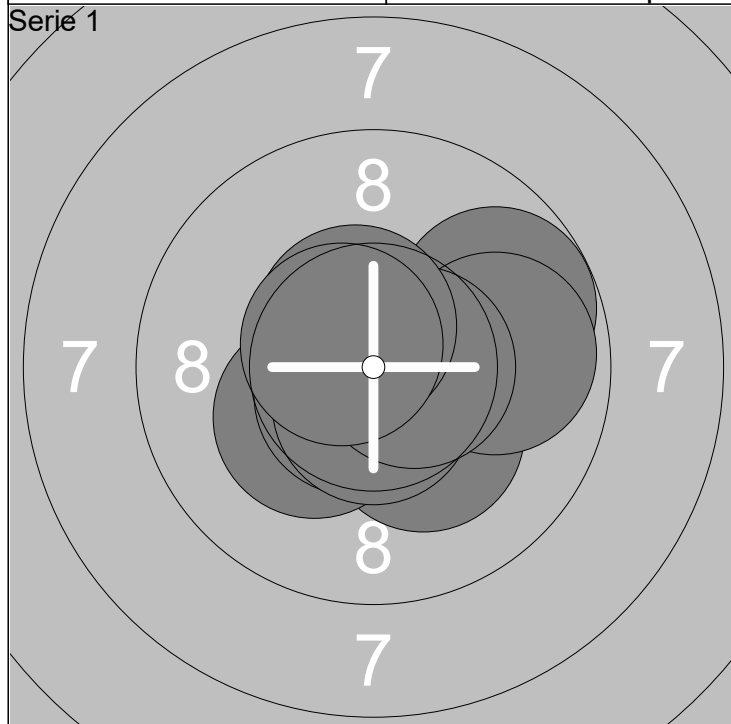

1: 10.7x →	6: 10.7x ↘	Serie	104.0
2: 10.3x ↘	7: 10.6x ↓		
3: 9.7 ↗	8: 10.6x →	Total	104.0
4: 9.9 →	9: 10.6x ↗		
5: 10.3x ↙	10: 10.6x ↖		

11: 10.3x ↗	16: 10.4x ↘	Serie	103.4
12: 10.7x ↘	17: 10.5x →		
13: 9.7 ↙	18: 10.7x →	Total	207.4
14: 10.2x ↙	19: 10.4x ↙		
15: 10.3x ↙	20: 10.2x ↗		

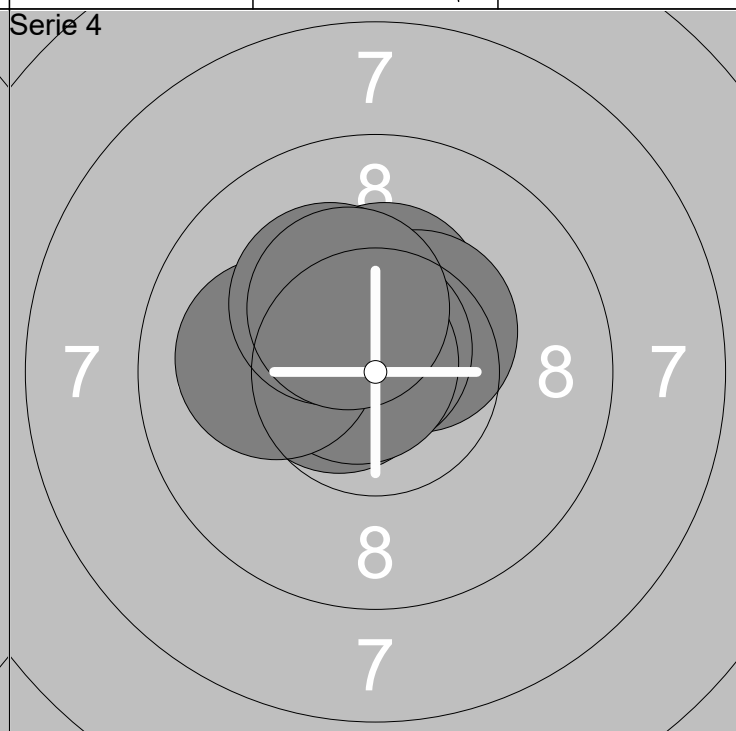
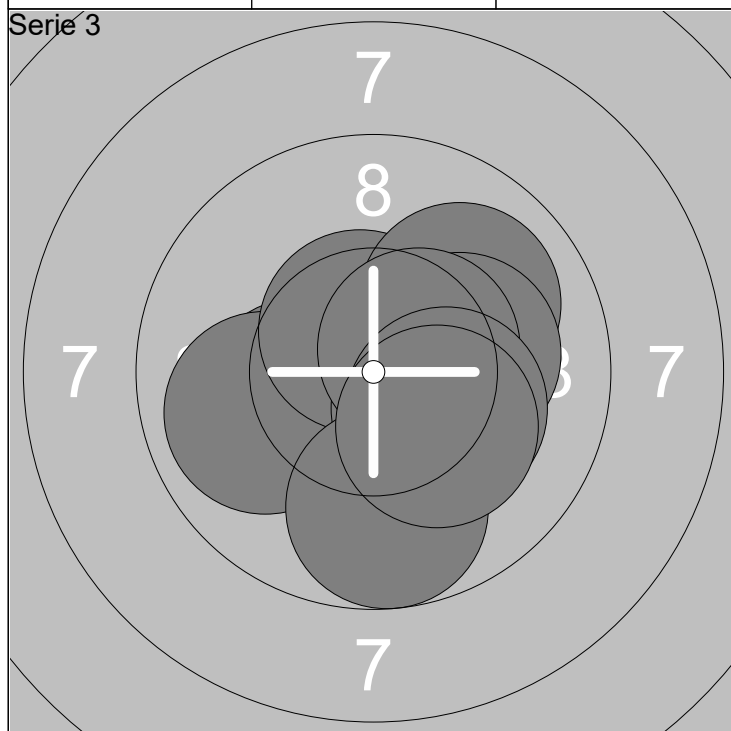

21: 10.3x ↙	26: 10.3x ↘	Serie	101.9
22: 9.9 ↙	27: 9.7 ↓		
23: 10.6x ↗	28: 10.5x ↗	Total	309.3
24: 10.0 ↗	29: 10.2x ↘		
25: 10.2x →	30: 10.2x ↘		

31: 10.6x ↙	36: 10.8x ↗	Serie	104.6
32: 10.4x ↖	37: 10.8x ↙		
33: 10.3x ↗	38: 10.1 ↙	Total	413.9
34: 10.7x ↗	39: 10.2x ↗		
35: 10.4x ↗	40: 10.3x ↗		

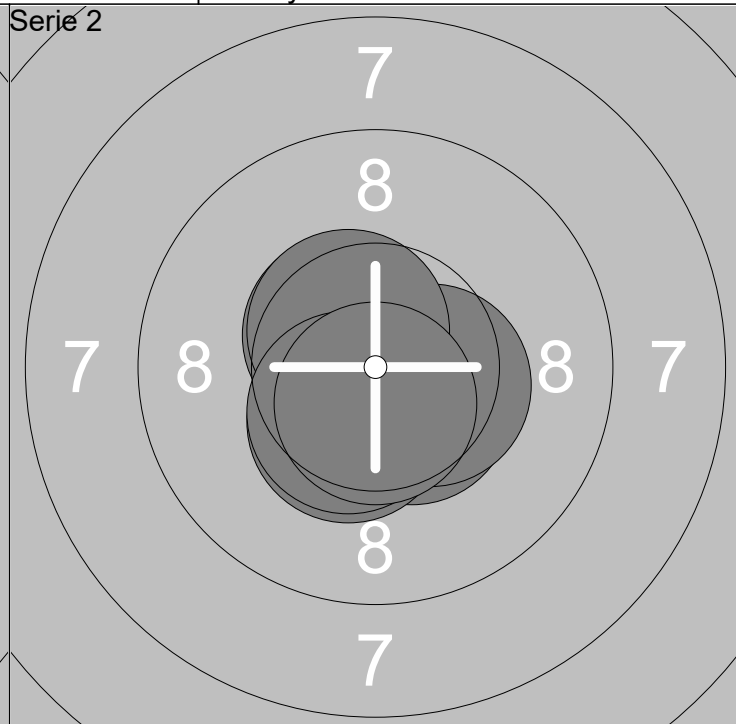
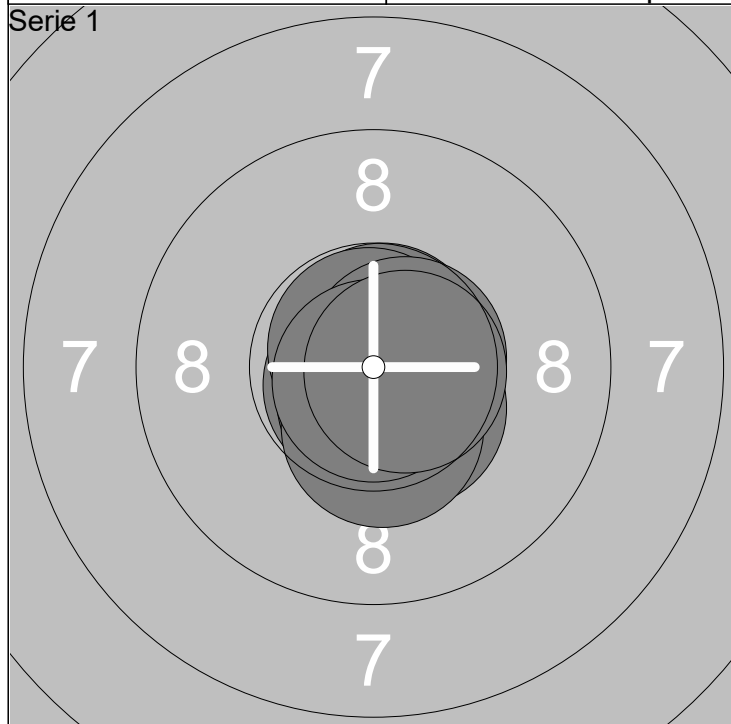

1: 10.8x ↘	6: 10.8x ↗	Serie	106.9
2: 10.7x ↗	7: 10.7x →		
3: 10.8x ↘	8: 10.4x ↓	Total	106.9
4: 10.7x ↓	9: 10.8x ↓		
5: 10.5x ↘	10: 10.7x →		

11: 10.5x ↘	16: 10.4x →	Serie	105.8
12: 10.6x ↓	17: 10.5x ↗		
13: 10.9x ↘	18: 10.4x ↓	Total	212.7
14: 10.6x ↗	19: 10.5x ↓		
15: 10.8x ↗	20: 10.6x ↓		

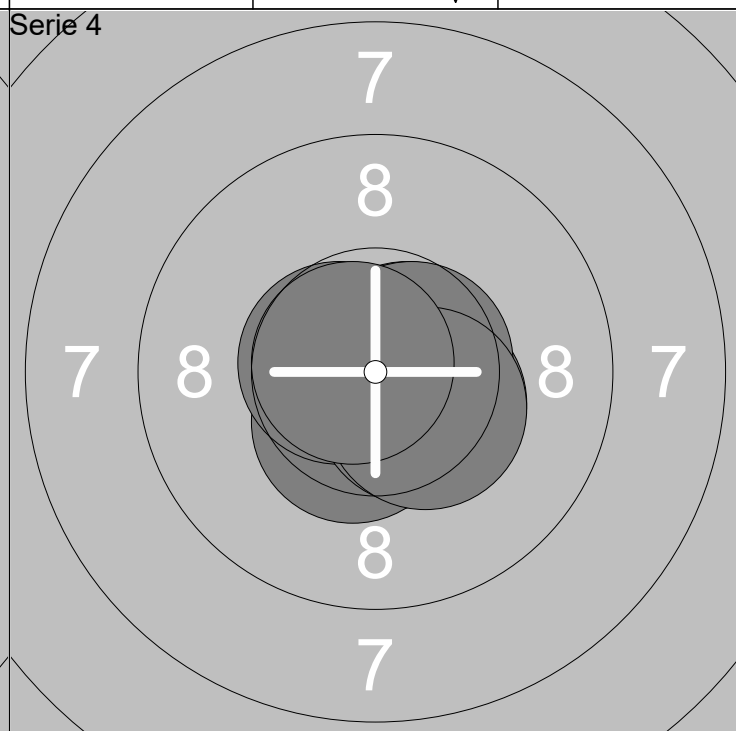
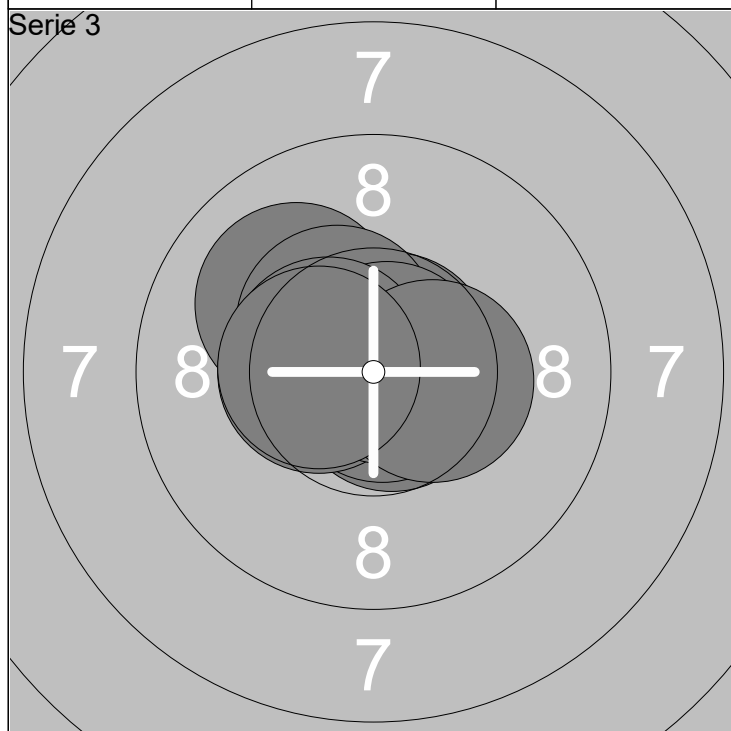

21: 10.7x ↗	26: 10.5x ←	Serie	105.3
22: 10.0 ↗	27: 10.8x ↗		
23: 10.4x ↗	28: 10.5x ←	Total	318.0
24: 10.7x ↓	29: 10.4x →		
25: 10.8x ↓	30: 10.5x ←		

31: 10.9x →	36: 10.5x ↘	Serie	105.8
32: 10.6x ↓	37: 10.6x →		
33: 10.5x ↘	38: 10.6x →	Total	423.8
34: 10.6x ←	39: 10.4x ↓		
35: 10.4x ↘	40: 10.7x ↗		

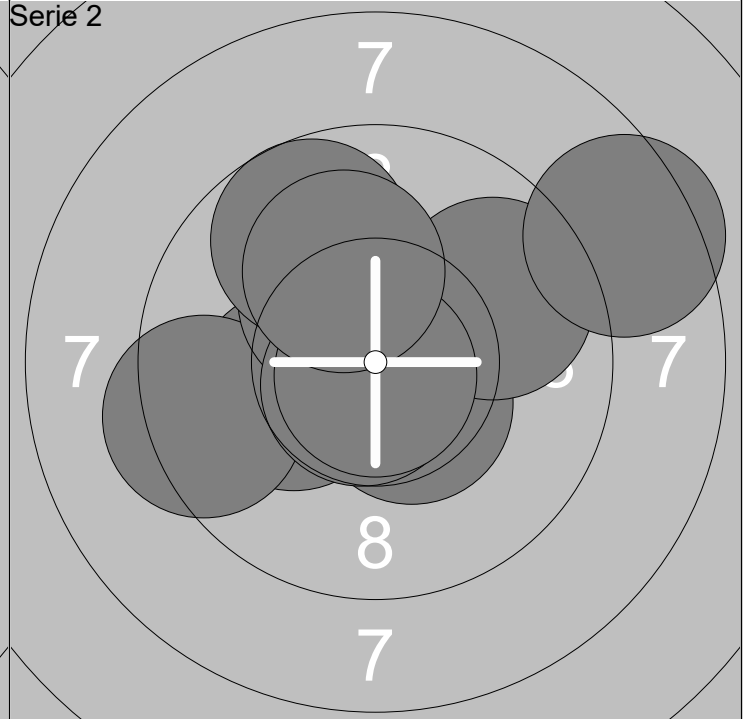
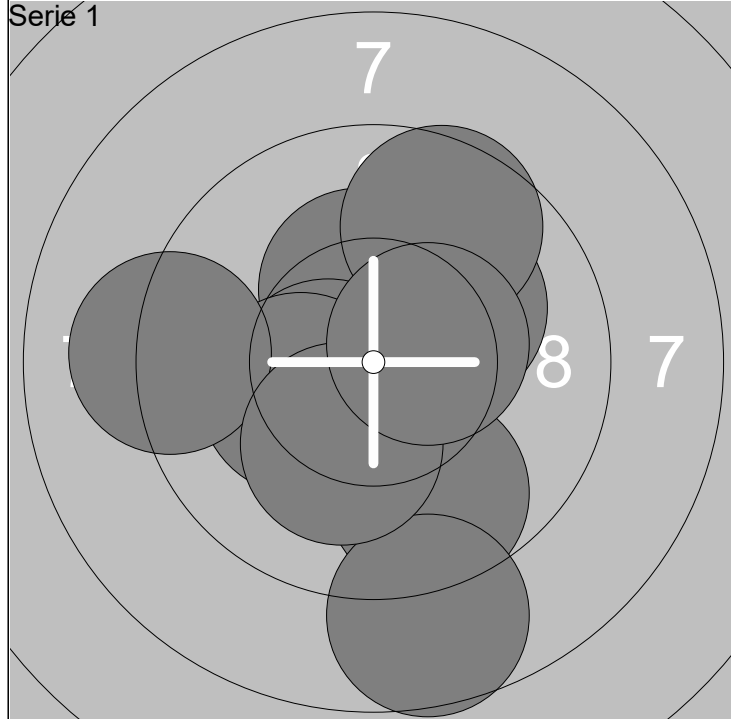

1: 10.1 ↗	6: 9.7 ↓	Serie	98.8
2: 10.3x ↑	7: 8.7 ↓		
3: 10.5x ←	8: 10.2x ↓	Total	98.8
4: 10.2x ←	9: 9.6 ↗		
5: 9.1 ←	10: 10.4x →		

11: 10.2x ←	16: 10.7x ↓	Serie	99.9
12: 10.4x ↓	17: 9.7 ↗		
13: 9.4 ←	18: 10.8x ↓	Total	198.7
14: 9.8 ↗	19: 8.5 ↗		
15: 10.3x ↗	20: 10.1 ↑		

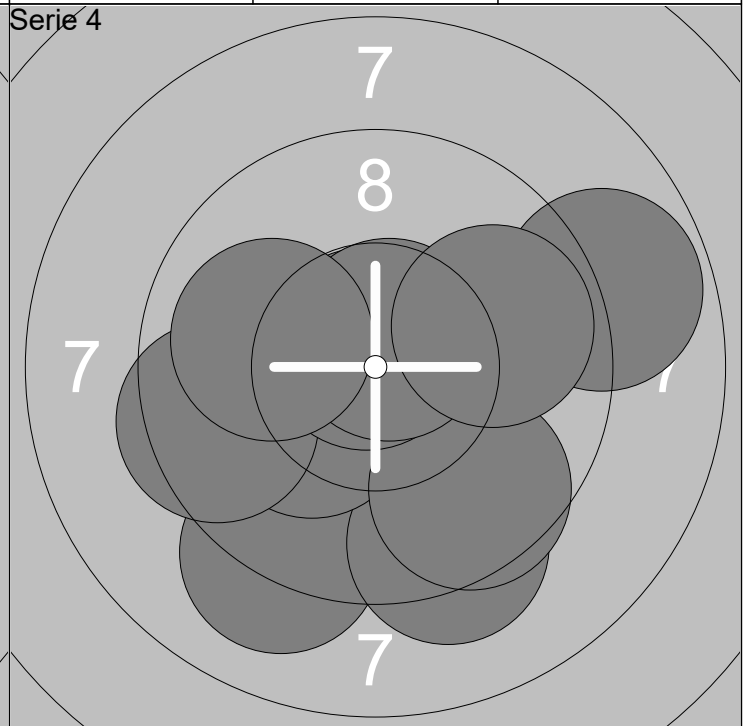
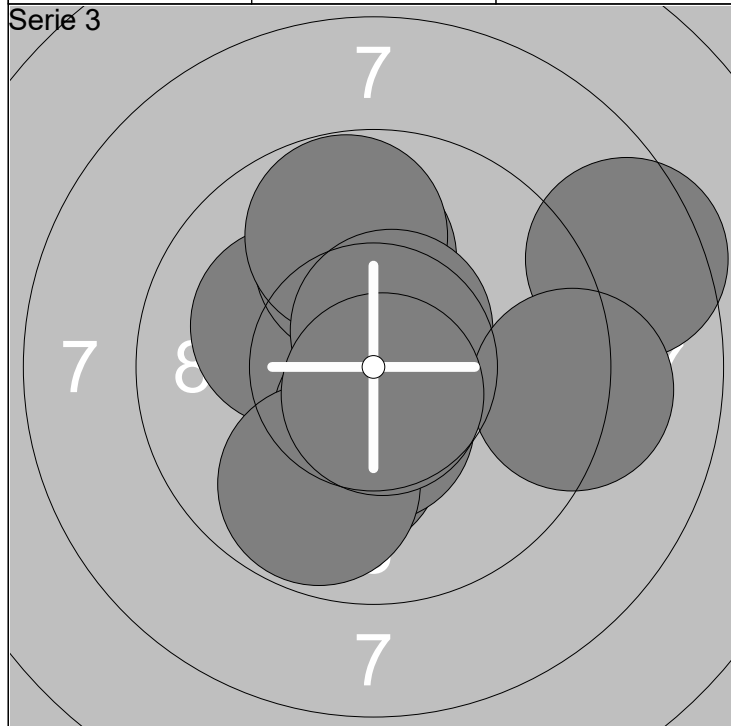

21: 10.2x ↓	26: 10.6x ↗	Serie	99.5
22: 8.5 ↗	27: 10.5x ↓		
23: 10.2x ←	28: 9.8 ↓	Total	298.2
24: 10.0 ↑	29: 9.2 →		
25: 9.8 ↑	30: 10.7x ↓		

31: 9.1 ↓	36: 10.8x ↗	Serie	97.9
32: 9.3 ↓	37: 8.8 →		
33: 10.3x ←	38: 10.7x ↗	Total	396.1
34: 9.6 ↓	39: 9.8 →		
35: 9.5 ←	40: 10.0 ←		

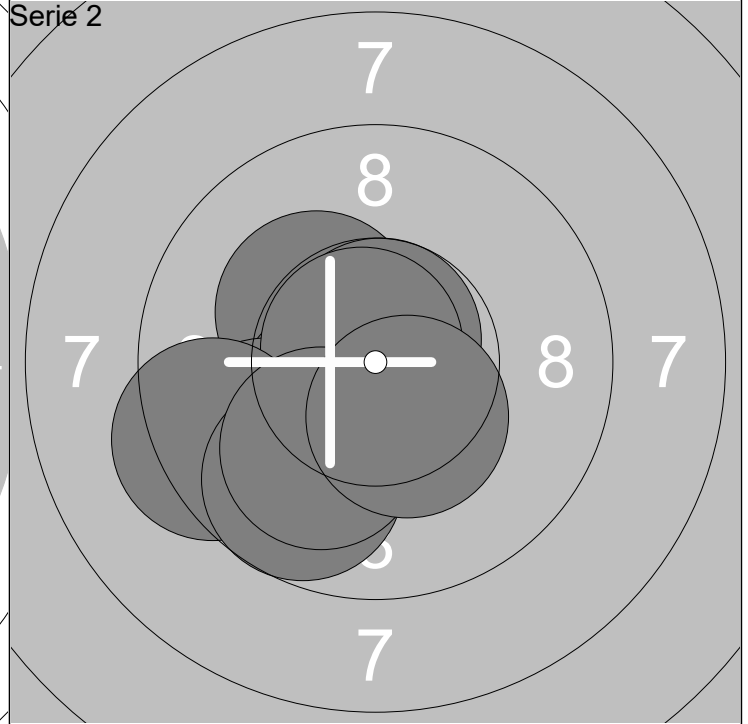
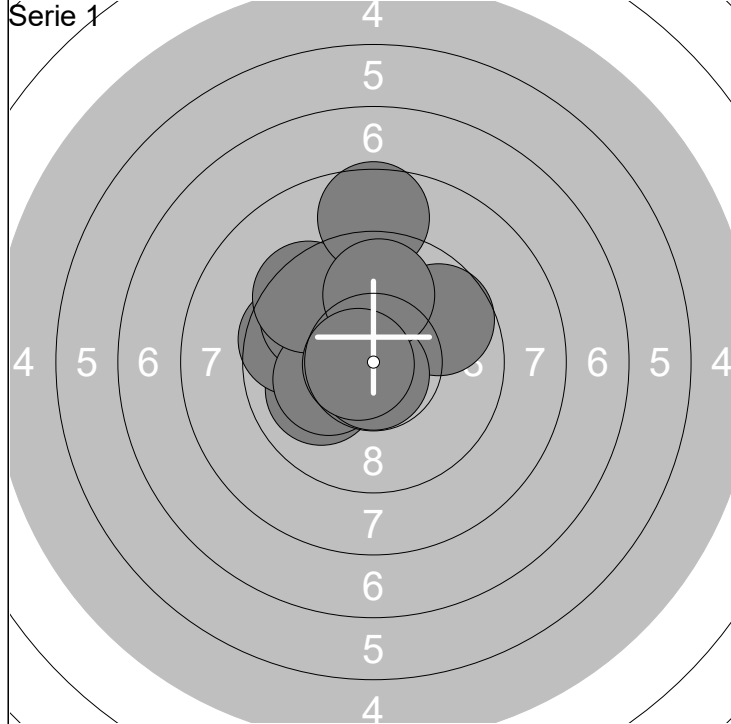

1: 10.0 ↙	6: 8.6 ↑	Serie	98.8
2: 9.6 ↙	7: 9.7 ↗		Total
3: 9.8 ↗	8: 10.8x ↓		
4: 10.2x ↙	9: 9.9 ↑		
5: 9.5 ↖	10: 10.7x ←		

11: 10.3x ↖	16: 10.8x ↖	Serie	102.1
12: 10.5x ↙	17: 9.4 ↙		Total
13: 10.3x ↓	18: 9.7 ↓		
14: 10.8x ↑	19: 10.1 ↓		
15: 9.8 ↙	20: 10.4x ↓		

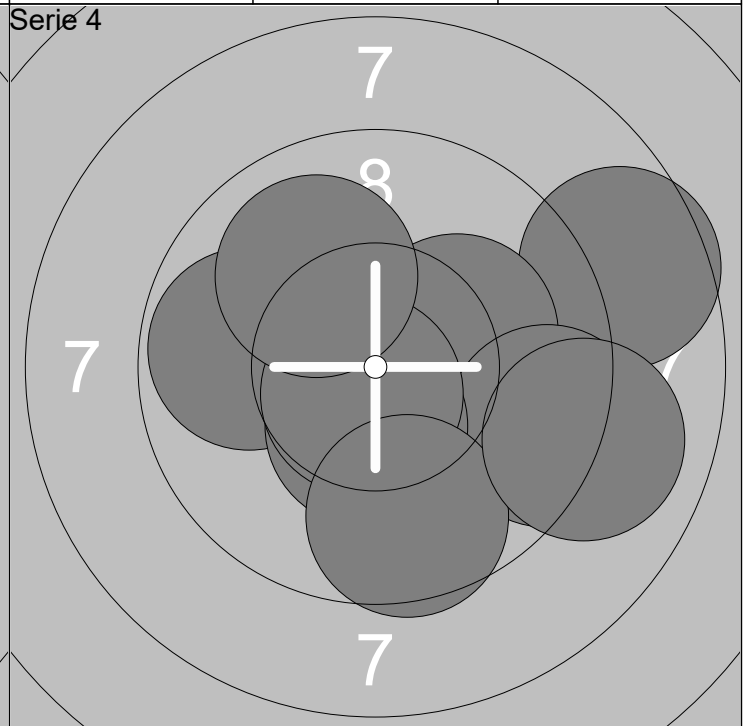
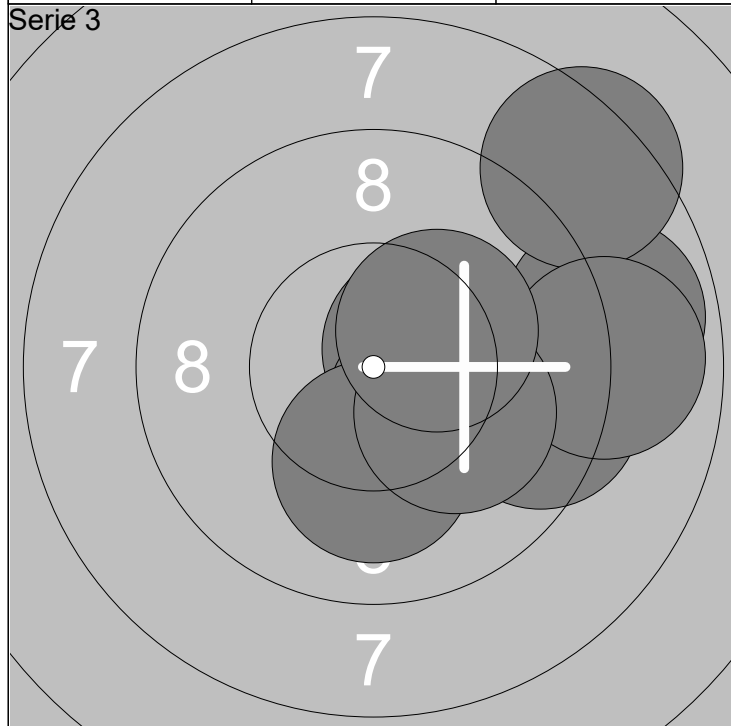

21: 10.5x ↗	26: 9.4 →	Serie	97.2
22: 10.3x →	27: 10.1 ↓		Total
23: 8.9 →	28: 8.9 →		
24: 10.3x ↘	29: 10.1 ↘		
25: 8.4 ↗	30: 10.3x ↗		

31: 8.6 ↗	36: 10.4x ↓	Serie	97.8
32: 10.2x ↙	37: 10.7x ↓		Total
33: 9.8 ←	38: 9.6 ↓		
34: 10.2x ↗	39: 9.0 →		
35: 9.3 →	40: 10.0 ↗		

Skjutlag

Tavla

2

5

Thomas Jonsson

Rottne Industri Cup 2019

Söraby Skytteförening

Ösm

26.10.2019

Rottne Industri Cup 2019

Söraby SKF

Serie 1

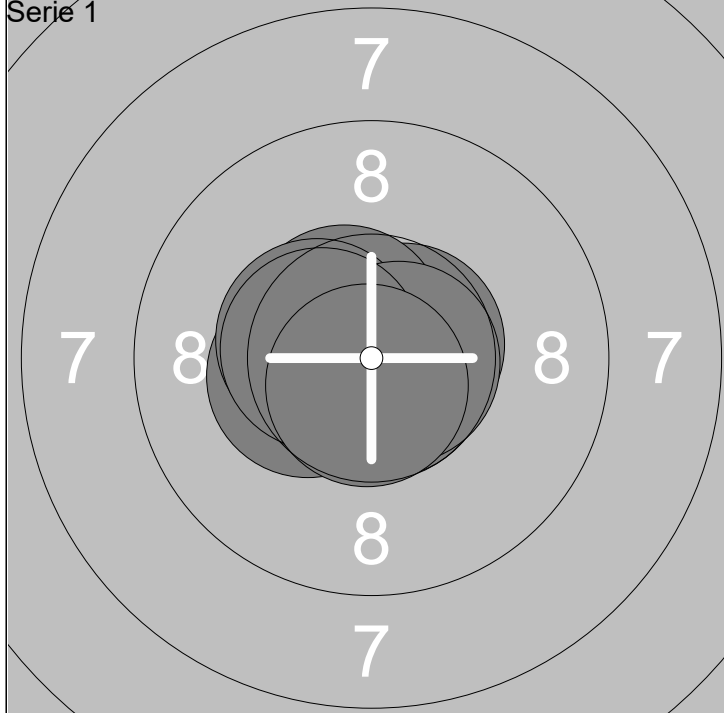

Serie 2

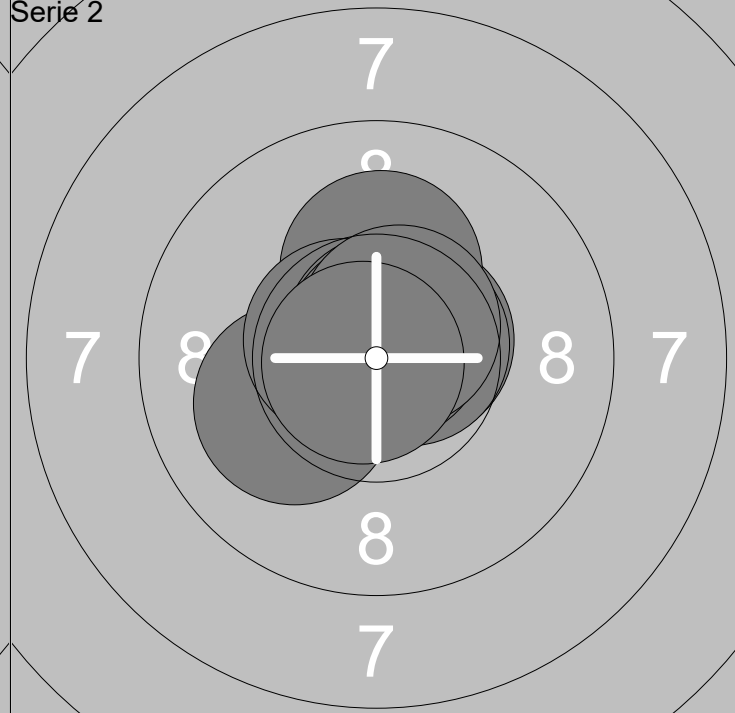

1: 10.5x ←

6: 10.7x ←

2: 10.7x ↘

7: 10.4x ←

3: 10.6x →

8: 10.7x →

4: 10.4x ←

9: 10.5x ←

5: 10.6x ↖

10: 10.7x ↓

Serie 105.8

Total 105.8

11: 10.8x ↖

16: 10.6x ↖

12: 10.1 ←

17: 10.7x ↗

13: 10.6x →

18: 10.8x ↗

14: 10.2x ↑

19: 10.6x ↗

15: 10.6x →

20: 10.8x ←

Serie 105.8

Total 211.6

Serie 3

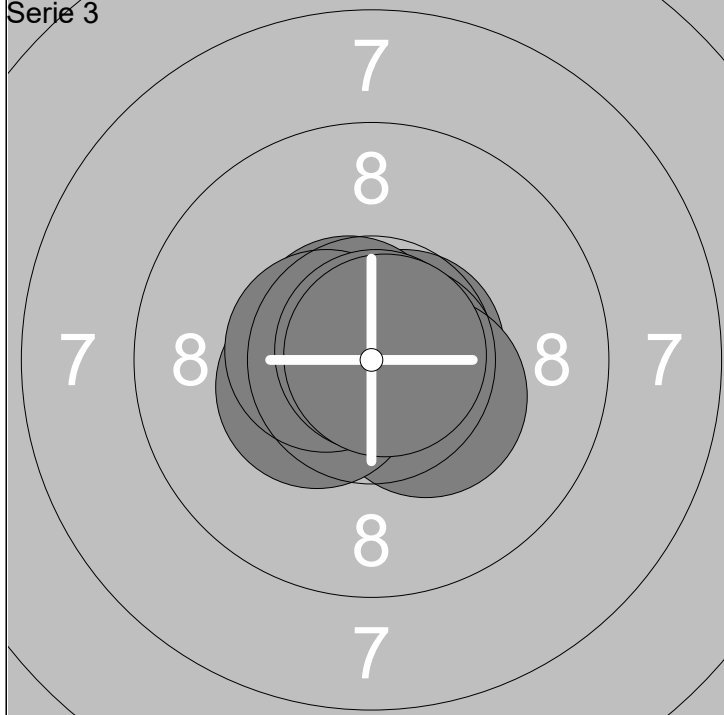

Serie 4

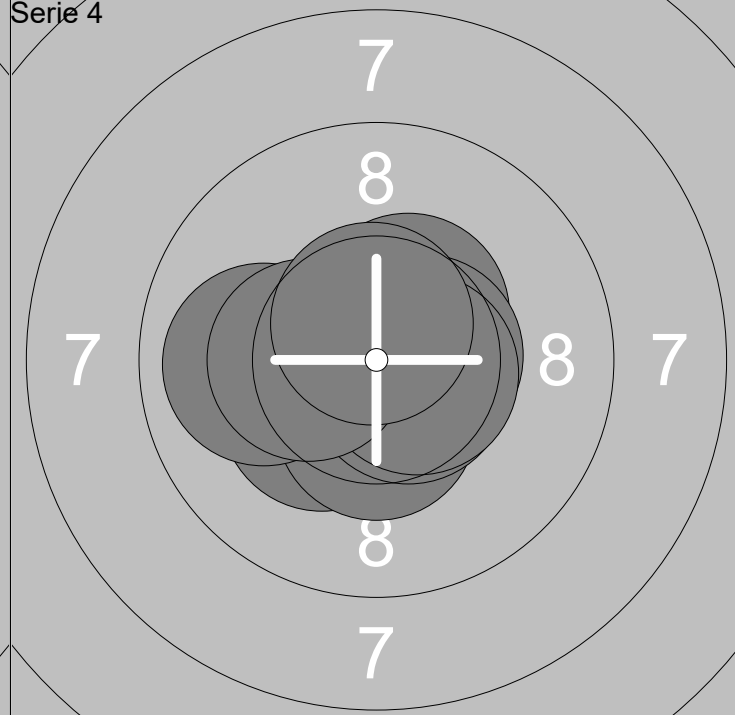

21: 10.5x ←

26: 10.4x ↘

22: 10.8x ←

27: 10.4x ←

23: 10.7x →

28: 10.5x ←

24: 10.7x ↖

29: 10.9x ↗

25: 10.7x →

30: 10.8x →

Serie 106.4

Total 318.0

31: 10.5x ↗

36: 10.6x ↘

32: 10.3x ←

37: 9.9 ←

33: 10.7x ↘

38: 10.6x →

34: 10.6x →

39: 10.3x ←

35: 10.4x ↓

40: 10.6x ↑

Serie 104.5

Total 422.5

Rottne Industri Cup 2019

Serie 1

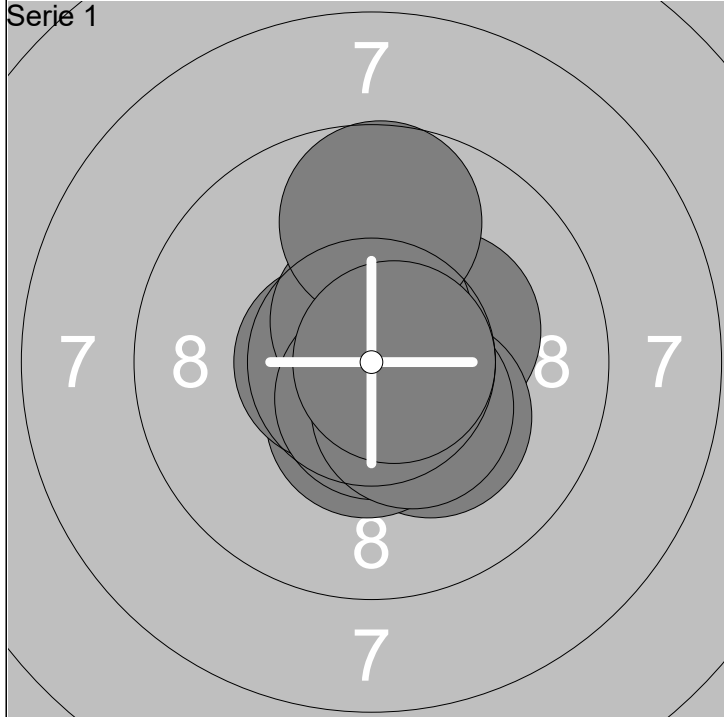

Serie 2

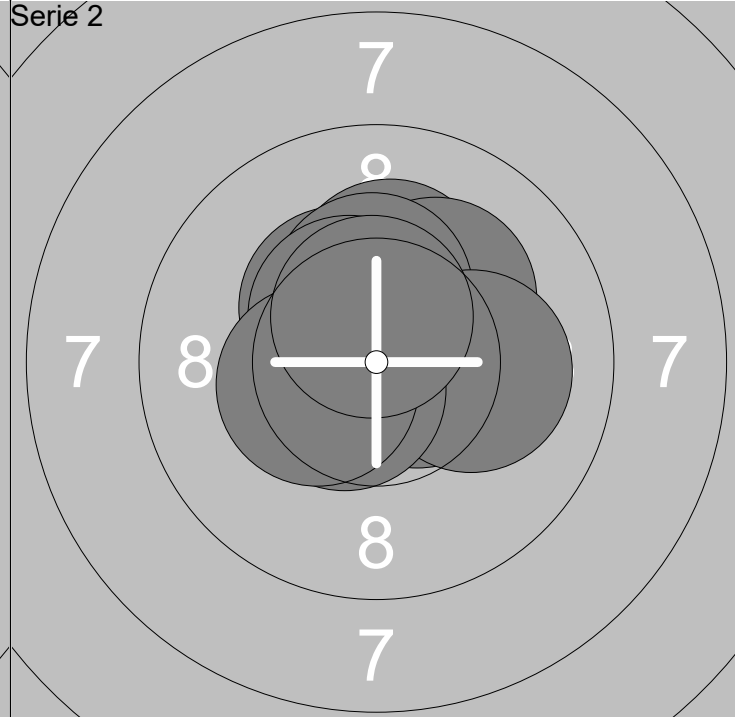

1: 10.3x →  
2: 10.3x ↘  
3: 10.5x ↓  
4: 10.7x ↘  
5: 10.6x ←

6: 10.6x ↑  
7: 10.6x ↓  
8: 9.7 ↑  
9: 10.4x ↘  
10: 10.7x →

Serie 104.4

Total 104.4

11: 10.2x ↑  
12: 10.6x →  
13: 10.4x ↗  
14: 10.2x ↗  
15: 10.3x ↑

16: 10.5x ↗  
17: 10.1 →  
18: 10.6x ↘  
19: 10.4x ←  
20: 10.6x ↑

Serie 103.9

Total 208.3

Serie 3

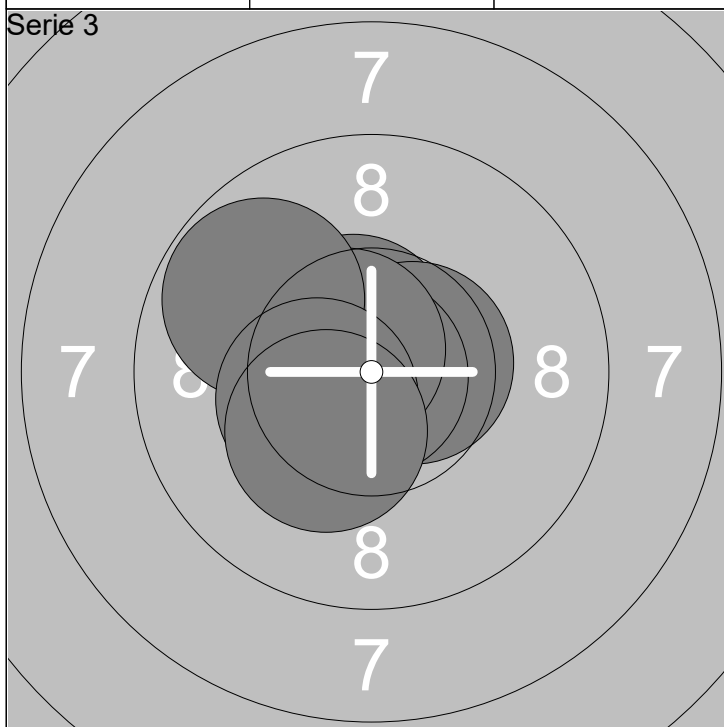

Serie 4

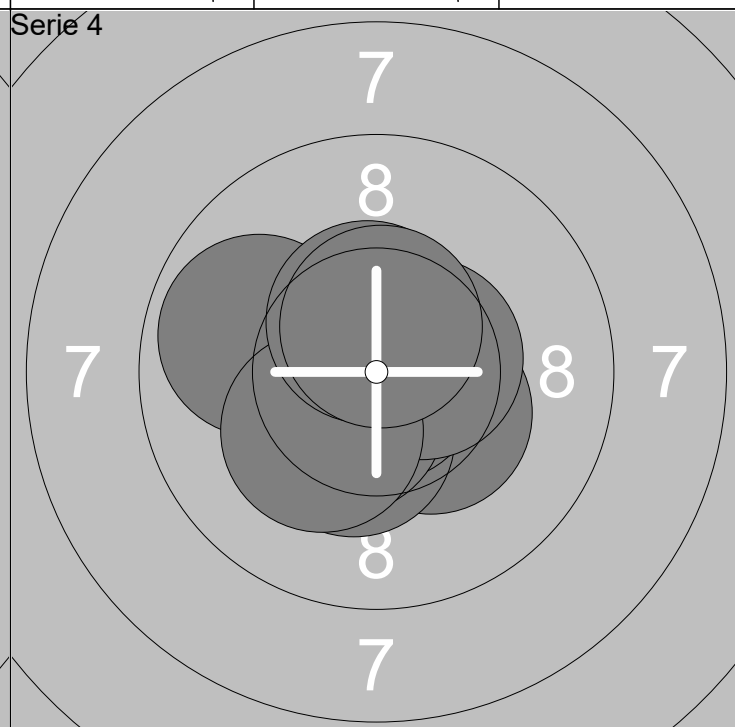

21: 10.6x ↗  
22: 10.9x ↘  
23: 10.6x →  
24: 10.5x ←  
25: 10.6x ←

26: 10.9x ↘  
27: 10.6x ↘  
28: 9.8 ↘  
29: 10.4x ←  
30: 10.3x ↘

Serie 105.2

Total 313.5

31: 10.3x ↘  
32: 10.4x ↓  
33: 9.8 ←  
34: 10.9x ↓  
35: 10.5x ↘

36: 10.8x ↗  
37: 10.5x →  
38: 10.2x ↘  
39: 10.5x ↑  
40: 10.5x ↑

Serie 104.4

Total 417.9



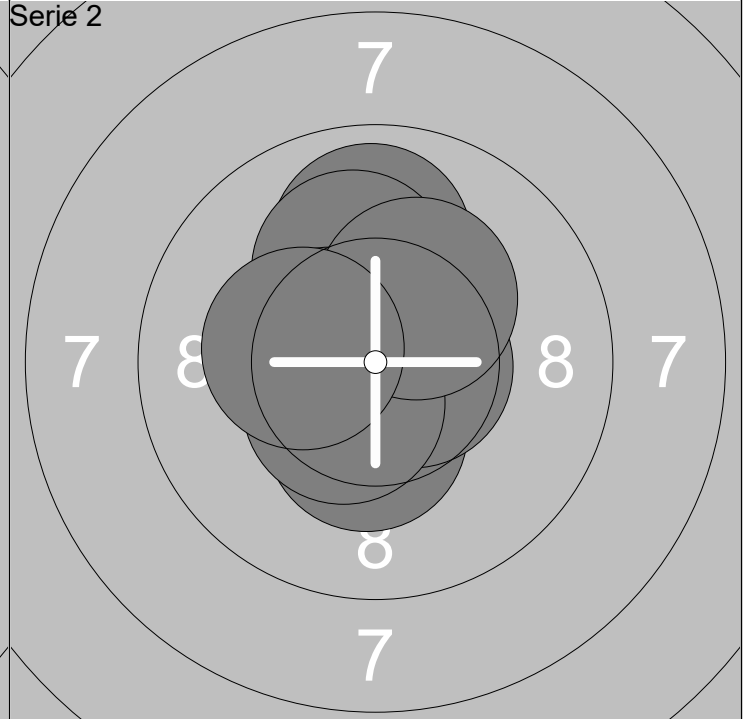
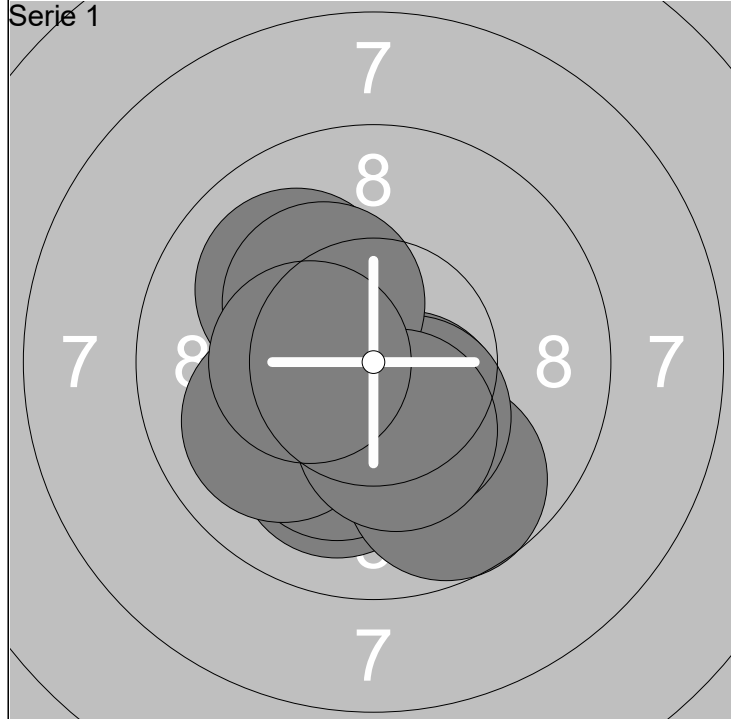

1: 10.1 ↘	6: 9.8 ↘	Serie	101.9
2: 10.0 ↗	7: 10.4x ↘		
3: 10.2x ↘	8: 10.3x ↗	Total	101.9
4: 10.4x ↘	9: 10.3x ↘		
5: 10.0 ↙	10: 10.4x ←		

11: 10.8x →	16: 10.6x →	Serie	103.9
12: 10.5x ↗	17: 10.5x ←		
13: 9.9 ↗	18: 10.5x ↘	Total	205.8
14: 10.1 ↗	19: 10.3x ↗		
15: 10.4x ↘	20: 10.3x ←		

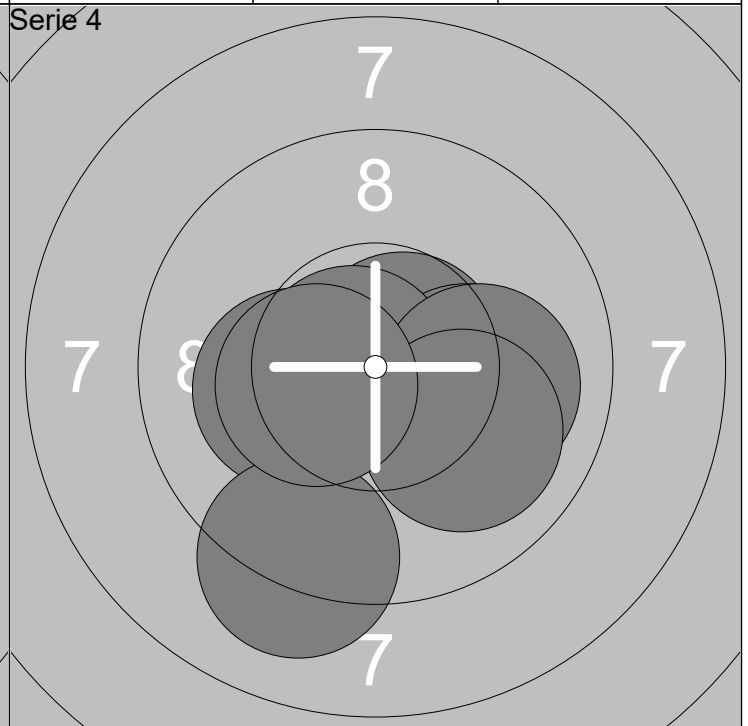
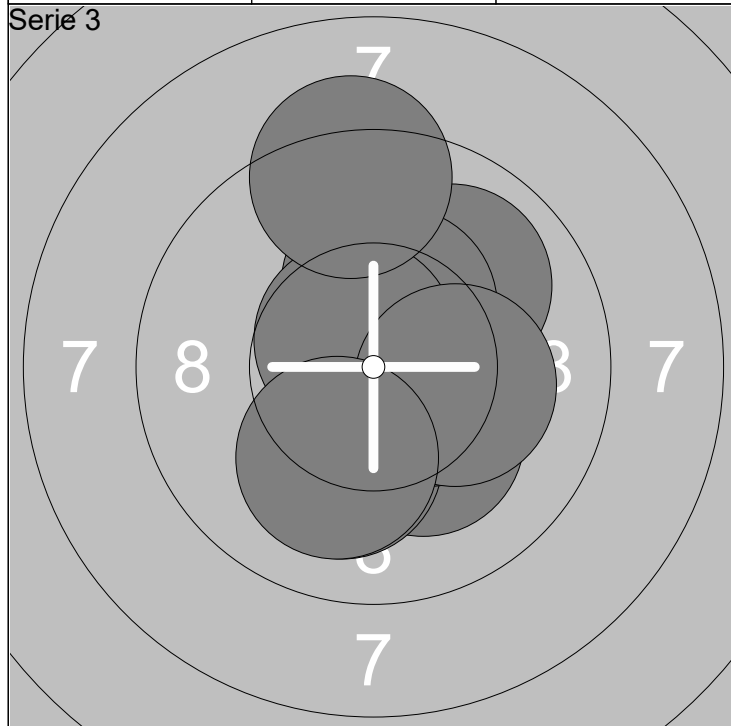

21: 10.2x ↘	26: 10.4x ↗	Serie	101.5
22: 10.1 ↘	27: 10.7x ↗		
23: 10.4x →	28: 10.2x →	Total	307.3
24: 10.2x ↗	29: 10.1 ↘		
25: 9.9 ↗	30: 9.3 ↗		

31: 10.6x →	36: 9.1 ↘	Serie	102.1
32: 10.2x ←	37: 10.8x ←		
33: 10.2x →	38: 10.0 →	Total	409.4
34: 10.7x ↗	39: 10.0 ↘		
35: 10.1 →	40: 10.4x ←		

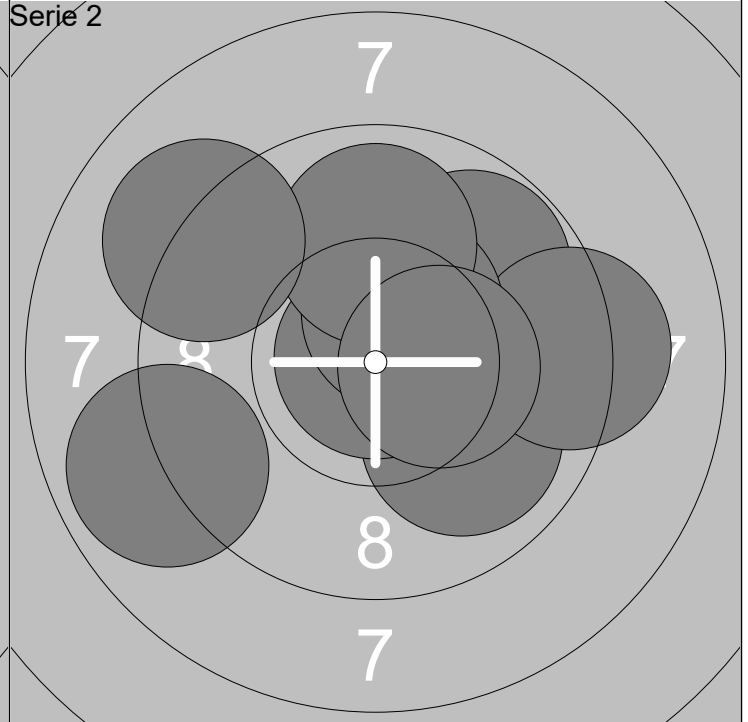
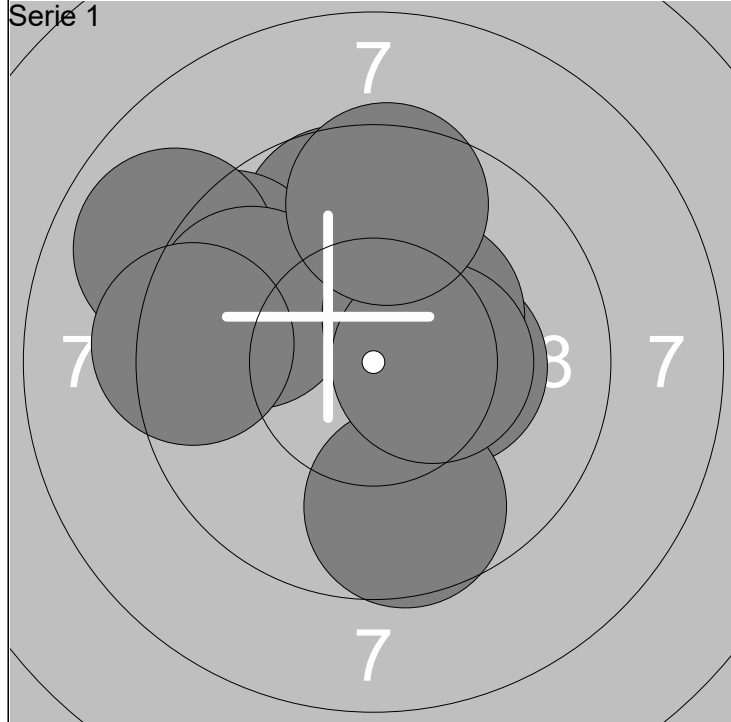

1: 9.7 ↑	6: 10.3x →	Serie	97.3
2: 9.4 ↘	7: 9.6 ↓		
3: 8.9 ↗	8: 10.4x ↗	Total	97.3
4: 9.8 ↖	9: 10.4x →		
5: 9.3 ←	10: 9.5 ↑		

11: 8.9 ↙	16: 10.9x ↑	Serie	98.9
12: 10.4x ↗	17: 10.4x ↗		
13: 9.9 ↘	18: 9.9 ↑	Total	196.2
14: 9.8 ↗	19: 10.4x →		
15: 9.2 →	20: 9.1 ↖		

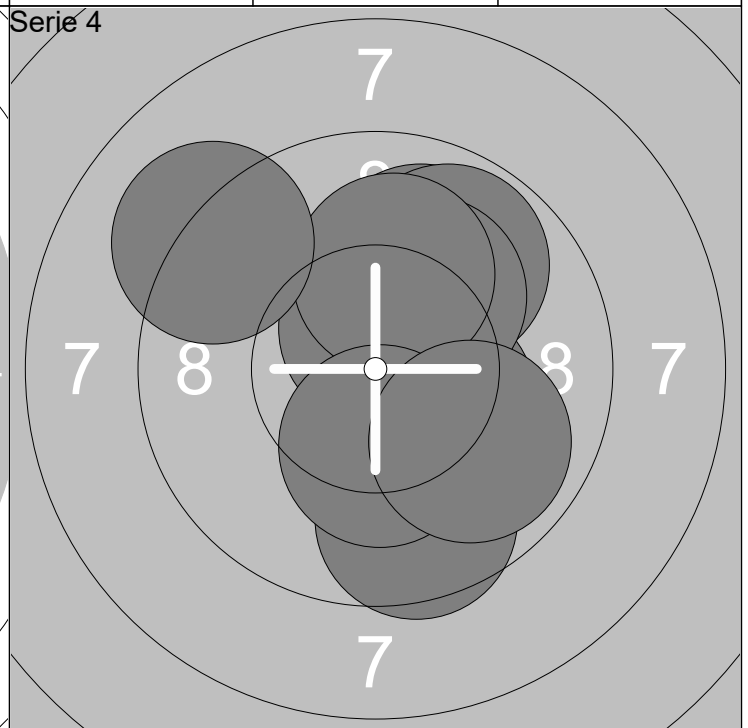
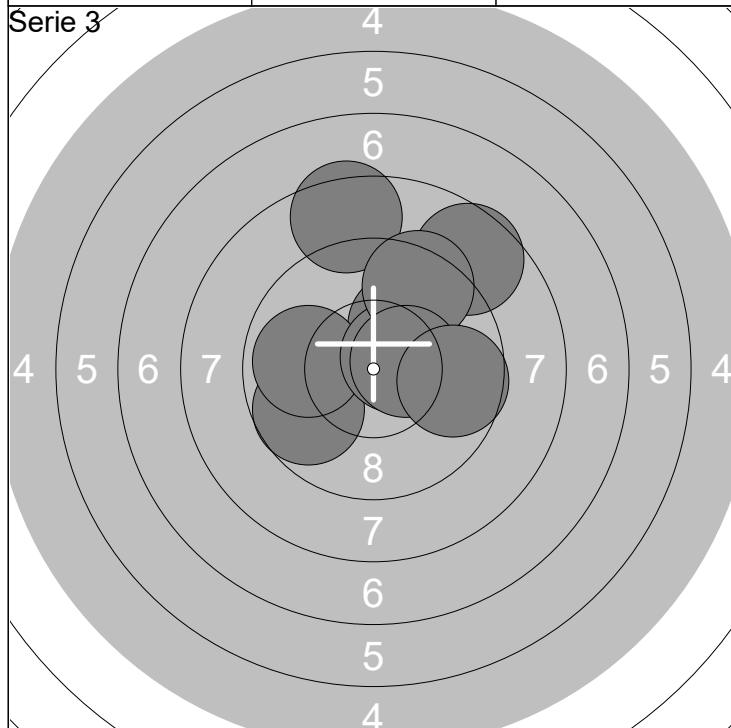

21: 10.1 ↗	26: 10.5x ↗	Serie	97.3
22: 8.5 ↑	27: 8.6 ↗		
23: 9.7 ↙	28: 9.5 ↗	Total	293.5
24: 10.4x ↗	29: 10.4x →		
25: 9.9 ←	30: 9.7 →		

31: 10.0 ↑	36: 10.1 ↑	Serie	100.0
32: 10.6x ↑	37: 9.1 ↖		
33: 9.8 ↗	38: 9.6 ↓	Total	393.5
34: 10.4x ↘	39: 10.3x ↓		
35: 10.2x ↗	40: 9.9 ↘		

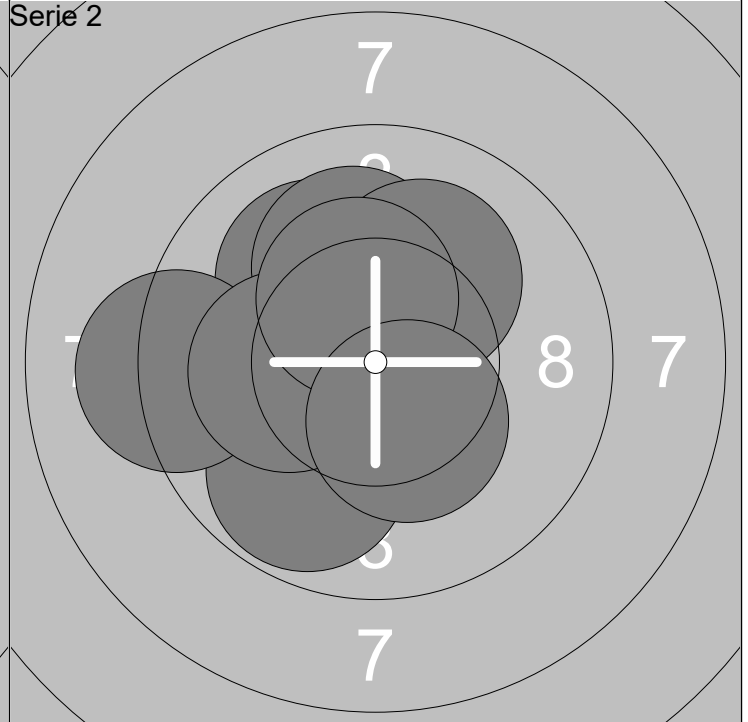
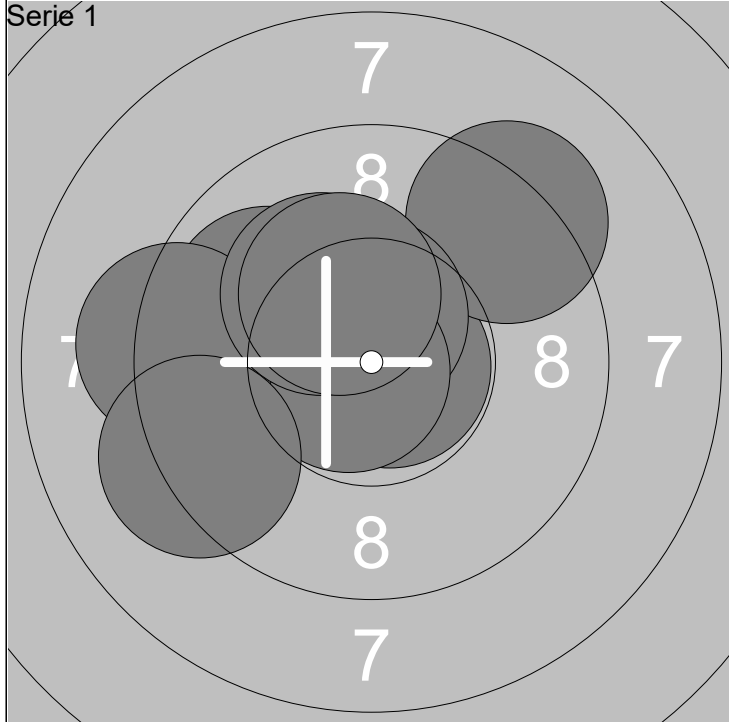

1: 10.8x →	6: 10.7x ←	Serie	100.5
2: 9.9 ↙	7: 9.2 ←		
3: 9.2 ↗	8: 10.2x ↗	Total	100.5
4: 10.5x ↖	9: 9.2 ↙		
5: 10.5x ↑	10: 10.3x ↗		

11: 10.1 ↖	16: 10.1 ↗	Serie	101.4
12: 9.8 ↘	17: 9.2 ←		
13: 10.6x ↗	18: 10.2x ←	Total	201.9
14: 10.1 ↑	19: 10.4x ↑		
15: 10.6x ↗	20: 10.3x ↘		

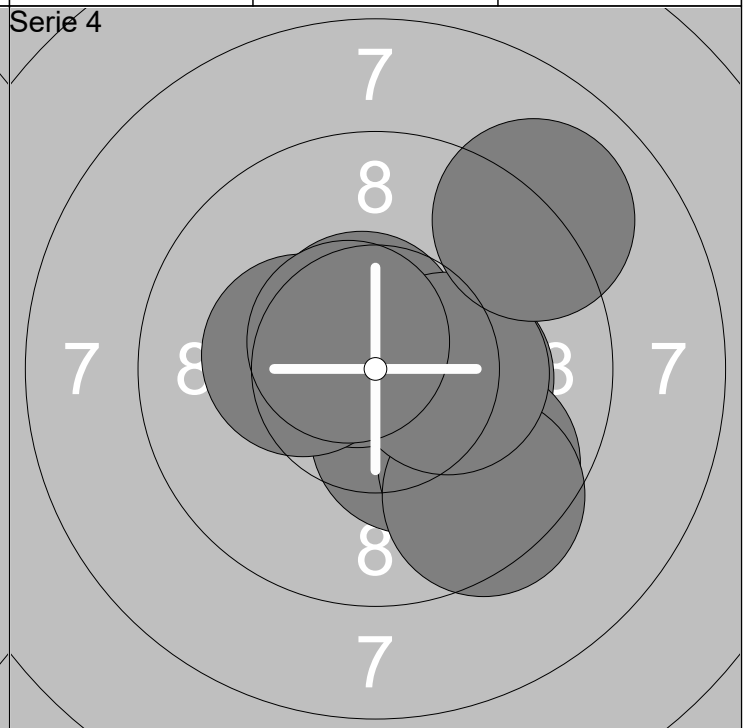
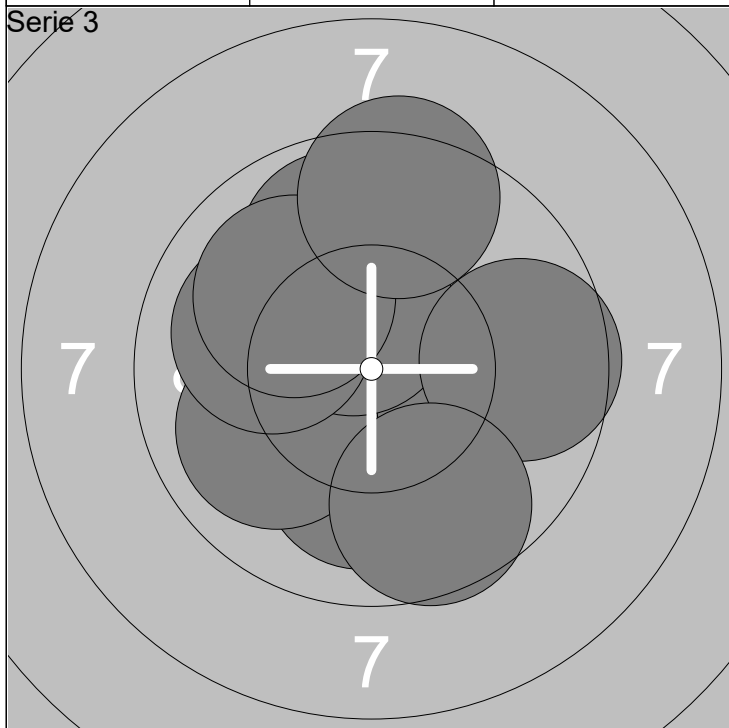

21: 10.1 ↓	26: 10.0 ←	Serie	99.7
22: 9.9 ↑	27: 9.6 →		
23: 10.7x ←	28: 10.0 ↗	Total	301.6
24: 10.0 ↙	29: 9.4 ↑		
25: 10.4x ↑	30: 9.6 ↓		

31: 10.3x ↘	36: 9.5 ↘	Serie	101.3
32: 10.3x →	37: 10.3x ←		
33: 10.7x ↗	38: 10.3x →	Total	402.9
34: 9.7 ↘	39: 10.6x ↗		
35: 10.6x ↗	40: 9.0 ↗		

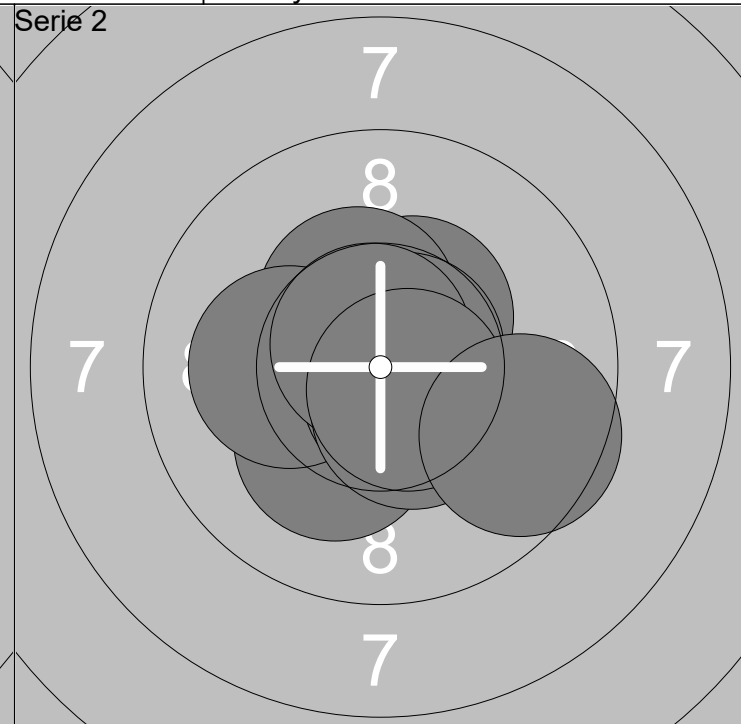
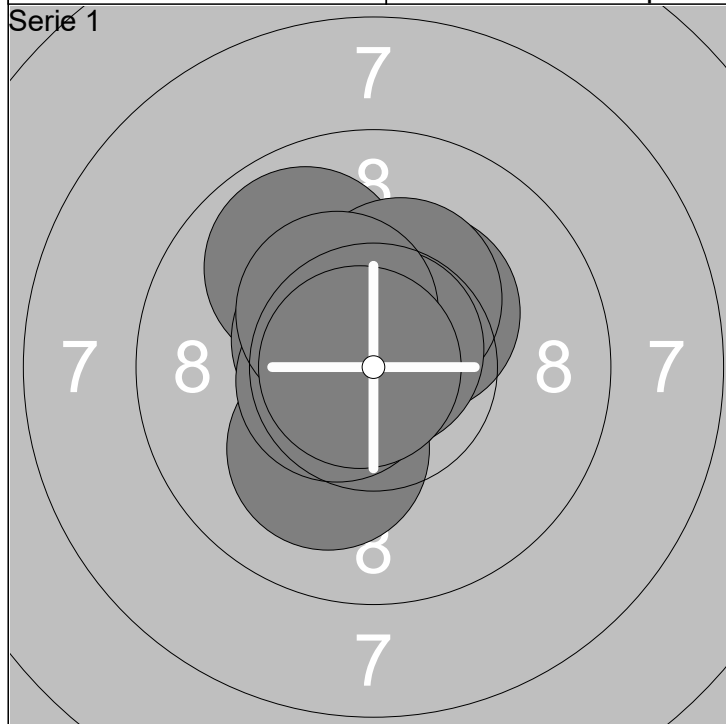

1: 10.3x ↗	6: 10.3x ↗	Serie	104.5
2: 10.8x ←	7: 10.8x ↗		
3: 9.9 ↗	8: 10.6x ←	Total	104.5
4: 10.1 ↘	9: 10.4x ↗		
5: 10.5x ↖	10: 10.8x ←		

11: 10.4x ↗	16: 10.7x ↗	Serie	104.1
12: 10.2x ↘	17: 10.7x ↗		
13: 10.4x ↗	18: 10.5x ↘	Total	208.6
14: 10.2x ←	19: 10.7x ↘		
15: 10.7x ↘	20: 9.6 ↘		

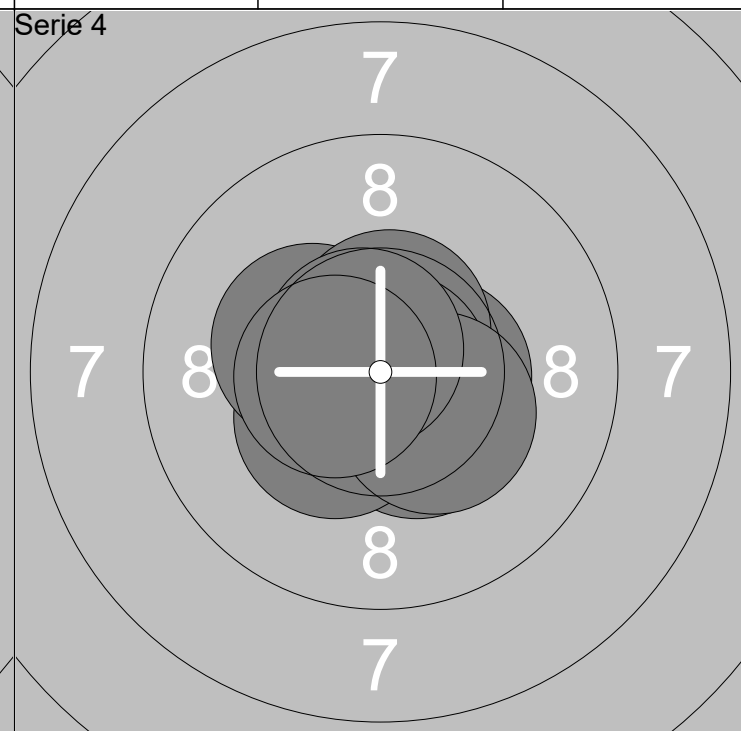
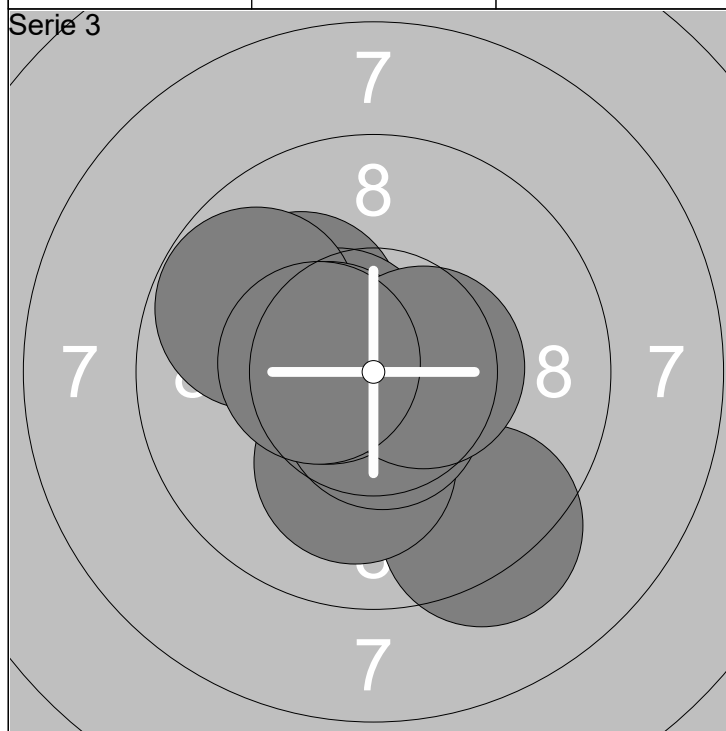

21: 10.7x ↘	26: 10.6x ↘	Serie	102.5
22: 10.1 ↗	27: 9.8 ↖		
23: 9.3 ↘	28: 10.5x ←	Total	311.1
24: 10.5x ↗	29: 10.5x →		
25: 10.1 ↘	30: 10.4x ←		

31: 10.4x ↘	36: 10.6x ↗	Serie	105.3
32: 10.5x →	37: 10.9x →		
33: 10.7x ↘	38: 10.3x ↘	Total	416.4
34: 10.4x ↘	39: 10.7x ↗		
35: 10.3x ←	40: 10.5x ←		

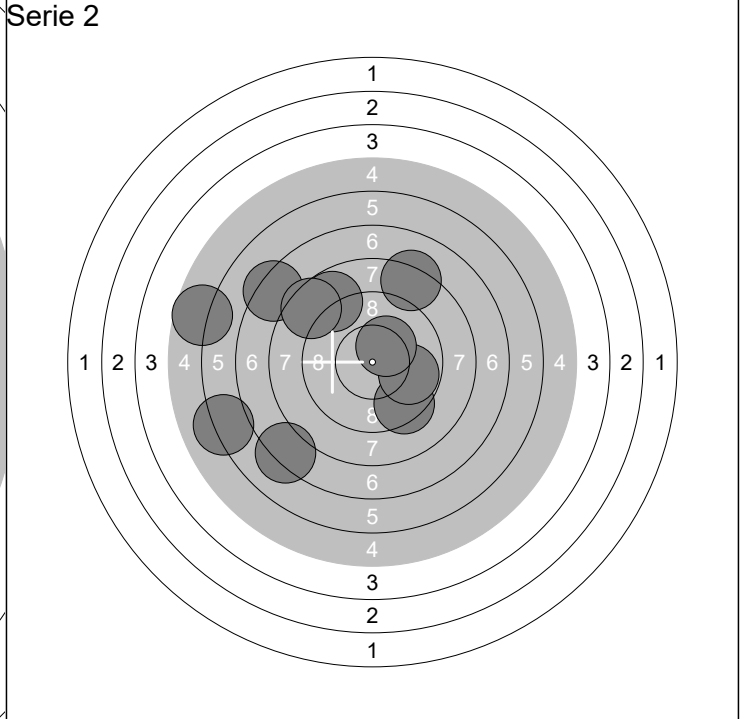
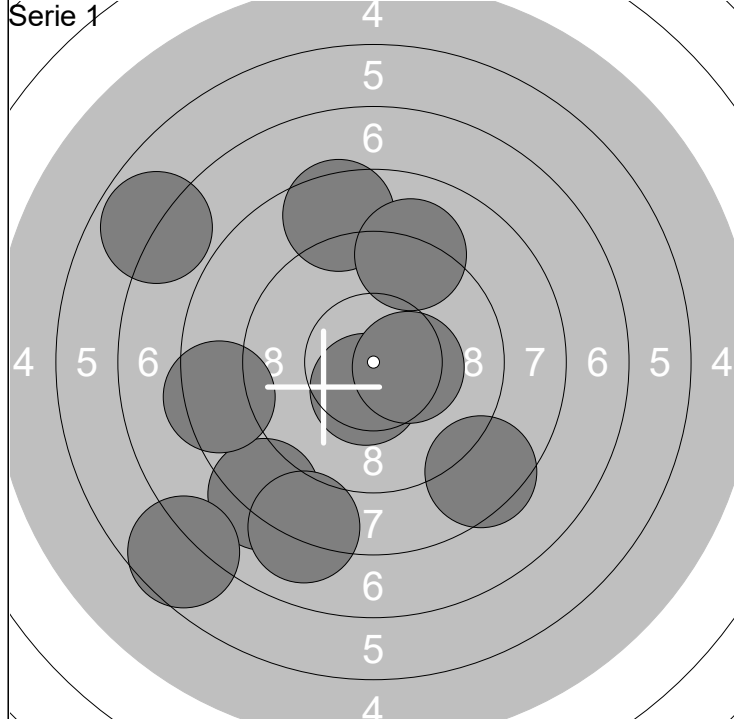

1: 6.9 ↖	6: 8.4 ←	Serie	85.2
2: 10.5x ↓	7: 8.5 ↘		
3: 8.5 ↑	8: 9.1 ↑	Total	85.2
4: 8.2 ↙	9: 6.6 ↘		
5: 8.1 ↓	10: 10.4x →		

11: 7.3 ↗	16: 8.2 ↗	Serie	81.3
12: 8.8 ↗	17: 7.2 ↘		
13: 8.5 ↗	18: 5.7 ←	Total	166.5
14: 9.4 ↘	19: 6.1 ←		
15: 9.8 →	20: 10.3x ↗		

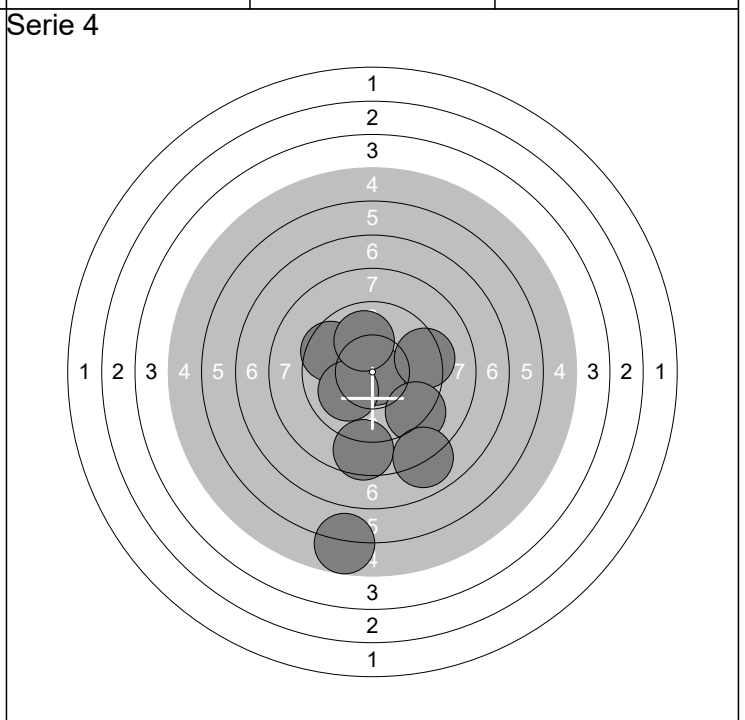
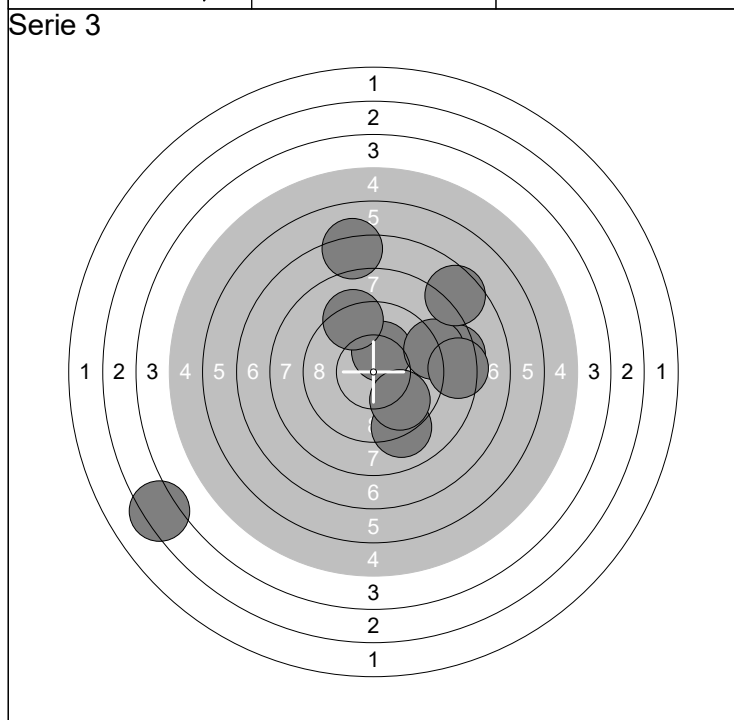

21: 9.1 ↓	26: 9.8 ↘	Serie	82.5
22: 10.3x ↑	27: 8.4 →		
23: 8.5 →	28: 7.6 ↗	Total	249.0
24: 9.0 →	29: 7.2 ↑		
25: 3.3 ↙	30: 9.3 ↑		

31: 10.1 ↖	36: 9.2 ↘	Serie	91.4
32: 10.8x ↘	37: 5.7 ↓		
33: 9.4 →	38: 8.6 ↓	Total	340.4
34: 9.6 ↖	39: 8.0 ↓		
35: 10.0 ↙	40: 10.0 ↑		

Serie 1

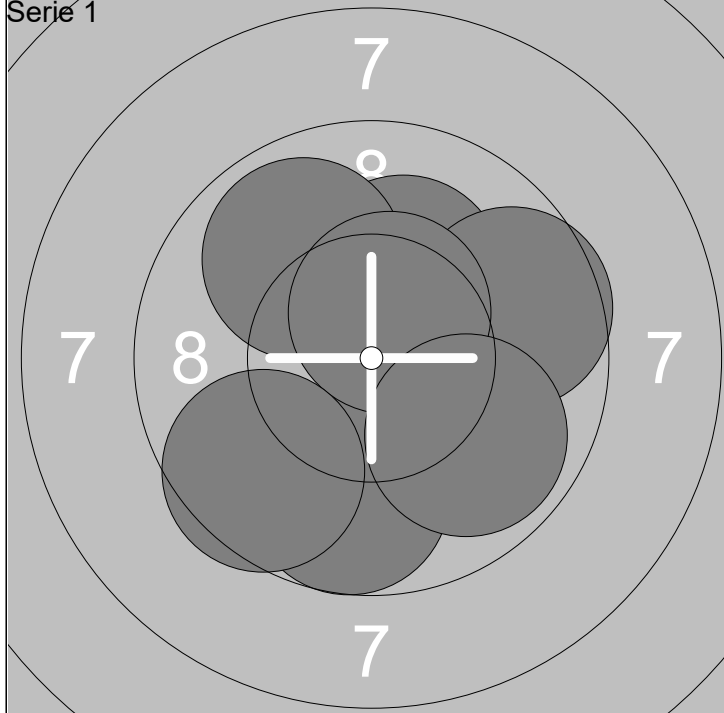

Serie 2

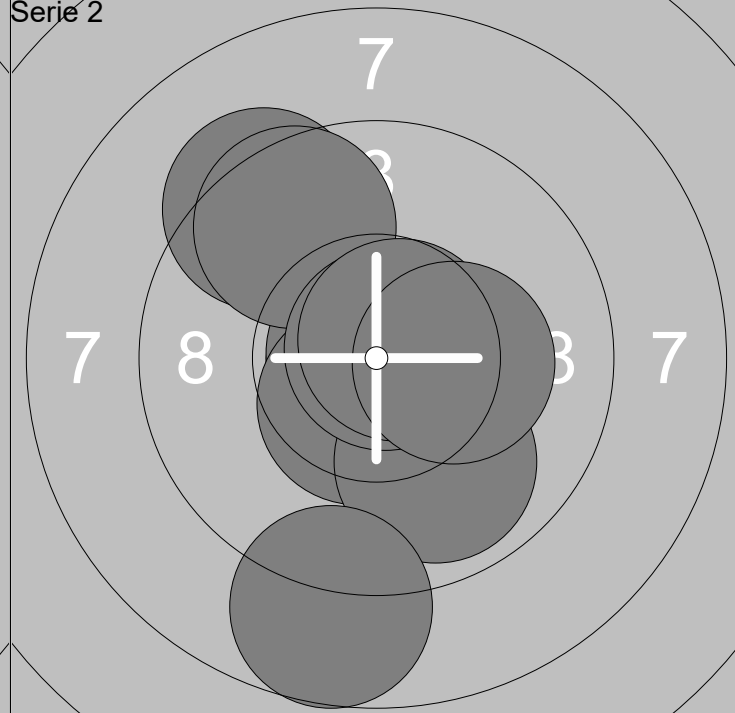

1:	10.2x	↗	6:	9.9	↖
2:	10.4x	↗	7:	9.7	→
3:	10.3x	→	8:	10.5x	↗
4:	9.7	↓	9:	9.9	↘
5:	10.2x	↗	10:	9.6	↘

Serie	100.4
Total	100.4

11:	10.9x	↖	16:	9.6	↖
12:	10.8x	↖	17:	10.8x	↗
13:	9.3	↗	18:	10.7x	↗
14:	10.5x	↓	19:	10.3x	→
15:	9.9	↓	20:	8.7	↓

Serie	101.5
Total	201.9

Serie 3

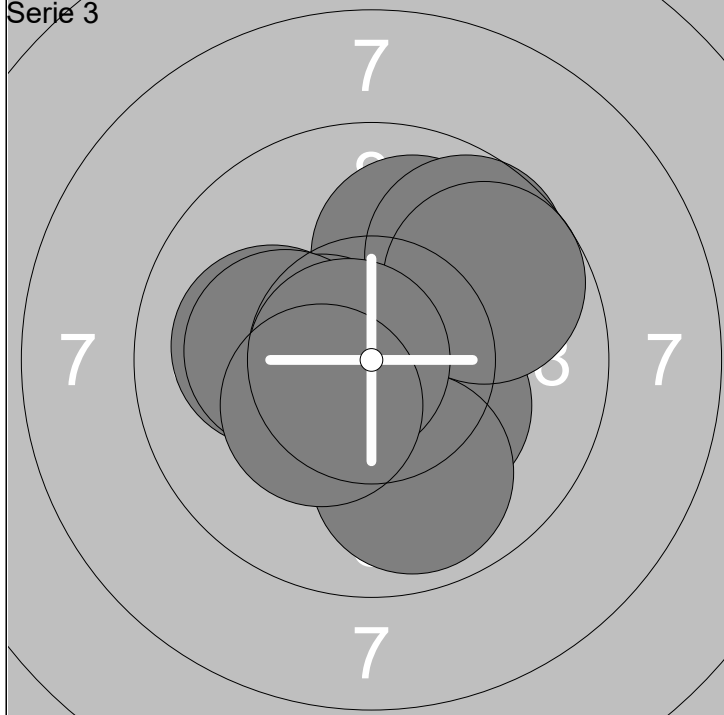

Serie 4

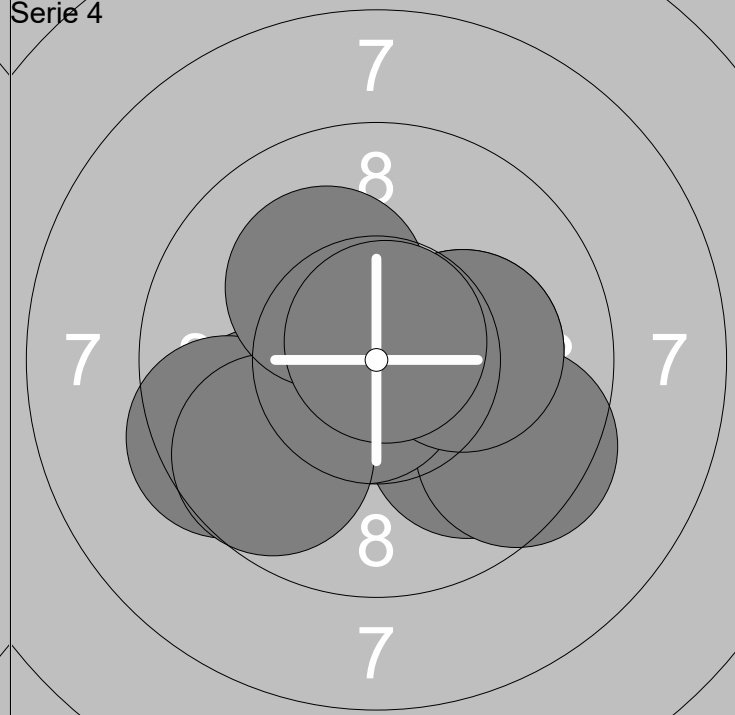

21:	10.0	↗	26:	10.0	↖
22:	10.3x	↘	27:	9.7	↗
23:	9.7	↗	28:	10.2x	↖
24:	9.9	↓	29:	10.7x	↖
25:	10.5x	↖	30:	10.4x	↘

Serie	101.4
Total	303.3

31:	9.9	↘	36:	9.5	↖
32:	10.2x	→	37:	9.7	↘
33:	9.5	↘	38:	10.2x	↗
34:	9.8	↖	39:	10.2x	→
35:	10.7x	↘	40:	10.8x	↗

Serie	100.5
Total	403.8

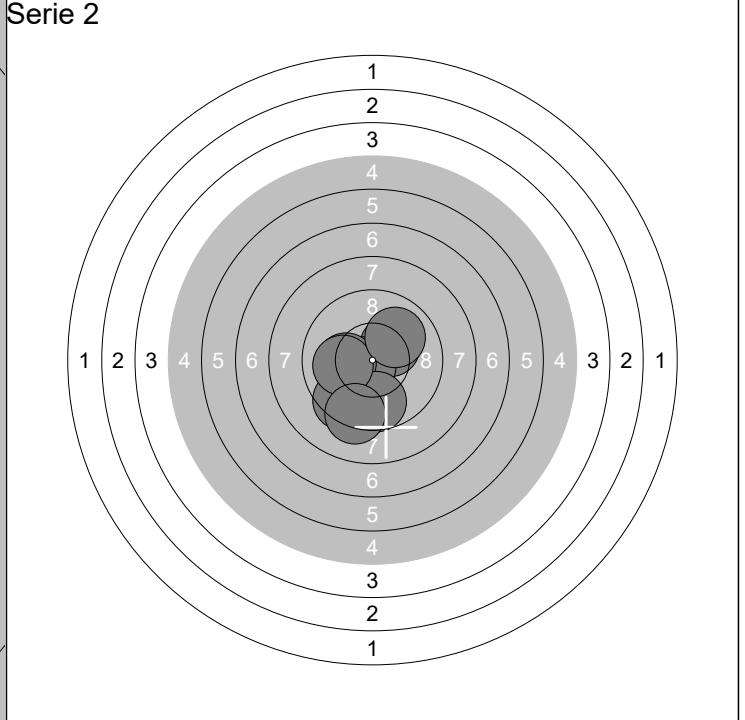
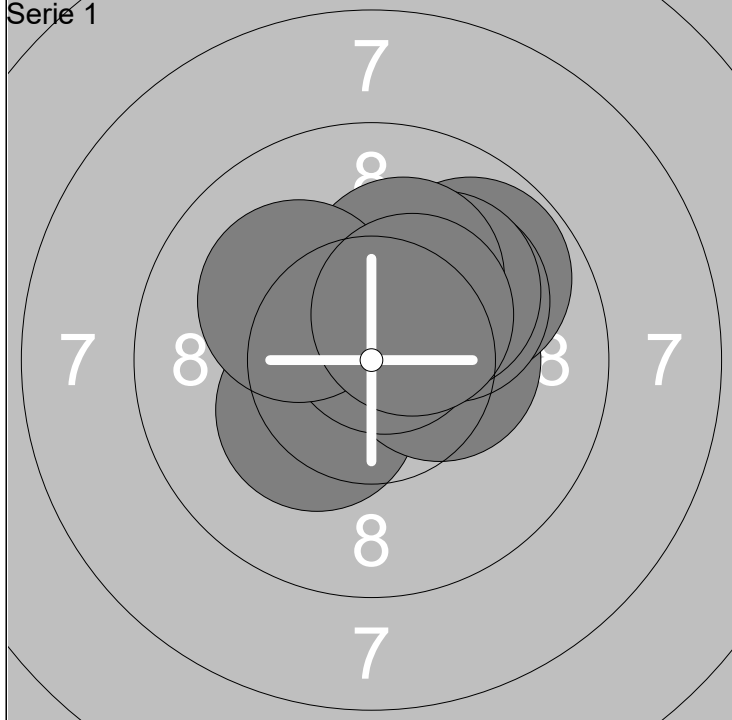

1: 10.2x ↗	6: 10.1 ↗	Serie	102.2
2: 10.3x ↙	7: 10.1 ↗		
3: 10.3x →	8: 10.2x ↗	Total	102.2
4: 10.7x ↗	9: 10.1 ↙		
5: 9.8 ↗	10: 10.4x ↗		

11: 10.3x ↗	16: 9.7 ↓	Serie	90.0
12: 9.4 ↙	17: 0.0 ↓		
13: 10.4x ↙	18: 10.1 ←	Total	192.2
14: 10.7x ↙	19: 9.3 ↓		
15: 10.1 ←	20: 10.0 ↗		

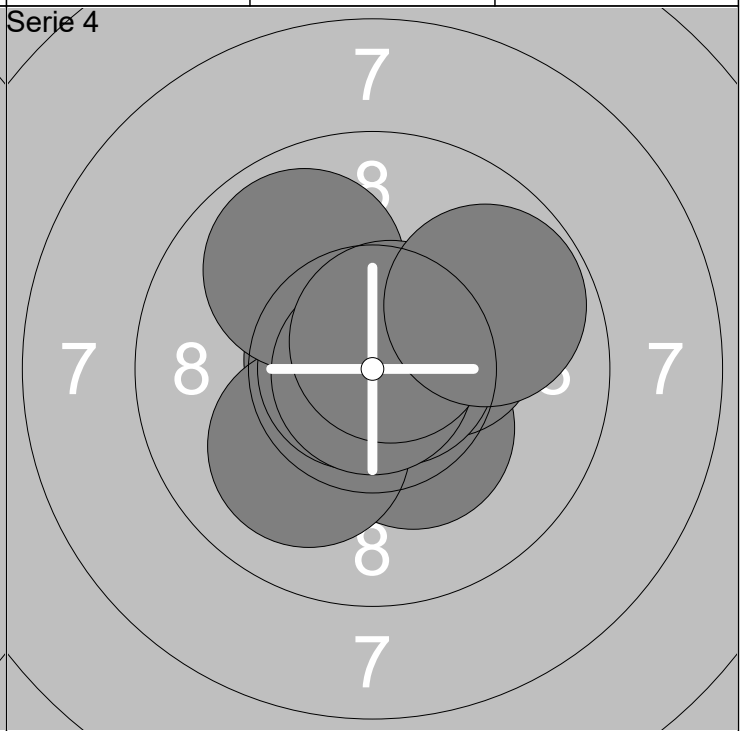
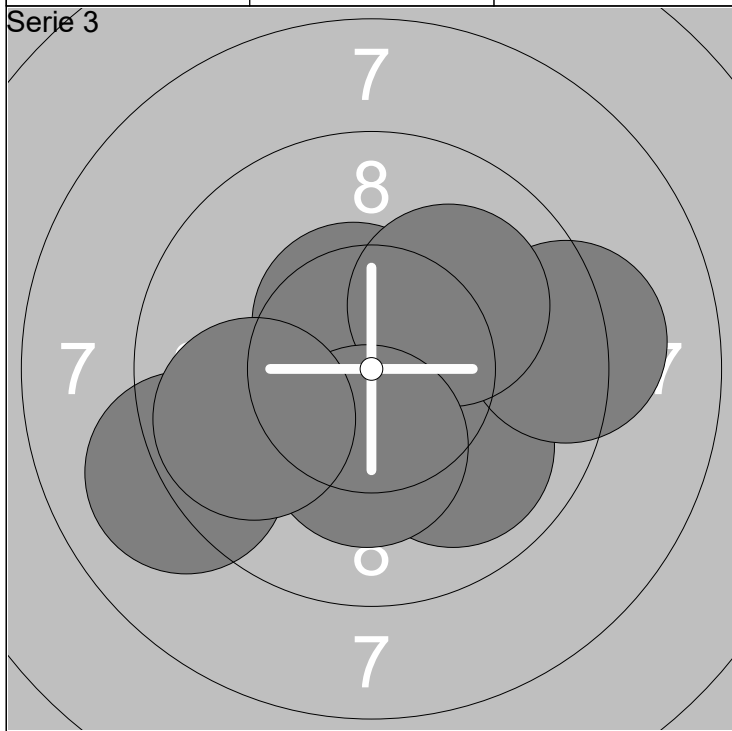

21: 9.1 ←	26: 9.9 ↘	Serie	99.8
22: 10.4x ↗	27: 9.2 →		
23: 10.2x ↗	28: 10.1 ↗	Total	292.0
24: 10.3x →	29: 10.3x ↓		
25: 10.5x ↗	30: 9.8 ←		

31: 10.3x ↘	36: 10.7x →	Serie	104.2
32: 10.3x →	37: 9.9 ↗		
33: 10.7x ←	38: 10.9x ↓	Total	396.2
34: 10.1 ↙	39: 10.7x ↗		
35: 10.8x ←	40: 9.8 ↗		

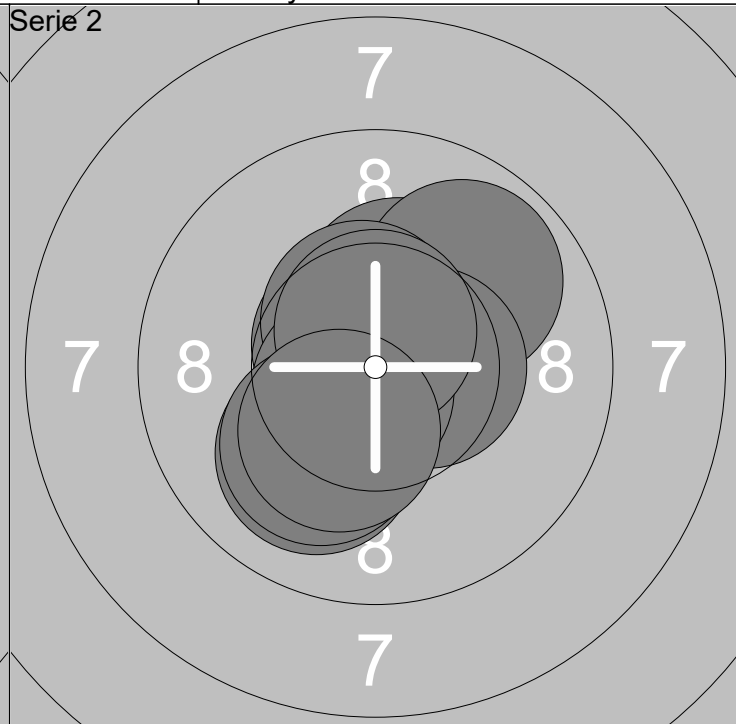
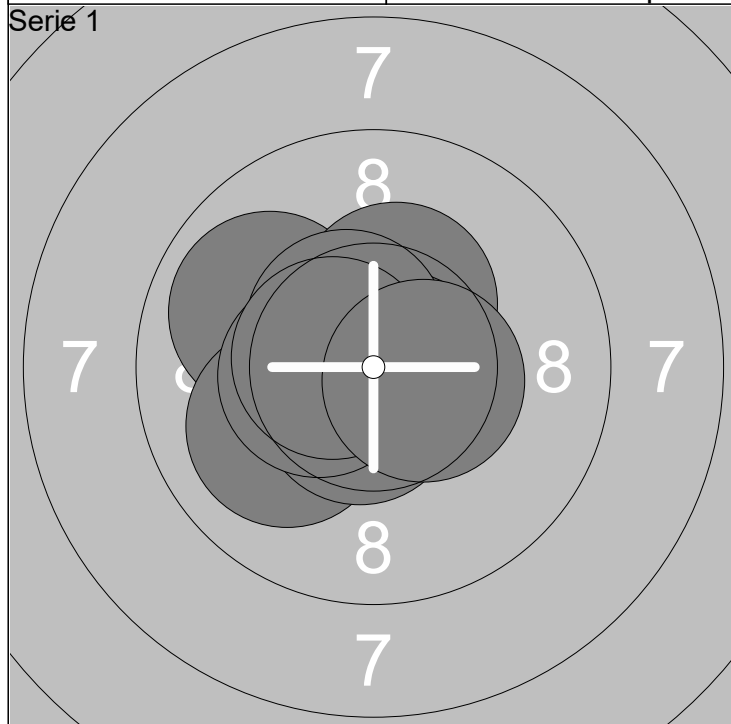

1: 9.9 ↖	6: 10.0 ↙	Serie	104.5
2: 10.8x ↙	7: 10.6x ↓		
3: 10.3x ↗	8: 10.5x ←	Total	104.5
4: 10.8x →	9: 10.6x ←		
5: 10.5x ↗	10: 10.5x →		

11: 10.6x ↖	16: 10.5x ↗	Serie	103.6
12: 10.3x ↗	17: 10.7x ↙		
13: 9.9 ↗	18: 10.1 ↙	Total	208.1
14: 10.1 ↙	19: 10.6x ↗		
15: 10.5x →	20: 10.3x ↙		

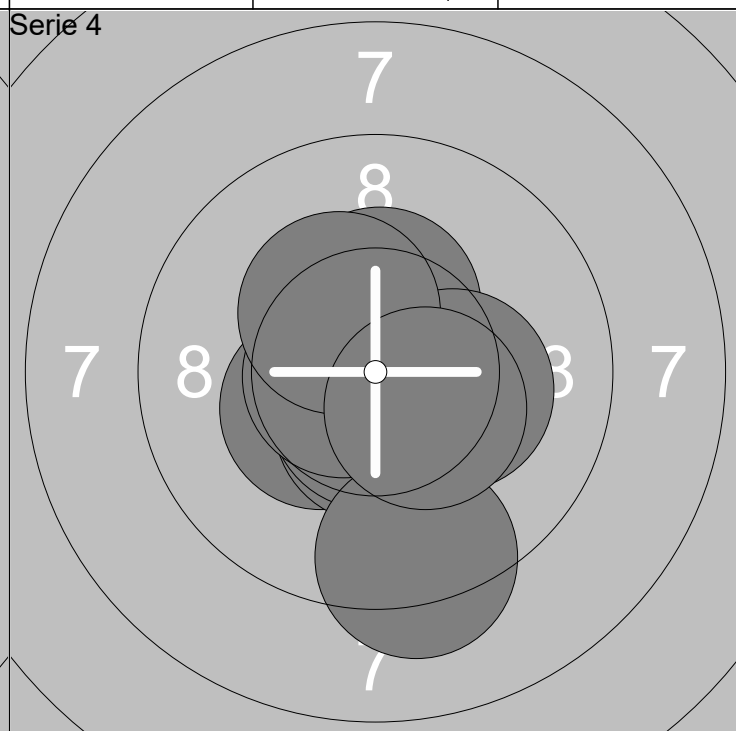
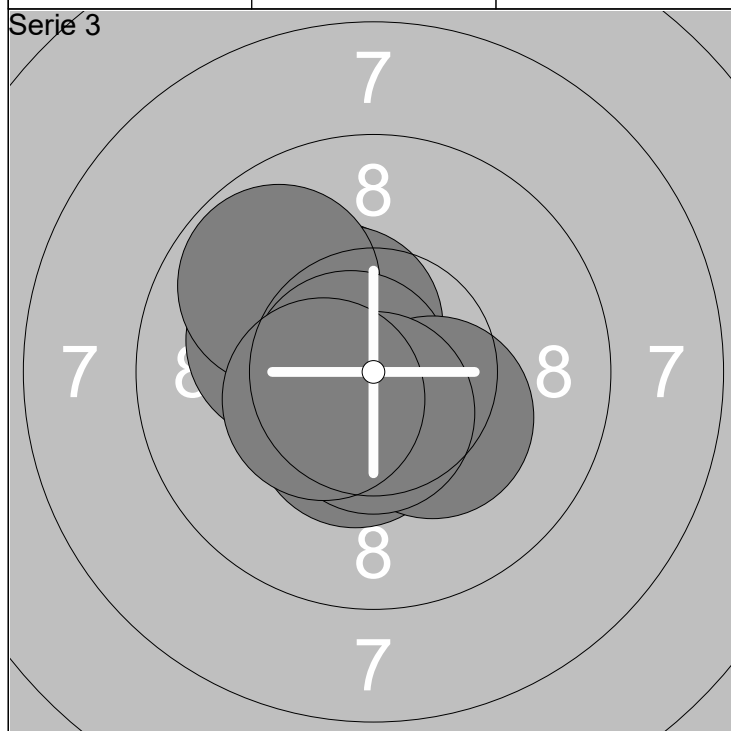

21: 10.6x ↙	26: 9.8 ↖	Serie	104.0
22: 10.5x ↓	27: 10.8x ←		
23: 10.1 ↖	28: 10.3x ↘	Total	312.1
24: 10.4x ↗	29: 10.6x ↓		
25: 10.5x ↗	30: 10.4x ↙		

31: 10.4x ↙	36: 10.6x ↓	Serie	103.5
32: 10.6x ↓	37: 9.3 ↓		
33: 10.4x ↗	38: 10.7x ←	Total	415.6
34: 10.5x ↓	39: 10.3x ↗		
35: 10.3x →	40: 10.4x ↘		



Rottne Industri Cup 2019

Tolg Skytteförening

Mini

26.10.2019

Rottne Industri Cup 2019

Söraby SKF

Serie 1

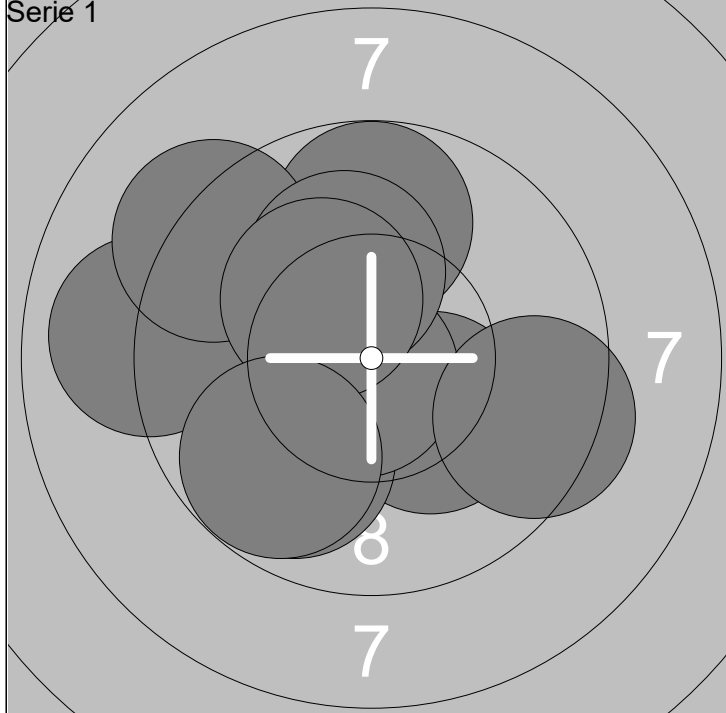

Serie 2

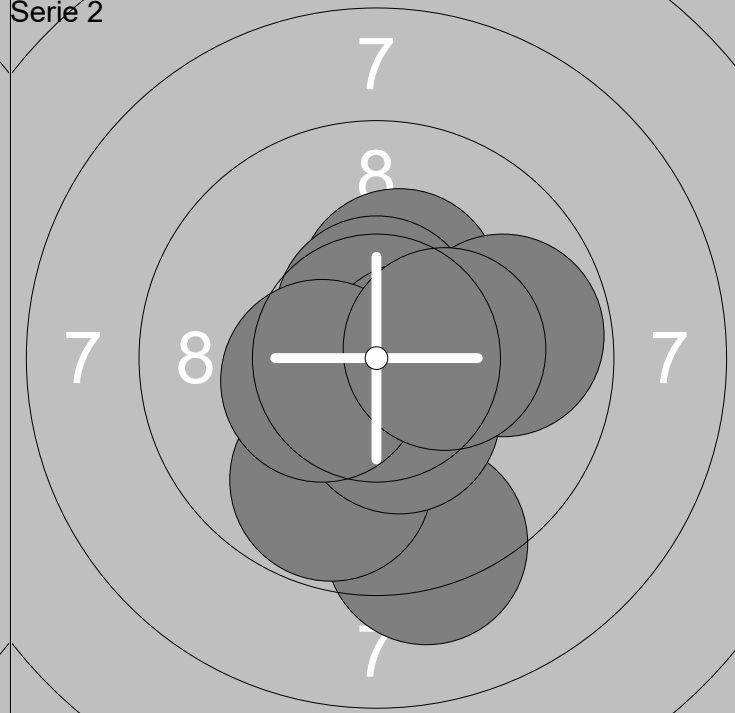

1: 9.7 ↑  
2: 10.3x ↓  
3: 9.0 ←  
4: 9.8 ↓  
5: 10.8x ↓

6: 9.4 →  
7: 9.2 ↗  
8: 10.1 ↑  
9: 10.3x ↗  
10: 9.8 ↓

Serie 98.4  
Total 98.4

11: 10.9x ↖  
12: 10.3x ↑  
13: 10.6x ↑  
14: 10.6x →  
15: 9.3 ↓

16: 9.8 ↓  
17: 10.4x ↓  
18: 9.8 →  
19: 10.4x ↖  
20: 10.3x →

Serie 102.4  
Total 200.8

Serie 3

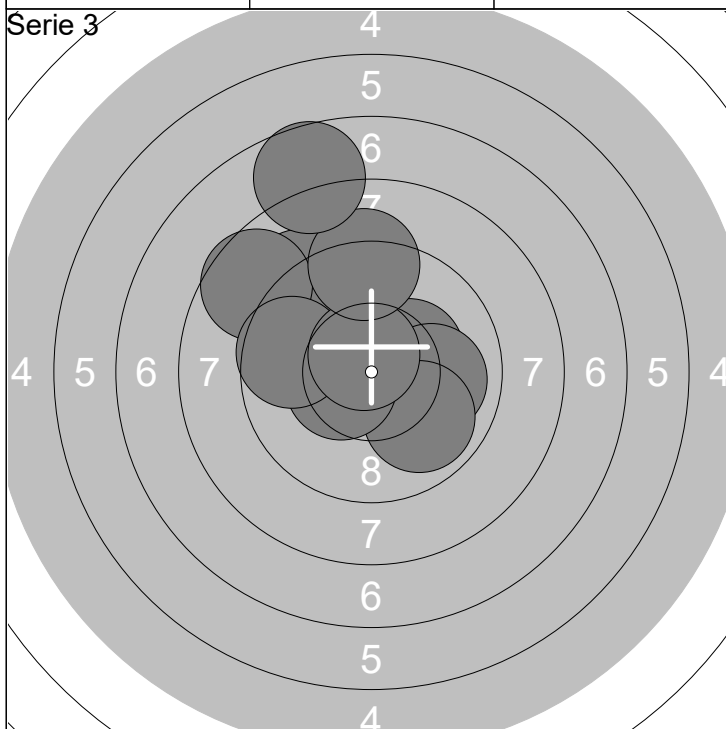

Serie 4

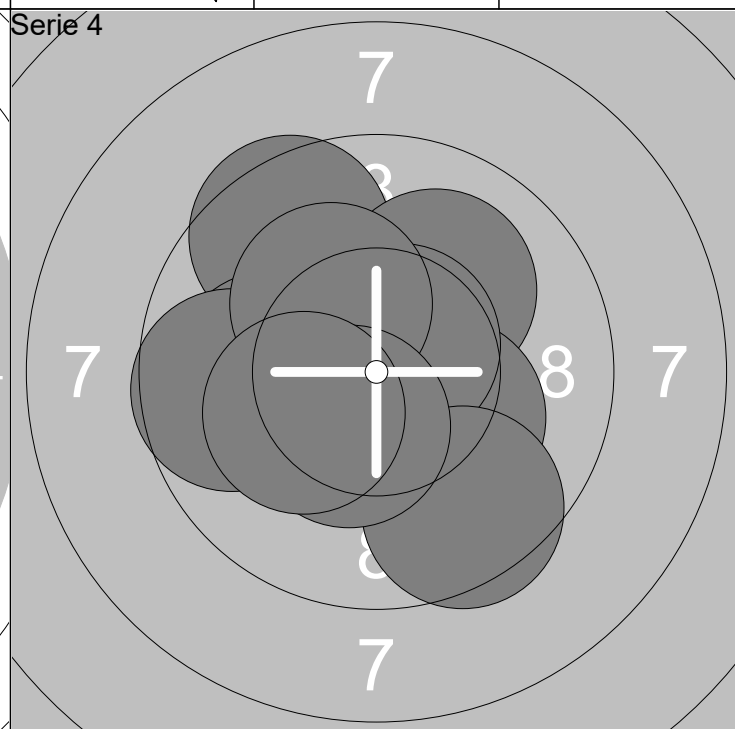

21: 10.3x →  
22: 10.0 →  
23: 9.9 ↓  
24: 9.1 ↗  
25: 8.6 ↗

26: 10.4x ↖  
27: 9.6 ↖  
28: 10.7x ↗  
29: 9.2 ↑  
30: 7.7 ↗

Serie 95.5  
Total 296.3

31: 9.5 ↖  
32: 10.1 ←  
33: 10.0 ↗  
34: 10.2x ↘  
35: 9.7 ←

36: 10.6x ↗  
37: 9.5 ↓  
38: 10.2x ↗  
39: 10.4x ↓  
40: 10.2x ↖

Serie 100.4  
Total 396.7

Rottne Industri Cup 2019

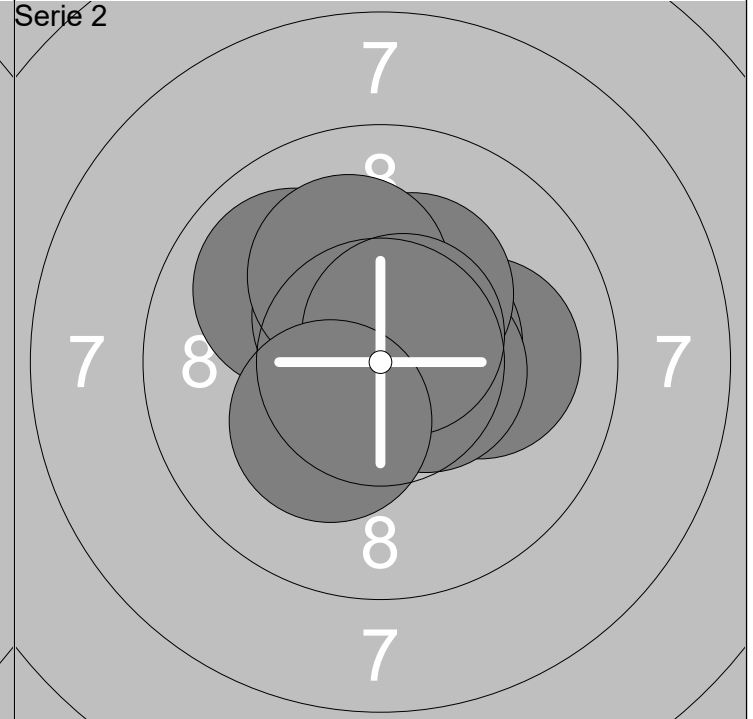
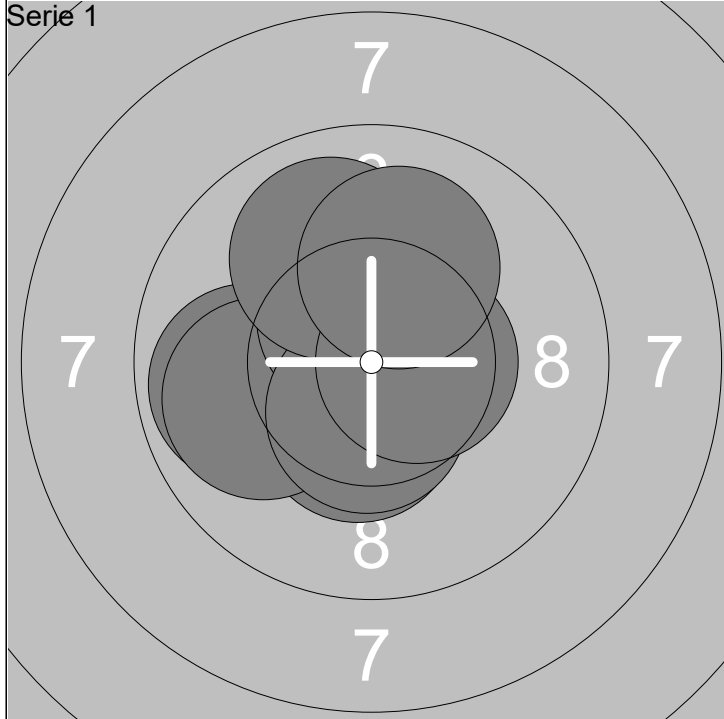

1: 10.6x ↓	6: 10.5x ↑	Serie	102.9
2: 10.4x ↓	7: 10.5x ↓		
3: 10.6x ←	8: 9.9 ↑	Total	102.9
4: 9.9 ←	9: 10.5x →		
5: 9.9 ←	10: 10.1 ↑		

11: 10.2x ↖	16: 10.5x ↖	Serie	103.1
12: 10.0 →	17: 10.3x ↗		
13: 10.5x ↗	18: 10.1 ↑	Total	206.0
14: 10.6x →	19: 10.6x ↗		
15: 10.0 ↖	20: 10.3x ↙		

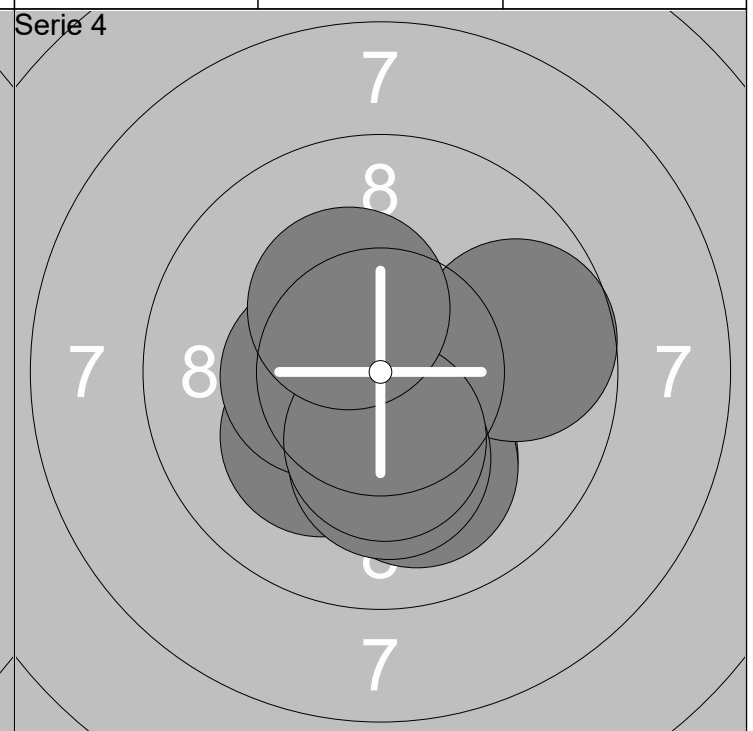
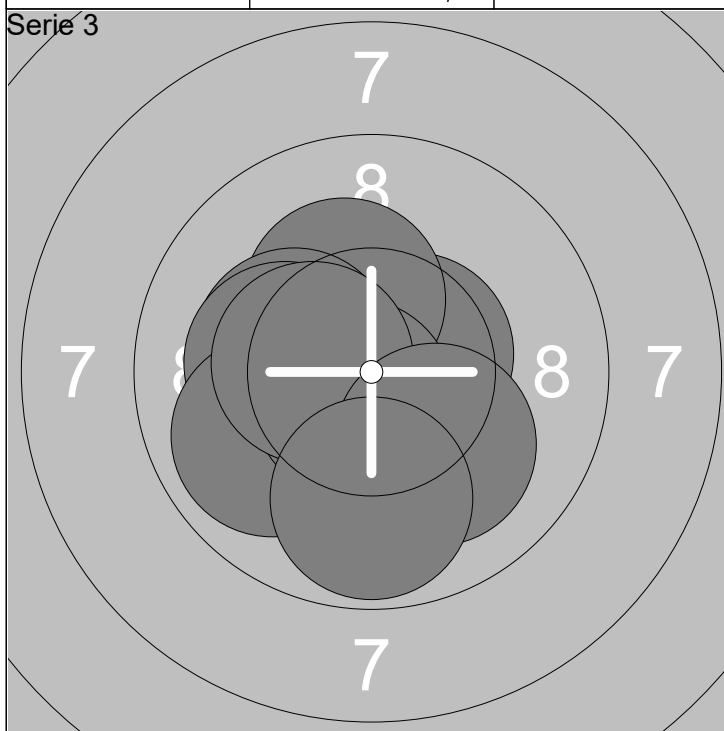

21: 10.5x ↗	26: 9.9 ←	Serie	102.3
22: 10.3x ↗	27: 10.7x ↓		
23: 10.2x ←	28: 10.4x ←	Total	308.3
24: 10.2x ↓	29: 10.1 ↓		
25: 10.2x ←	30: 9.8 ↓		

31: 10.1 ↓	36: 10.4x ←	Serie	103.1
32: 10.9x ↓	37: 9.7 →		
33: 10.2x ↙	38: 10.2x ↓	Total	411.4
34: 10.9x →	39: 10.4x ↓		
35: 10.0 ↓	40: 10.3x ↗		

Serie 1

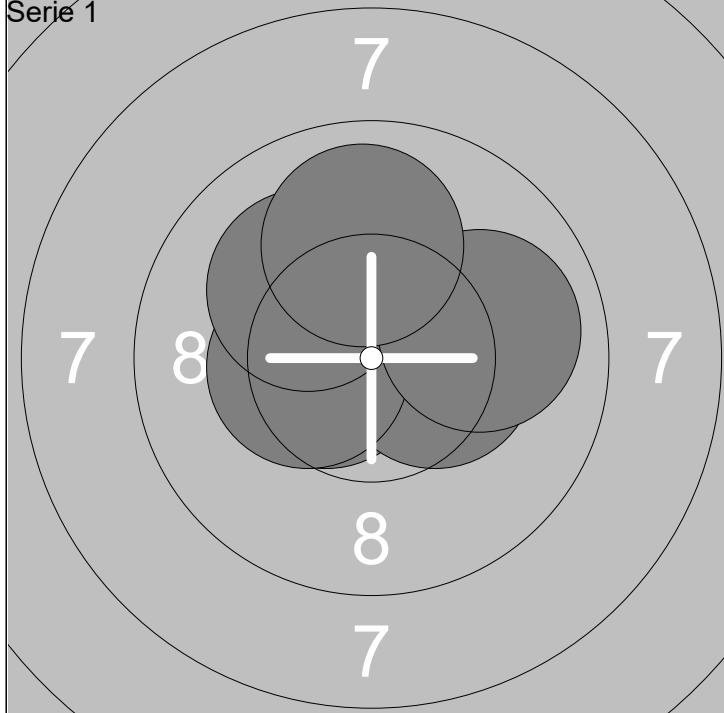

Serie 2

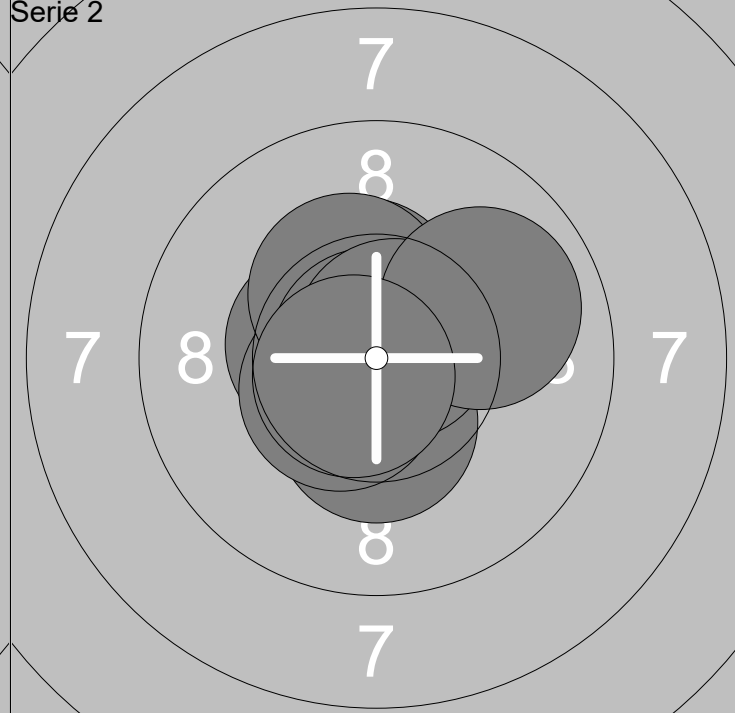

1: 10.6x ↖	6: 10.4x →
2: 10.5x ↑	7: 10.4x ←
3: 10.4x →	8: 10.1 ↖
4: 10.5x ←	9: 10.0 →
5: 10.5x ↗	10: 10.0 ↑

Serie	103.4
Total	103.4

11: 10.4x ↑	16: 10.3x ↖
12: 10.4x ↓	17: 10.8x ↖
13: 10.5x ←	18: 10.7x ↗
14: 10.8x ↑	19: 9.9 ↗
15: 10.5x ↙	20: 10.7x ↙

Serie	105.0
Total	208.4

Serie 3

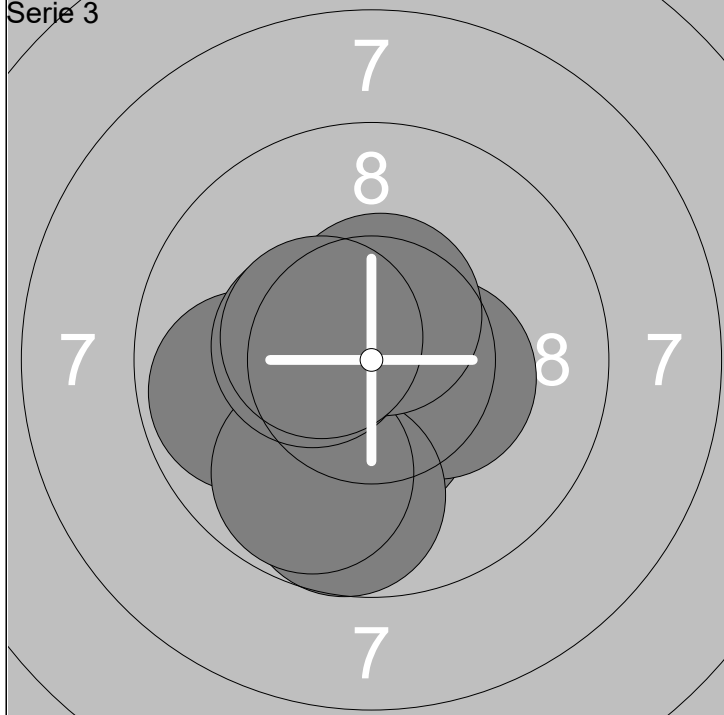

Serie 4

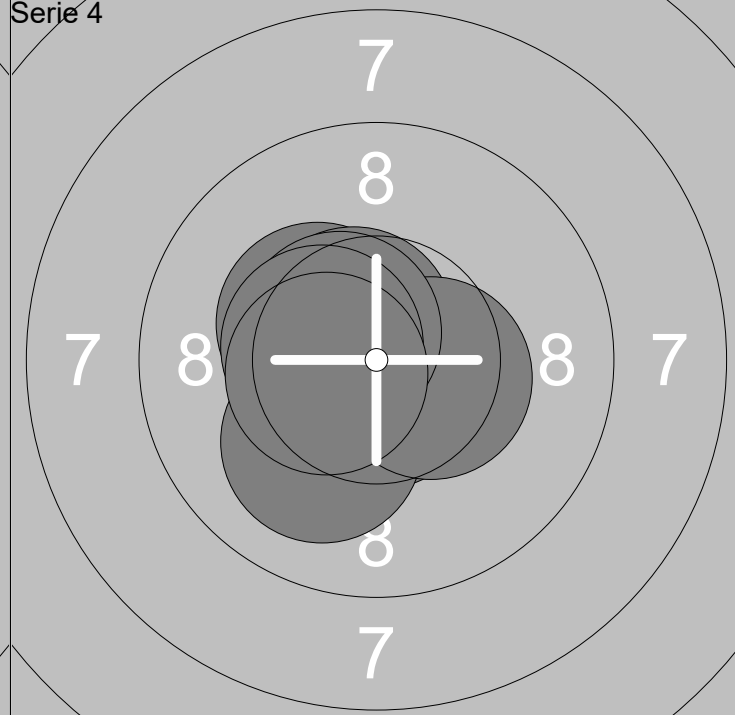

21: 10.8x →	26: 9.7 ↓
22: 10.4x ↓	27: 9.8 ↓
23: 10.6x ↓	28: 10.5x ↑
24: 9.8 ←	29: 10.4x ←
25: 10.4x →	30: 10.5x ↙

Serie	102.9
Total	311.3

31: 10.3x ↖	36: 10.1 ↙
32: 10.6x ↖	37: 10.4x →
33: 10.6x ↖	38: 10.6x ↖
34: 10.7x ↓	39: 10.5x ←
35: 10.8x ↓	40: 10.5x ←

Serie	105.1
Total	416.4

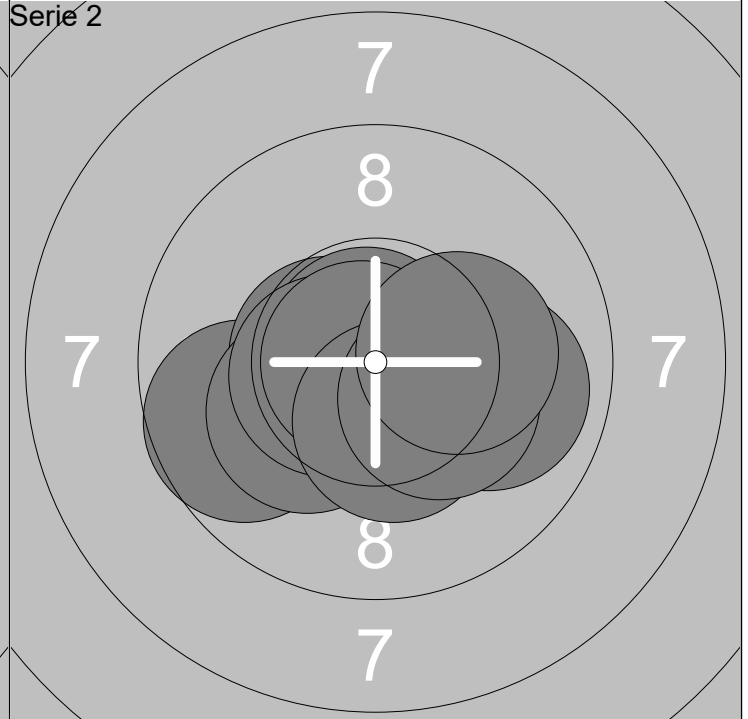
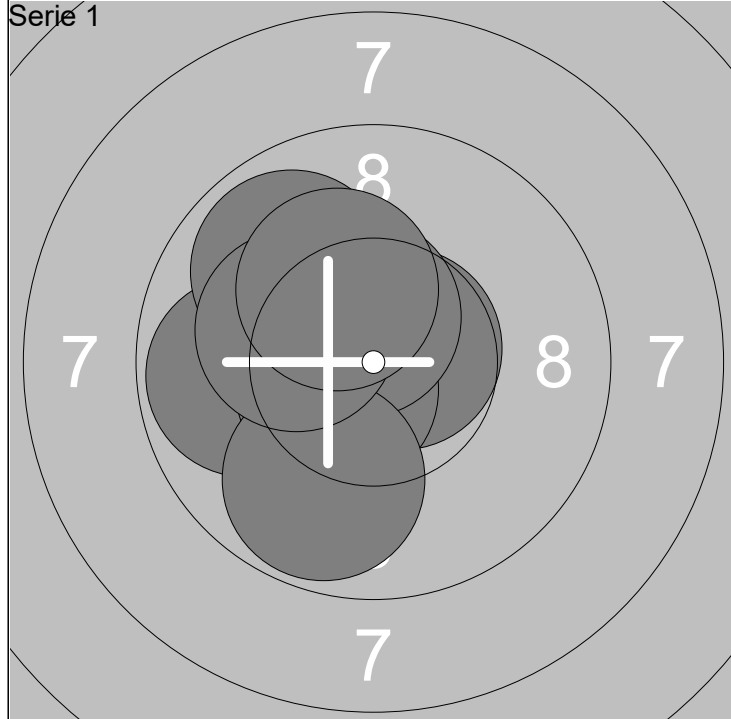

1: 10.1 ←	6: 9.9 ↗	Serie	102.4
2: 9.8 ←	7: 10.5x ↗		
3: 10.6x ←	8: 9.8 ↓	Total	102.4
4: 10.7x ↗	9: 10.2x ←		
5: 10.6x ↙	10: 10.2x ↗		

11: 9.7 ←	16: 10.5x ←	Serie	103.3
12: 10.5x ←	17: 10.8x ←		
13: 10.2x ↙	18: 10.4x ↓	Total	205.7
14: 10.8x ↗	19: 10.3x ↘		
15: 9.9 →	20: 10.2x →		

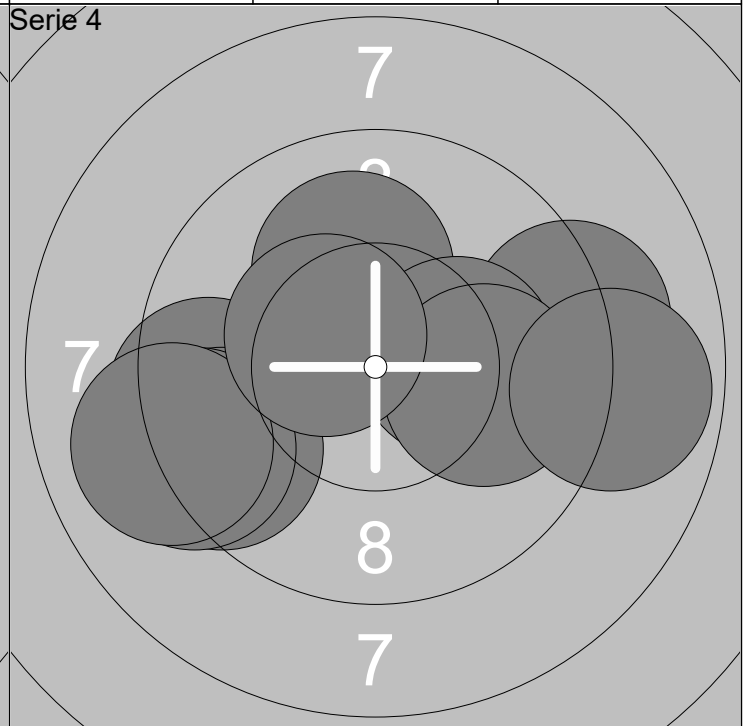
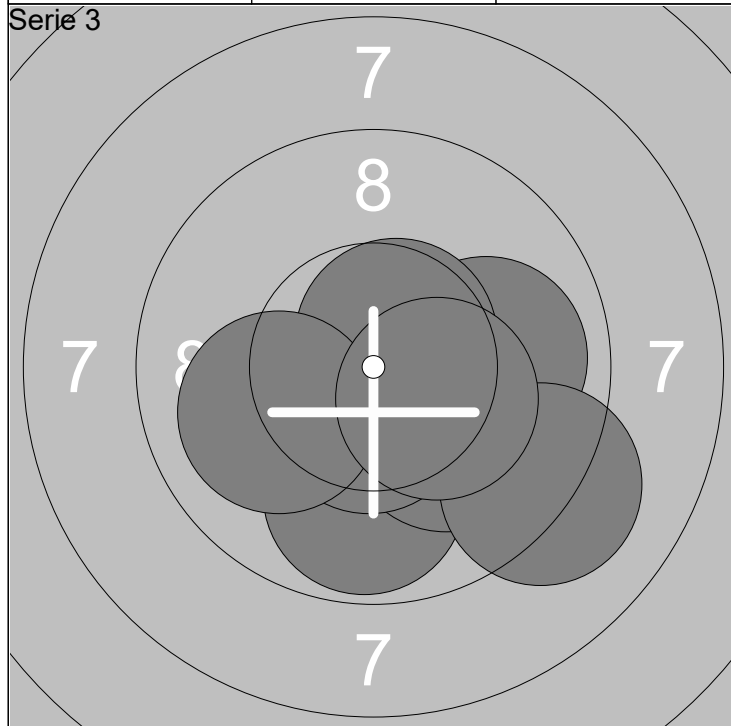

21: 10.3x ↓	26: 9.1 ↘	Serie	101.3
22: 10.6x ↘	27: 10.5x ↓		
23: 10.0 →	28: 10.6x ↗	Total	307.0
24: 9.8 ↓	29: 10.0 ←		
25: 10.1 ↘	30: 10.3x ↘		

31: 9.4 ←	36: 9.2 ←	Serie	95.7
32: 10.1 ↗	37: 9.0 ←		
33: 9.2 →	38: 10.0 →	Total	402.7
34: 10.2x →	39: 8.8 →		
35: 9.4 ←	40: 10.4x ↗		

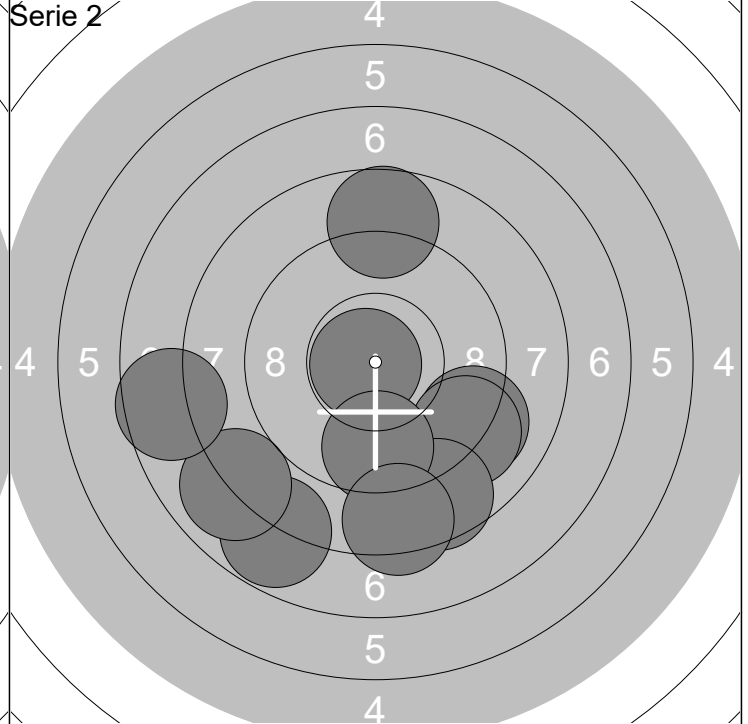
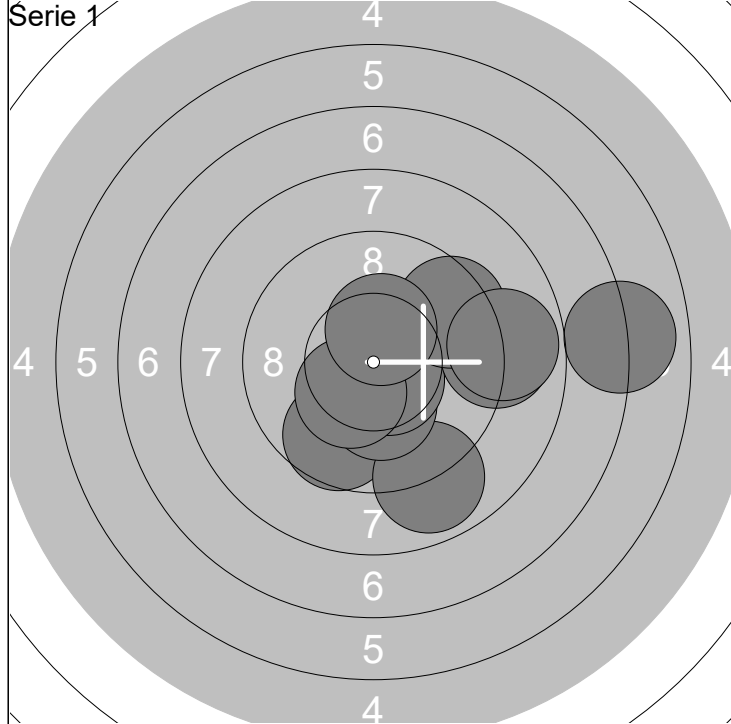

1: 9.7 ↘	6: 10.4x ↘	Serie	94.6
2: 8.9 ↘	7: 9.0 →		
3: 10.3x ↘	8: 9.5 ↗	Total	94.6
4: 7.0 →	9: 10.4x ↑		
5: 10.6x ↘	10: 8.8 →		

11: 9.1 ↘	16: 8.0 ↙	Serie	87.7
12: 9.1 ↘	17: 7.6 ←		
13: 7.8 ↘	18: 8.6 ↘	Total	182.3
14: 8.7 ↑	19: 9.6 ↘		
15: 10.8x ←	20: 8.4 ↘		

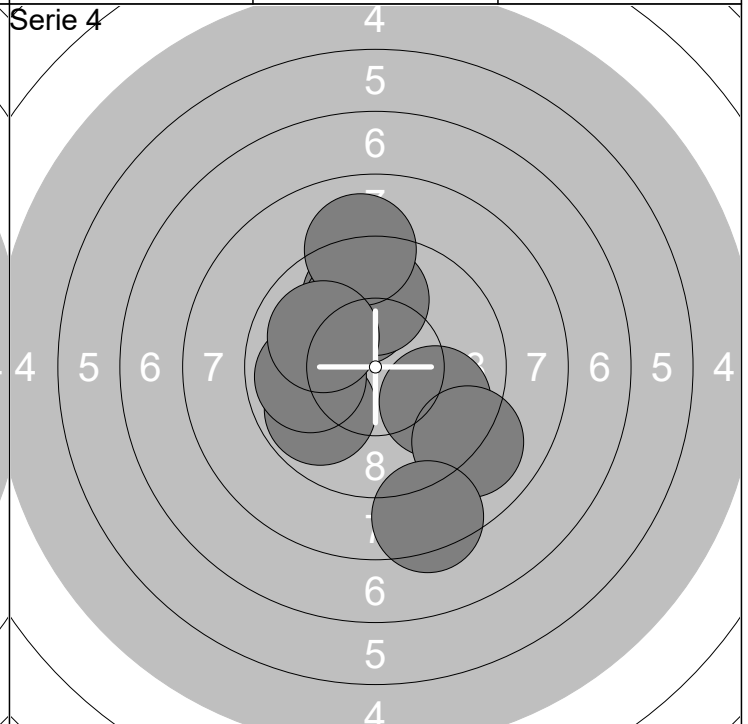
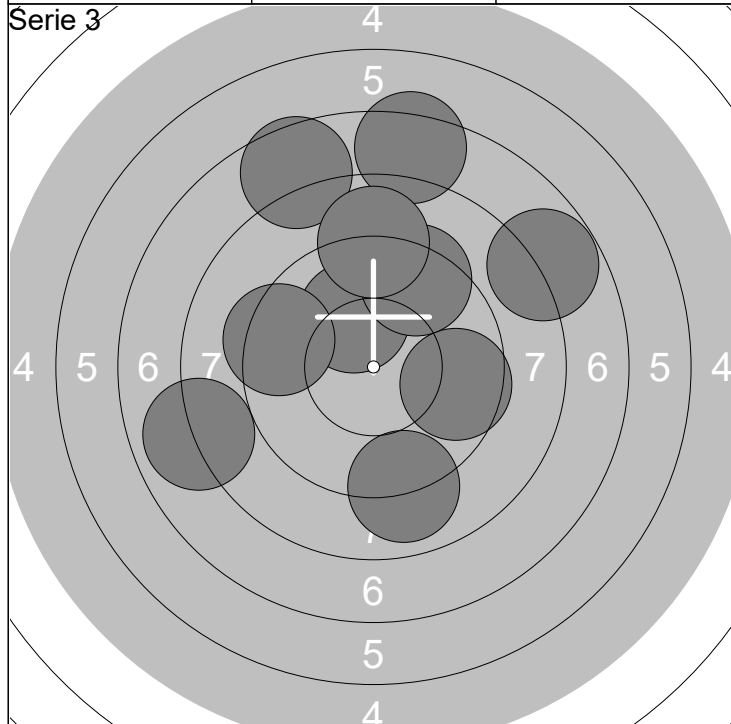

21: 7.4 ↑	26: 10.1 ↗	Serie	87.3
22: 8.0 ←	27: 9.4 ←		
23: 9.6 →	28: 9.4 ↗	Total	269.6
24: 7.6 ↑	29: 9.0 ↑		
25: 7.8 ↗	30: 9.0 ↘		

31: 9.8 ↑	36: 9.9 ←	Serie	95.6
32: 10.0 ↑	37: 9.0 ↑		
33: 9.8 ↘	38: 9.0 ↘	Total	365.2
34: 9.8 ←	39: 8.4 ↘		
35: 9.9 ↑	40: 10.0 ↗		

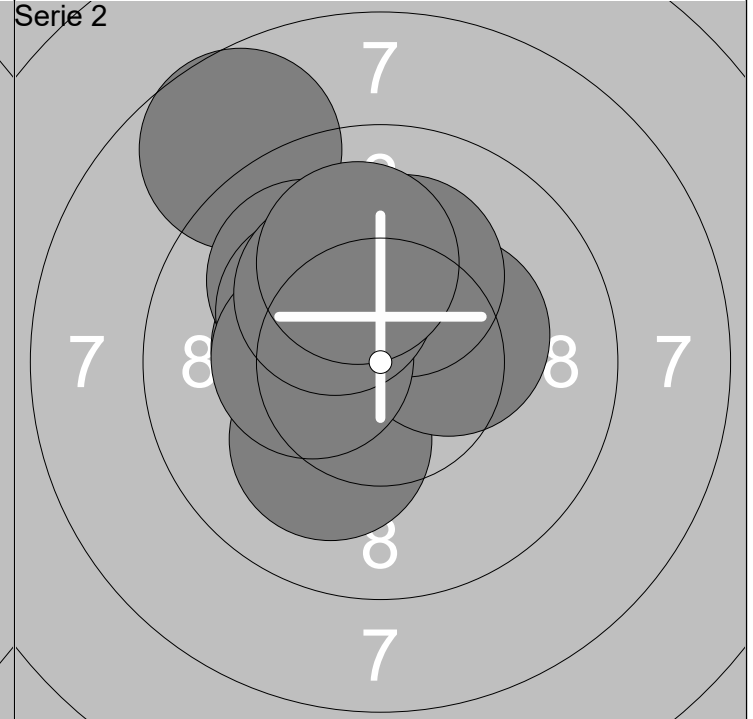
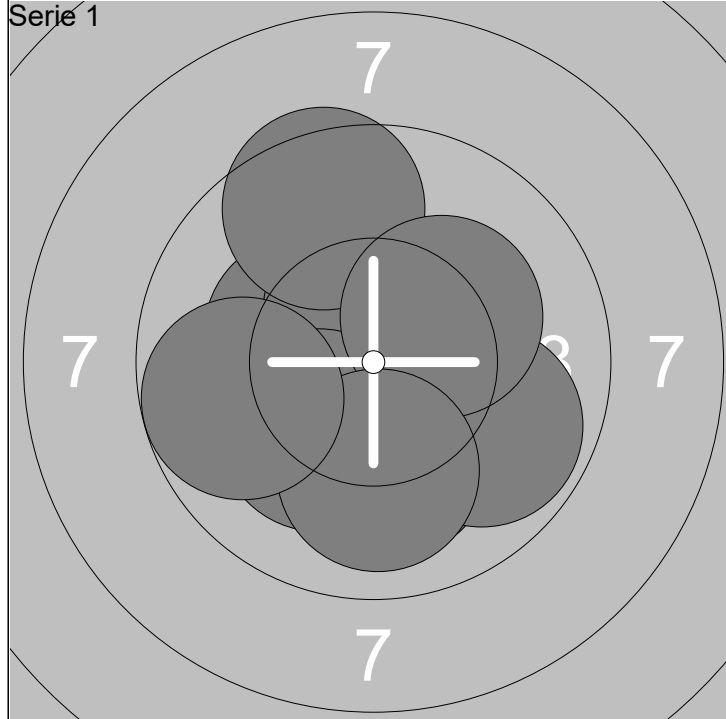

1: 10.1 ↓	6: 9.8 ↘	Serie	100.7
2: 10.3x ↙	7: 10.2x ↘		
3: 10.4x ↘	8: 10.2x ↗	Total	100.7
4: 10.5x ↑	9: 10.0 ↓		
5: 9.5 ↑	10: 9.7 ←		

11: 10.1 ↙	16: 10.2x ↑	Serie	100.4
12: 8.7 ↗	17: 10.2x ↙		
13: 10.3x ←	18: 10.4x ←	Total	201.1
14: 10.0 ↗	19: 10.2x ↗		
15: 10.3x ↗	20: 10.0 ↑		

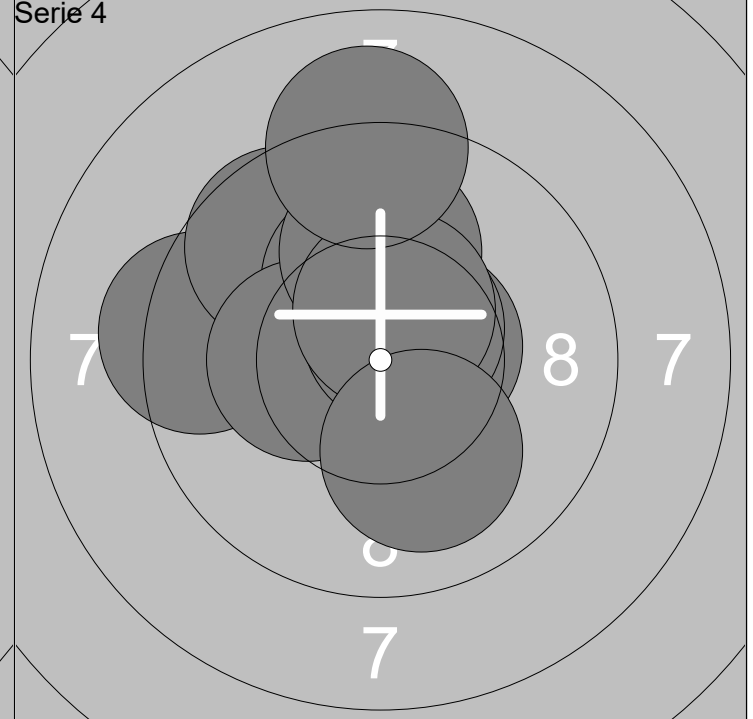
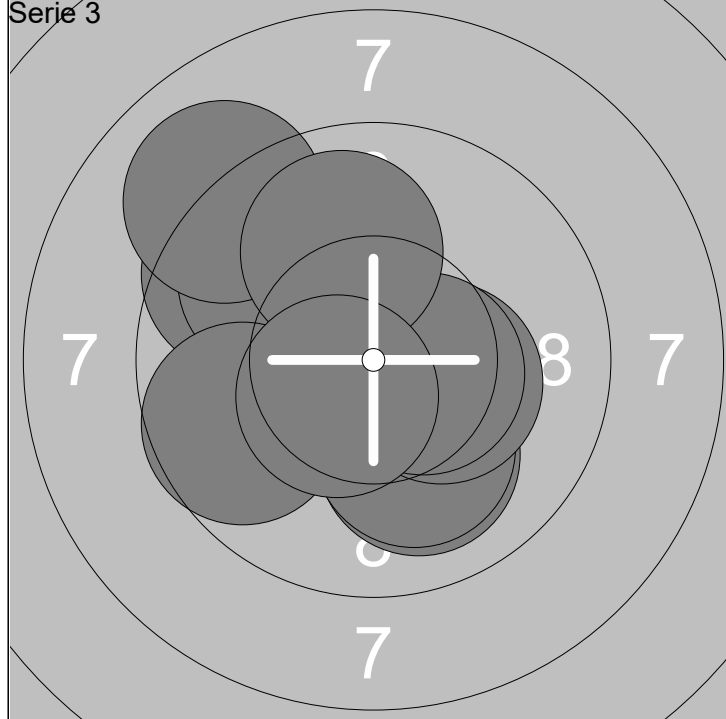

21: 10.0 ↘	26: 10.3x ↘	Serie	99.5
22: 9.6 ↗	27: 9.7 ←		
23: 10.1 ↘	28: 10.5x ↘	Total	300.6
24: 9.8 ↗	29: 10.0 ↑		
25: 9.0 ↗	30: 10.5x ↘		

31: 10.6x ↗	36: 10.6x ↗	Serie	100.3
32: 9.3 ←	37: 10.0 ↑		
33: 9.6 ↗	38: 10.5x ↑	Total	400.9
34: 10.2x ↑	39: 9.1 ↑		
35: 10.3x ←	40: 10.1 ↓		

Serie 1

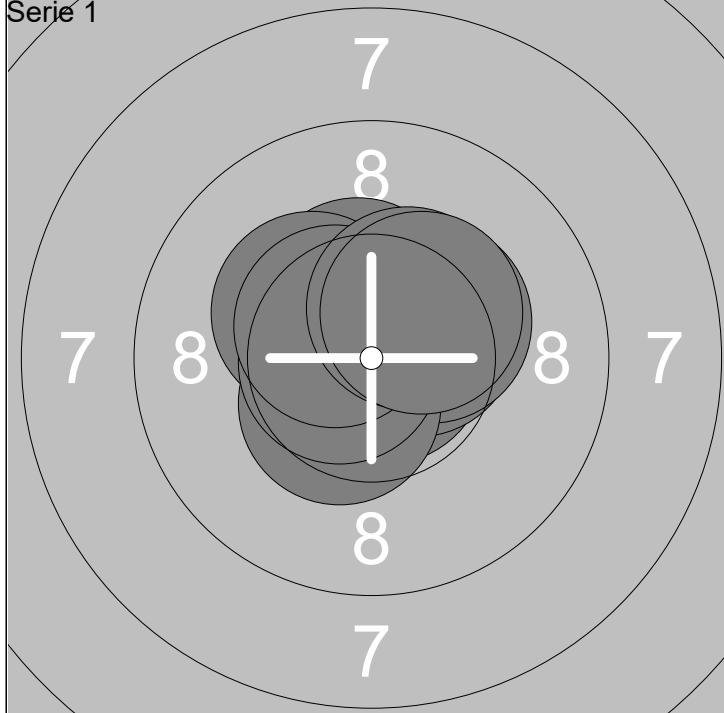

1: 10.4x ↗  
2: 10.8x →  
3: 10.5x ↘  
4: 10.3x ↘  
5: 10.4x ↙

6: 10.3x ↖  
7: 10.7x ←  
8: 10.5x ↖  
9: 10.4x ↗  
10: 10.3x ↗

Serie 104.6  
Total 104.6

Serie 2

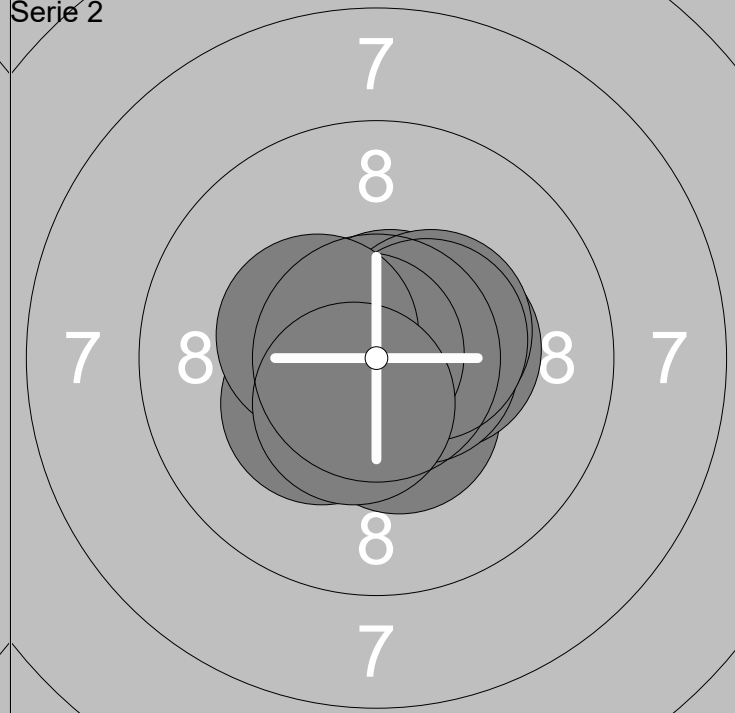

11: 10.4x ↘  
12: 10.4x →  
13: 10.7x ↗  
14: 10.4x ↘  
15: 10.6x →

16: 10.5x →  
17: 10.3x ↘  
18: 10.8x ←  
19: 10.4x ←  
20: 10.5x ↙

Serie 105.0  
Total 209.6

Serie 3

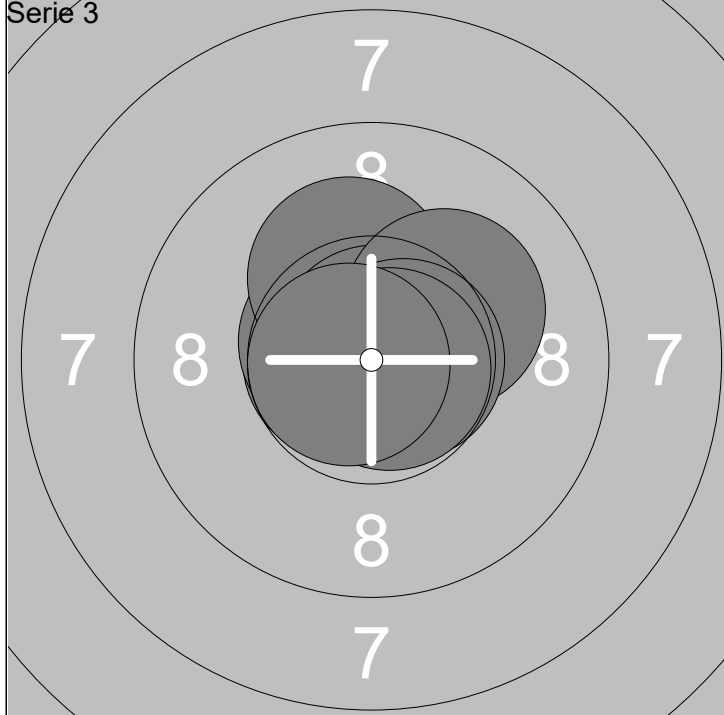

21: 10.7x ←  
22: 10.9x →  
23: 10.6x ↗  
24: 10.6x ↖  
25: 10.2x ↗

26: 10.8x ↗  
27: 10.2x ↗  
28: 10.7x →  
29: 10.8x ↘  
30: 10.7x ←

Serie 106.2  
Total 315.8

Serie 4

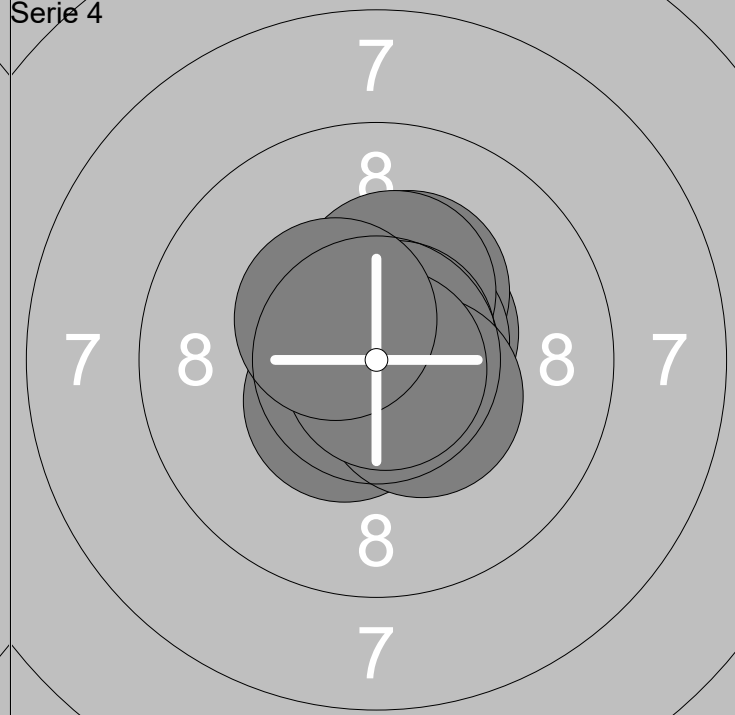

31: 10.5x ↘  
32: 10.3x ↗  
33: 10.6x ↘  
34: 10.7x ↗  
35: 10.3x ↗

36: 10.7x ↗  
37: 10.5x ↙  
38: 10.5x ↘  
39: 10.8x ↘  
40: 10.4x ↗

Serie 105.3  
Total 421.1

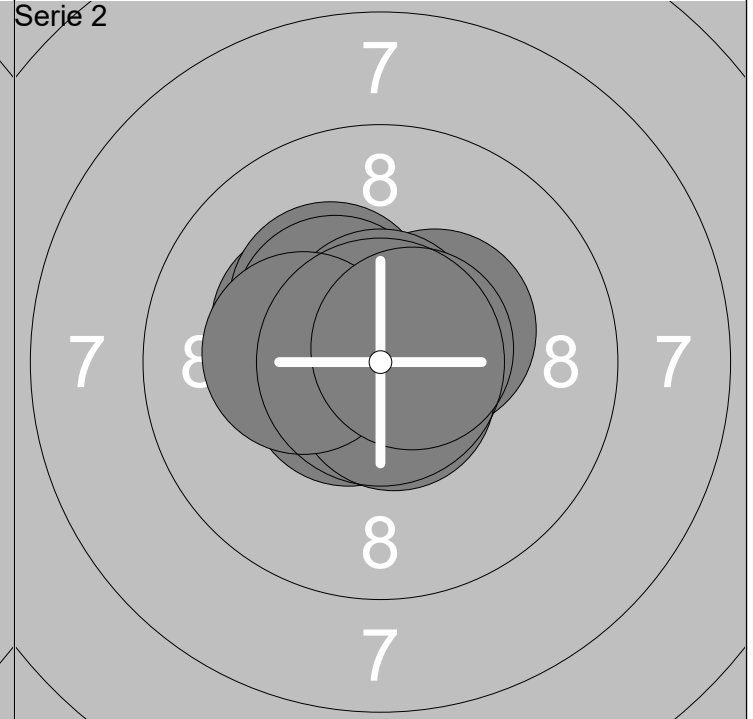
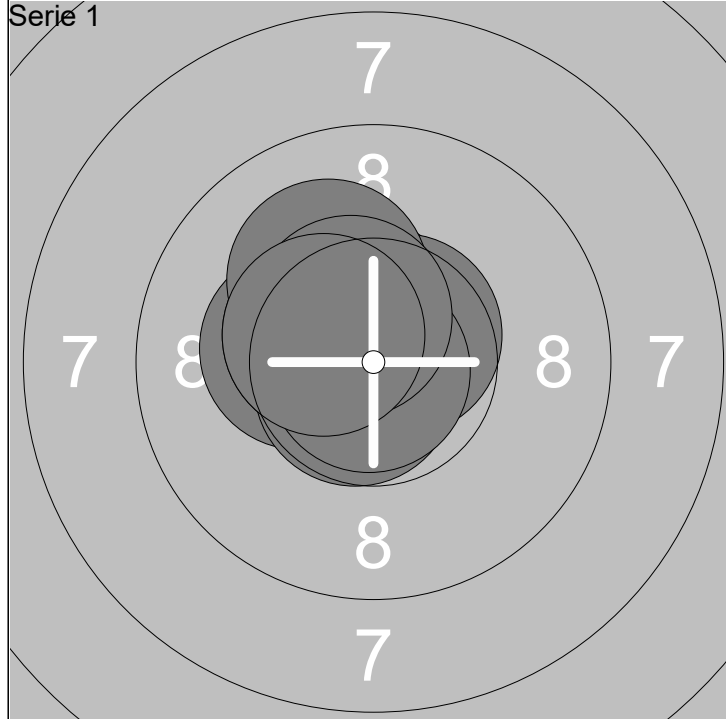

1: 10.3x ←	6: 10.7x ↙	Serie 105.1
2: 10.7x ←	7: 10.9x ↘	
3: 10.5x ↗	8: 10.1 ↖	Total 105.1
4: 10.6x ↗	9: 10.5x ↖	
5: 10.4x ↖	10: 10.4x ↖	

11: 10.3x ←	16: 10.4x ↗	Serie 105.0
12: 10.3x ↗	17: 10.7x ↘	
13: 10.6x ↗	18: 10.7x ↗	Total 210.1
14: 10.6x ↖	19: 10.3x ←	
15: 10.4x ↖	20: 10.7x ↗	

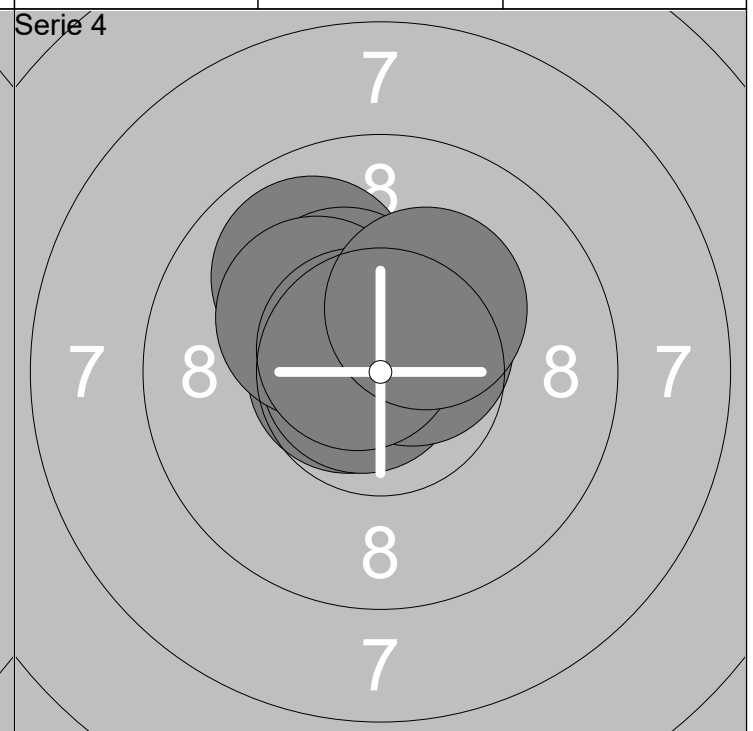
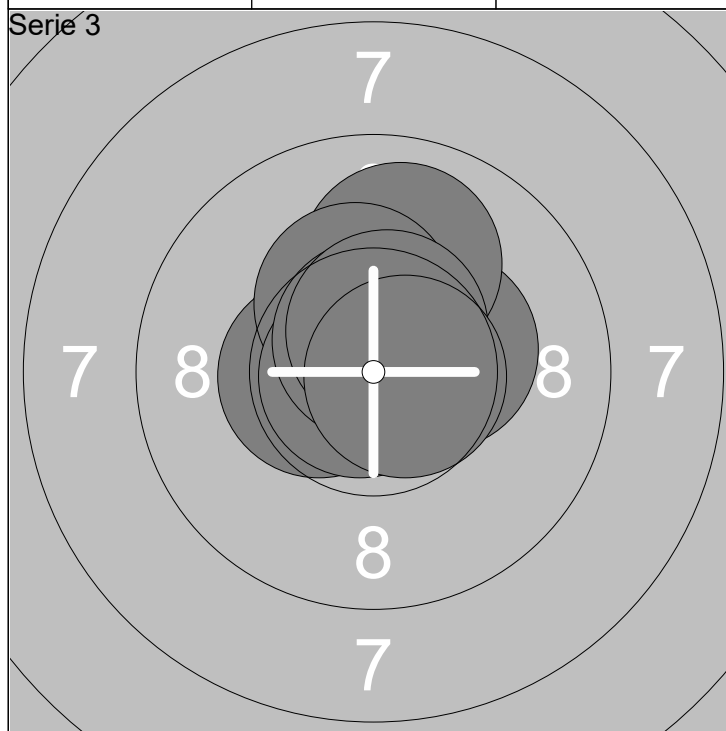

21: 10.4x ↗	26: 10.3x ↗	Serie 105.2
22: 10.7x ↗	27: 10.8x ←	
23: 10.6x ↖	28: 10.7x ↗	Total 315.3
24: 10.5x ←	29: 10.6x ↗	
25: 9.9 ↗	30: 10.7x →	

31: 9.9 ↖	36: 10.3x ↖	Serie 104.6
32: 10.5x ↗	37: 10.2x ↖	
33: 10.7x ←	38: 10.6x ↗	Total 419.9
34: 10.6x ↗	39: 10.7x ↖	
35: 10.8x ←	40: 10.3x ↗	



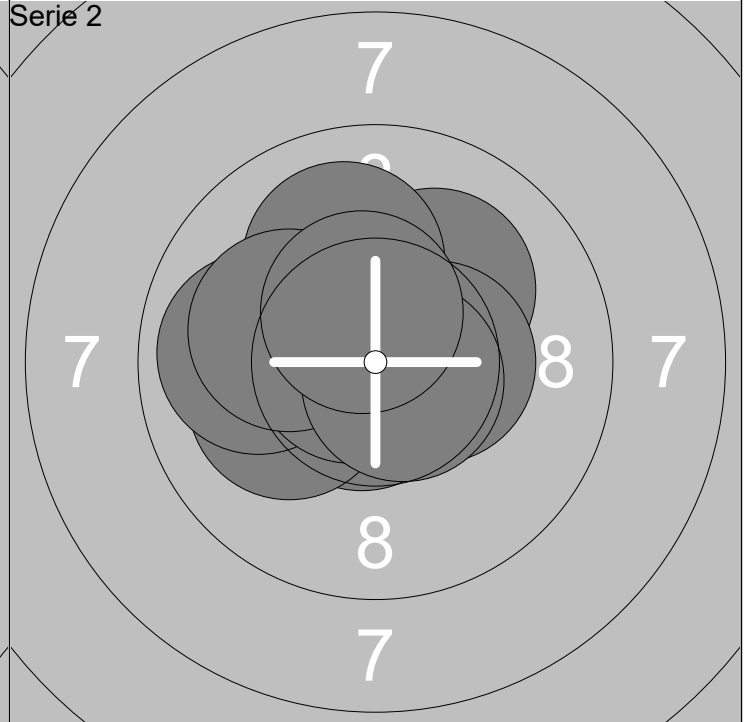
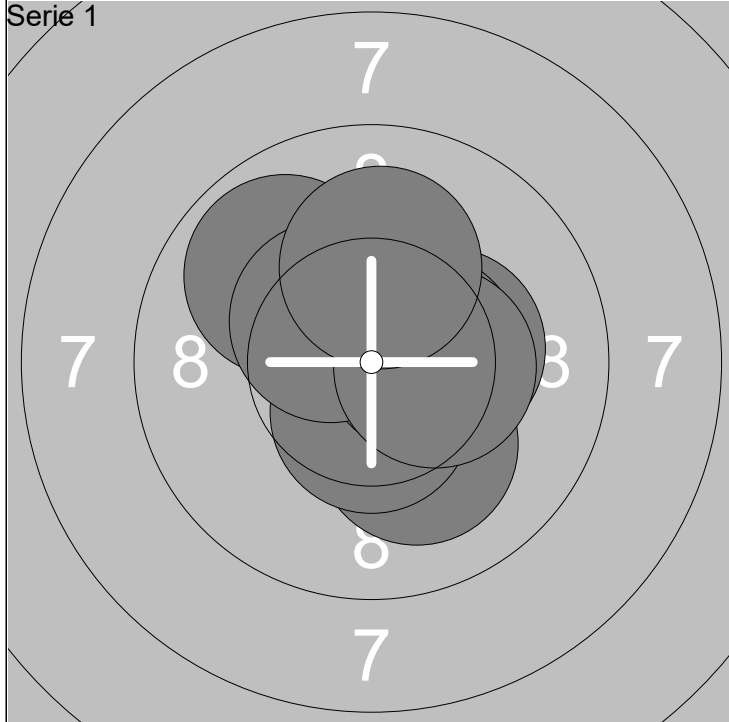

1: 10.1 ↘	6: 10.5x ↓	Serie	103.5
2: 10.6x →	7: 10.5x →		
3: 10.3x →	8: 10.4x ↗	Total	103.5
4: 10.7x ↗	9: 10.4x →		
5: 9.9 ↖	10: 10.1 ↑		

11: 10.7x ↘	16: 10.7x ←	Serie	103.2
12: 10.1 ←	17: 10.1 ←		
13: 9.9 ←	18: 10.4x →	Total	206.7
14: 10.1 ↗	19: 10.7x ↘		
15: 10.0 ↗	20: 10.5x ↑		

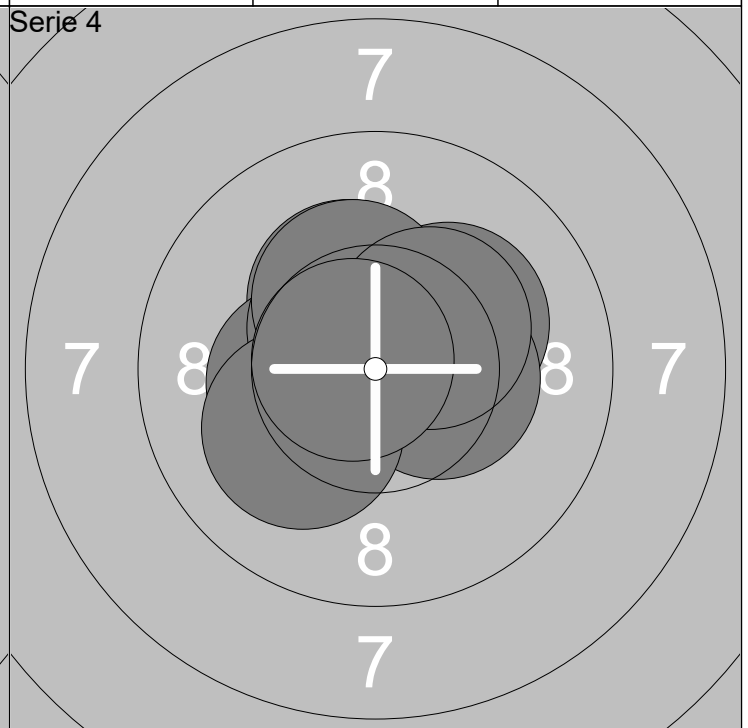
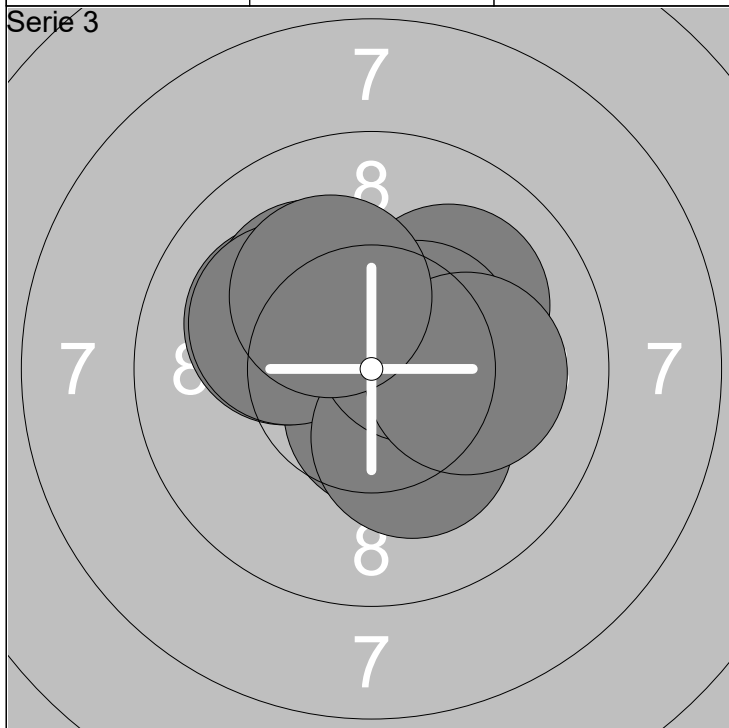

21: 10.7x ↗	26: 10.3x ↓	Serie	102.9
22: 10.6x ↓	27: 10.1 ↗		
23: 10.1 ←	28: 10.5x ↗	Total	309.6
24: 10.2x ↗	29: 10.1 →		
25: 10.1 ↖	30: 10.2x ↗		

31: 10.2x ↗	36: 10.5x ↗	Serie	103.8
32: 10.7x ↗	37: 10.3x ↑		
33: 10.4x →	38: 10.3x ↗	Total	413.4
34: 10.3x ↑	39: 10.1 ←		
35: 10.3x ←	40: 10.7x ←		

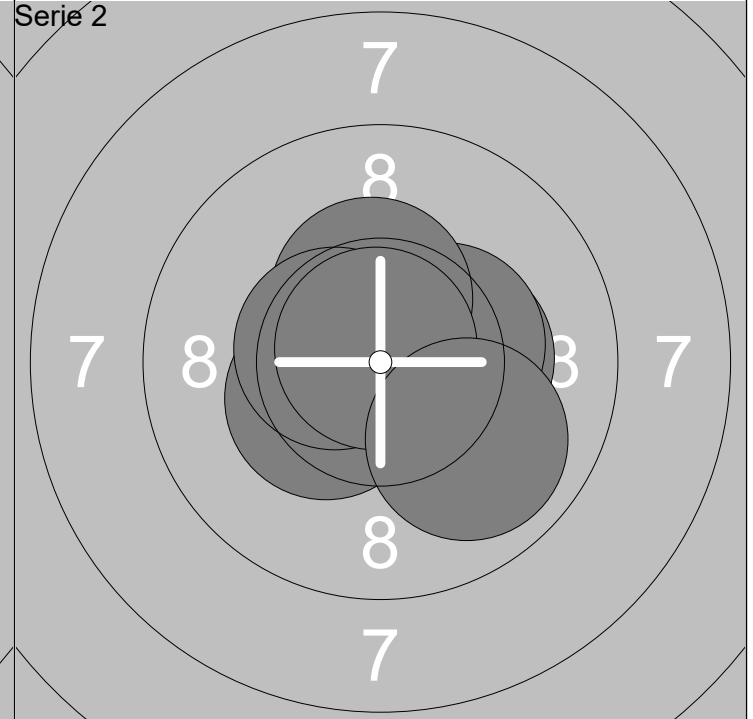
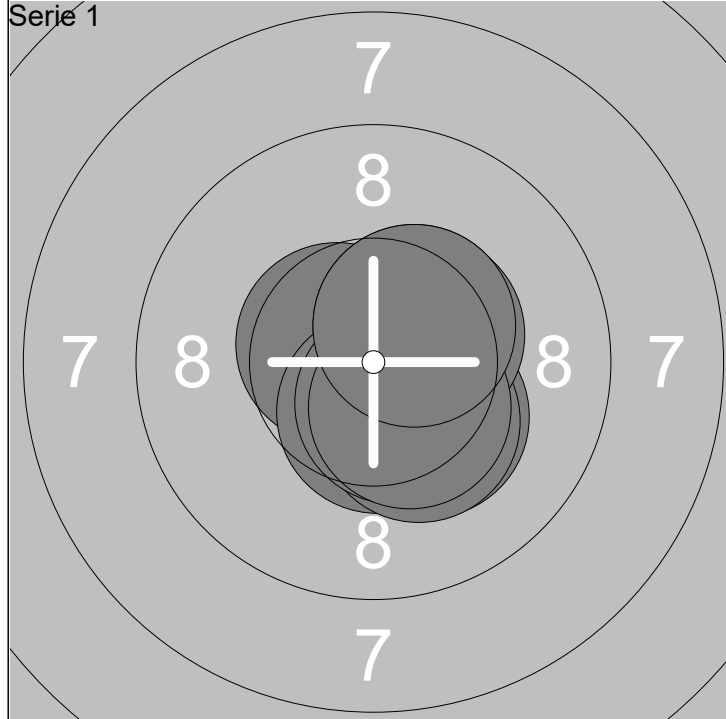

1: 10.6x ↙	6: 10.3x ↘	Serie 104.6
2: 10.5x ↗	7: 10.5x ↗	
3: 10.5x ↓	8: 10.5x ↓	Total 104.6
4: 10.3x ↘	9: 10.4x ↘	
5: 10.5x ↘	10: 10.5x ↗	

11: 10.7x ↗	16: 10.4x ↑	Serie 104.5
12: 10.4x →	17: 10.4x ↙	
13: 10.3x →	18: 10.5x ↙	Total 209.1
14: 10.7x →	19: 10.8x ↑	
15: 10.4x →	20: 9.9 ↘	

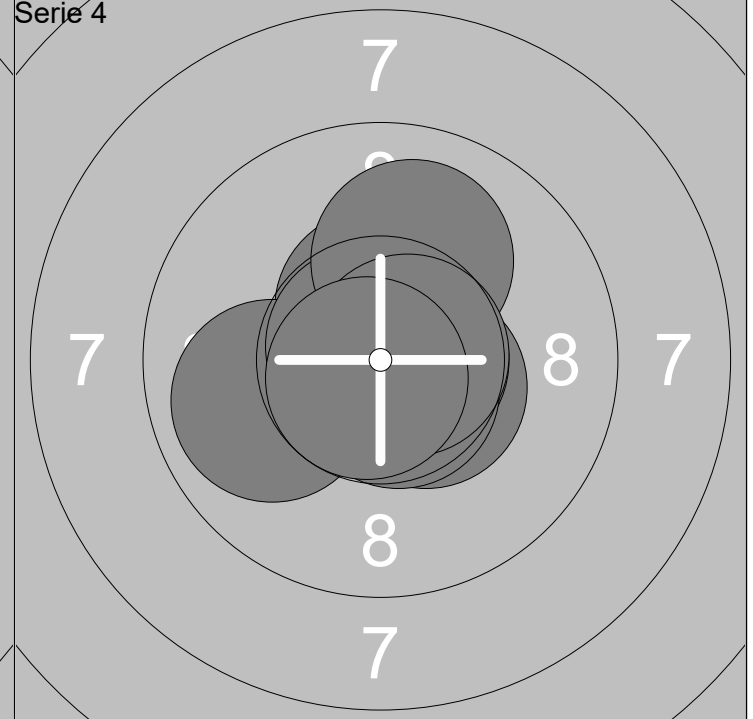
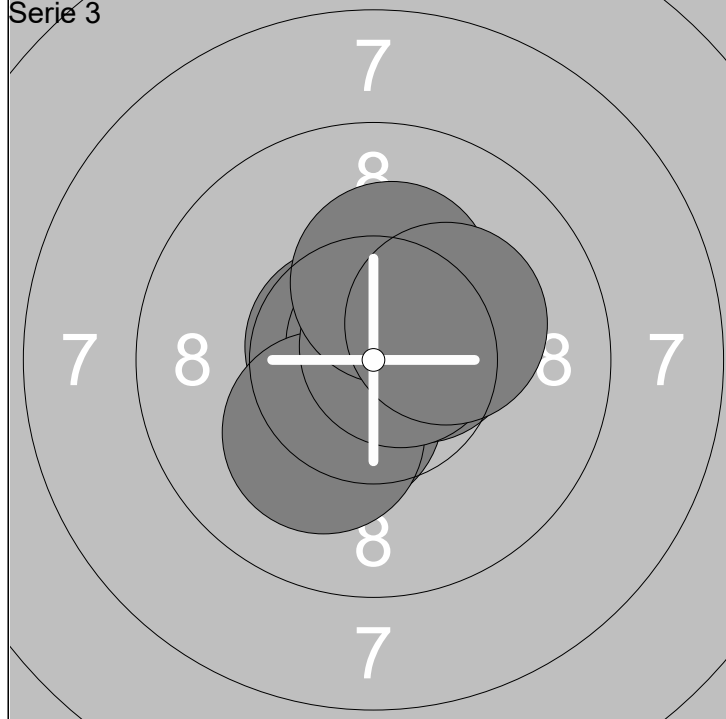

21: 10.4x ↘	26: 10.2x ↘	Serie 105.1
22: 10.7x ↗	27: 10.5x ↗	
23: 10.7x ↙	28: 10.7x ↗	Total 314.2
24: 10.6x ↗	29: 10.3x ↑	
25: 10.8x ↗	30: 10.2x ↗	

31: 10.5x ↘	36: 10.8x ↙	Serie 105.2
32: 10.7x →	37: 10.6x ↘	
33: 10.5x ↑	38: 10.0 ↑	Total 419.4
34: 10.8x →	39: 10.7x →	
35: 9.9 ↙	40: 10.7x ↘	

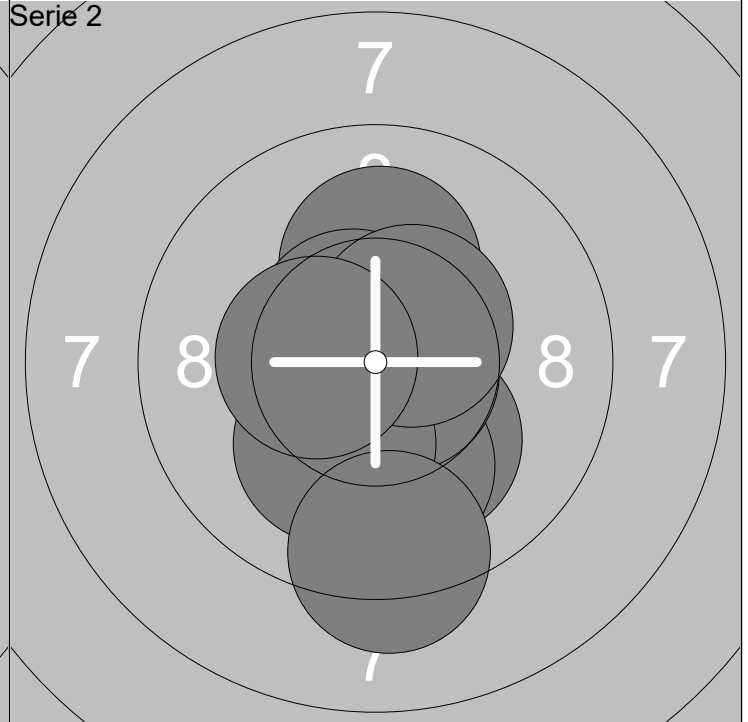
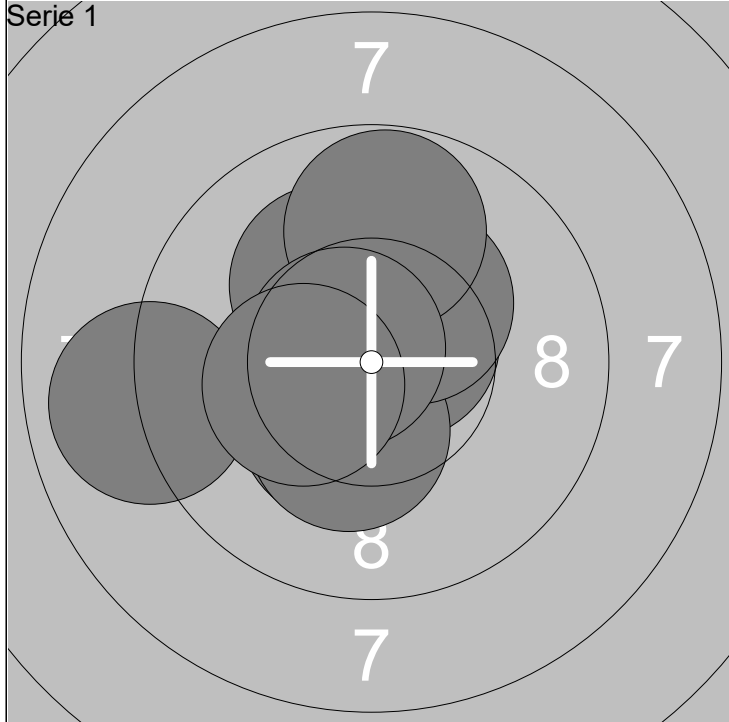

1: 10.6x ↗	6: 10.3x ↓	Serie	102.2
2: 10.4x ↓	7: 10.3x ↗		
3: 10.6x ↗	8: 9.8 ↑	Total	102.2
4: 10.2x ↗	9: 10.7x ↖		
5: 9.0 ←	10: 10.3x ←		

11: 10.2x ↓	16: 10.6x ↗	Serie	102.5
12: 10.0 ↓	17: 10.1 ↓		
13: 10.7x →	18: 10.5x ↗	Total	204.7
14: 10.6x ↗	19: 9.3 ↓		
15: 10.1 ↑	20: 10.4x ←		

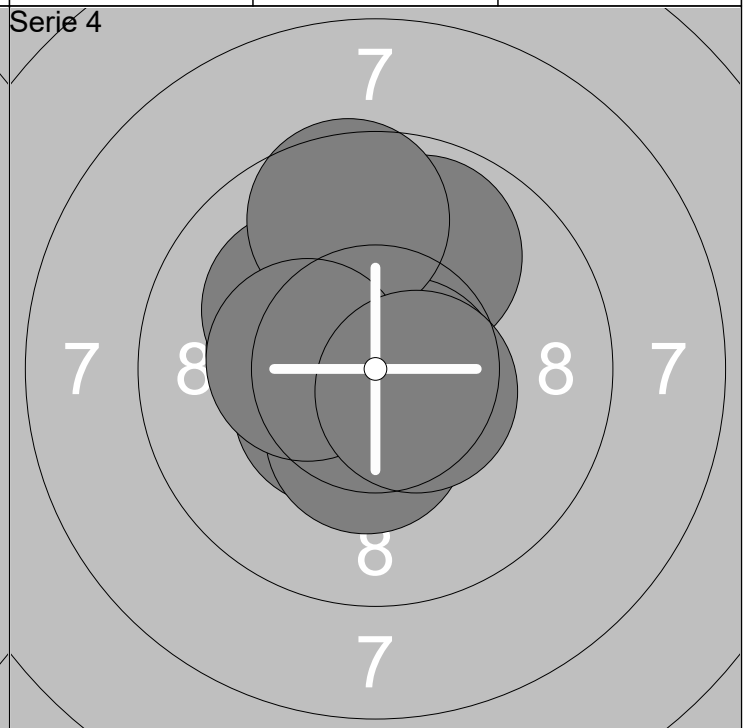
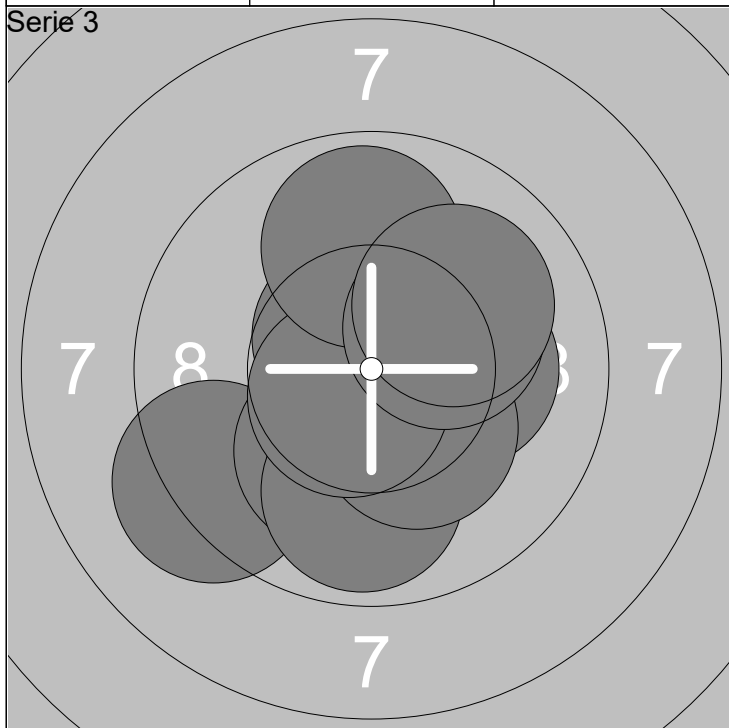

21: 9.2 ←	26: 10.3x ↓	Serie	101.1
22: 10.2x →	27: 10.6x ↓		
23: 10.6x ↗	28: 9.9 ↑	Total	305.8
24: 10.2x ↓	29: 10.2x ↗		
25: 9.9 ↓	30: 10.0 ↗		

31: 10.3x ←	36: 10.1 ↗	Serie	103.1
32: 10.5x ←	37: 9.6 ↑		
33: 10.7x ↓	38: 10.4x ↓	Total	408.9
34: 9.9 ↑	39: 10.4x ←		
35: 10.7x →	40: 10.5x ↓		

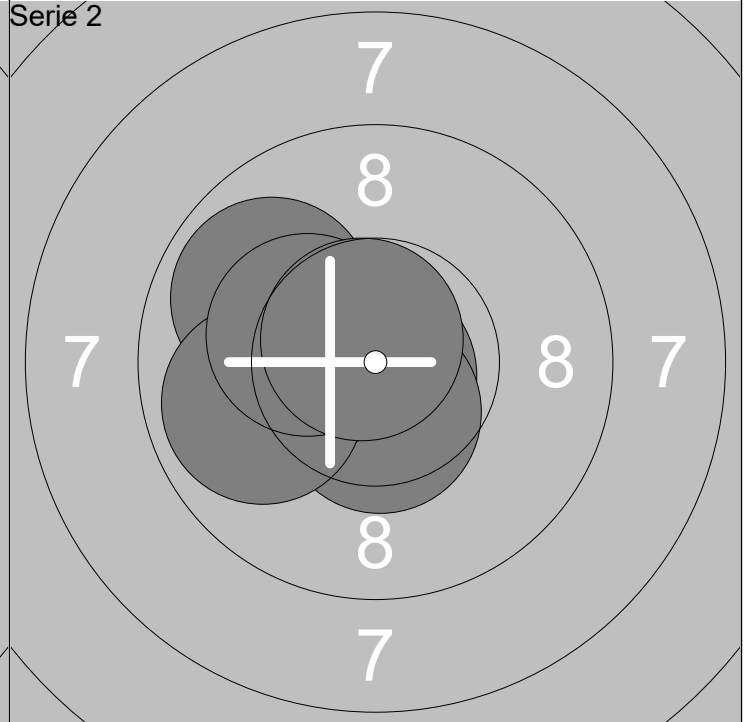
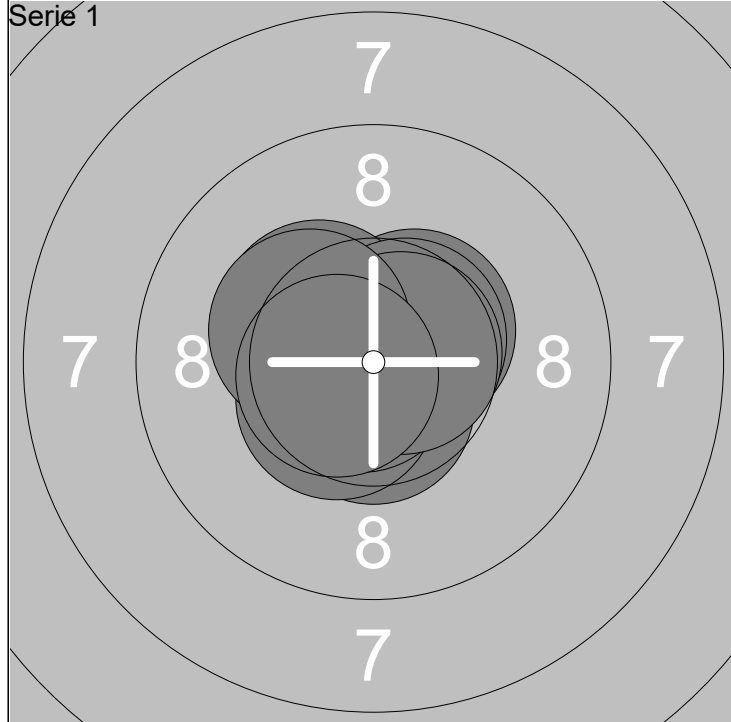

1: 10.5x ↗	6: 10.6x ↗	Serie	105.5
2: 10.3x ↖	7: 10.8x ↙		
3: 10.6x ↓	8: 10.7x →	Total	105.5
4: 10.6x ←	9: 10.3x ↖		
5: 10.5x ↙	10: 10.6x ←		

11: 10.4x ←	16: 10.4x ←	Serie	103.7
12: 10.5x ←	17: 9.9 ↗		
13: 10.8x ↓	18: 9.9 ←	Total	209.2
14: 10.5x ↓	19: 10.3x ↖		
15: 10.3x ↖	20: 10.7x ↗		

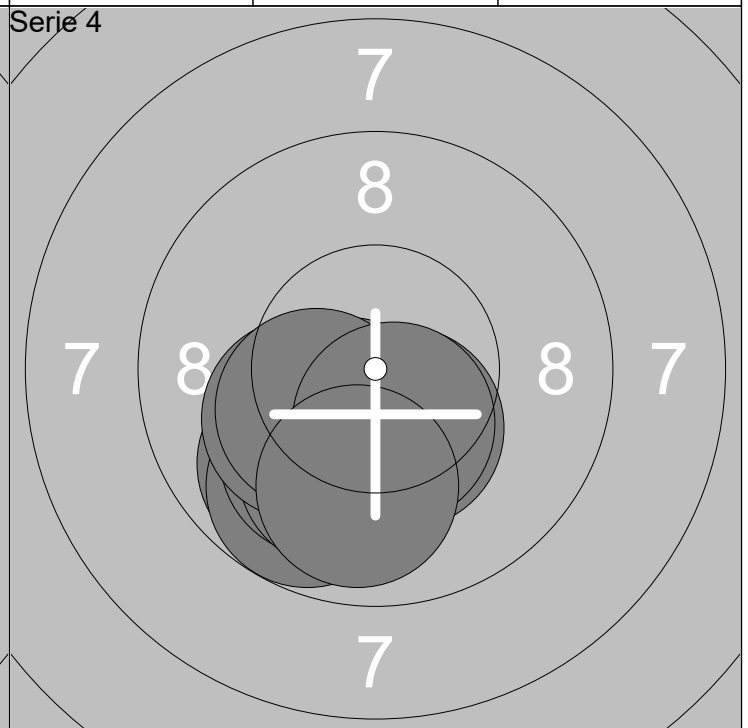
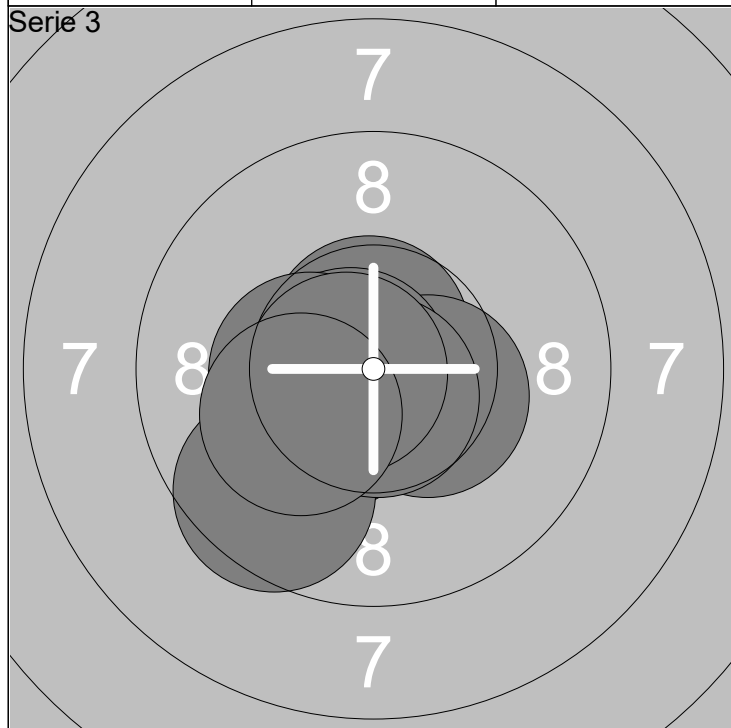

21: 10.7x ↑	26: 10.4x ←	Serie	104.2
22: 10.4x →	27: 9.5 ↙		
23: 10.4x ↙	28: 10.7x ↓	Total	313.4
24: 10.5x ←	29: 10.7x ←		
25: 10.7x ←	30: 10.2x ↙		

31: 9.9 ↙	36: 10.4x ↓	Serie	101.3
32: 10.4x ↙	37: 10.2x ↙		
33: 9.8 ↙	38: 10.3x ↙	Total	414.7
34: 10.0 ↙	39: 10.4x ↓		
35: 10.0 ↙	40: 9.9 ↓		

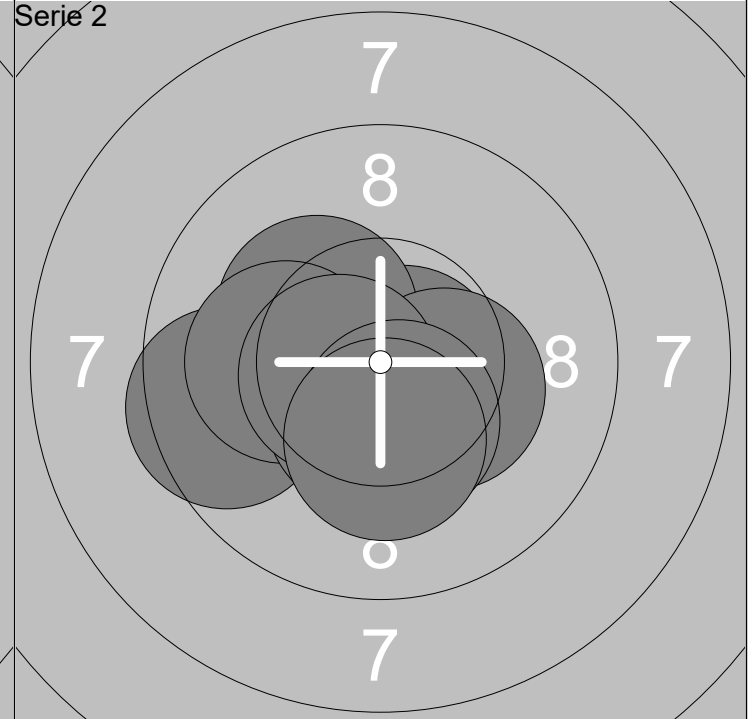
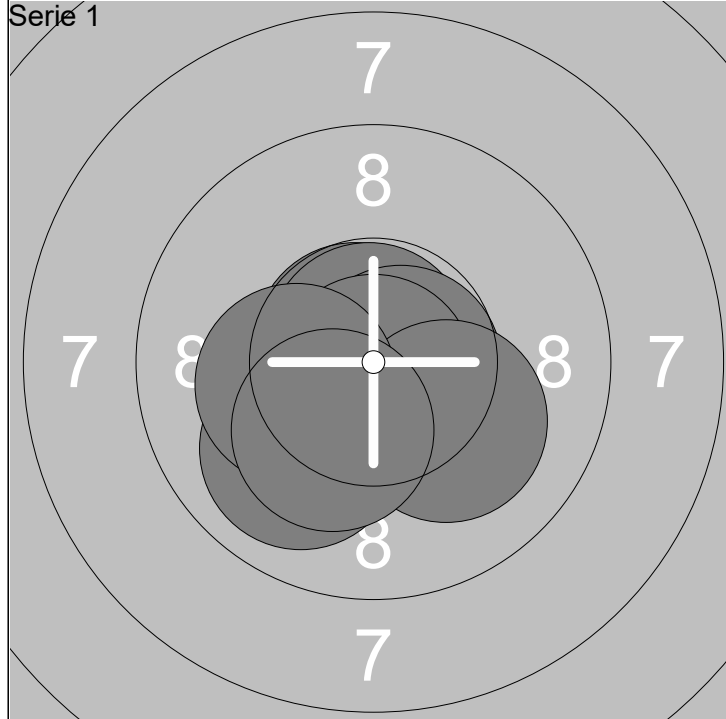

1: 10.7x ↖	6: 10.8x ↓	Serie	104.1
2: 10.8x ↑	7: 10.1 ↘		
3: 10.3x ↙	8: 10.0 ↓	Total	104.1
4: 10.3x ↘	9: 10.2x ←		
5: 10.7x →	10: 10.2x ↙		

11: 10.7x ↓	16: 10.3x →	Serie	103.5
12: 10.8x →	17: 10.5x ↓		
13: 9.5 ←	18: 10.6x ←	Total	207.6
14: 10.3x ↖	19: 10.4x ↓		
15: 10.1 ←	20: 10.3x ↓		

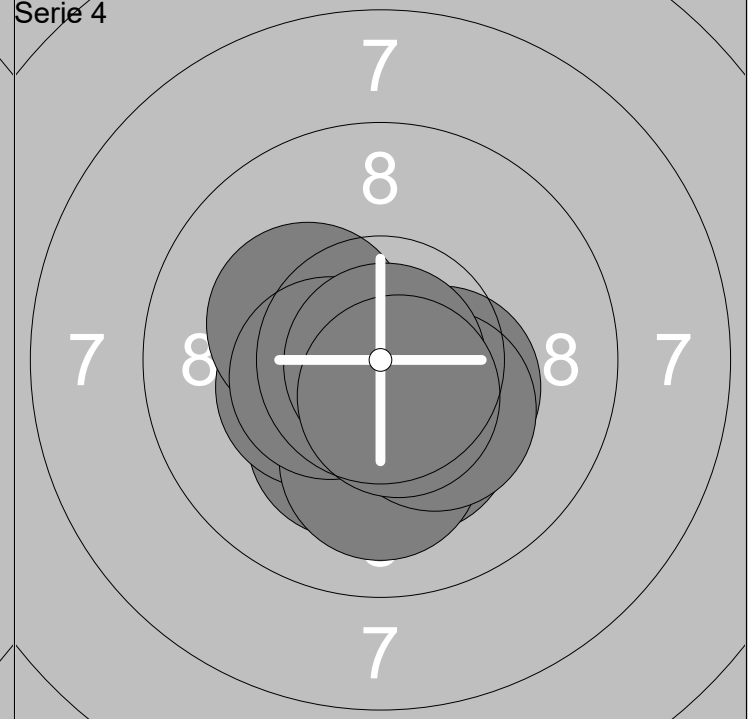
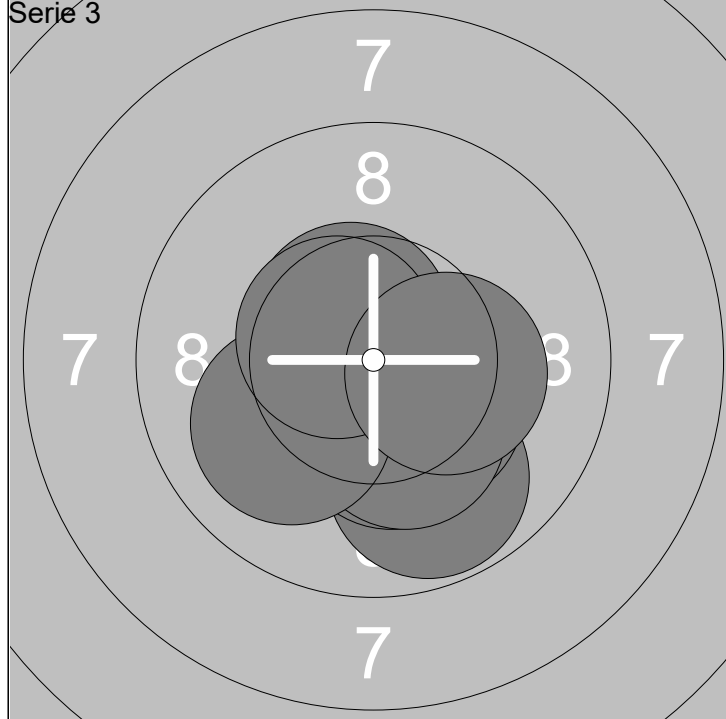

21: 10.7x ←	26: 10.6x ↖	Serie	103.4
22: 9.8 ↓	27: 10.3x ↓		
23: 10.3x ↙	28: 10.0 ←	Total	311.0
24: 10.5x ↘	29: 10.6x ↖		
25: 10.3x ↓	30: 10.3x →		

31: 10.2x ↓	36: 10.3x ↙	Serie	103.7
32: 10.3x ←	37: 10.2x ↖		
33: 10.4x →	38: 10.5x ←	Total	414.7
34: 10.2x ↓	39: 10.9x ↓		
35: 10.1 ↓	40: 10.6x ↓		

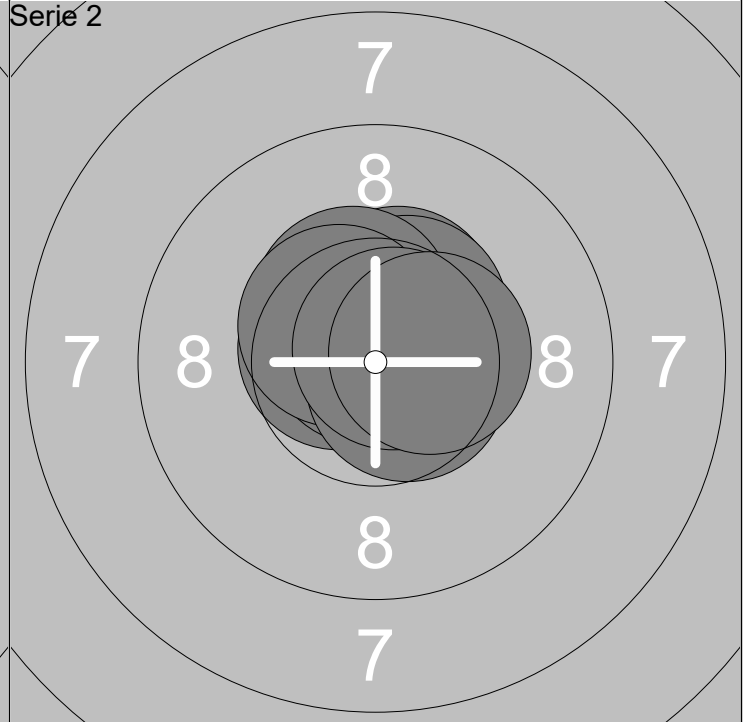
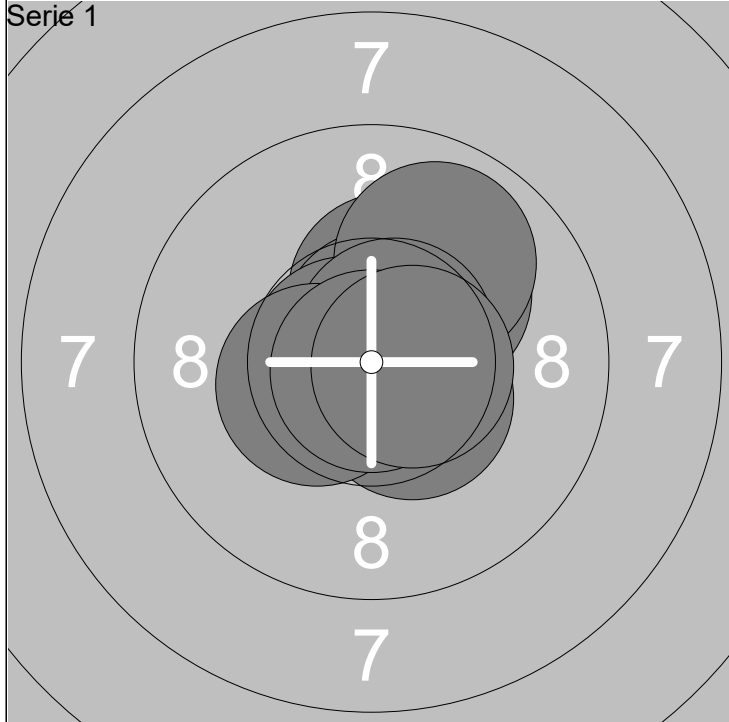

1: 10.3x ↑	6: 10.8x ←	Serie	104.8
2: 10.1 ↗	7: 10.7x ↗		
3: 10.6x ↑	8: 10.4x ←	Total	104.8
4: 10.5x ↘	9: 10.9x ↓		
5: 9.9 ↗	10: 10.6x →		

11: 10.6x ←	16: 10.4x ↑	Serie	105.7
12: 10.8x ↗	17: 10.5x ↗		
13: 10.4x ↑	18: 10.6x ↘	Total	210.5
14: 10.6x ↑	19: 10.8x ↗		
15: 10.5x ↗	20: 10.5x →		

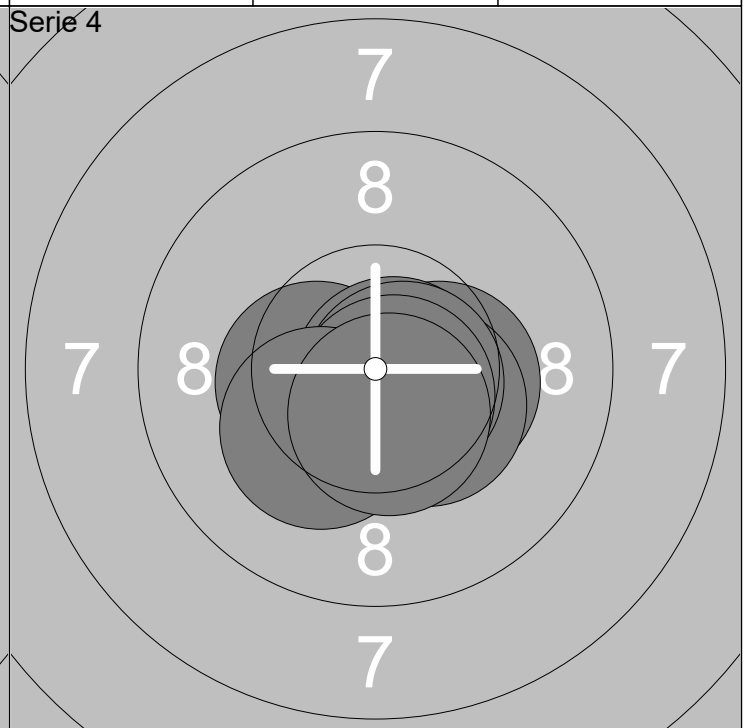
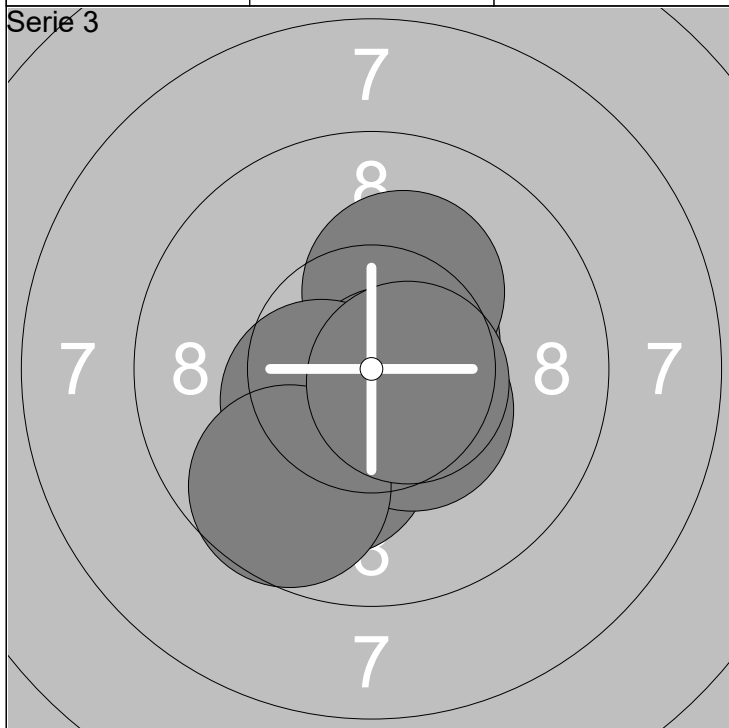

21: 10.4x ↘	26: 10.1 ↓	Serie	103.6
22: 10.6x ↗	27: 10.4x ↘		
23: 10.2x ↑	28: 10.4x ←	Total	314.1
24: 10.7x ↘	29: 9.7 ↓		
25: 10.5x ↘	30: 10.6x →		

31: 10.4x →	36: 10.8x ↘	Serie	105.4
32: 10.5x ↘	37: 10.7x ↘		
33: 10.8x ↓	38: 10.7x ↘	Total	419.5
34: 10.4x ↘	39: 10.2x ↘		
35: 10.4x ←	40: 10.5x ↓		

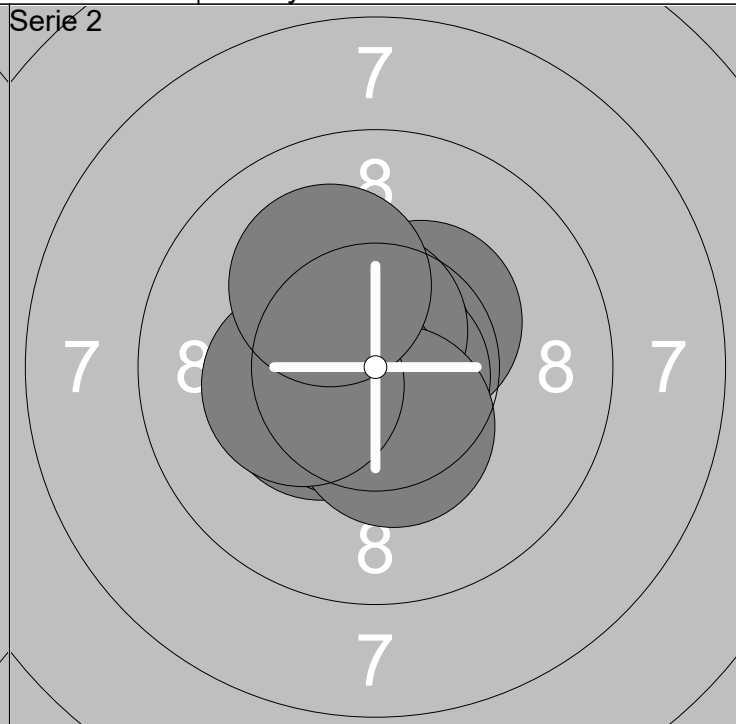
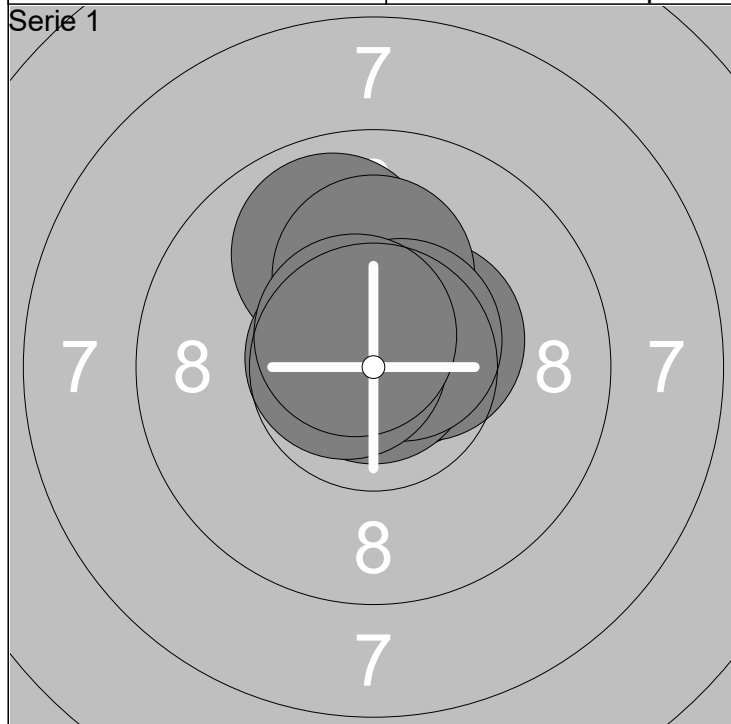

1: 10.6x ↑	6: 10.9x ↑	Serie	105.3
2: 9.9 ↑	7: 10.2x ↑		
3: 10.7x ↑	8: 10.6x ↗	Total	105.3
4: 10.7x ↗	9: 10.7x ←		
5: 10.4x ↗	10: 10.6x ↖		

11: 10.5x ←	16: 10.6x ↑	Serie	104.9
12: 10.4x ↗	17: 10.6x ↘		
13: 10.4x ←	18: 10.4x ↓	Total	210.2
14: 10.8x ↑	19: 10.3x ←		
15: 10.8x ↘	20: 10.1 ↑		

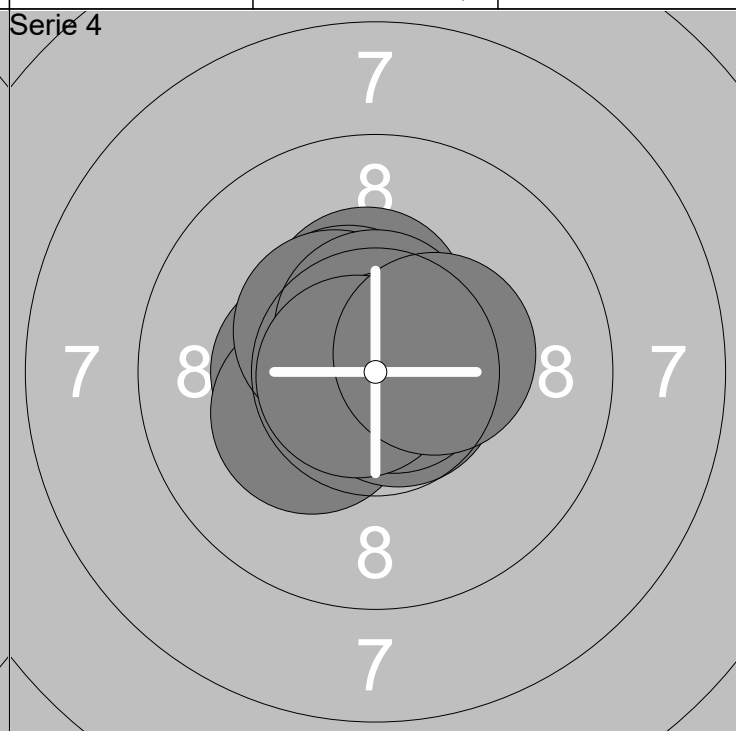
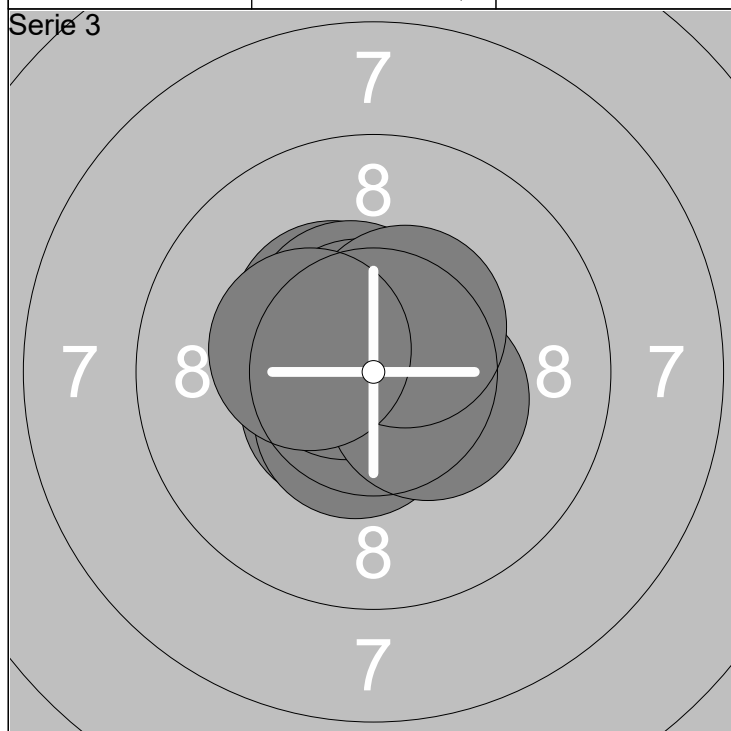

21: 10.6x ↘	26: 10.5x ↓	Serie	105.2
22: 10.4x ↖	27: 10.7x ↖		
23: 10.5x ↑	28: 10.4x ↘	Total	315.4
24: 10.6x ↑	29: 10.5x ↗		
25: 10.6x ↗	30: 10.4x ←		

31: 10.4x ←	36: 10.4x ↖	Serie	105.3
32: 10.3x ←	37: 10.6x ↑		
33: 10.4x ↑	38: 10.8x →	Total	420.7
34: 10.7x ↘	39: 10.8x ←		
35: 10.5x ↖	40: 10.4x →		

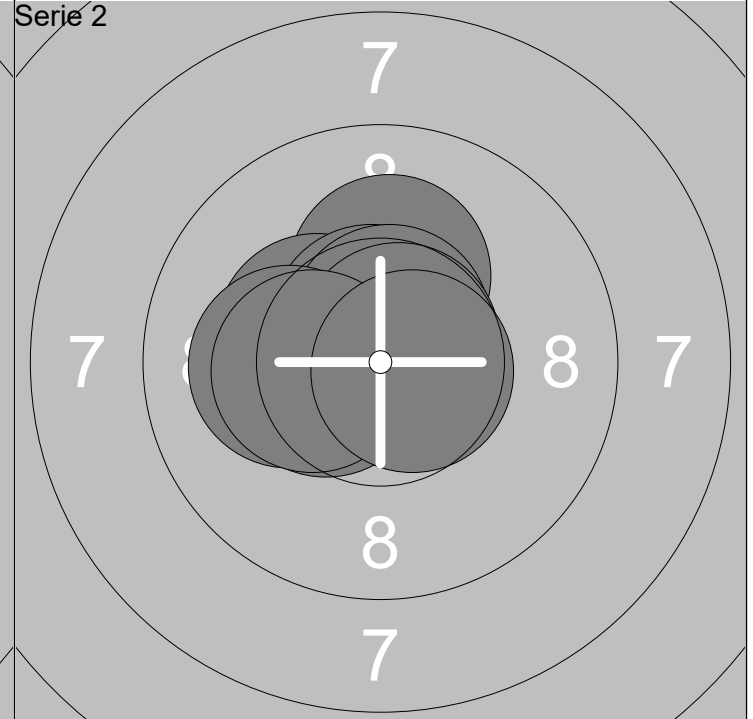
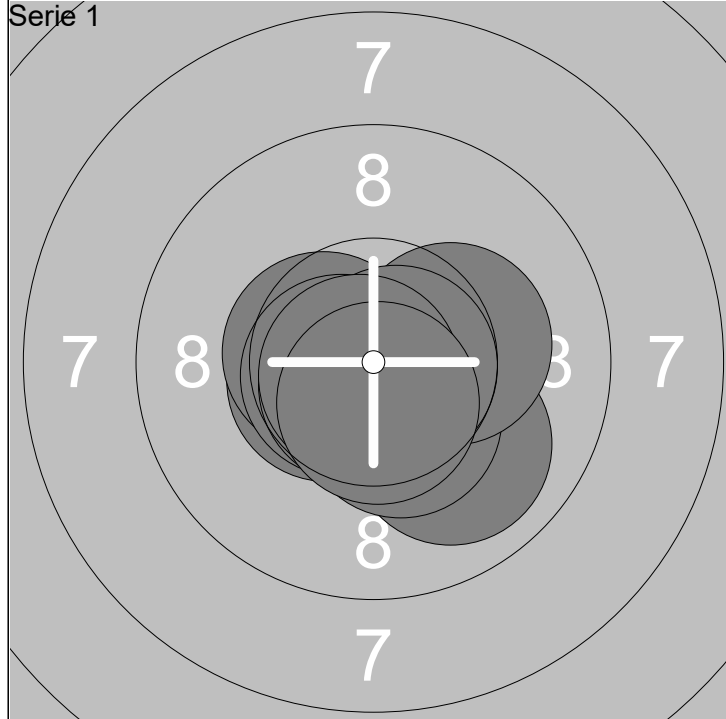

1: 10.0 ↘	6: 10.7x ←	Serie	105.2
2: 10.4x ↘	7: 10.7x →		
3: 10.5x ←	8: 10.7x ↙	Total	105.2
4: 10.3x →	9: 10.8x ↙		
5: 10.5x ←	10: 10.6x ↓		

11: 10.2x ↑	16: 10.6x ↑	Serie	104.9
12: 10.8x ↗	17: 10.7x ↗		
13: 10.4x ←	18: 10.1 ←	Total	210.1
14: 10.6x ↑	19: 10.3x ←		
15: 10.5x ←	20: 10.7x →		

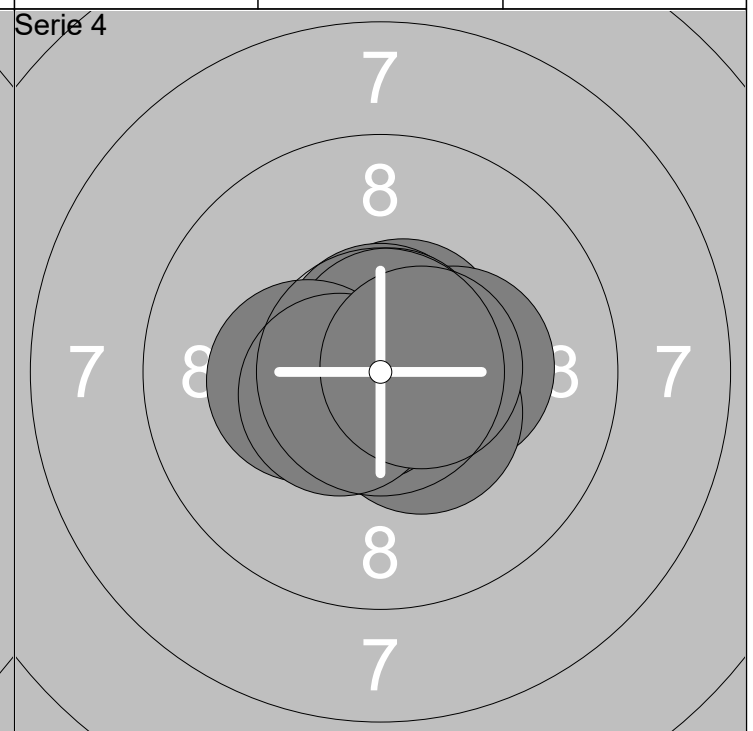
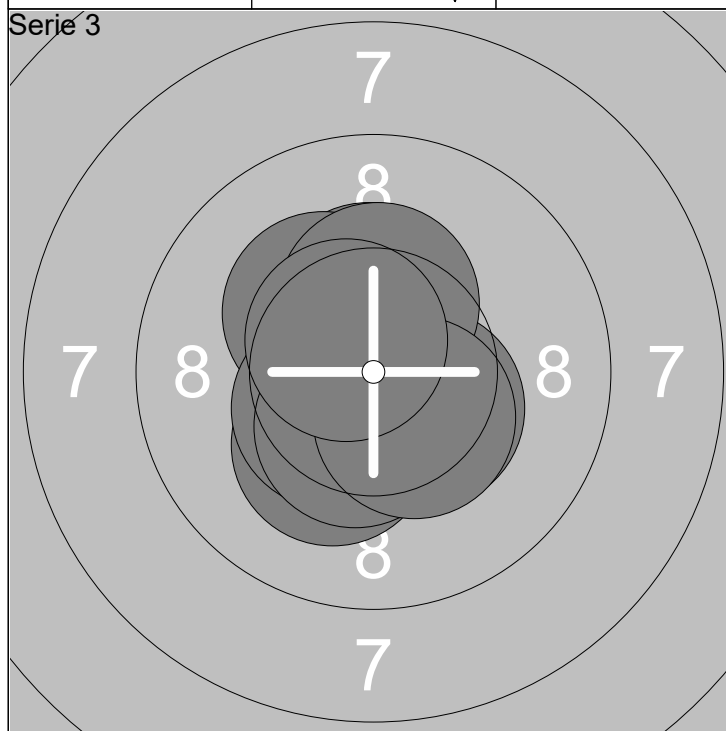

21: 10.3x ↑	26: 10.5x ←	Serie	104.0
22: 10.3x ↗	27: 10.3x ↑		
23: 10.2x ↙	28: 10.4x ↙	Total	314.1
24: 10.4x ↘	29: 10.4x ↘		
25: 10.6x ↙	30: 10.6x ↗		

31: 10.6x ↗	36: 10.8x ←	Serie	105.8
32: 10.9x ↑	37: 10.7x ↑		
33: 10.7x ↑	38: 10.3x ←	Total	419.9
34: 10.3x →	39: 10.5x ←		
35: 10.4x ↘	40: 10.6x →		



Skjutlag

3

Tavla

2

Tony Björnsson

Rottne Industri Cup 2019

Värnamo Skytteförening

Ösm

26.10.2019

Rottne Industri Cup 2019

Söraby SKF

Serie 1

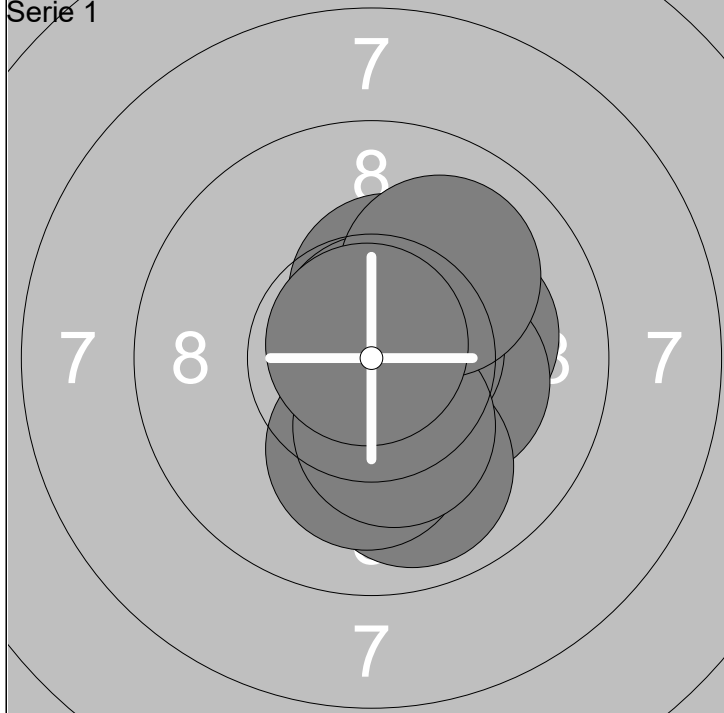

Serie 2

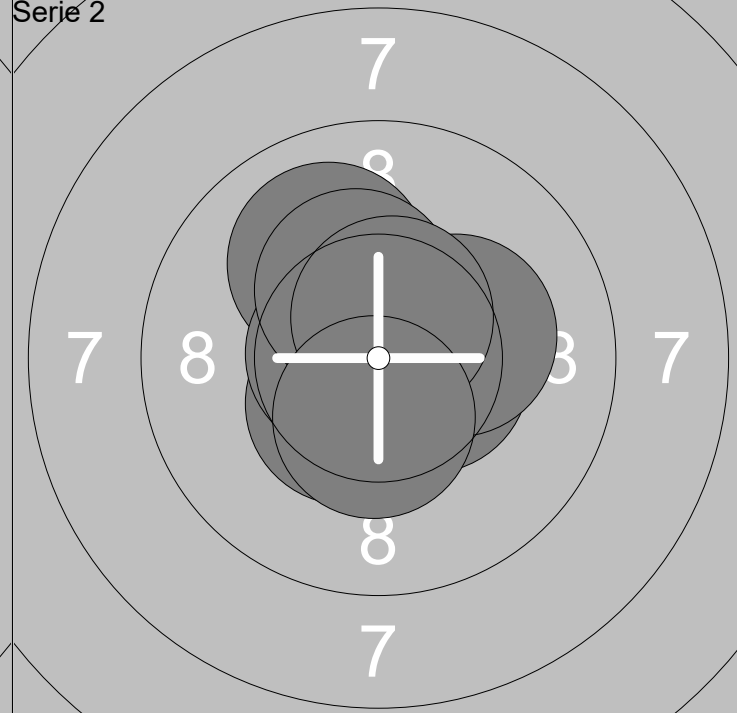

1: 10.1 →  
2: 10.2x →  
3: 9.9 ↓  
4: 10.1 ↓  
5: 10.4x ↑

6: 10.8x ↑  
7: 10.6x →  
8: 10.3x ↓  
9: 10.0 ↗  
10: 10.8x ↑

Serie 103.2  
Total 103.2

11: 10.0 ↖  
12: 10.5x →  
13: 10.2x →  
14: 10.4x ↙  
15: 10.6x ↑

16: 10.7x ←  
17: 10.7x ←  
18: 10.3x ↗  
19: 10.6x ↑  
20: 10.4x ↓

Serie 104.4  
Total 207.6

Serie 3

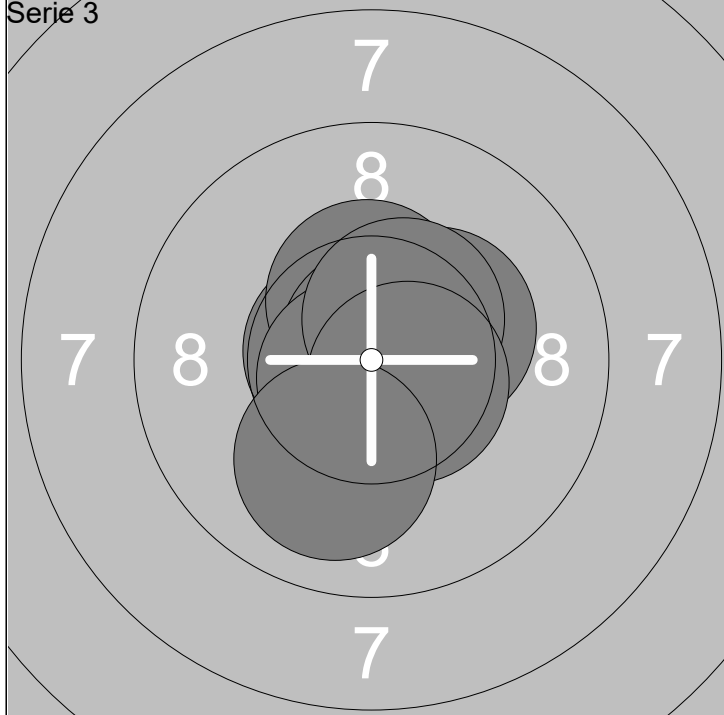

Serie 4

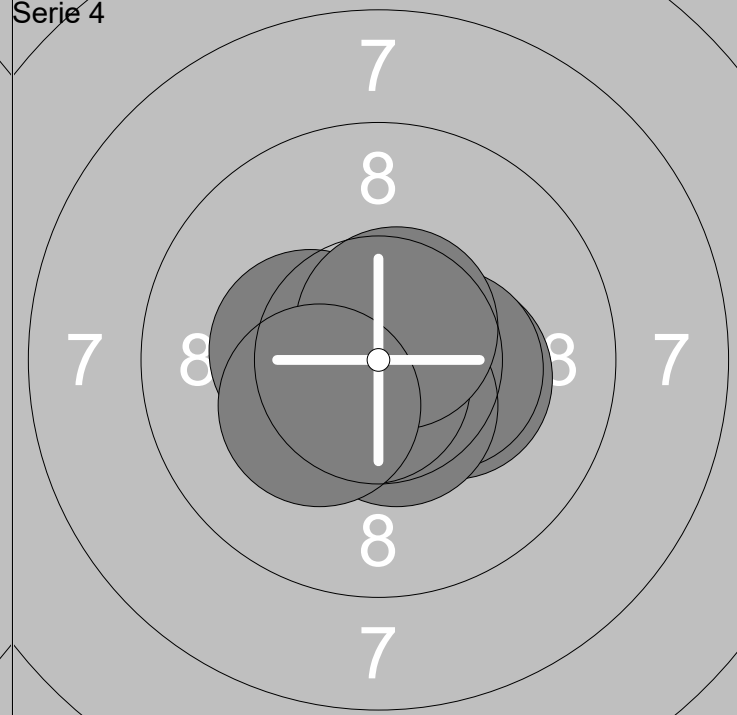

21: 10.7x ←  
22: 10.7x →  
23: 10.6x ↗  
24: 10.4x ↑  
25: 10.3x ↗

26: 10.8x ↗  
27: 10.8x ↙  
28: 10.5x ↗  
29: 10.6x ↘  
30: 10.0 ↓

Serie 105.4  
Total 313.0

31: 10.6x ↓  
32: 10.5x ←  
33: 10.8x ↗  
34: 10.3x ←  
35: 10.3x →

36: 10.4x →  
37: 10.5x ↓  
38: 10.7x ↙  
39: 10.6x ↗  
40: 10.3x ↙

Serie 105.0  
Total 418.0

Rottne Industri Cup 2019

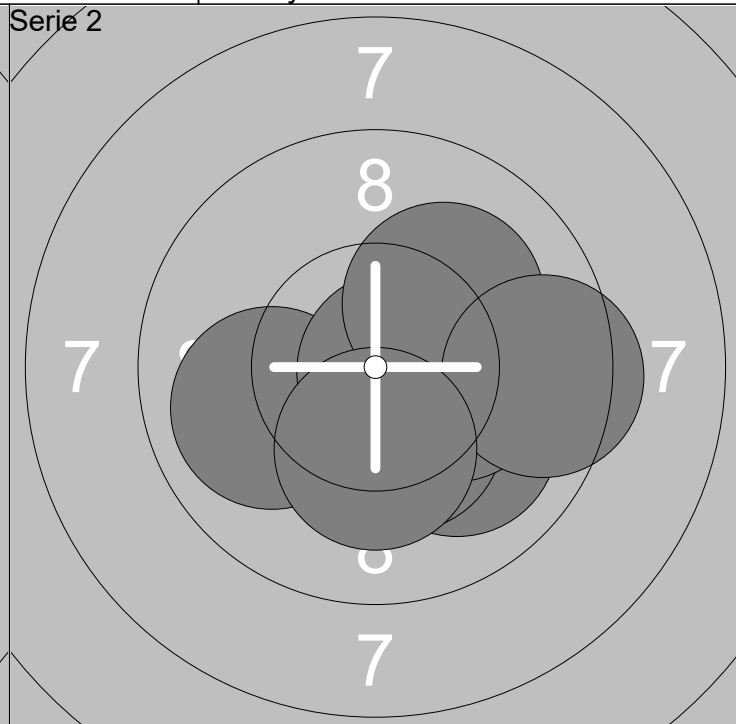
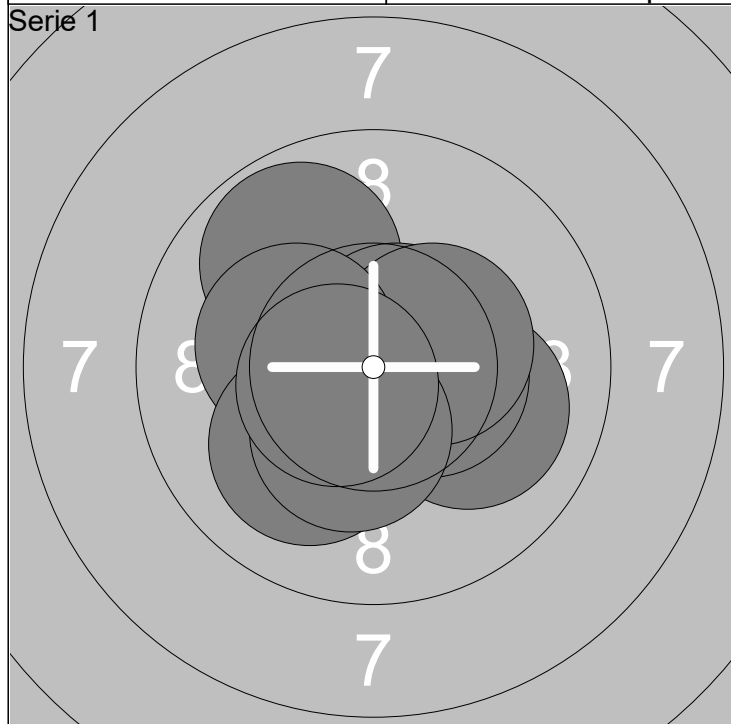

1: 9.8 ↗	6: 10.4x →	Serie 103.5
2: 10.1 →	7: 10.2x ←	
3: 10.7x ←	8: 10.1 ↘	Total 103.5
4: 10.7x ↗	9: 10.4x ↘	
5: 10.5x →	10: 10.6x ←	

11: 10.6x ↘	16: 10.2x →	Serie 102.2
12: 10.0 ↘	17: 10.7x →	
13: 10.0 ←	18: 10.2x ↗	Total 205.7
14: 10.3x ↘	19: 9.5 →	
15: 10.5x →	20: 10.2x ↘	

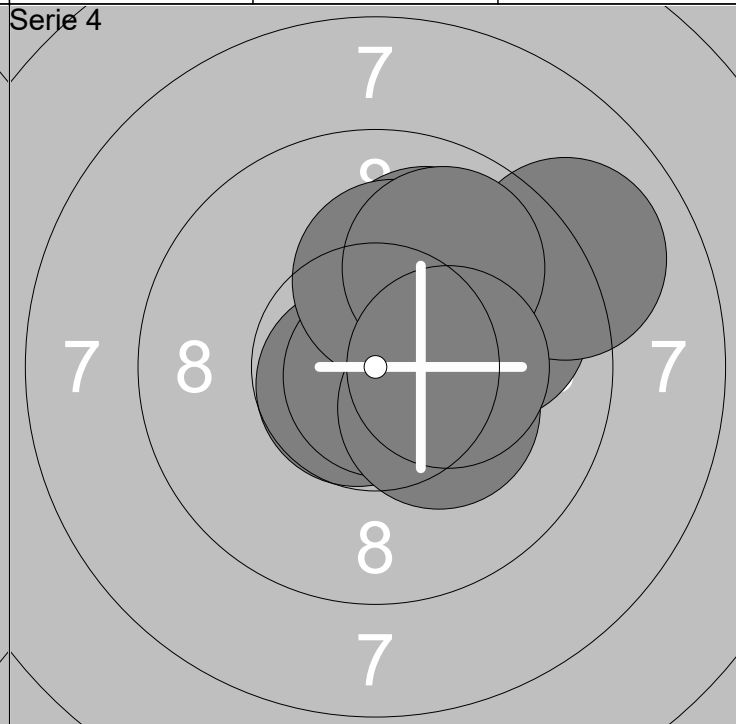
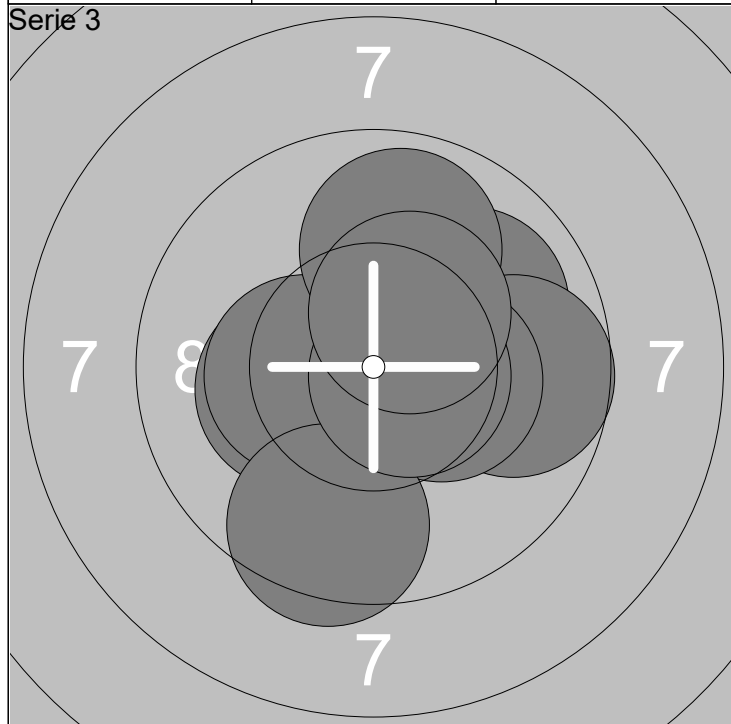

21: 10.0 ↗	26: 9.9 ↑	Serie 101.7
22: 10.8x ↘	27: 10.3x →	
23: 10.2x ←	28: 9.5 ↘	Total 307.4
24: 10.3x ←	29: 10.6x →	
25: 9.7 →	30: 10.4x ↗	

31: 10.2x ↗	36: 10.2x ↑	Serie 101.3
32: 10.7x ↘	37: 9.0 ↗	
33: 10.0 ↑	38: 10.3x ↘	Total 408.7
34: 10.8x ↘	39: 9.9 ↗	
35: 9.9 →	40: 10.3x →	

Skjutlag

3

Tavla

4

Tony Pettersson

Rottne Industri Cup 2019

Karlslunda Ungdomsskyttefören

Ösm

26.10.2019

Rottne Industri Cup 2019

Söraby SKF

Serie 1

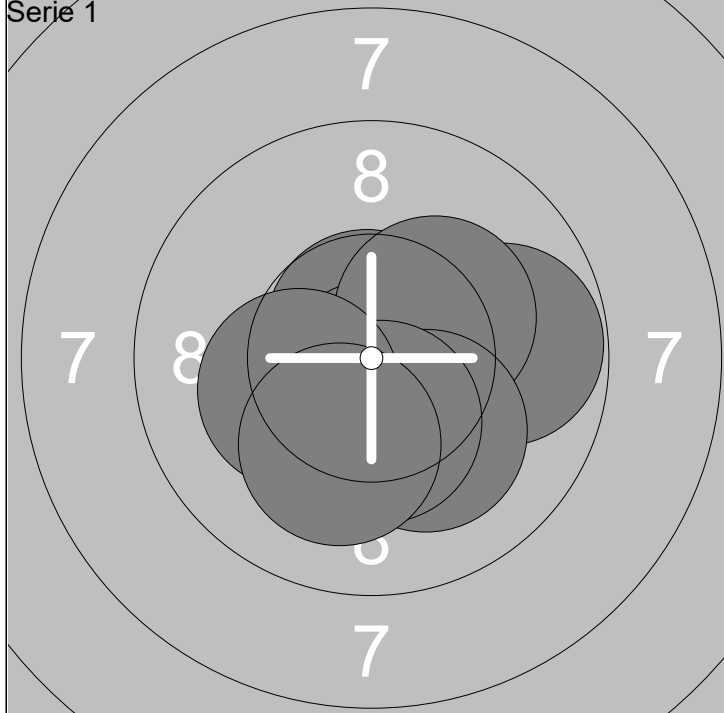

Serie 2

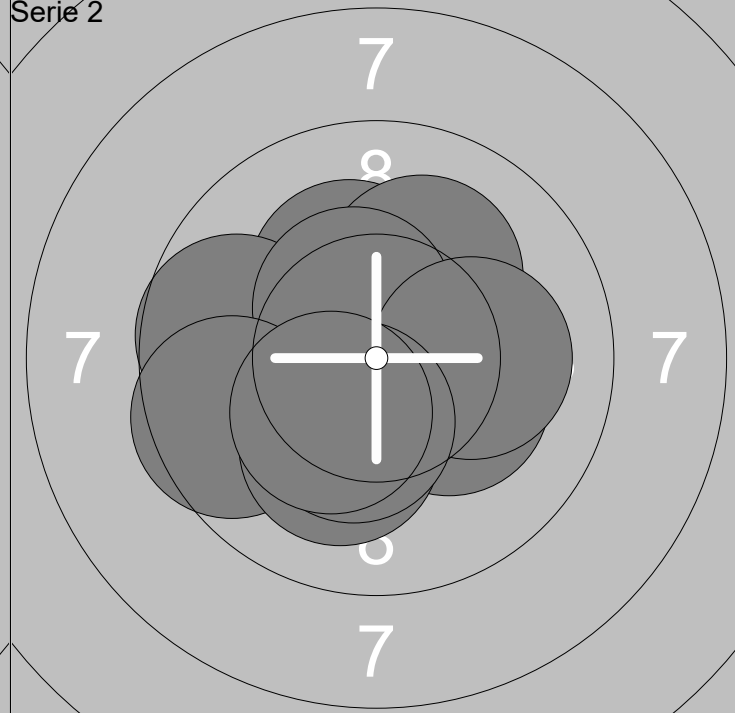

1: 10.3x →	6: 10.3x ↗
2: 10.4x →	7: 10.2x ↘
3: 10.7x ↑	8: 10.4x ↓
4: 9.8 →	9: 10.3x ←
5: 10.7x ↓	10: 10.1 ↓

Serie	103.2
Total	103.2

11: 10.2x ↖	16: 10.1 →
12: 9.7 ←	17: 9.5 ←
13: 10.1 ↗	18: 10.1 ↓
14: 10.5x ↖	19: 10.4x ↓
15: 10.2x →	20: 10.3x ↘

Serie	101.1
Total	204.3

Serie 3

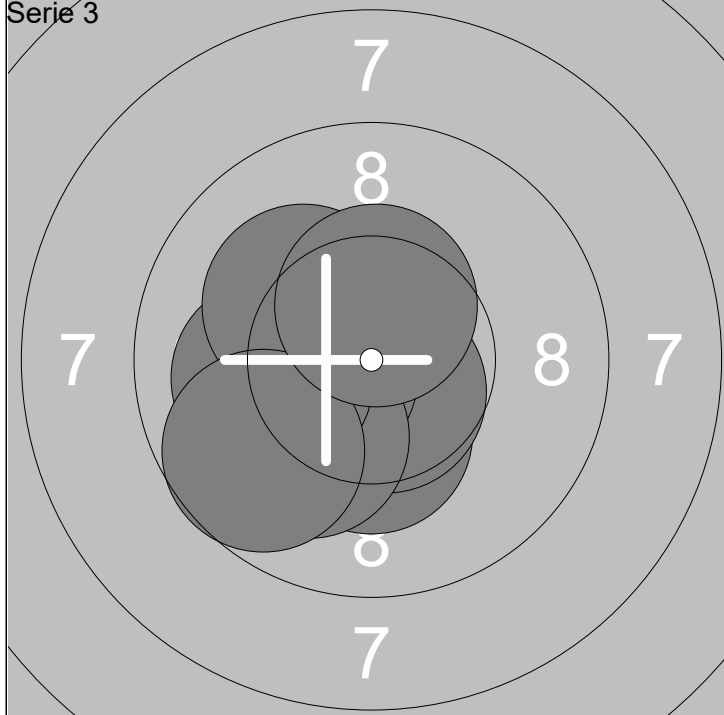

Serie 4

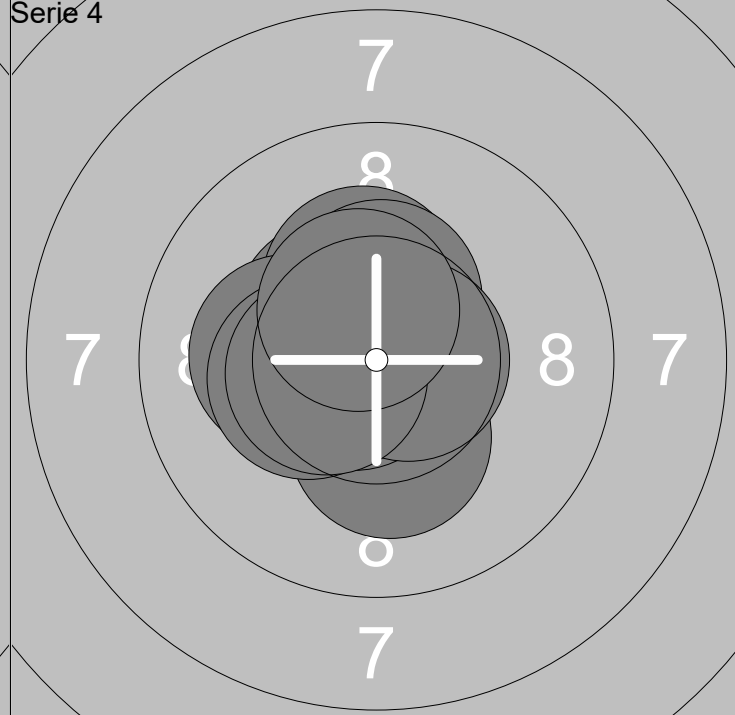

21: 10.3x ↓	26: 10.1 ↘
22: 10.6x ↓	27: 10.1 ←
23: 10.3x ←	28: 10.2x ↖
24: 10.4x ↖	29: 9.7 ↘
25: 10.5x ←	30: 10.5x ↑

Serie	102.7
Total	307.0

31: 10.3x ↓	36: 10.7x →
32: 10.7x ←	37: 10.2x ←
33: 10.4x ↖	38: 10.3x ←
34: 10.3x ↑	39: 10.5x ←
35: 10.4x ↑	40: 10.5x ↖

Serie	104.3
Total	411.3

Rottne Industri Cup 2019

Skjutlag

3

Tavla

5

Camilla Karlsson

Rottne Industri Cup 2019

Karlslunda Ungdomsskyttefören

Ösm

26.10.2019

Rottne Industri Cup 2019

Söraby SKF

Serie 1

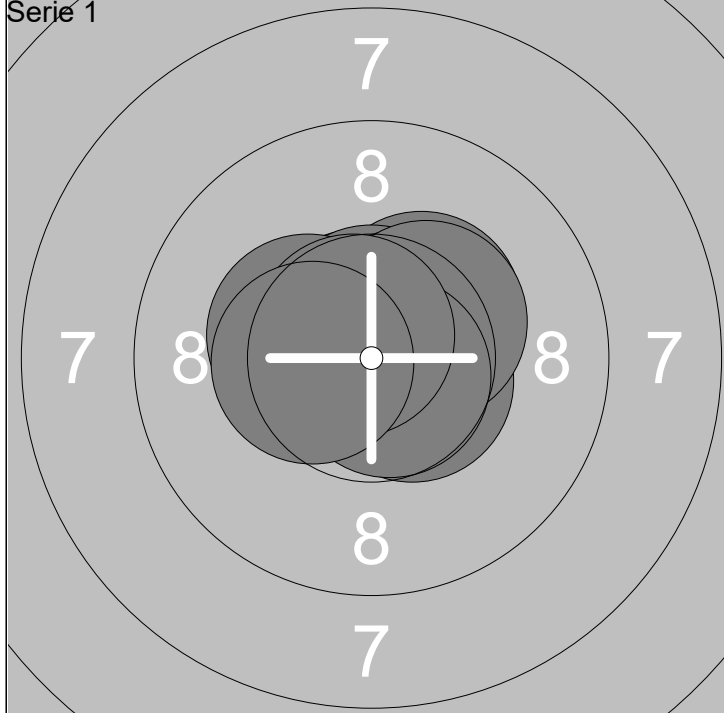

Serie 2

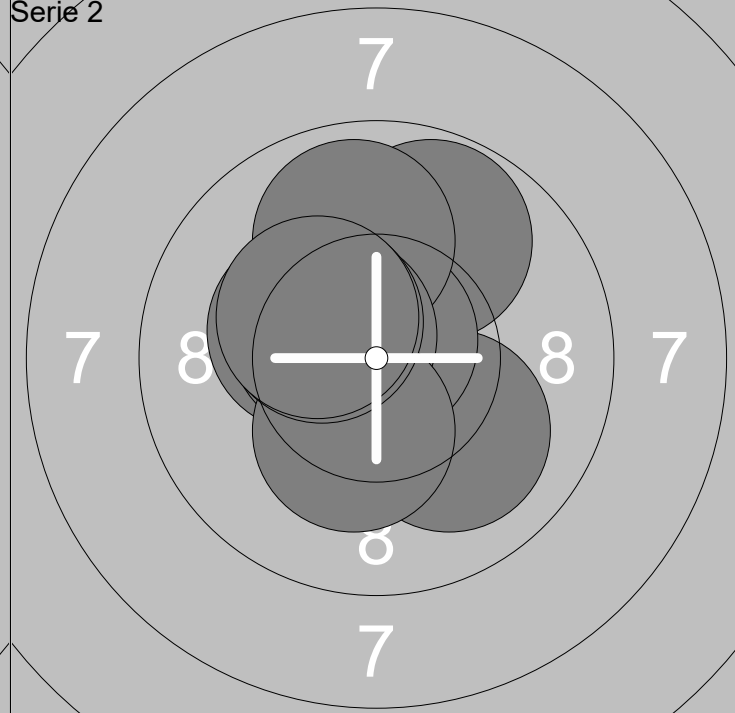

1: 10.7x ↖  
2: 10.3x ↗  
3: 10.7x ↑  
4: 10.5x ↘  
5: 10.6x ↗

6: 10.4x ↗  
7: 10.4x ↖  
8: 10.7x ↘  
9: 10.7x ↗  
10: 10.4x ↖

Serie 105.4

Total 105.4

11: 10.0 ↘  
12: 10.3x ↖  
13: 9.8 ↑  
14: 10.8x ↑  
15: 9.9 ↑

16: 10.5x ↖  
17: 10.5x ↖  
18: 10.3x ↘  
19: 10.4x ↖  
20: 10.3x ↖

Serie 102.8

Total 208.2

Serie 3

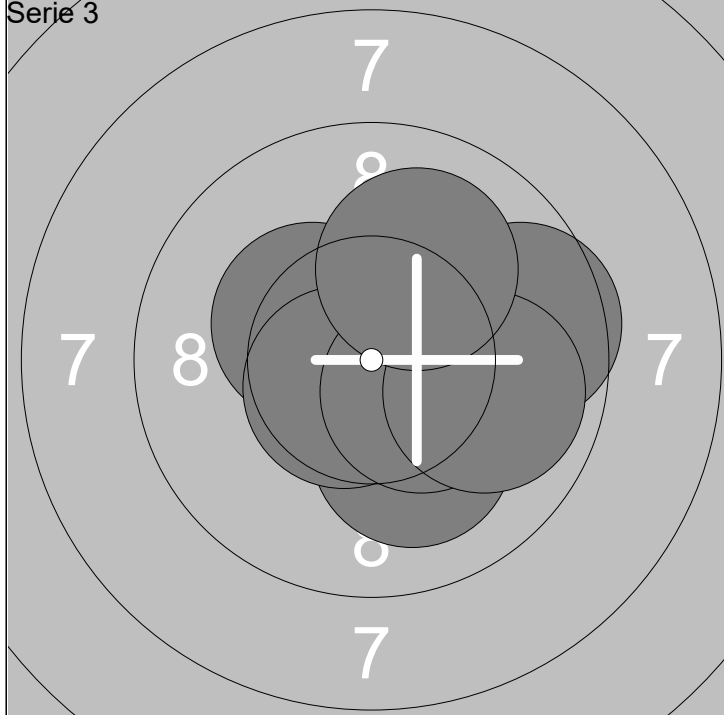

Serie 4

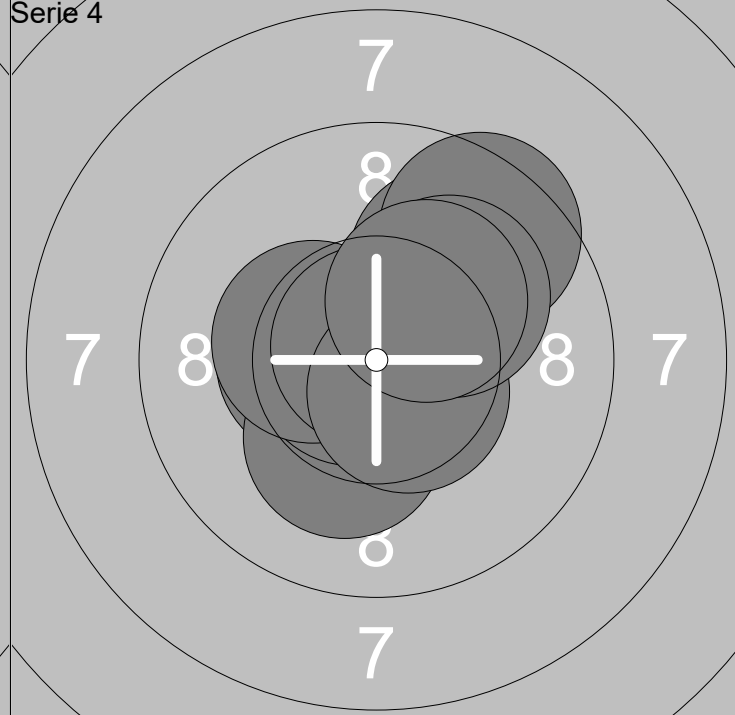

21: 10.3x ↖  
22: 10.7x ↘  
23: 10.4x ↘  
24: 10.1 ↘  
25: 9.6 →

26: 10.6x ↖  
27: 10.1 →  
28: 10.4x ↘  
29: 9.9 →  
30: 10.0 ↗

Serie 102.1

Total 310.3

31: 10.4x ↖  
32: 10.2x ↘  
33: 9.9 ↗  
34: 10.8x ↖  
35: 10.4x ↖

36: 10.8x ↗  
37: 9.5 ↗  
38: 10.6x ↘  
39: 10.1 ↗  
40: 10.3x ↗

Serie 103.0

Total 413.3

Rottne Industri Cup 2019

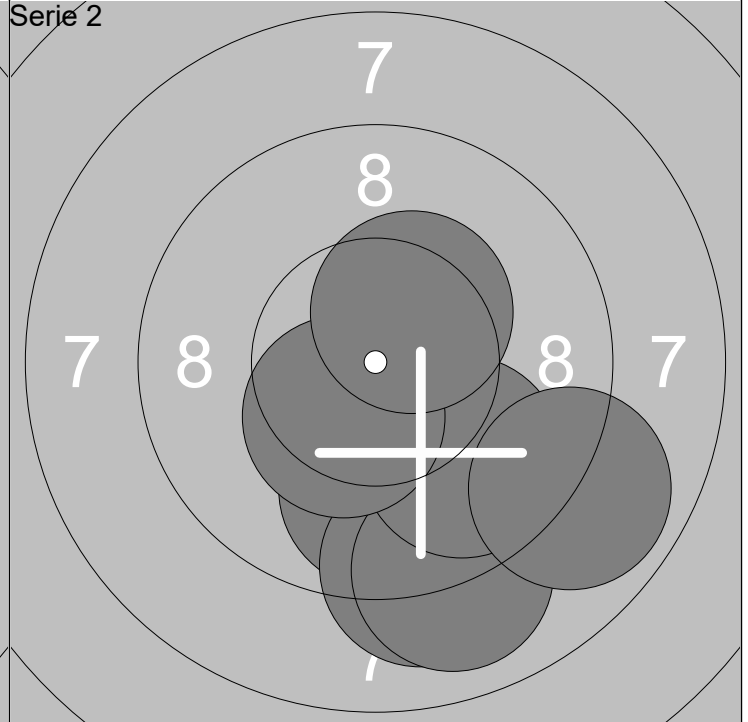
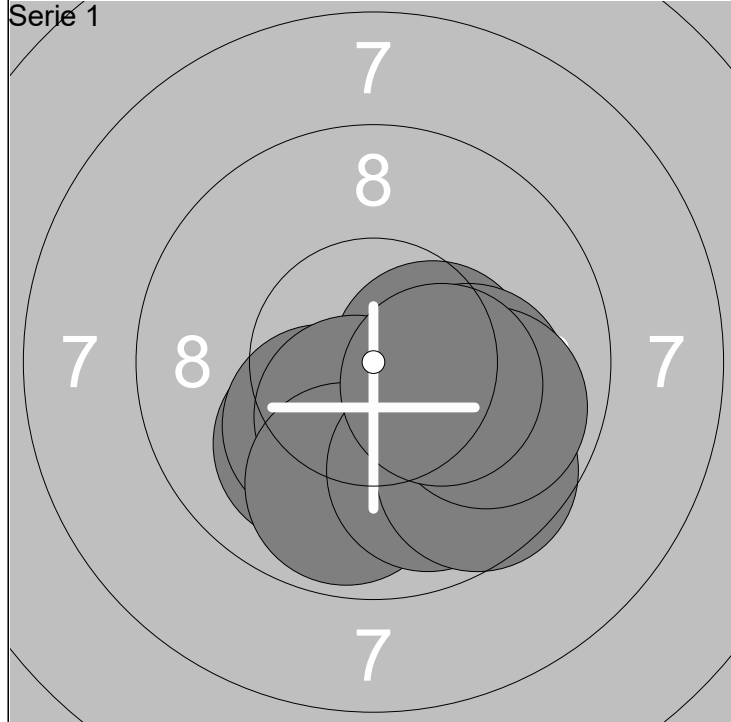

1: 10.1 ↙	6: 9.8 ↓	Serie	100.8
2: 10.2x ↙	7: 9.9 ↓		
3: 10.4x →	8: 9.6 ↓	Total	100.8
4: 10.5x ↓	9: 9.9 ↓		
5: 10.1 →	10: 10.3x ↘		

11: 9.9 ↓	16: 9.0 ↓	Serie	97.0
12: 9.8 ↓	17: 9.8 ↓		
13: 9.8 ↓	18: 8.9 ↓	Total	197.8
14: 9.1 ↓	19: 10.4x ↓		
15: 9.9 ↓	20: 10.4x ↗		

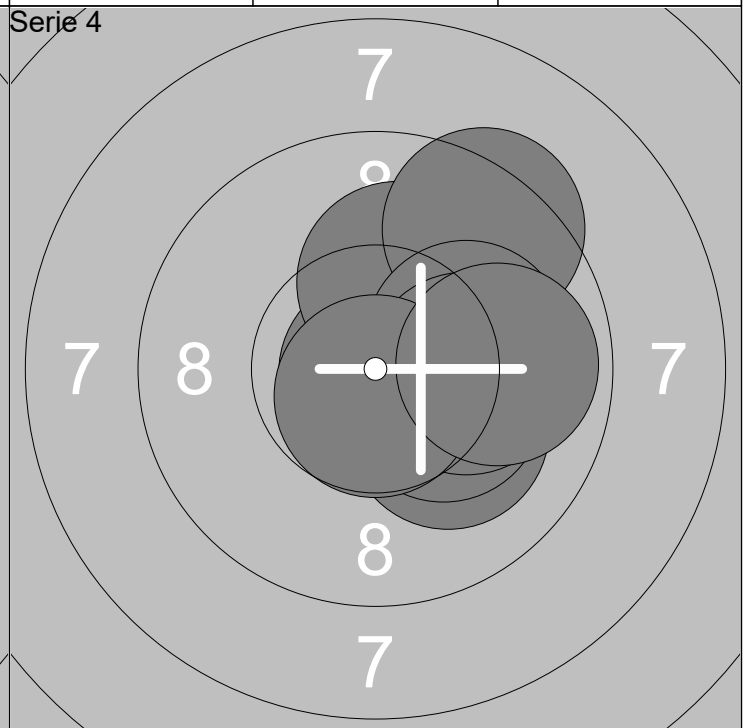
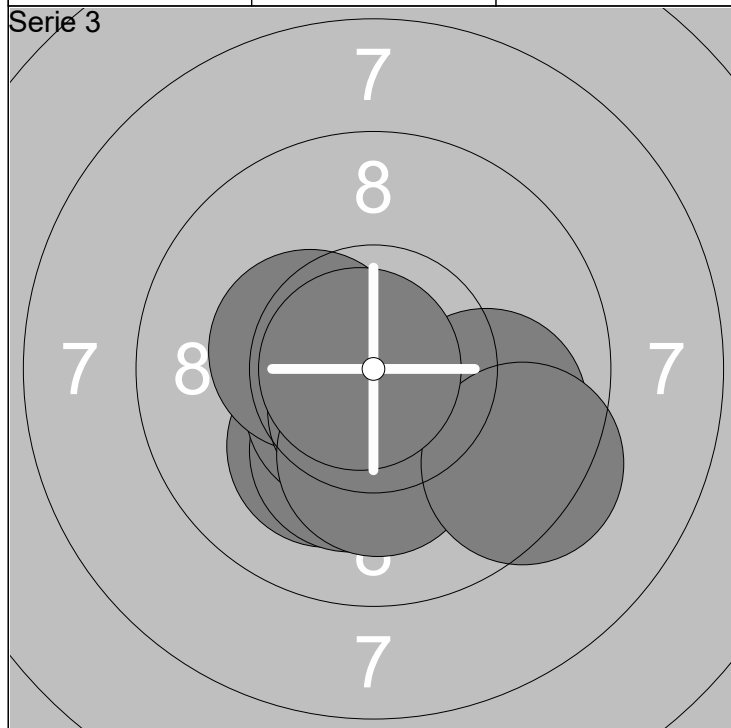

21: 10.2x ↙	26: 10.6x ↓	Serie	102.8
22: 10.6x ←	27: 9.9 →		
23: 10.2x ↓	28: 10.2x ↓	Total	300.6
24: 10.5x ↙	29: 9.4 ↓		
25: 10.4x ←	30: 10.8x ←		

31: 10.3x ↗	36: 9.4 ↗	Serie	102.1
32: 10.9x ↓	37: 10.1 →		
33: 10.2x ↑	38: 10.2x →	Total	402.7
34: 10.1 ↓	39: 10.7x ↓		
35: 10.3x ↘	40: 9.9 →		

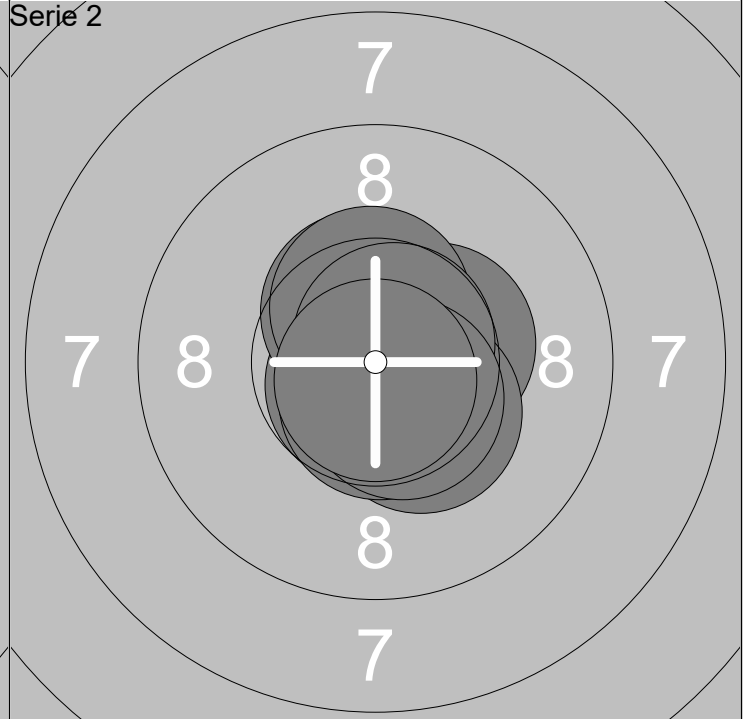
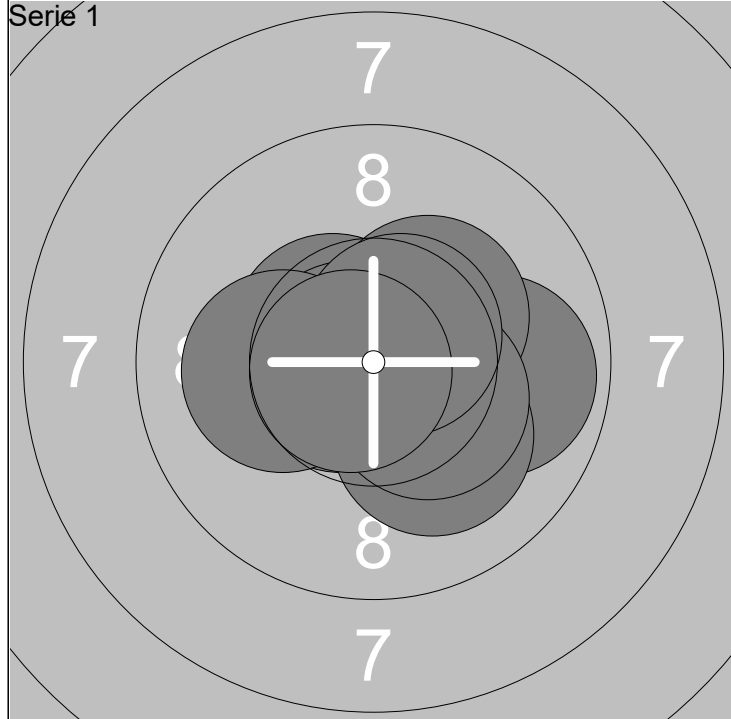

1: 10.5x ↖	6: 10.3x ↗	Serie	104.0
2: 10.7x ←	7: 10.1 ↓		
3: 10.7x ←	8: 10.4x ↘	Total	104.0
4: 10.1 ←	9: 10.6x ↗		
5: 9.9 →	10: 10.7x ←		

11: 10.7x ↓	16: 10.6x ↓	Serie	105.9
12: 10.4x →	17: 10.5x ↑		
13: 10.4x ↘	18: 10.7x ↗	Total	209.9
14: 10.5x ↑	19: 10.6x ↘		
15: 10.7x ↑	20: 10.8x ↓		

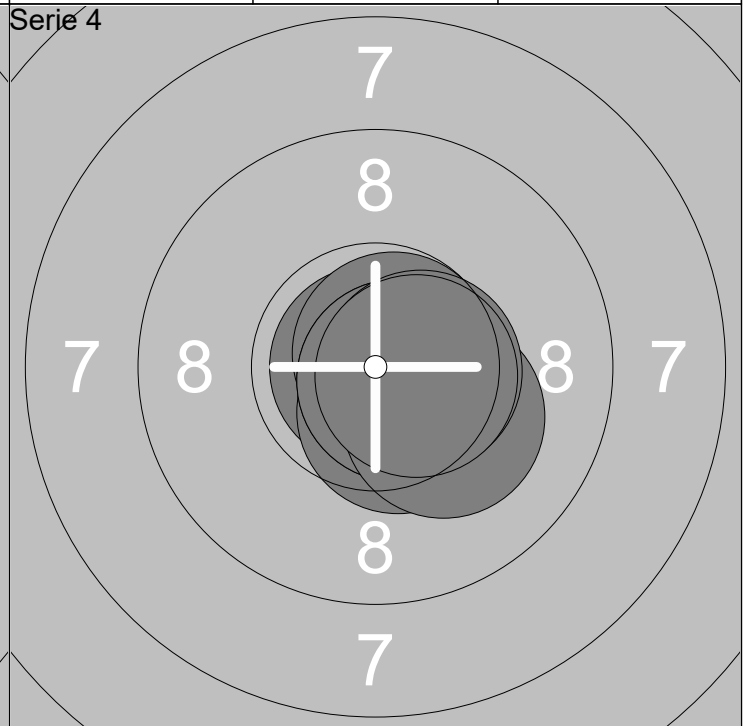
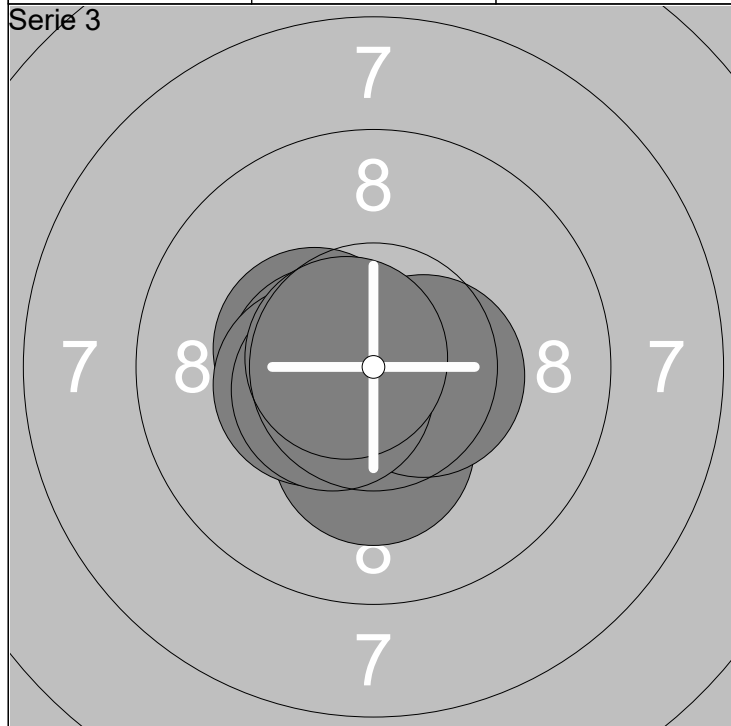

21: 10.7x ↓	26: 10.3x ↓	Serie	105.6
22: 10.4x ←	27: 10.5x →		
23: 10.6x ←	28: 10.4x ←	Total	315.5
24: 10.7x ↘	29: 10.5x ←		
25: 10.8x ↘	30: 10.7x ←		

31: 10.8x ↗	36: 10.7x ↘	Serie	106.2
32: 10.6x ↘	37: 10.7x ↘		
33: 10.9x ←	38: 10.2x ↘	Total	421.7
34: 10.7x ↗	39: 10.5x →		
35: 10.5x ↓	40: 10.6x →		

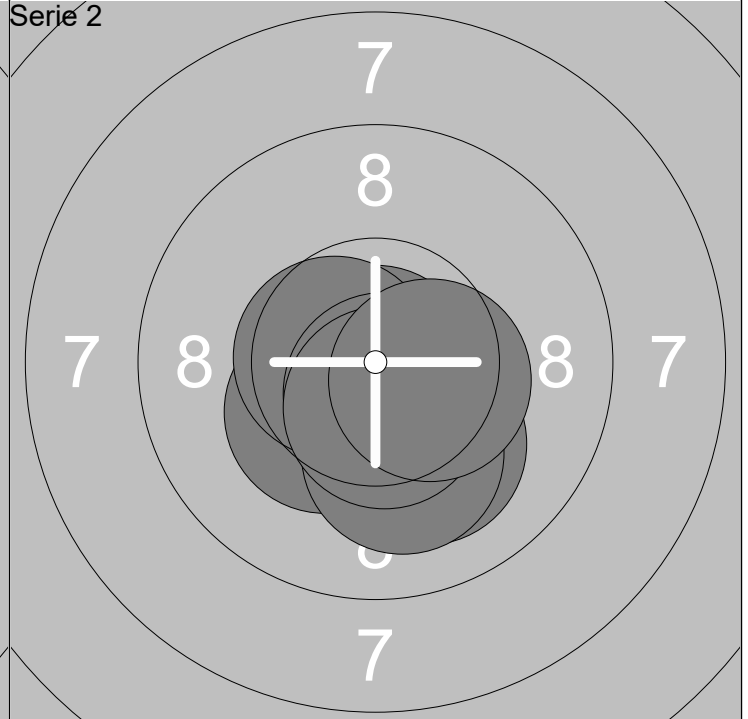
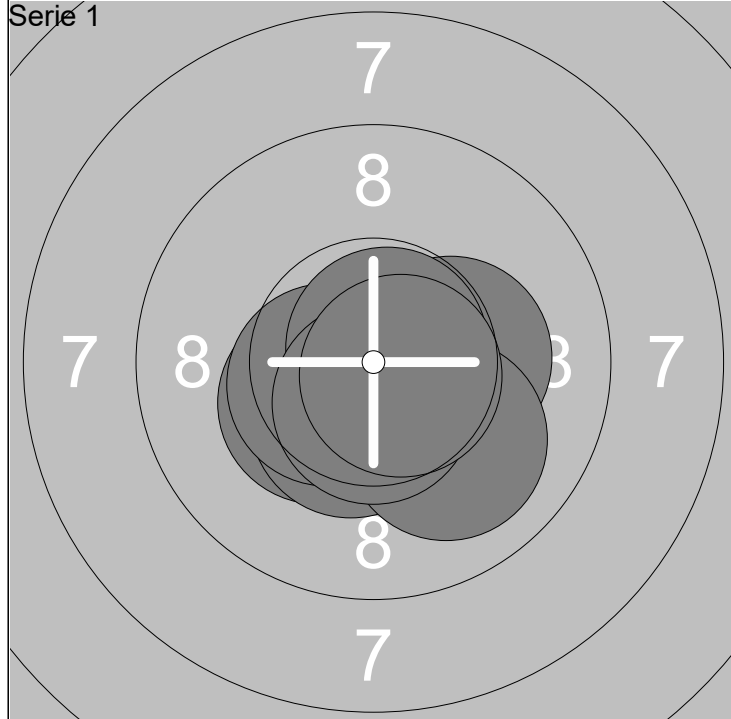

1: 10.4x ↙	6: 10.3x →	Serie	104.9
2: 10.4x ↓	7: 10.0 ↓		
3: 10.7x →	8: 10.8x ↗	Total	104.9
4: 10.5x ↙	9: 10.6x ↓		
5: 10.5x ↓	10: 10.7x ↘		

11: 10.3x ↙	16: 10.6x ↓	Serie	104.6
12: 10.9x ↓	17: 10.5x ↓		
13: 10.1 ↓	18: 10.1 ↓	Total	209.5
14: 10.6x ↓	19: 10.5x ↓		
15: 10.6x ←	20: 10.4x →		

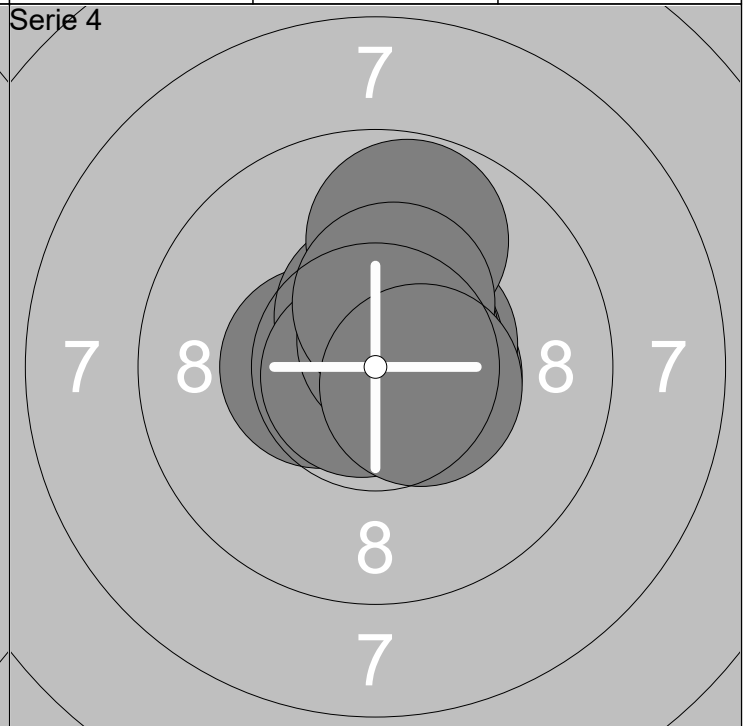
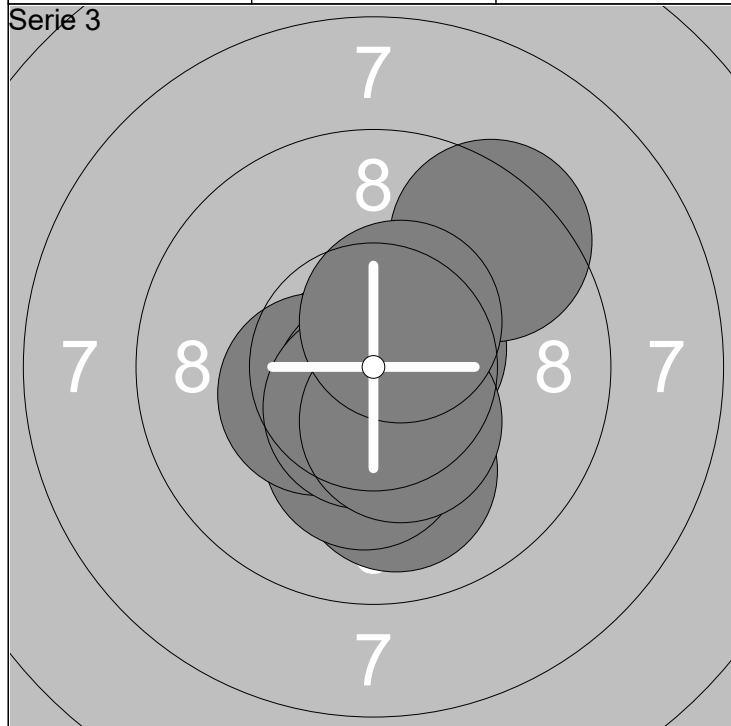

21: 10.0 ↓	26: 10.7x ↓	Serie	103.5
22: 10.2x ↓	27: 10.6x ↓		
23: 10.7x ↙	28: 10.4x ↓	Total	313.0
24: 10.4x ↙	29: 9.4 ↗		
25: 10.6x ↗	30: 10.5x ↗		

31: 10.4x ←	36: 9.8 ↑	Serie	104.6
32: 10.5x →	37: 10.8x ↙		
33: 10.5x ↗	38: 10.6x ↗	Total	417.6
34: 10.7x ↗	39: 10.3x ↑		
35: 10.5x ↑	40: 10.5x →		

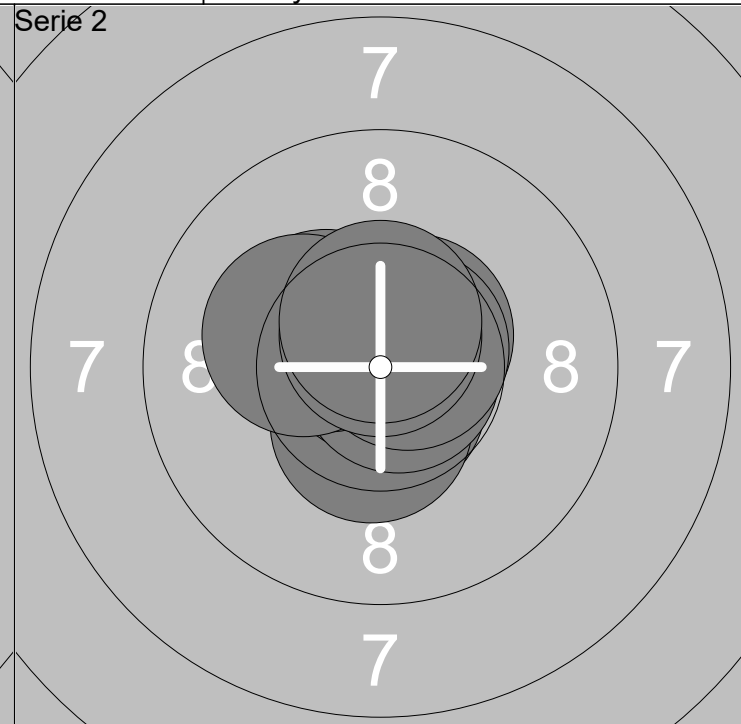
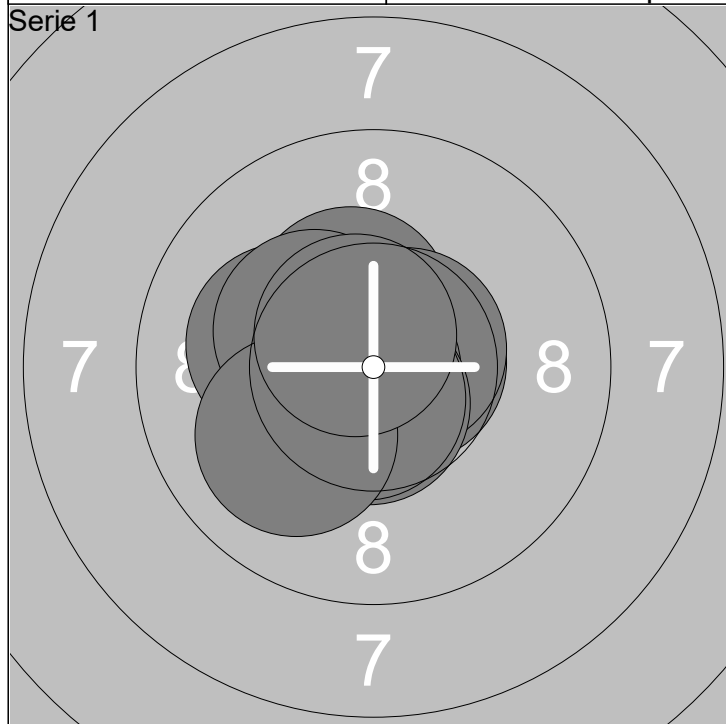

1: 10.2x ←	6: 10.8x ←	Serie	105.0
2: 10.7x →	7: 10.6x ↓		
3: 10.4x ↗	8: 10.7x ↓	Total	105.0
4: 10.6x ↗	9: 10.1 ↙		
5: 10.3x ↖	10: 10.6x ↖		

11: 10.7x ↓	16: 10.7x ↗	Serie	106.0
12: 10.5x ↓	17: 10.4x ↖		
13: 10.8x ↗	18: 10.2x ↖	Total	211.0
14: 10.6x ↗	19: 10.7x ↗		
15: 10.8x →	20: 10.6x ↗		

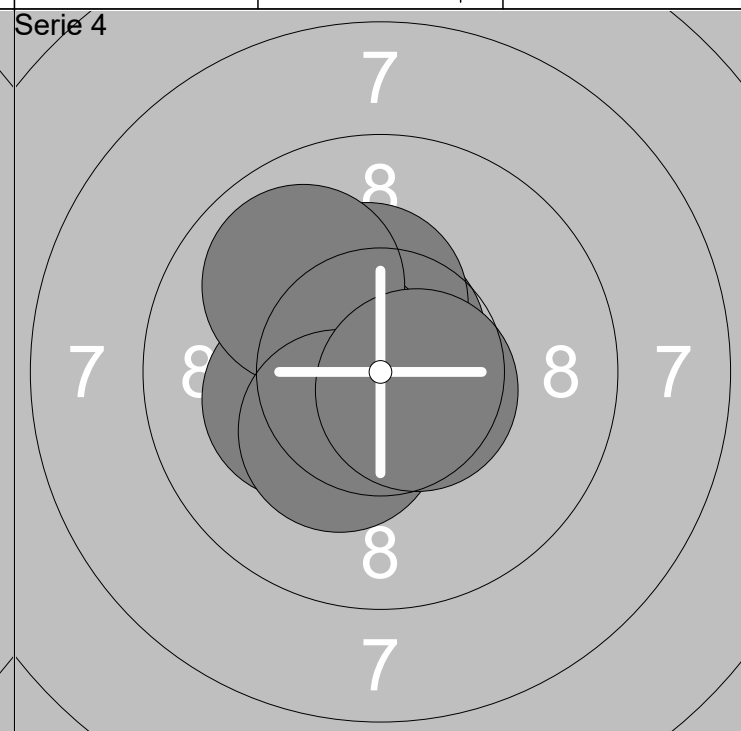
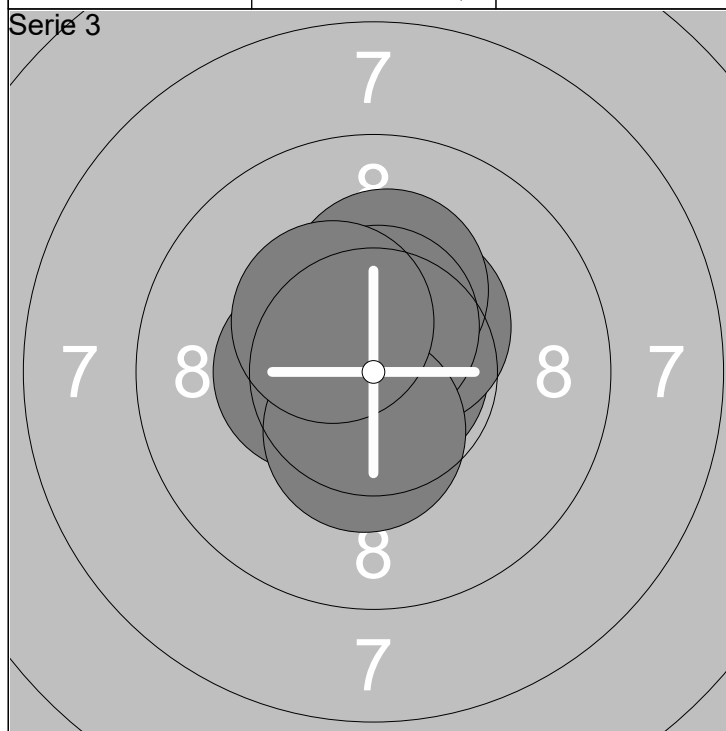

21: 10.8x ↖	26: 10.2x ↗	Serie	105.3
22: 10.7x ↗	27: 10.4x ↖		
23: 10.6x ↗	28: 10.6x ↗	Total	316.3
24: 10.8x →	29: 10.4x ↓		
25: 10.4x ↗	30: 10.4x ↖		

31: 10.8x ↖	36: 10.2x ↖	Serie	104.6
32: 10.7x ↙	37: 10.6x ↙		
33: 10.6x ↗	38: 9.9 ↖	Total	420.9
34: 10.3x ↗	39: 10.3x ↙		
35: 10.6x ↖	40: 10.6x ↗		



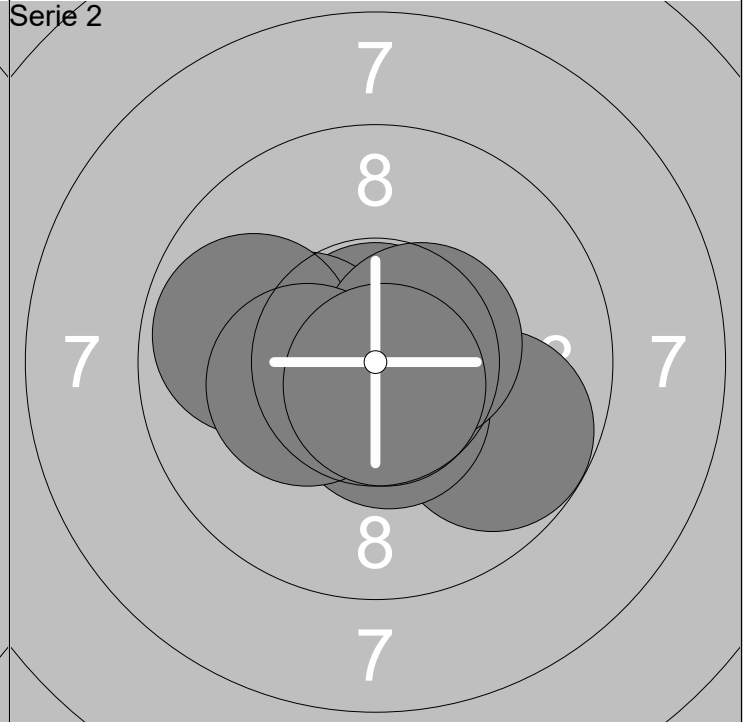
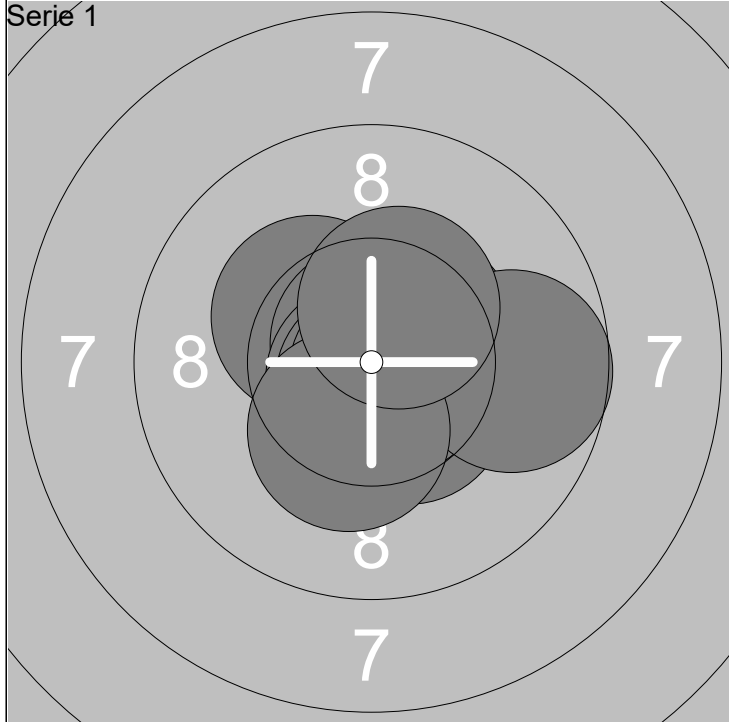

1: 10.5x ↗	6: 10.7x ↓	Serie	104.7
2: 10.3x ↖	7: 10.7x ↓		
3: 10.8x ↑	8: 9.7 →	Total	104.7
4: 10.8x ↓	9: 10.3x ↓		
5: 10.5x ↘	10: 10.4x ↗		

11: 10.5x ↓	16: 9.7 ↘	Serie	103.7
12: 10.6x →	17: 10.5x ↓		
13: 10.8x ↑	18: 10.5x →	Total	208.4
14: 10.3x ←	19: 10.3x ←		
15: 9.8 ←	20: 10.7x ↓		

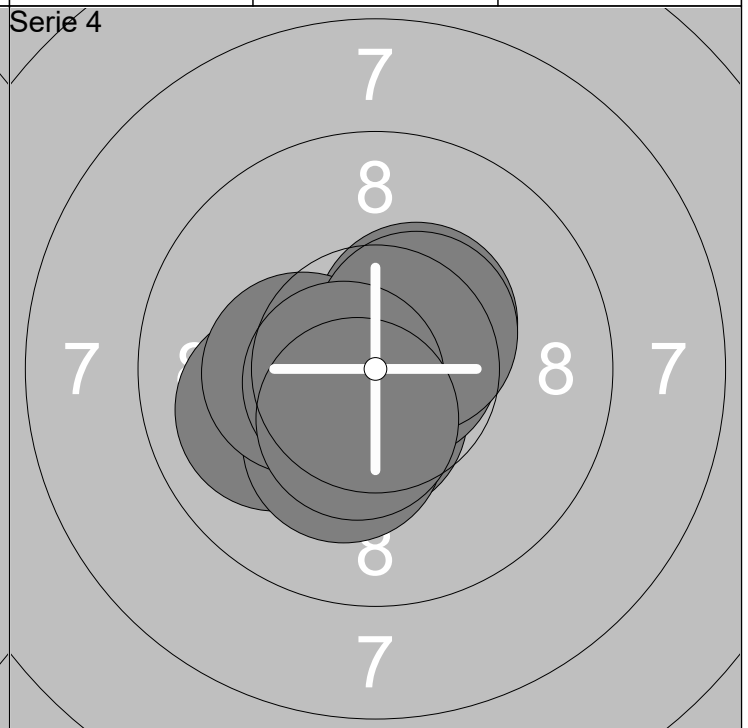
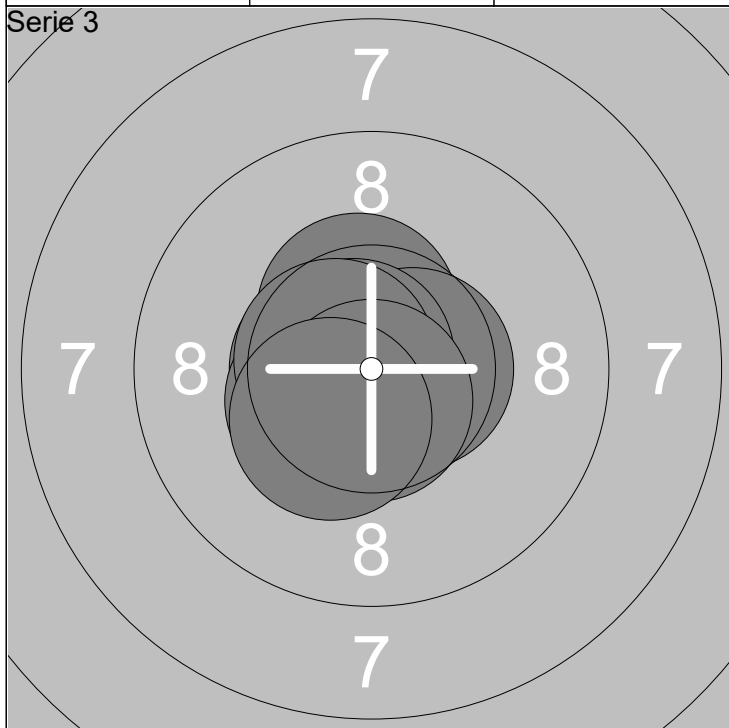

21: 10.6x ←	26: 10.8x ↖	Serie	105.9
22: 10.7x ↑	27: 10.5x ↙		
23: 10.5x ↑	28: 10.6x ←	Total	314.3
24: 10.6x →	29: 10.7x ↓		
25: 10.5x ↙	30: 10.4x ↘		

31: 10.5x ↓	36: 10.6x ↙	Serie	104.3
32: 10.7x →	37: 10.3x ←		
33: 10.4x ↗	38: 10.5x ↗	Total	418.6
34: 10.0 ←	39: 10.6x ←		
35: 10.2x ↓	40: 10.5x ↓		

Skjutlag

Tavla

3

12

Anni Salomonsson

Rottne Industri Cup 2019

Berga Ungdomsskytteförening

Ösm

26.10.2019

Rottne Industri Cup 2019

Söraby SKF

Serie 1

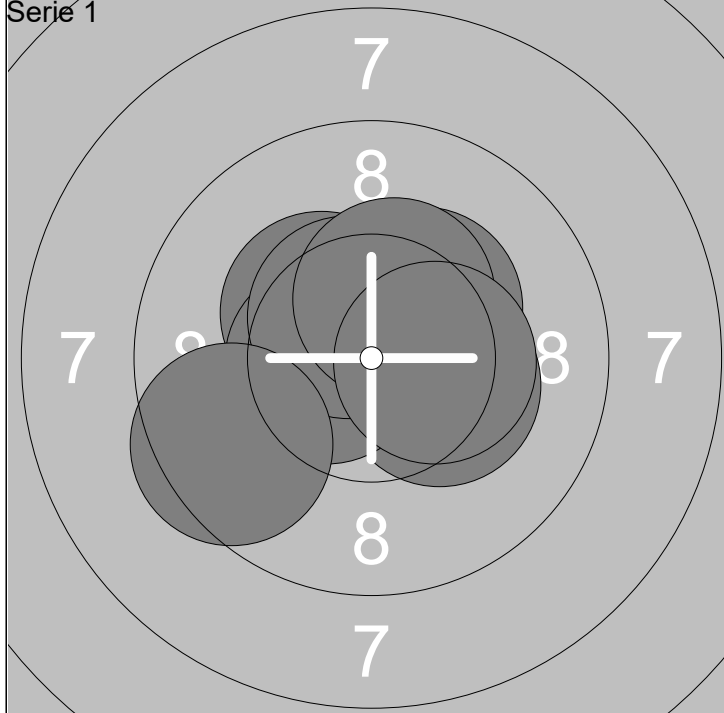

Serie 2

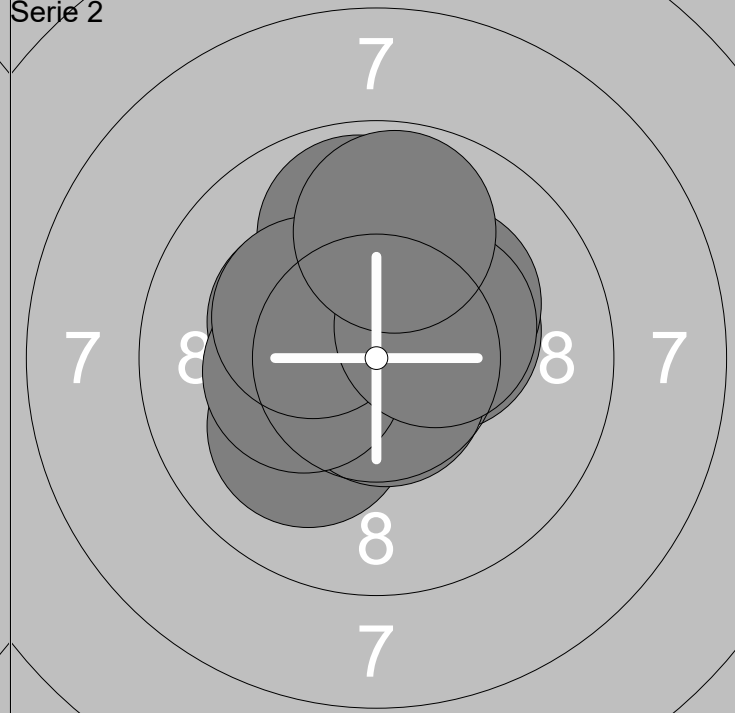

1: 10.3x →	6: 10.3x ↗
2: 10.3x ↖	7: 10.5x ↘
3: 10.6x ↑	8: 9.5 ←
4: 10.7x ↗	9: 10.4x ↑
5: 10.6x ←	10: 10.4x →

Serie	103.6
Total	103.6

11: 10.1 ↙	16: 10.3x ←
12: 10.3x ↖	17: 10.2x ↗
13: 9.9 ↑	18: 10.3x ↘
14: 10.4x ↗	19: 10.4x ↗
15: 10.7x ↓	20: 9.8 ↑

Serie	102.4
Total	206.0

Serie 3

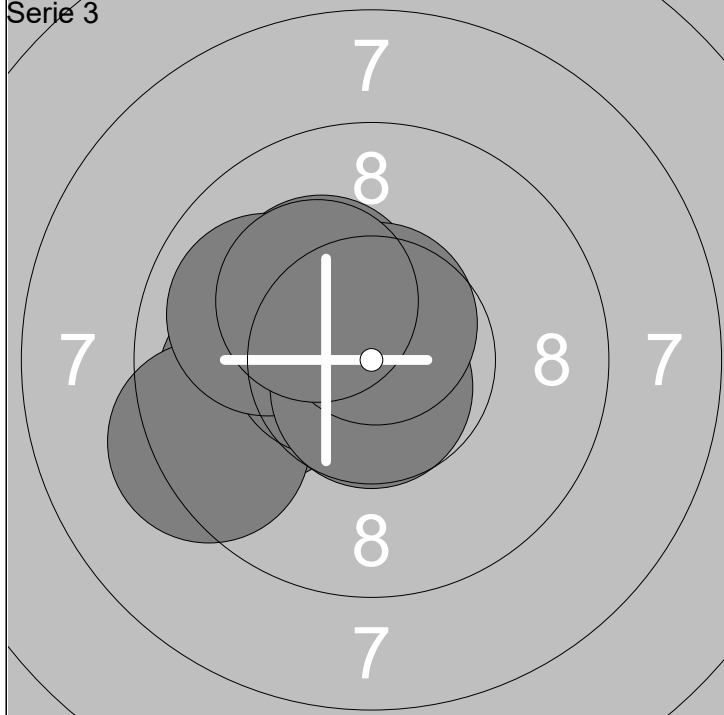

Serie 4

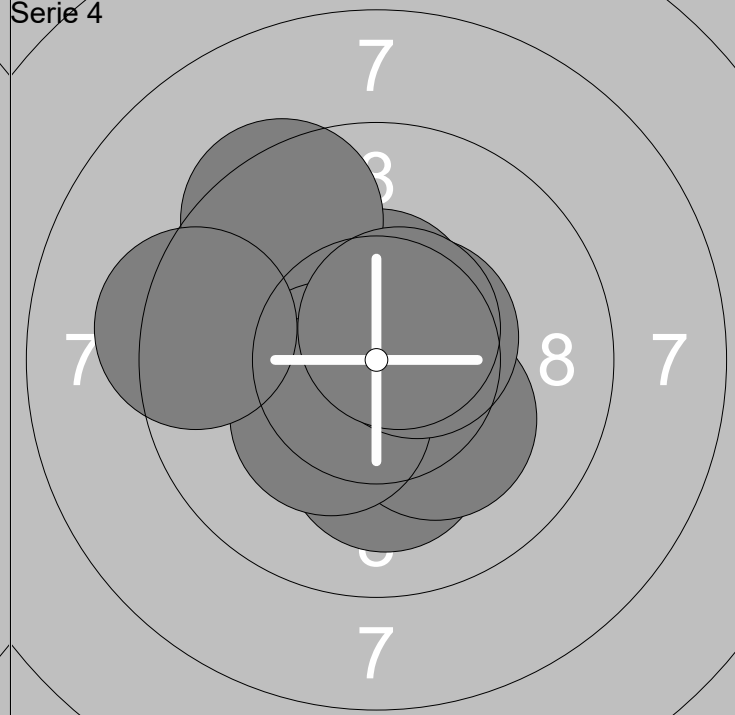

21: 9.9 ←	26: 10.7x ↖
22: 10.4x ←	27: 9.9 ←
23: 9.3 ←	28: 10.7x ↓
24: 10.6x ←	29: 10.6x ↑
25: 10.2x ↖	30: 10.3x ↖

Serie	102.6
Total	308.6

31: 10.1 ↓	36: 10.5x ←
32: 9.9 ↖	37: 10.3x ↘
33: 10.2x ↘	38: 9.3 ←
34: 10.5x ↑	39: 10.5x ↗
35: 9.4 ↖	40: 10.6x ↗

Serie	101.3
Total	409.9

Rottne Industri Cup 2019

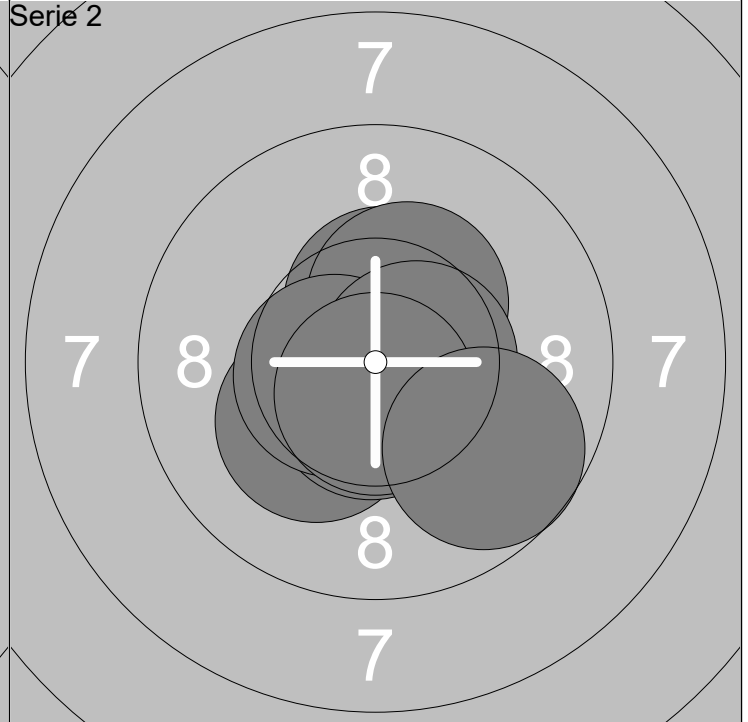
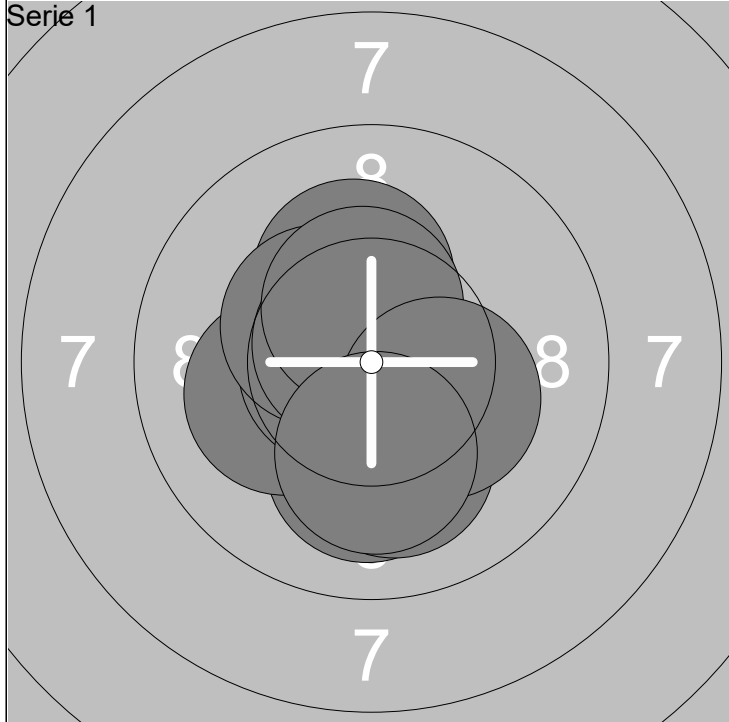

1: 10.2x ↑	6: 10.7x ↖	Serie	103.3
2: 10.1 ↓	7: 10.5x ↑		
3: 10.2x ←	8: 10.1 ↓	Total	103.3
4: 10.7x ←	9: 10.3x →		
5: 10.4x ↖	10: 10.1 ↓		

11: 10.2x ↙	16: 10.6x ↓	Serie	104.6
12: 10.6x ↘	17: 10.6x ←		
13: 10.4x ↑	18: 10.6x →	Total	207.9
14: 10.8x ↙	19: 10.7x ↓		
15: 10.4x ↑	20: 9.7 ↘		

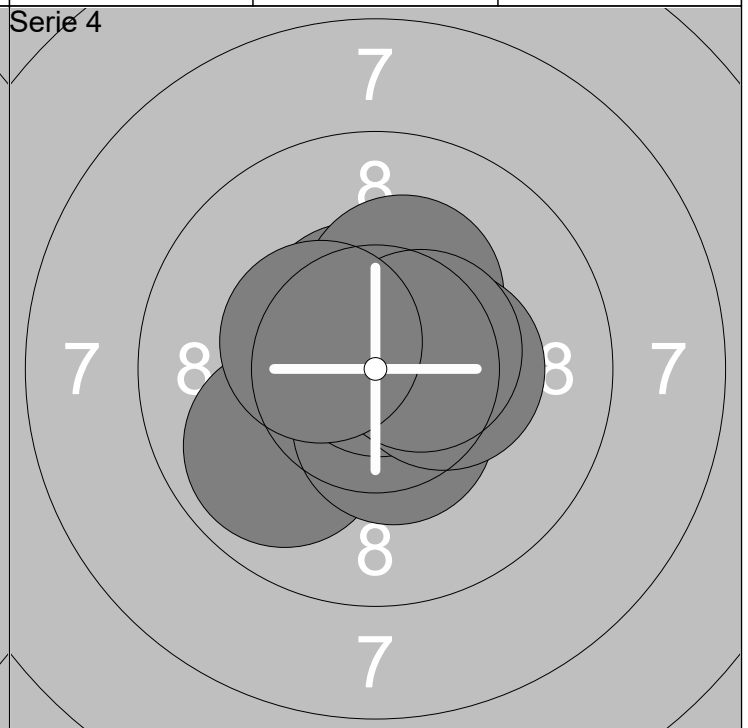
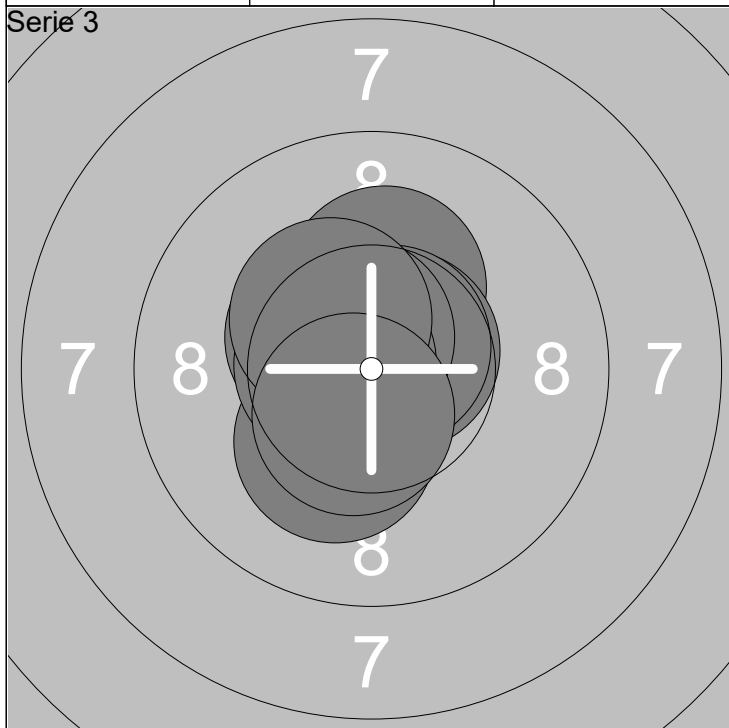

21: 10.2x ↑	26: 10.6x ↖	Serie	105.3
22: 10.7x ↗	27: 10.5x ↖		
23: 10.9x ↙	28: 10.6x ←	Total	313.2
24: 10.2x ↓	29: 10.4x ↖		
25: 10.7x ↗	30: 10.5x ↓		

31: 10.5x ↑	36: 10.8x ↑	Serie	104.0
32: 10.5x ↑	37: 10.3x ↑		
33: 10.3x ↙	38: 10.4x →	Total	417.2
34: 9.9 ←	39: 10.5x ↗		
35: 10.4x ↓	40: 10.4x ↖		

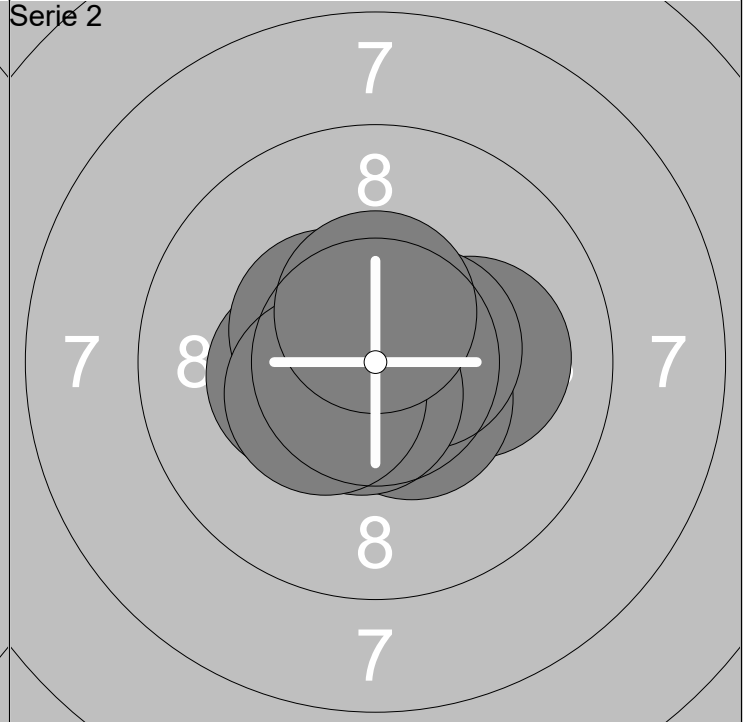
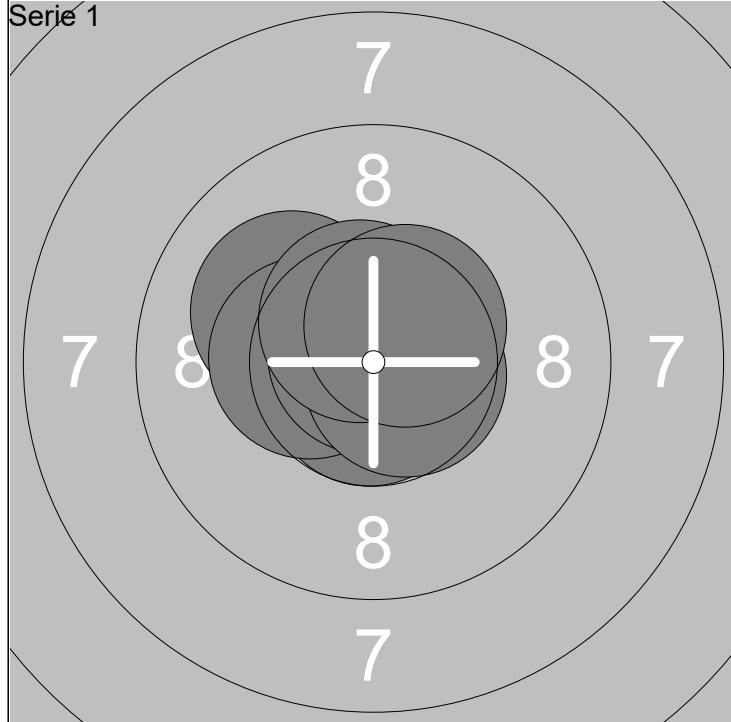

1: 10.7x ↑	6: 10.4x ←	Serie	106.0
2: 10.1 ↖	7: 10.9x ↗		
3: 10.7x ↓	8: 10.6x →	Total	106.0
4: 10.7x ↗	9: 10.6x ↗		
5: 10.8x ↖	10: 10.5x ↗		

11: 10.7x ←	16: 10.5x ↖	Serie	104.9
12: 10.1 →	17: 10.5x →		
13: 10.8x ↓	18: 10.6x ↓	Total	210.9
14: 10.5x ↘	19: 10.4x ←		
15: 10.3x ←	20: 10.5x ↑		

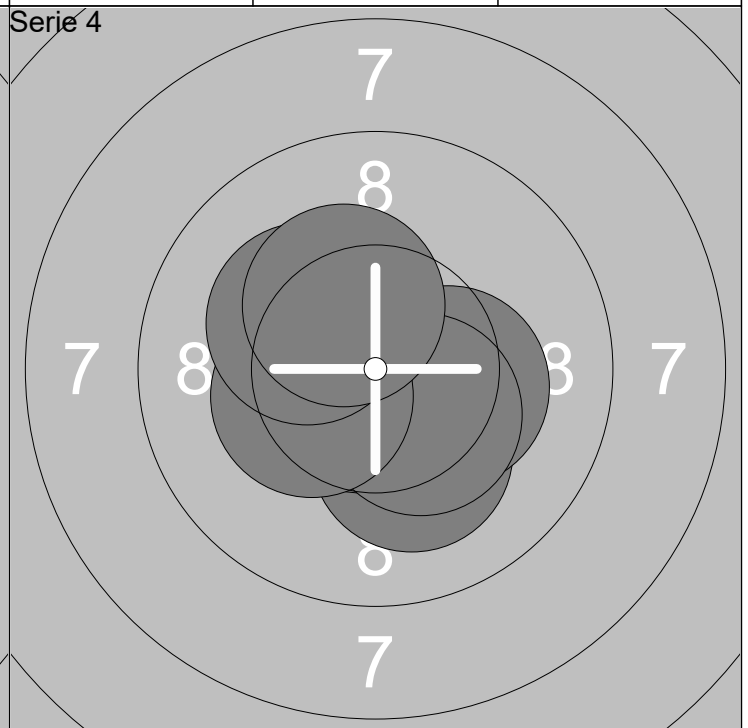
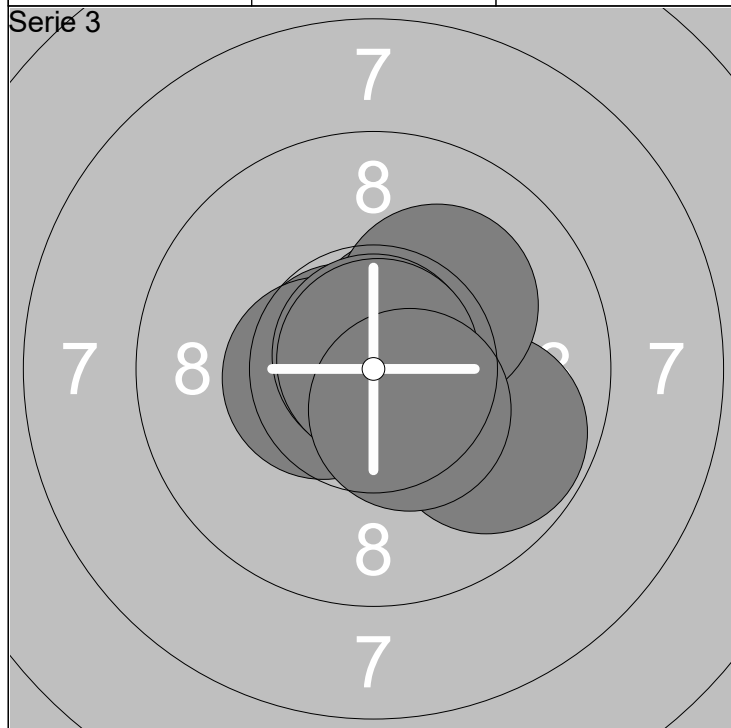

21: 10.7x ←	26: 10.1 ↗	Serie	105.1
22: 9.8 →	27: 10.5x ←		
23: 10.6x ↗	28: 10.8x ↑	Total	316.0
24: 10.6x →	29: 10.9x ↗		
25: 10.6x ↗	30: 10.5x ↘		

31: 10.1 ↓	36: 10.3x →	Serie	103.9
32: 10.8x ↗	37: 10.4x ↓		
33: 10.7x ↓	38: 10.3x ←	Total	419.9
34: 10.4x ↗	39: 10.2x ↗		
35: 10.4x ↗	40: 10.3x ↗		

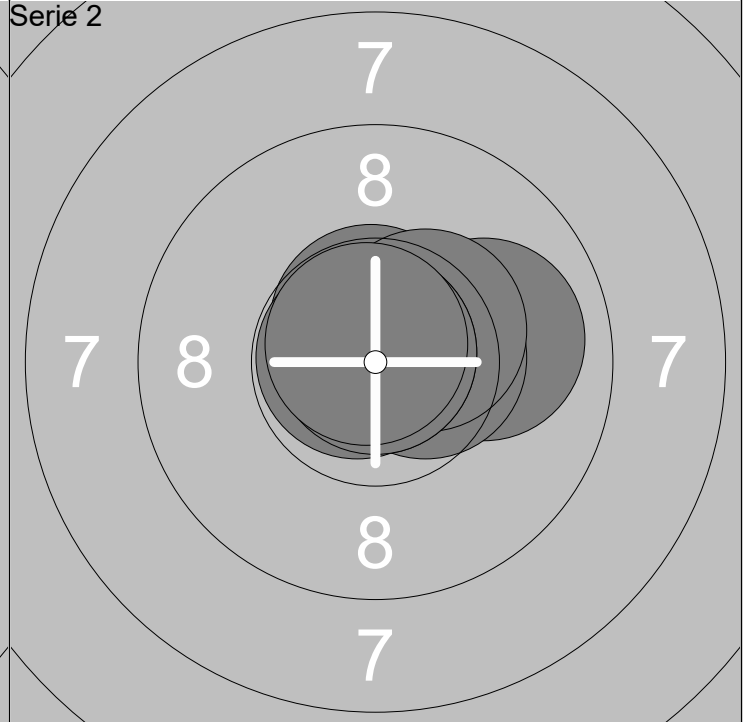
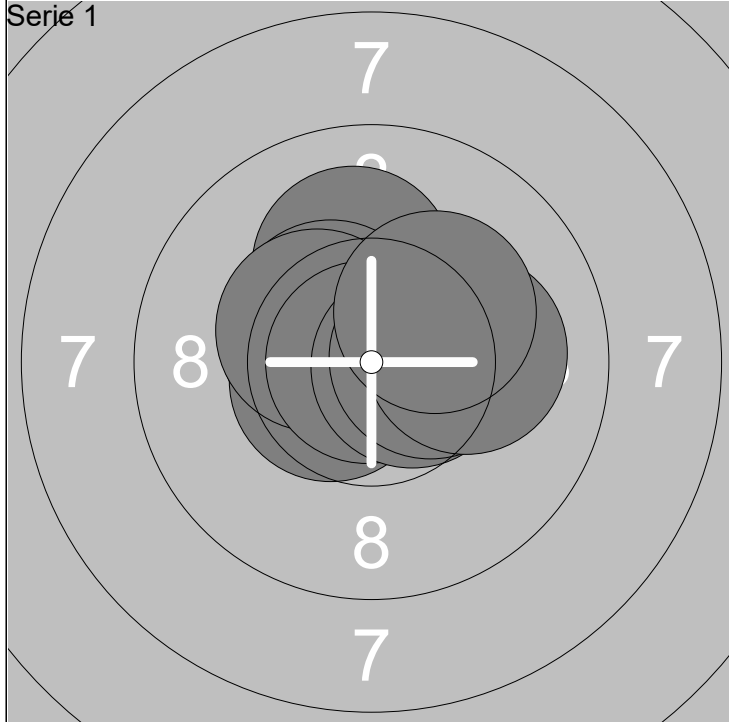

1: 10.1 ↑	6: 10.9x ←	Serie	104.2
2: 10.5x ↙	7: 10.6x →		
3: 10.4x ↗	8: 10.4x →	Total	104.2
4: 10.5x ↙	9: 10.1 →		
5: 10.4x ↙	10: 10.3x ↗		

11: 10.5x ↗	16: 10.4x ↗	Serie	106.2
12: 10.0 →	17: 10.9x ↑		
13: 10.5x →	18: 10.8x ←	Total	210.4
14: 10.8x ↑	19: 10.9x ↑		
15: 10.6x ↑	20: 10.8x ↘		

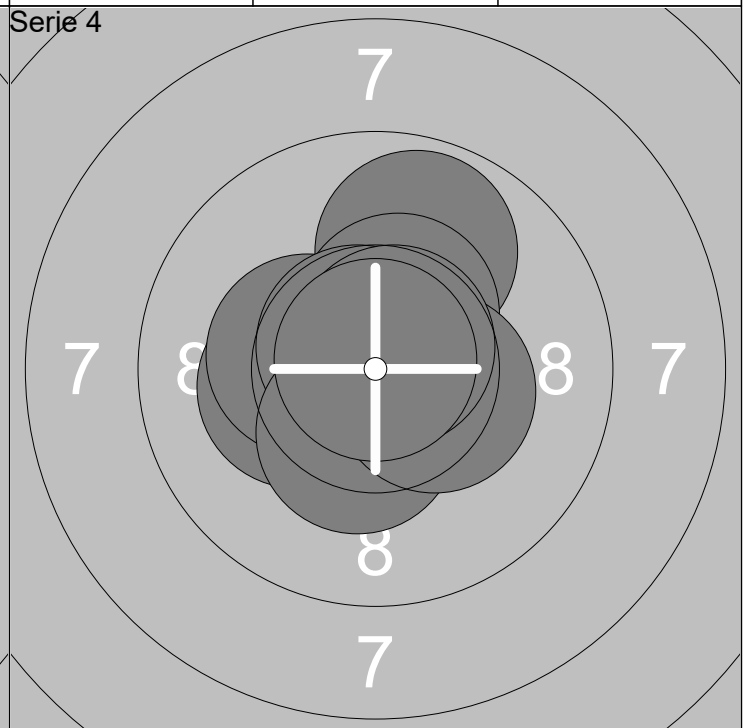
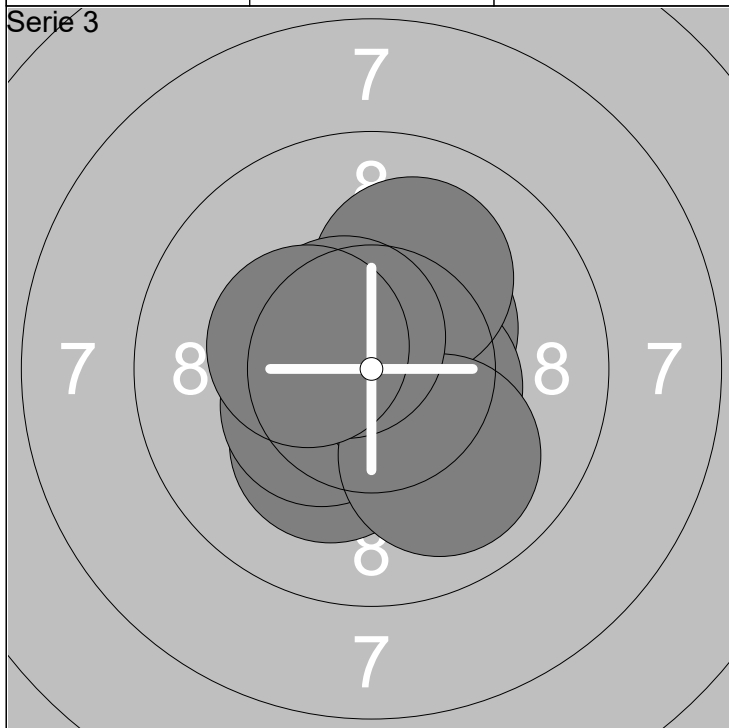

21: 10.6x ↑	26: 10.5x →	Serie	103.9
22: 10.2x ↘	27: 10.1 ↑		
23: 10.4x ↗	28: 10.0 ↘	Total	314.3
24: 10.8x ↘	29: 10.6x ↗		
25: 10.4x ↙	30: 10.3x ←		

31: 10.3x ←	36: 10.7x ↘	Serie	104.7
32: 10.3x ←	37: 10.4x ↘		
33: 10.7x ↑	38: 10.4x →	Total	419.0
34: 9.9 ↑	39: 10.7x ↗		
35: 10.4x ↗	40: 10.9x ↑		

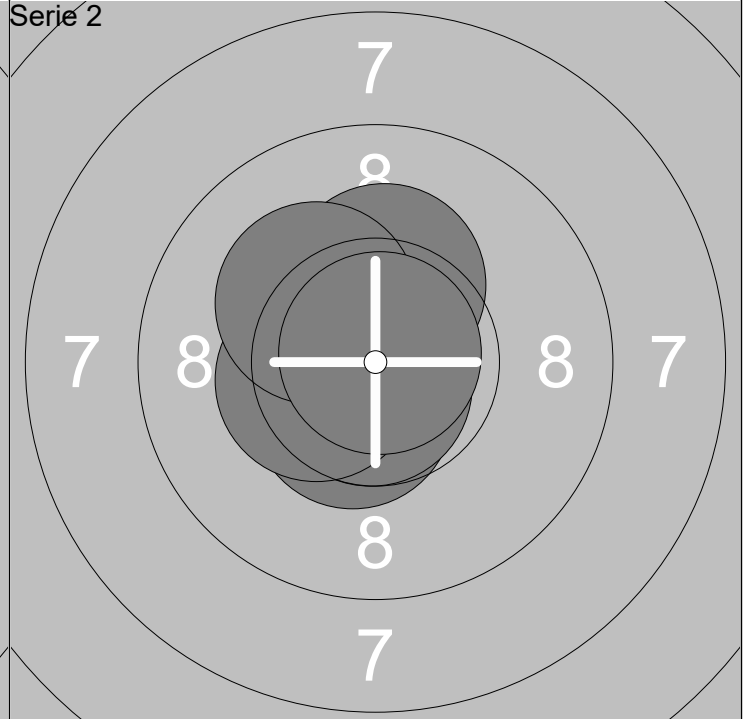
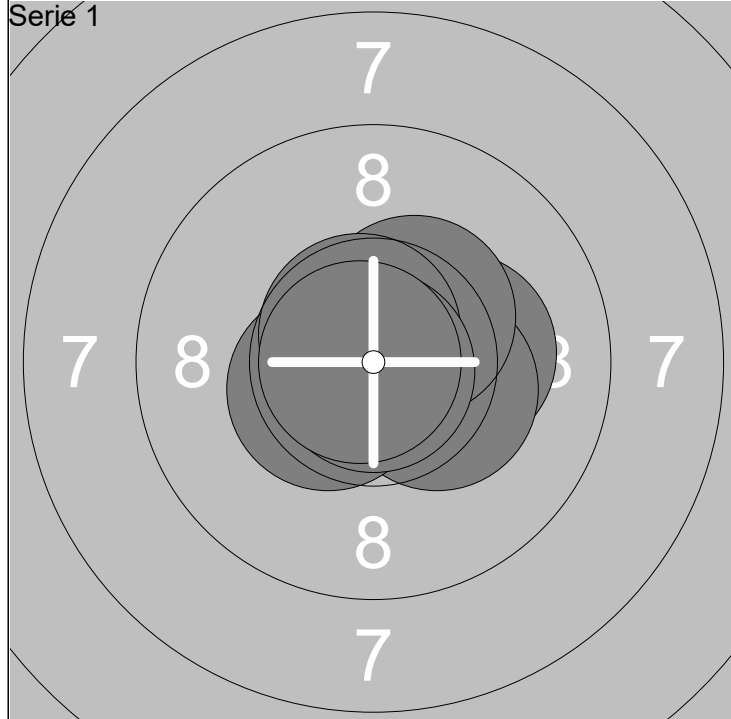

1: 10.2x →	6: 10.5x ↙	Serie	106.0
2: 10.7x →	7: 10.4x ↗		
3: 10.8x ↑	8: 10.7x ↗	Total	106.0
4: 10.7x ↗	9: 10.9x ↓		
5: 10.3x →	10: 10.8x ←		

11: 10.8x ↓	16: 10.7x ↗	Serie	105.9
12: 10.7x ←	17: 10.3x ↑		
13: 10.5x ↓	18: 10.4x ←	Total	211.9
14: 10.7x ↖	19: 10.2x ↖		
15: 10.8x ↓	20: 10.8x ↗		

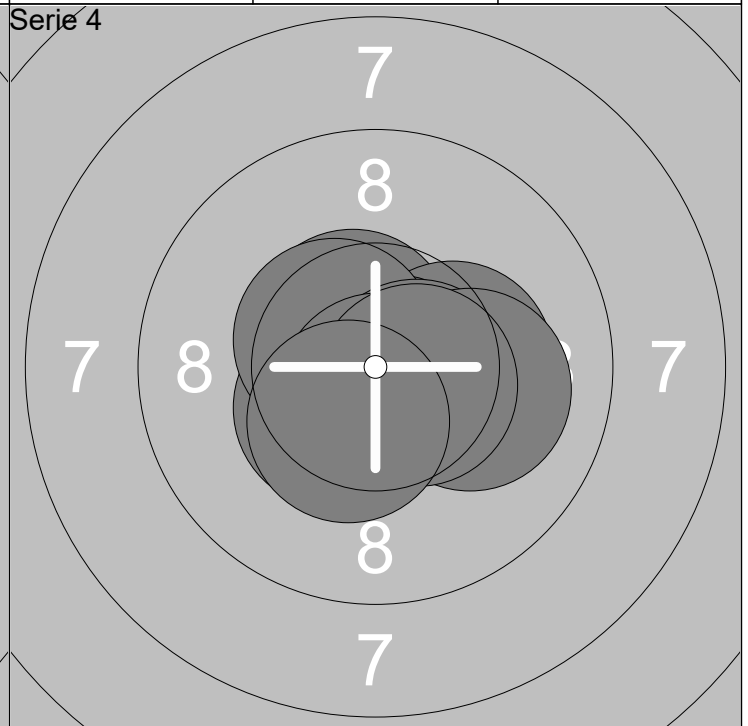
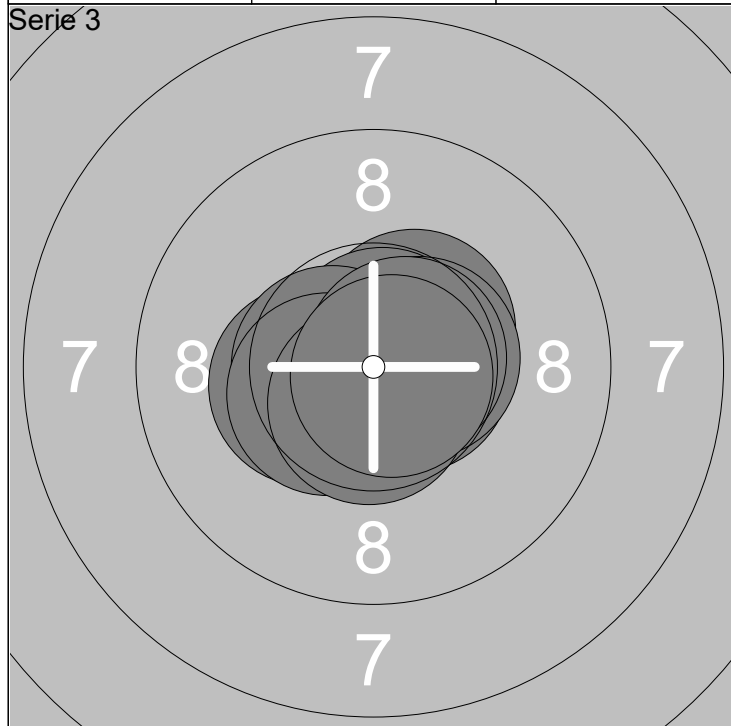

21: 10.6x →	26: 10.5x →	Serie	105.8
22: 10.5x ↗	27: 10.5x ↙		
23: 10.7x ↑	28: 10.6x →	Total	317.7
24: 10.4x ←	29: 10.6x ↓		
25: 10.6x ←	30: 10.8x →		

31: 10.6x ↖	36: 10.6x →	Serie	105.1
32: 10.3x →	37: 10.7x ↓		
33: 10.8x →	38: 10.1 →	Total	422.8
34: 10.5x ↙	39: 10.6x →		
35: 10.5x ↖	40: 10.4x ↓		

Serie 1

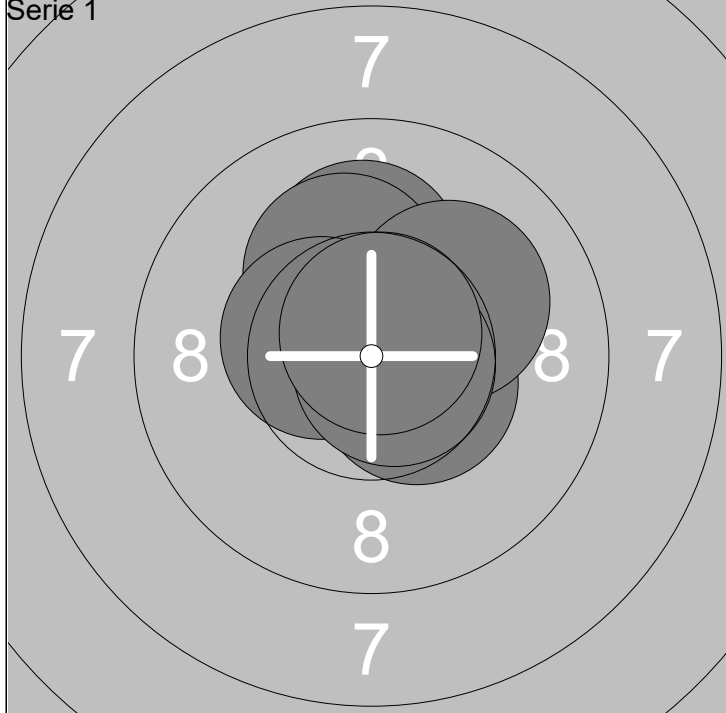

Serie 2

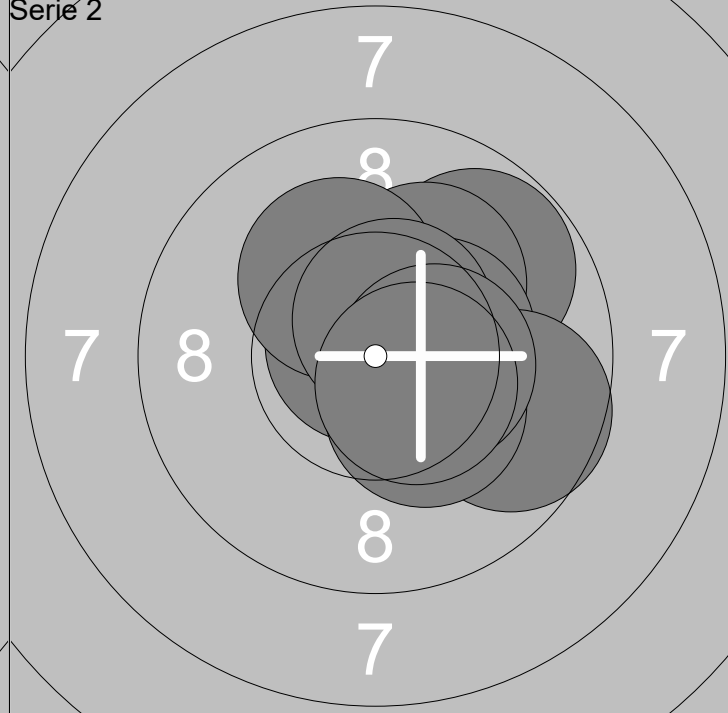

1: 10.6x ↗	6: 10.5x ↘	Serie	104.2	11: 9.8 ↗	16: 10.6x ↗	Serie	102.8
2: 10.4x ↗	7: 10.5x ↙		Total	104.2	12: 10.2x ↗		17: 9.6 ↘
3: 10.1 ↑	8: 10.1 ↗				13: 10.8x ↗	18: 10.3x ↘	
4: 10.4x ↗	9: 10.7x ↘			14: 10.2x ↗	19: 10.4x ↘		
5: 10.2x ↗	10: 10.7x ↗			15: 10.4x →	20: 10.5x ↘		

Serie 3

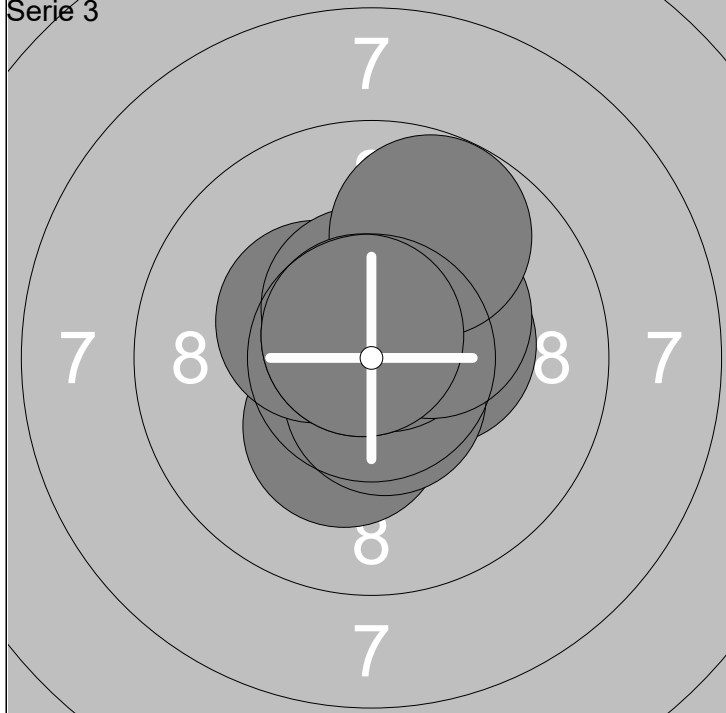

Serie 4

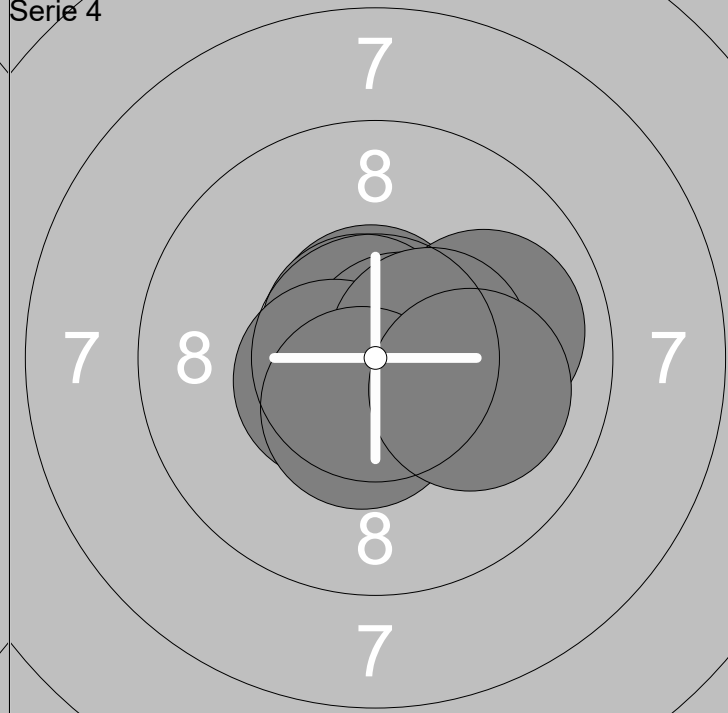

21: 10.3x ↓	26: 10.7x ↗	Serie	104.4	31: 10.6x →	36: 10.5x ↙	Serie	104.8
22: 10.4x →	27: 10.3x ↗		Total	311.4	32: 10.7x ↑		37: 10.5x →
23: 10.6x ↓	28: 10.5x ↑				33: 10.0 →	38: 10.5x →	
24: 10.4x ↙	29: 9.8 ↗			34: 10.7x ↗	39: 10.5x ↓		
25: 10.7x ↗	30: 10.7x ↗			35: 10.7x →	40: 10.1 →		

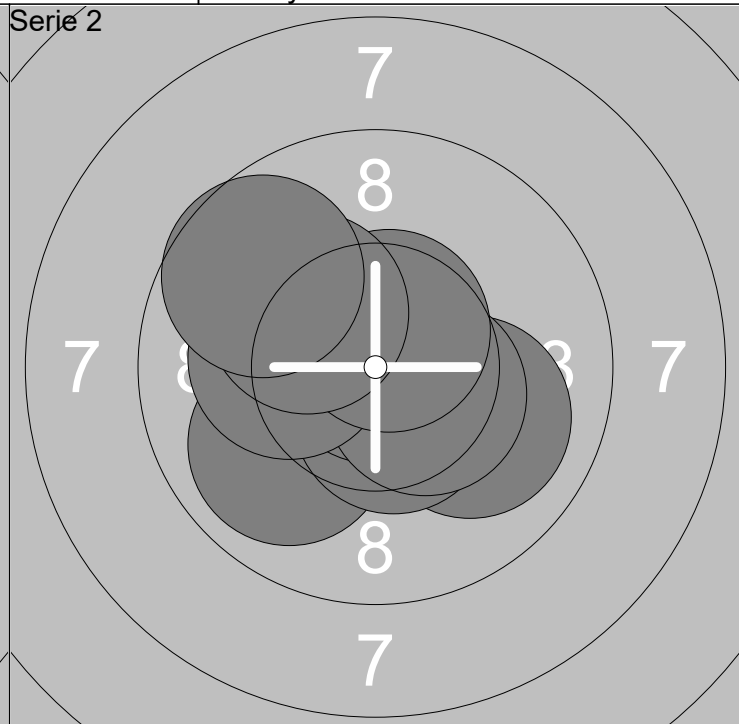
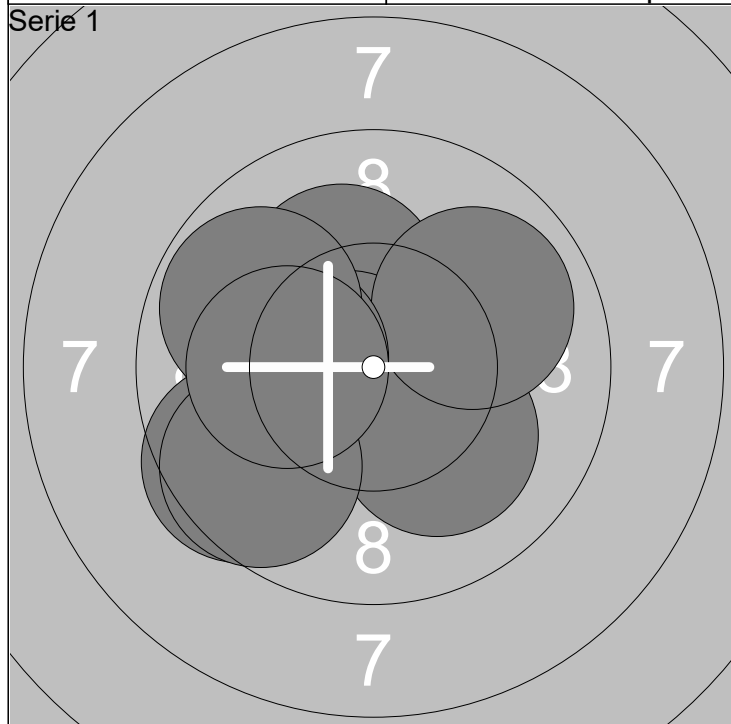

1: 10.3x ←	6: 9.6 ↙	Serie	100.5
2: 10.2x ↗	7: 9.9 ↘		
3: 10.7x ←	8: 10.2x ←	Total	100.5
4: 9.5 ↙	9: 9.8 ↖		
5: 10.1 ↘	10: 10.2x ←		

11: 10.0 →	16: 10.5x →	Serie	102.7
12: 10.0 ↙	17: 10.2x ←		
13: 10.5x ↓	18: 10.6x ↗	Total	203.2
14: 10.9x ↗	19: 10.2x ↖		
15: 10.1 ↖	20: 9.7 ↖		

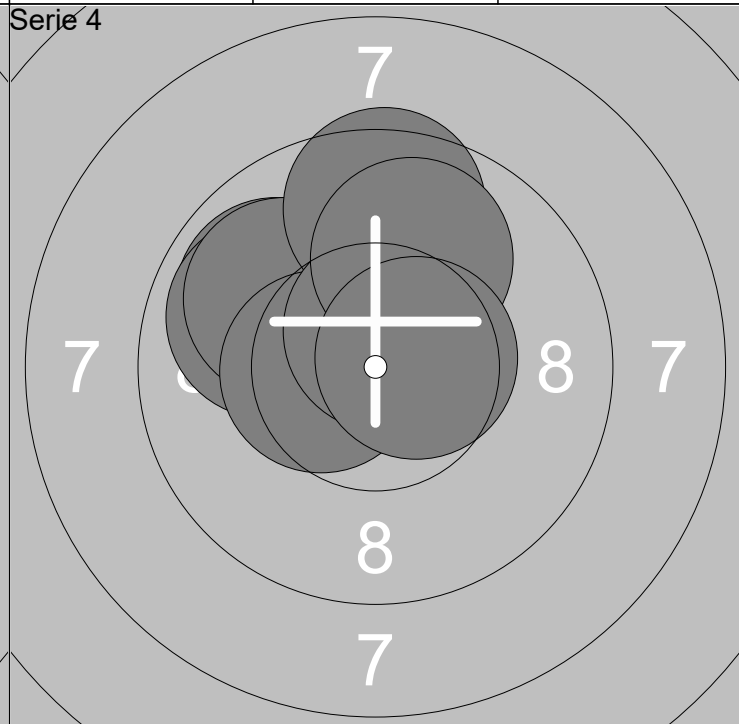
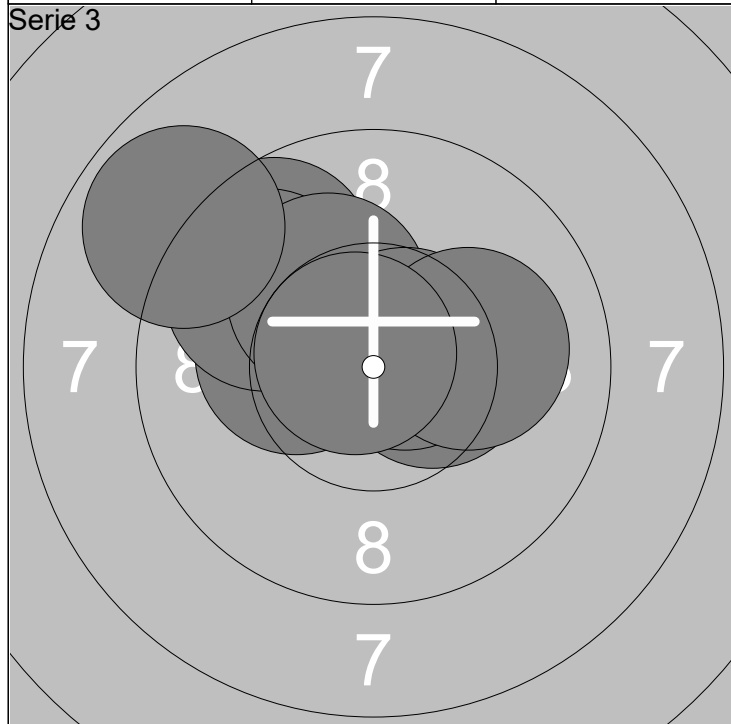

21: 10.4x →	26: 10.2x ↗	Serie	100.8
22: 9.7 ↗	27: 10.6x ↘		
23: 10.2x ↖	28: 10.1 →	Total	304.0
24: 10.3x ←	29: 8.9 ↗		
25: 9.7 ↗	30: 10.7x ↗		

31: 10.2x ↗	36: 9.5 ↗	Serie	101.6
32: 9.9 ↖	37: 10.5x ←		
33: 9.9 ↖	38: 10.6x ↗	Total	405.6
34: 10.0 ↖	39: 9.9 ↗		
35: 10.5x ↗	40: 10.6x →		



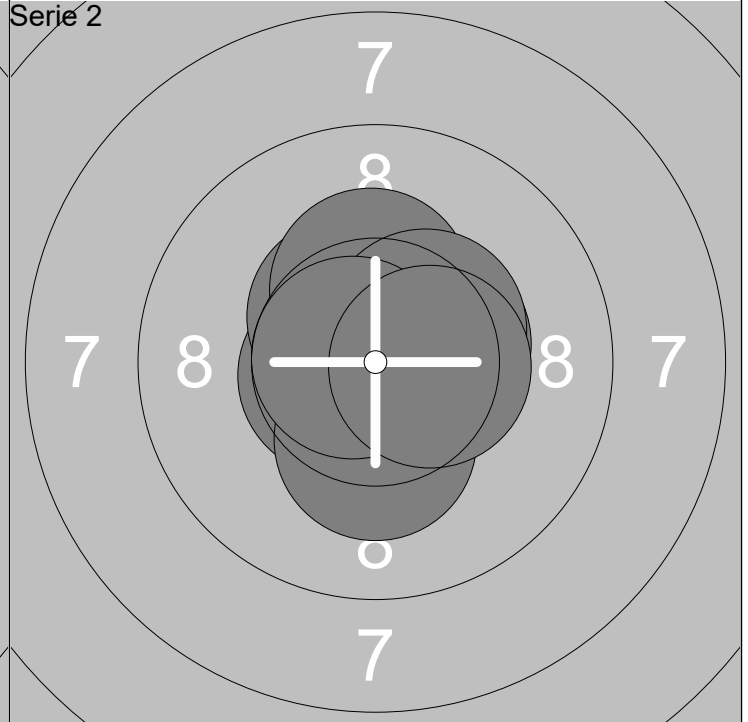
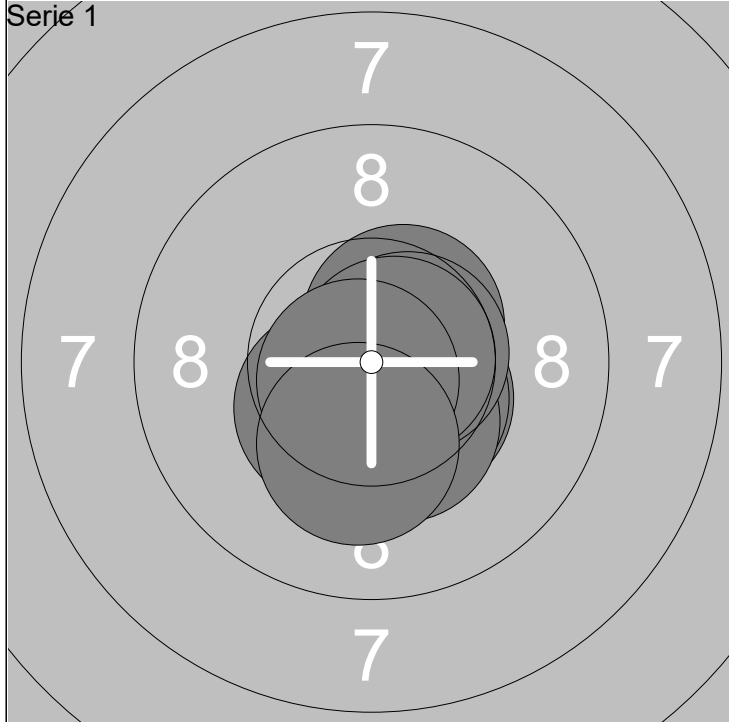

1: 10.5x ↘	6: 10.6x →	Serie	105.1
2: 10.5x ↗	7: 10.7x →		
3: 10.6x ↙	8: 10.4x ↙	Total	105.1
4: 10.5x ↘	9: 10.7x ↙		
5: 10.4x ↘	10: 10.2x ↘		

11: 10.6x ↓	16: 10.5x →	Serie	104.8
12: 10.6x ←	17: 10.4x →		
13: 10.3x ↓	18: 10.4x ↗	Total	209.9
14: 10.5x ↖	19: 10.7x ←		
15: 10.3x ↑	20: 10.5x →		

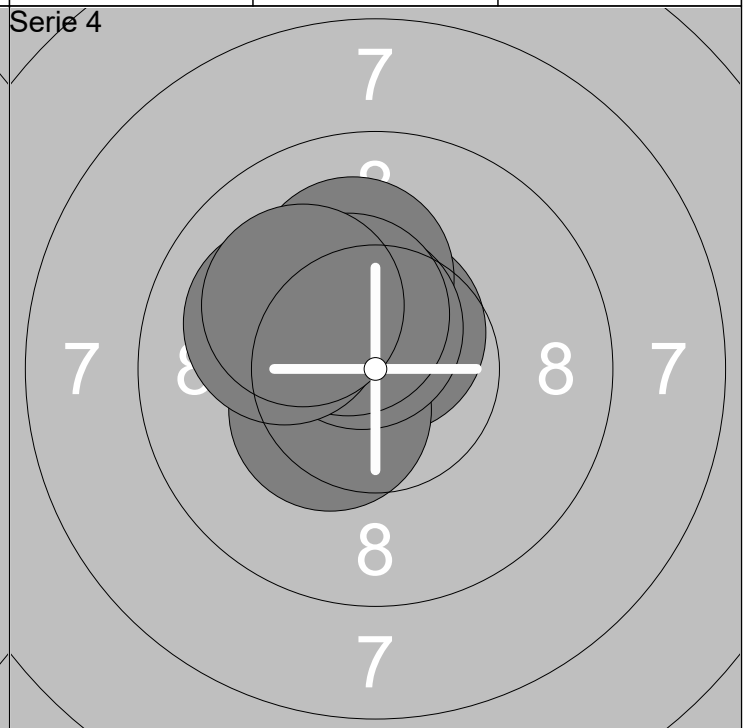
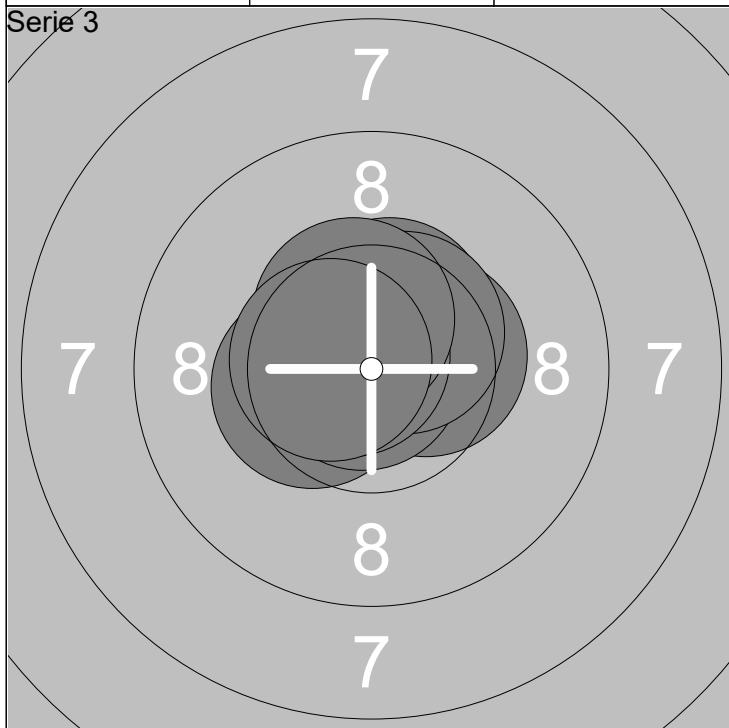

21: 10.4x →	26: 10.6x ↑	Serie	105.8
22: 10.7x ↖	27: 10.5x ↗		
23: 10.5x ↑	28: 10.7x ↖	Total	315.7
24: 10.4x ←	29: 10.5x ↑		
25: 10.9x ←	30: 10.6x ←		

31: 10.6x ↑	36: 10.4x ↙	Serie	103.5
32: 10.3x ↖	37: 10.6x ↑		
33: 10.6x ←	38: 10.4x ↗	Total	419.2
34: 10.4x ↖	39: 10.0 ↖		
35: 10.1 ↑	40: 10.1 ↗		

Skjutlag

3

Tavla

21

Sophia Svensson

Rottne Industri Cup 2019

Älmhults Skytteförening

L11J

26.10.2019

Rottne Industri Cup 2019

Söraby SKF

Serie 1

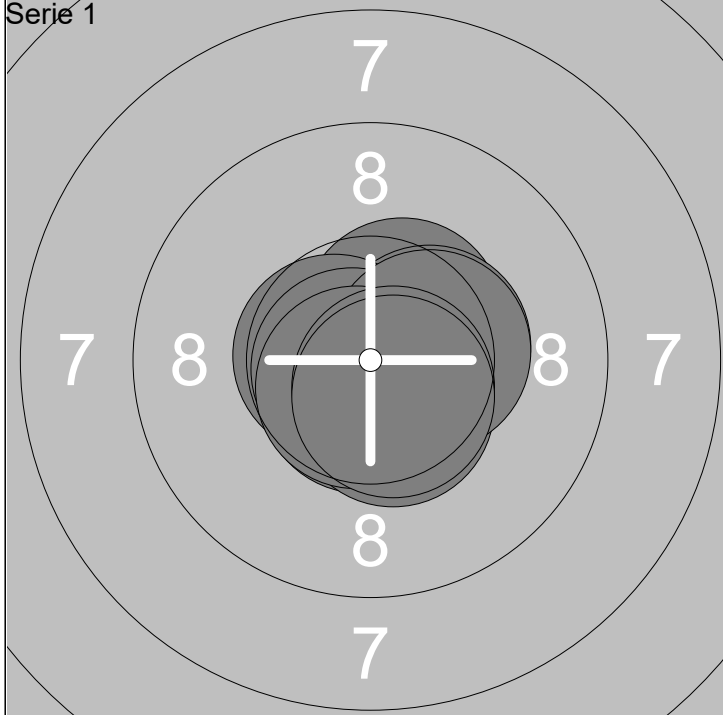

Serie 2

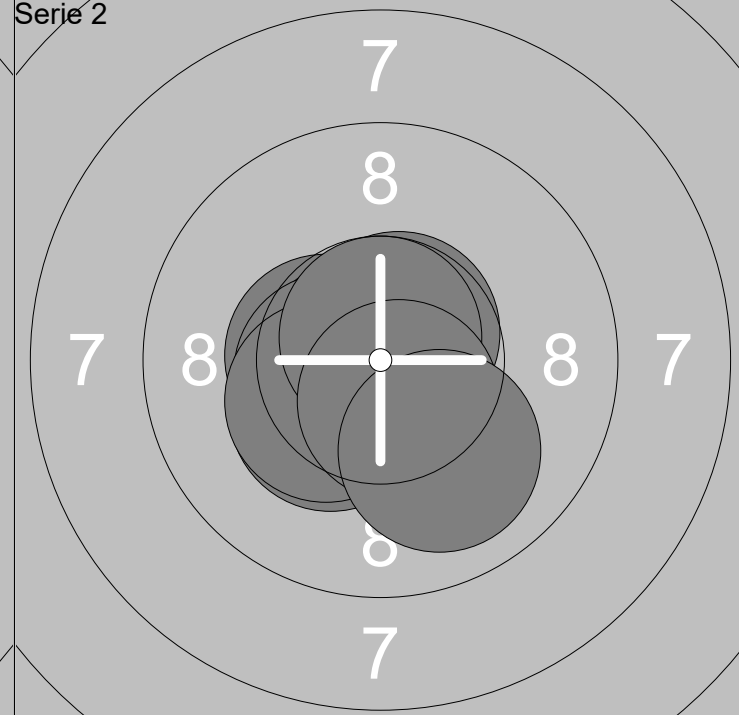

1: 10.5x ↗	6: 10.5x ↓
2: 10.4x →	7: 10.4x →
3: 10.6x ←	8: 10.7x ↓
4: 10.8x ←	9: 10.6x ↓
5: 10.6x ↓	10: 10.6x ↓

Serie	105.7
Total	105.7

11: 10.7x ↗	16: 10.6x ↓
12: 10.3x ↙	17: 10.3x ↙
13: 10.5x ←	18: 10.8x ↑
14: 10.7x ←	19: 10.5x ↓
15: 10.5x ←	20: 10.0 ↓

Serie	104.9
Total	210.6

Serie 3

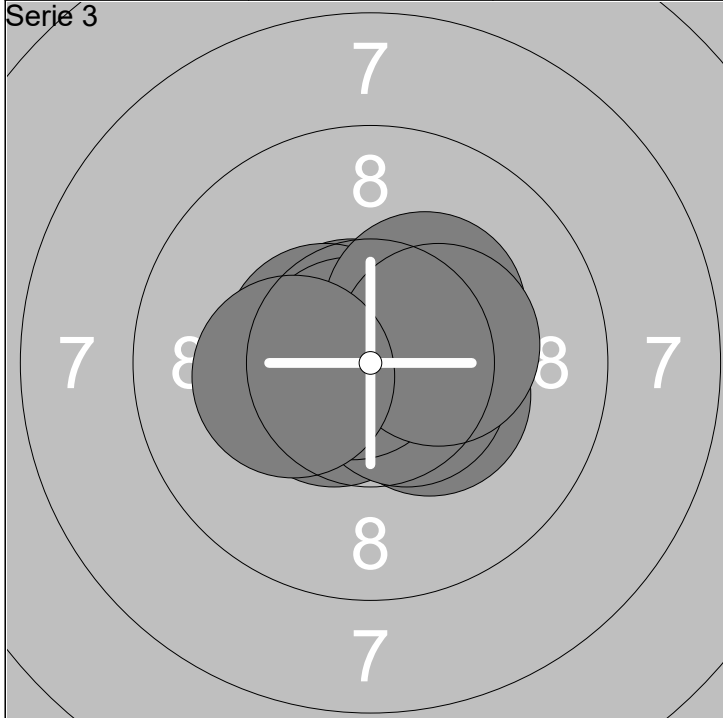

Serie 4

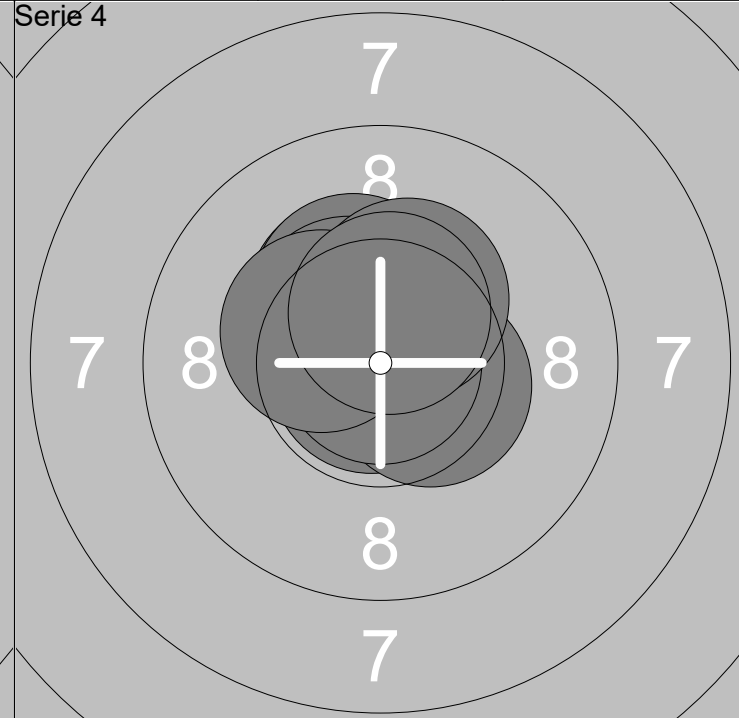

21: 10.6x →	26: 10.5x ←
22: 10.6x ←	27: 10.8x ←
23: 10.4x →	28: 10.3x ↗
24: 10.6x ↓	29: 10.3x →
25: 10.7x ↗	30: 10.2x ←

Serie	105.0
Total	315.6

31: 10.3x ↗	36: 10.5x ↗
32: 10.7x →	37: 10.9x
33: 10.8x ↙	38: 10.4x ↙
34: 10.3x ↗	39: 10.3x ↗
35: 10.5x →	40: 10.5x ↑

Serie	105.2
Total	420.8

Rottne Industri Cup 2019

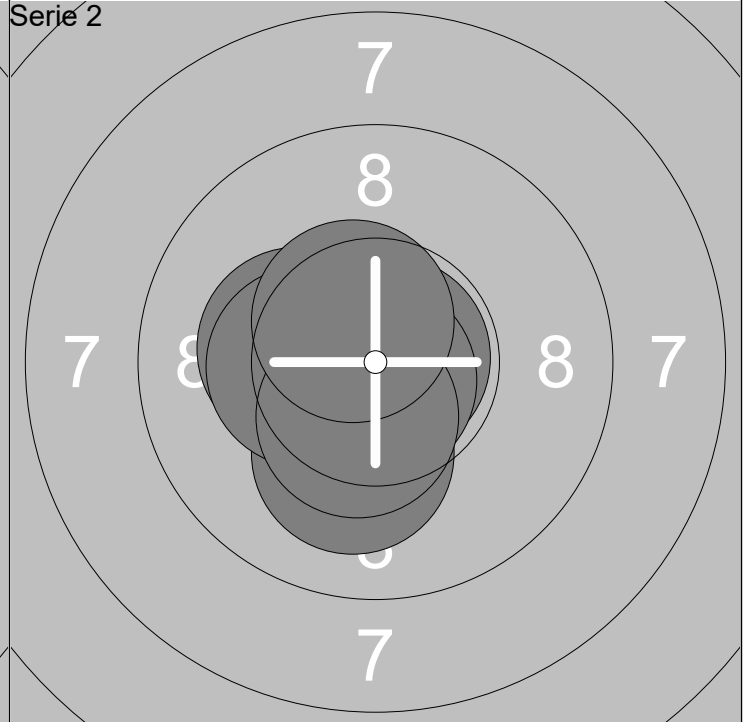
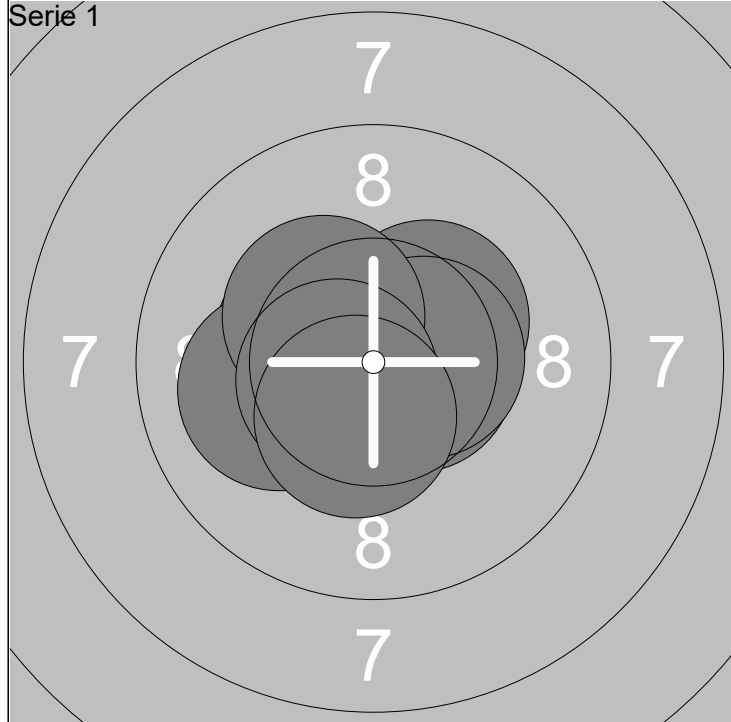

1: 10.4x ←	6: 10.1 ←	Serie	104.3
2: 10.5x →	7: 10.5x →		
3: 10.4x ↗	8: 10.3x ↖	Total	104.3
4: 10.4x ←	9: 10.6x ←		
5: 10.6x →	10: 10.5x ↓		

11: 10.3x ←	16: 10.3x ←	Serie	105.3
12: 10.7x ←	17: 10.8x →		
13: 10.6x ↓	18: 10.8x ↓	Total	209.6
14: 10.8x ↖	19: 10.4x ↓		
15: 10.1 ↓	20: 10.5x ↖		

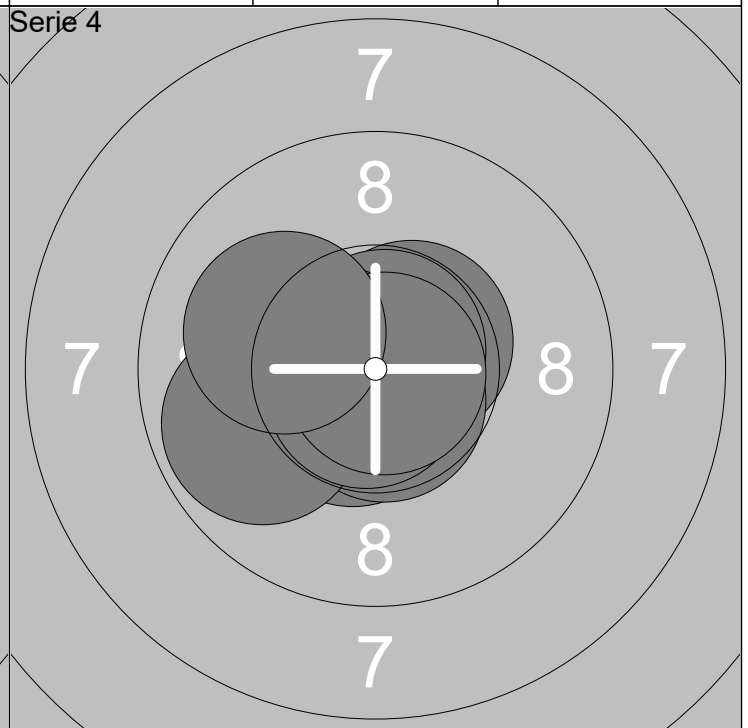
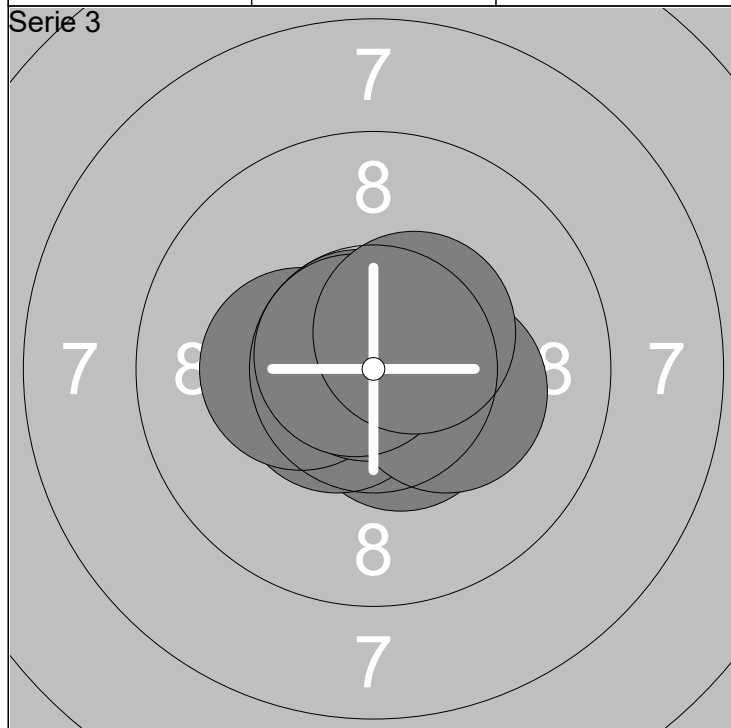

21: 10.8x ←	26: 10.3x ←	Serie	106.1
22: 10.5x ↓	27: 10.8x ↖		
23: 10.6x ←	28: 10.3x →	Total	315.7
24: 10.7x ↖	29: 10.8x ↖		
25: 10.8x ↗	30: 10.5x ↗		

31: 10.6x ↓	36: 10.6x ←	Serie	105.6
32: 10.7x ↓	37: 9.9 ←		
33: 10.6x ↗	38: 10.8x ↓	Total	421.3
34: 10.7x ↓	39: 10.8x →		
35: 10.8x ↗	40: 10.1 ←		

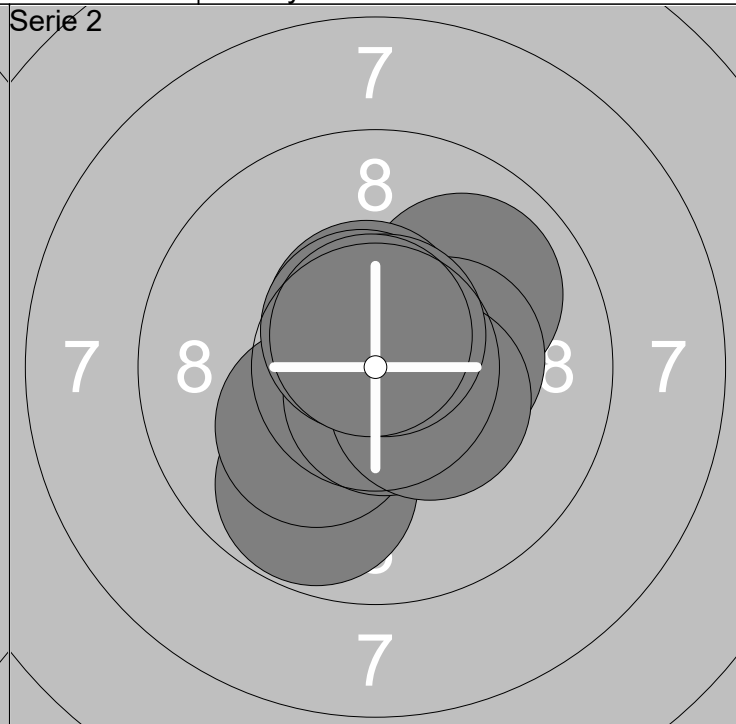
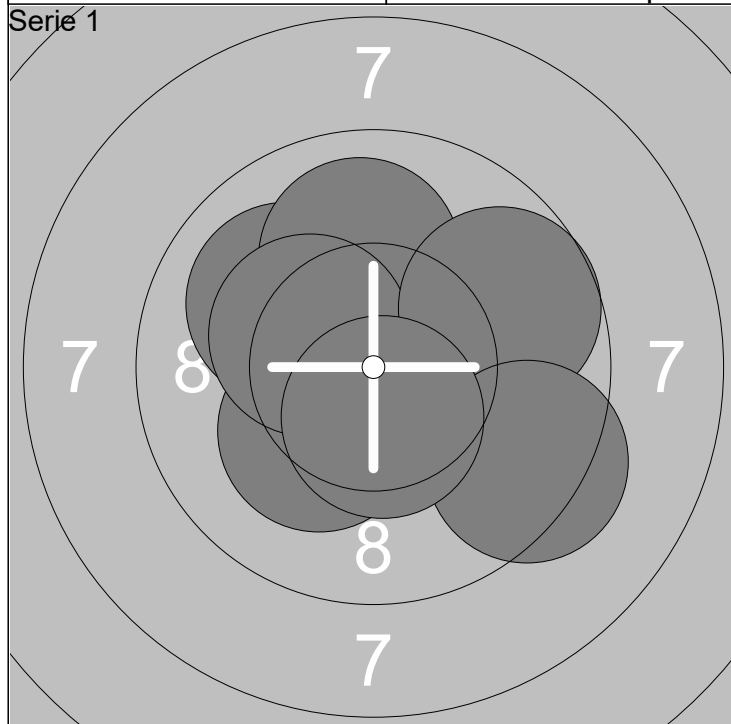

1: 10.5x ↖	6: 10.0 ↑	Serie	102.0
2: 10.6x ↗	7: 10.3x ↖		
3: 10.0 ↖	8: 9.7 ↗	Total	102.0
4: 10.2x ↙	9: 9.3 ↘		
5: 10.9x →	10: 10.5x ↓		

11: 9.8 ↙	16: 10.6x ↑	Serie	104.0
12: 10.2x ↙	17: 10.4x →		
13: 10.0 ↗	18: 10.6x ↑	Total	206.0
14: 10.3x →	19: 10.7x ↑		
15: 10.7x ↓	20: 10.7x ↑		

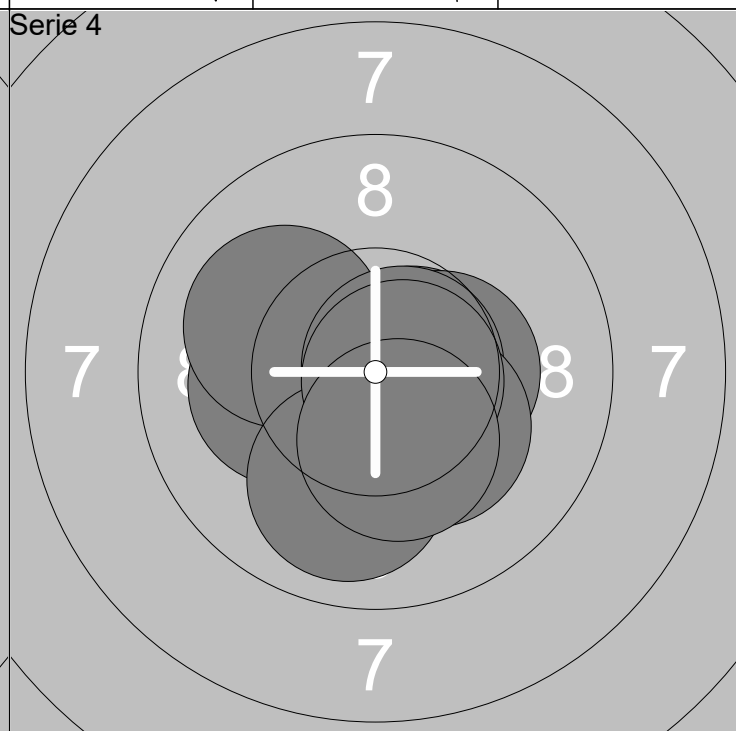
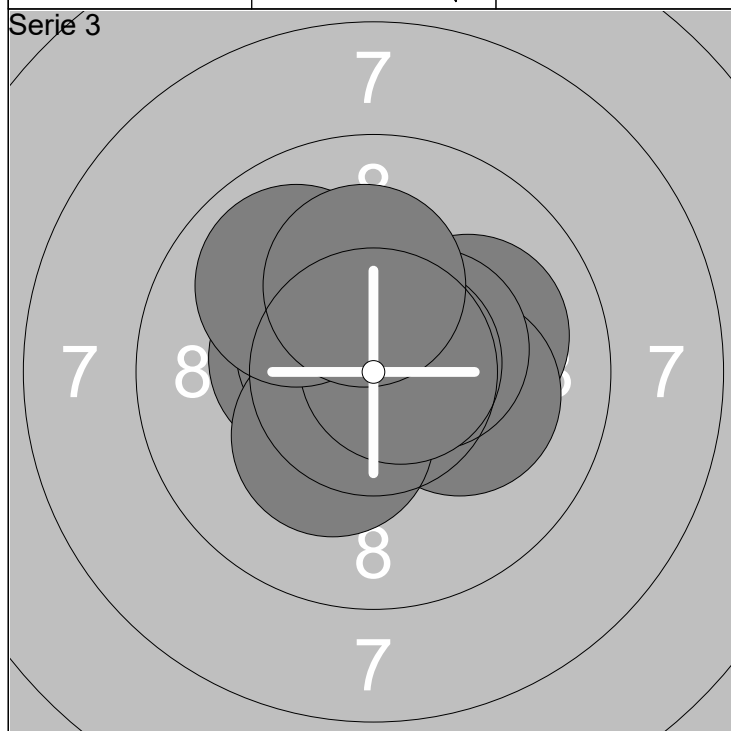

21: 10.3x →	26: 10.4x ↗	Serie	103.0
22: 10.0 →	27: 10.3x ↙		
23: 10.4x ←	28: 10.7x ↗	Total	309.0
24: 10.6x ↖	29: 9.9 ↖		
25: 10.2x →	30: 10.2x ↑		

31: 10.5x ↓	36: 10.7x →	Serie	103.8
32: 10.6x →	37: 10.0 ↓		
33: 10.4x →	38: 10.3x ↙	Total	412.8
34: 10.2x ←	39: 10.7x →		
35: 10.1 ↖	40: 10.3x ↓		

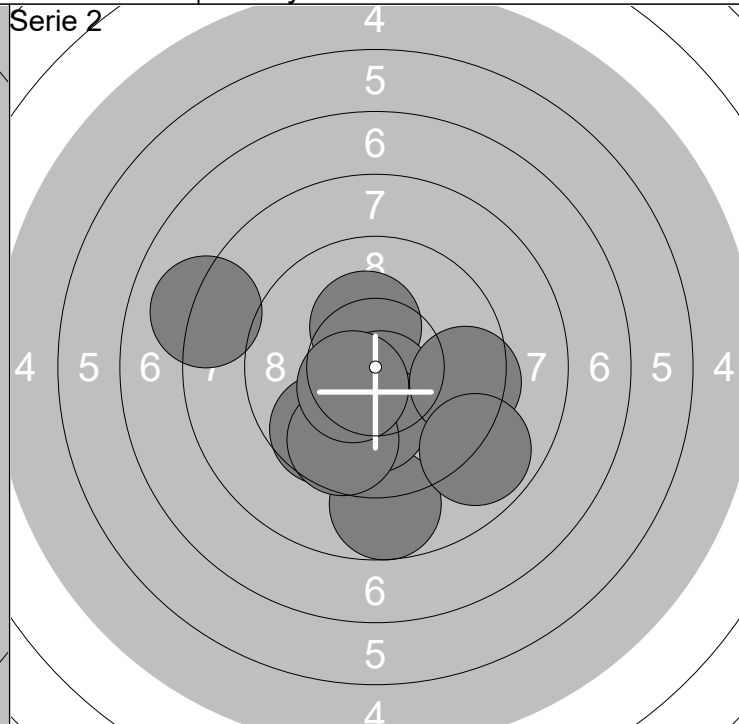
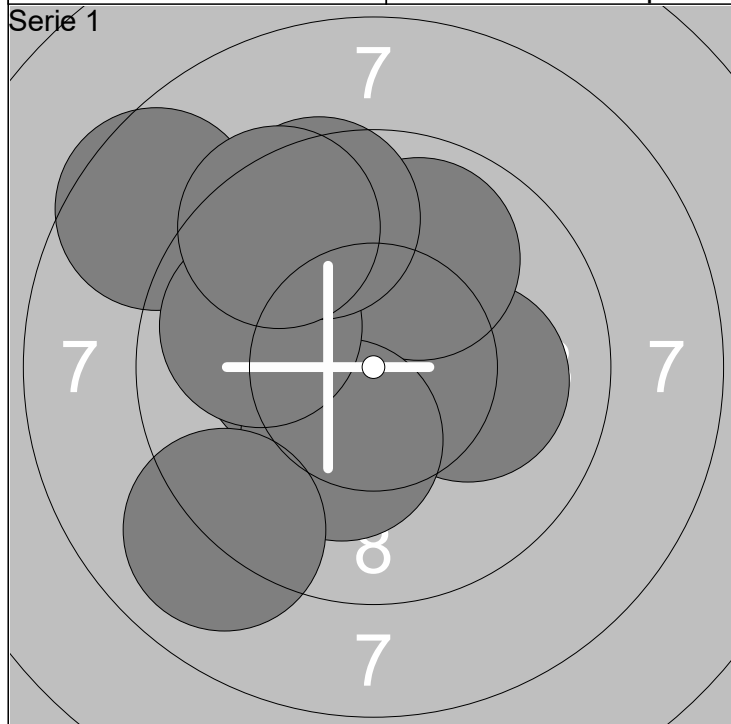

1: 8.6 ↖	6: 10.3x ↓	Serie	97.7
2: 10.3x ←	7: 9.0 ↓		
3: 10.6x →	8: 9.9 ↖	Total	97.7
4: 10.1 →	9: 9.5 ↗		
5: 9.9 ↗	10: 9.5 ↖		

11: 9.7 ↙	16: 9.5 →	Serie	96.2
12: 10.3x ↗	17: 8.9 ↓		
13: 10.6x ↓	18: 9.7 ↓	Total	193.9
14: 8.8 ↓	19: 10.5x ↙		
15: 10.1 ↓	20: 8.1 ←		

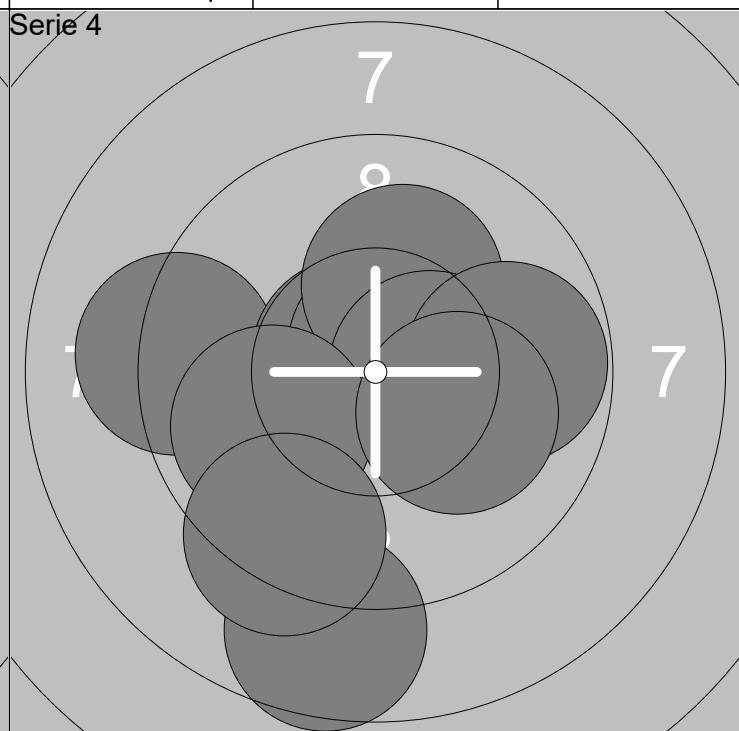
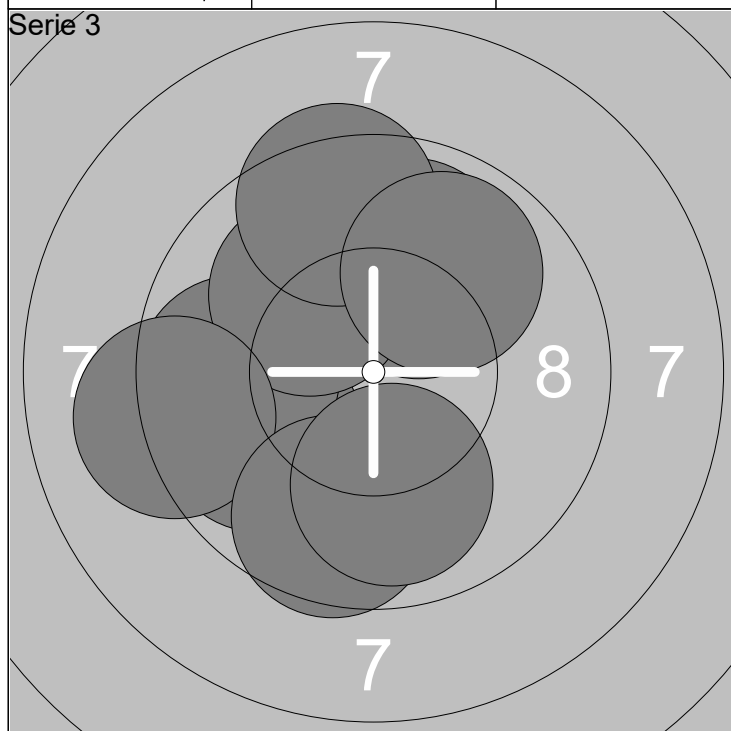

21: 9.8 ↖	26: 9.1 ←	Serie	97.4
22: 9.9 ↗	27: 9.6 ↓		
23: 9.7 ←	28: 9.9 ↓	Total	291.3
24: 10.0 ↗	29: 9.4 ↗		
25: 10.1 ↖	30: 9.9 ↗		

31: 9.2 ←	36: 10.5x →	Serie	98.9
32: 8.6 ↓	37: 9.8 →		
33: 10.7x ↖	38: 9.9 ↖	Total	390.2
34: 10.7x ↗	39: 9.3 ↓		
35: 10.1 ↗	40: 10.1 ↘		

Serie 1

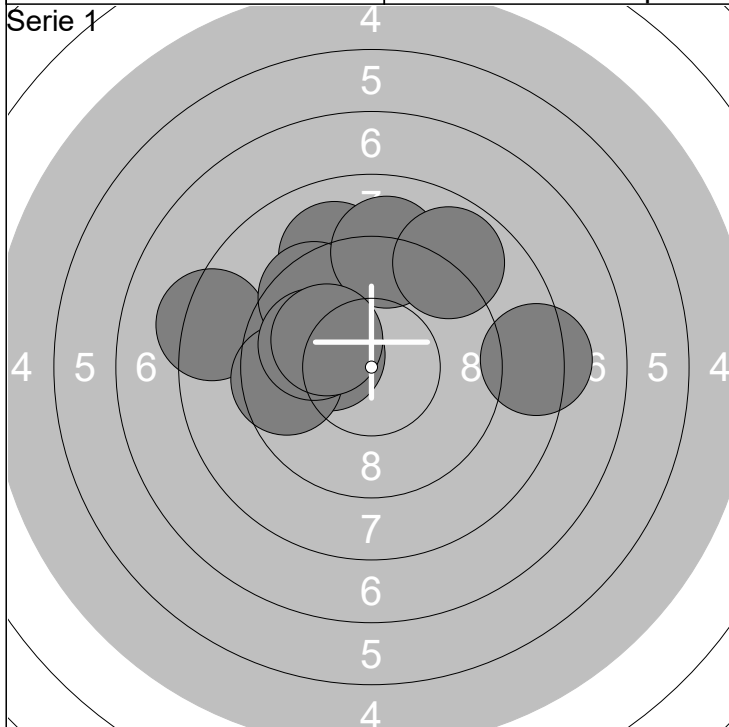

Serie 2

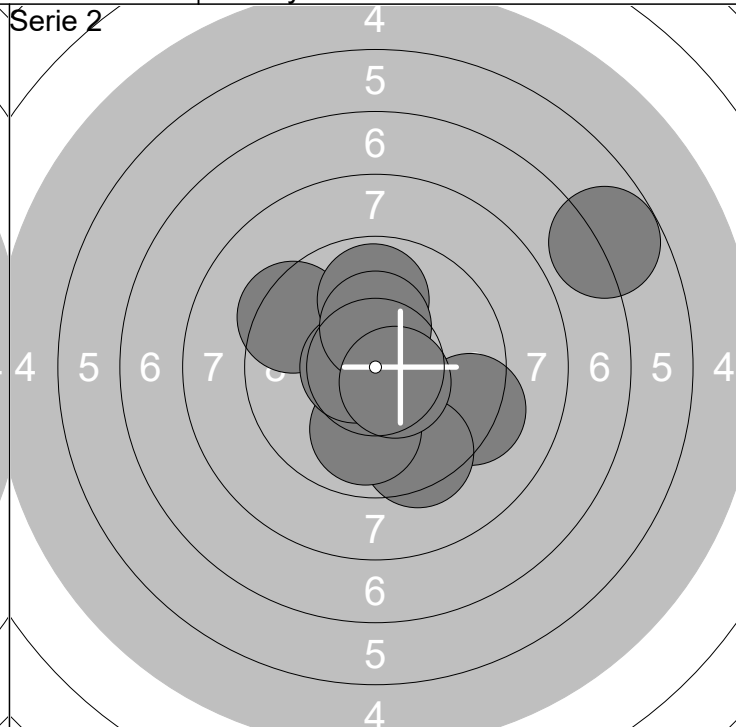

1: 10.2x ↙	6: 9.5 ↗
2: 8.3 ↙	7: 10.0 ↙
3: 9.1 ↗	8: 9.1 ↗
4: 8.3 →	9: 10.1 ↖
5: 9.6 ←	10: 8.9 ↗

Serie	93.1
Total	93.1

11: 9.3 →	16: 10.8x ↘
12: 9.4 ↖	17: 9.9 ↓
13: 9.4 ↘	18: 10.6x ←
14: 9.9 ↑	19: 10.3x ↑
15: 6.8 ↗	20: 10.6x ↘

Serie	97.0
Total	190.1

Serie 3

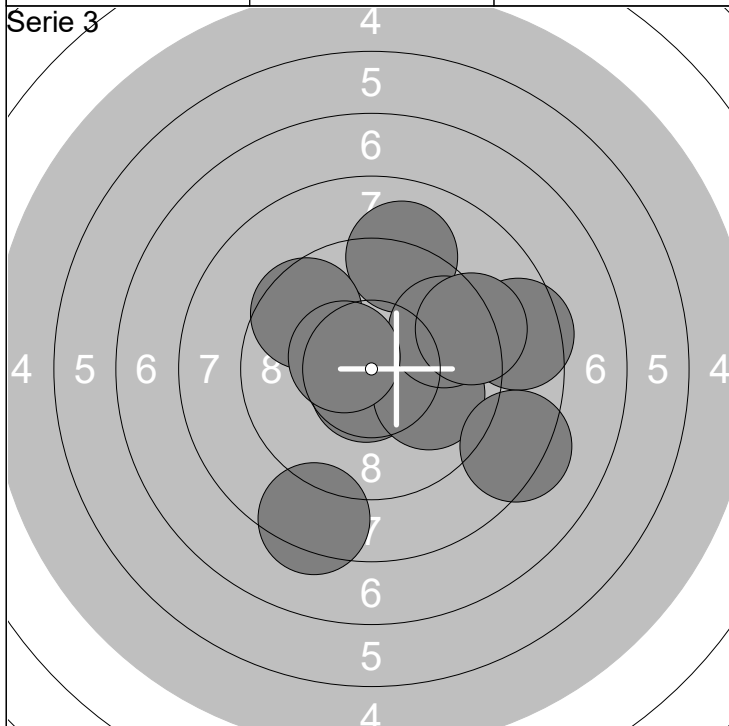

Serie 4

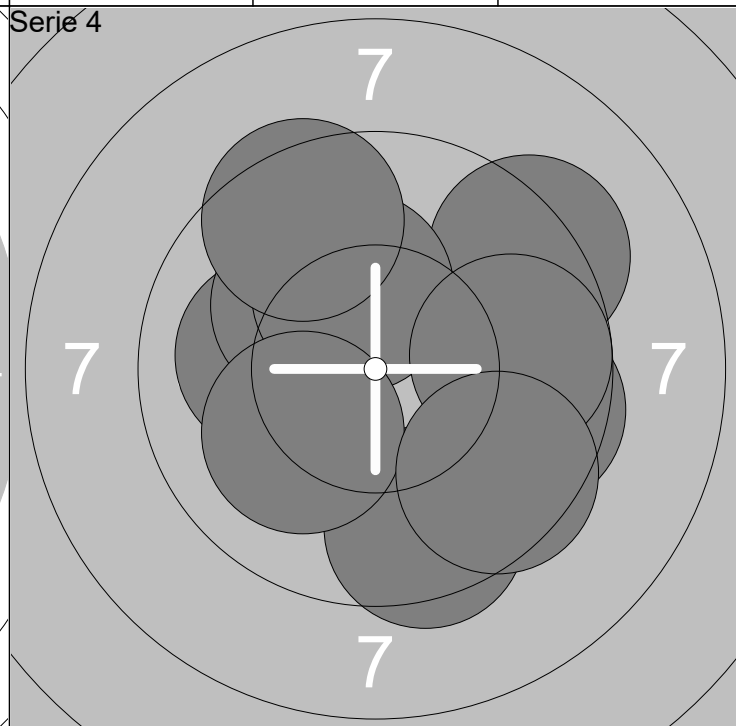

21: 10.6x ↓	26: 9.6 ↗
22: 10.0 →	27: 8.5 →
23: 9.1 ↗	28: 9.2 →
24: 8.4 ↓	29: 8.3 ↘
25: 9.6 ↖	30: 10.5x ↖

Serie	93.8
Total	283.9

31: 9.6 →	36: 9.7 →
32: 9.2 ↗	37: 9.5 ↓
33: 10.1 ←	38: 9.5 ↗
34: 10.2x ↖	39: 10.1 ↘
35: 10.2x ↑	40: 9.5 ↘

Serie	97.6
Total	381.5

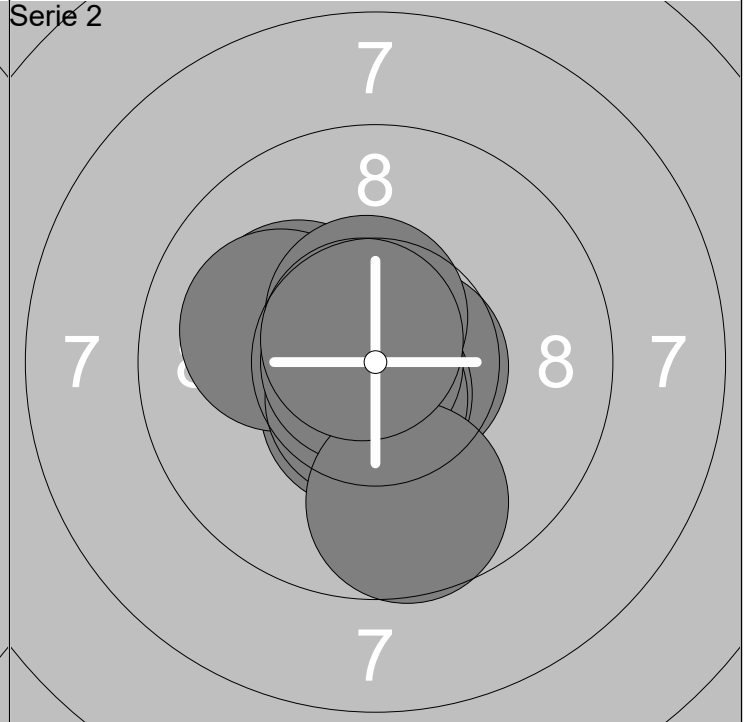
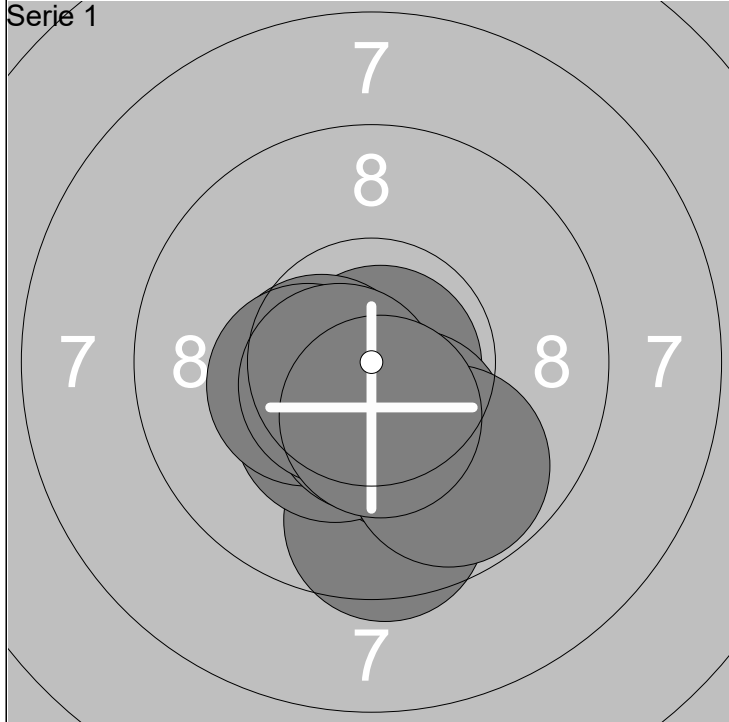

1: 10.9x →	6: 9.8 ↓	Serie 103.2
2: 9.5 ↓	7: 10.3x ←	
3: 10.3x ↓	8: 10.5x ↓	Total 103.2
4: 10.5x ←	9: 10.6x ←	
5: 10.3x ↙	10: 10.5x ↓	

11: 10.5x ↓	16: 10.6x ↓	Serie 104.5
12: 10.7x →	17: 10.8x ←	
13: 10.7x ↓	18: 9.7 ↓	Total 207.7
14: 10.2x ↖	19: 10.5x ↑	
15: 10.1 ←	20: 10.7x ↗	

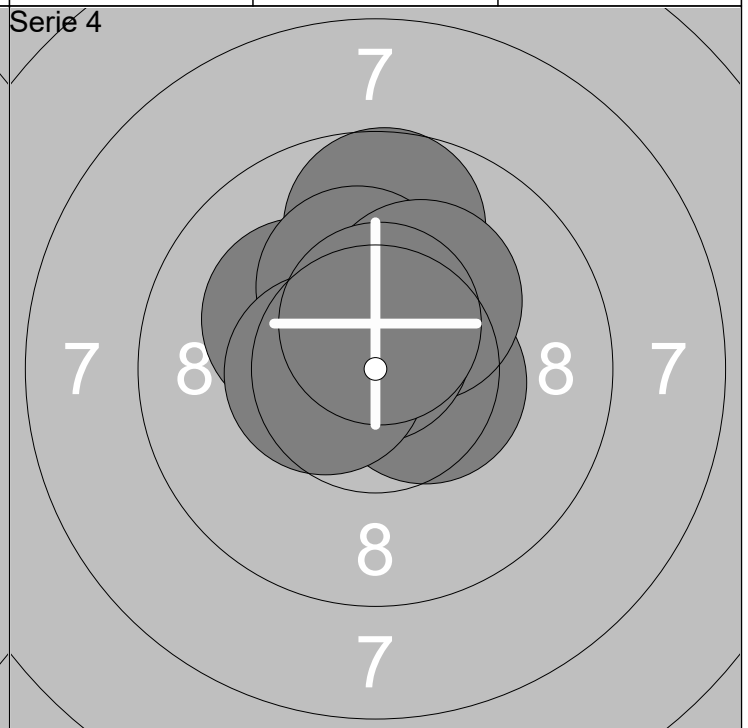
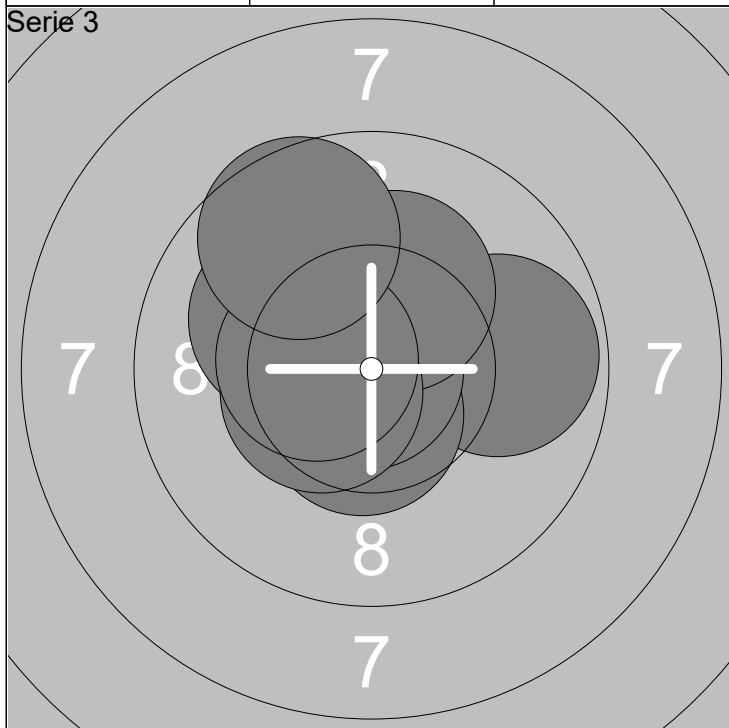

21: 10.8x ↓	26: 10.9x ←	Serie 103.1
22: 9.8 →	27: 10.2x ↑	
23: 10.5x ↓	28: 10.4x ←	Total 310.8
24: 10.1 ↖	29: 10.5x ←	
25: 10.3x ↑	30: 9.6 ↗	

31: 10.2x ↖	36: 10.2x ↑	Serie 103.6
32: 10.7x ↗	37: 10.2x ↗	
33: 10.4x ↑	38: 10.7x ↑	Total 414.4
34: 9.7 ↑	39: 10.5x ←	
35: 10.5x →	40: 10.5x ↑	

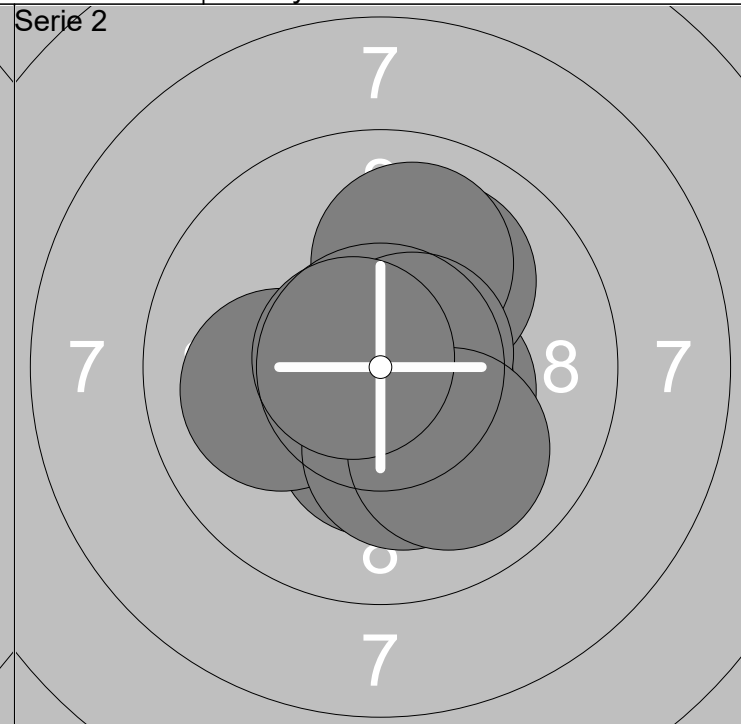
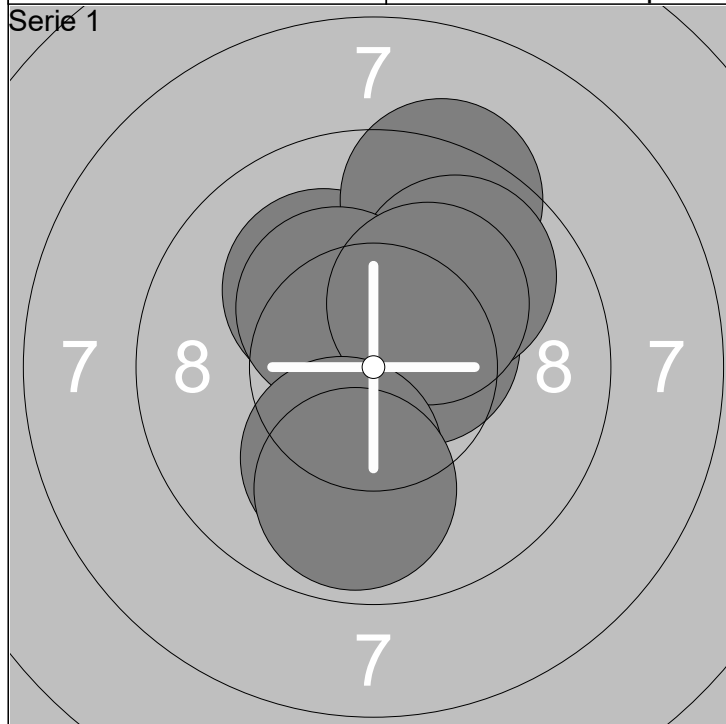

1: 10.3x ↗	6: 9.9 ↗	Serie	101.3	11: 10.4x ↓	16: 10.0 ↗	Serie	103.0
2: 10.8x ↗	7: 10.3x ↘			12: 10.4x ➔	17: 10.6x ➔		
3: 10.5x ➔	8: 10.2x ↗	Total	101.3	13: 10.0 ←	18: 10.2x ↓	Total	204.3
4: 10.1 ↖	9: 10.1 ↓			14: 10.6x ➔	19: 10.0 ↓		
5: 9.3 ↗	10: 9.8 ↓			15: 10.1 ↗	20: 10.7x ←		

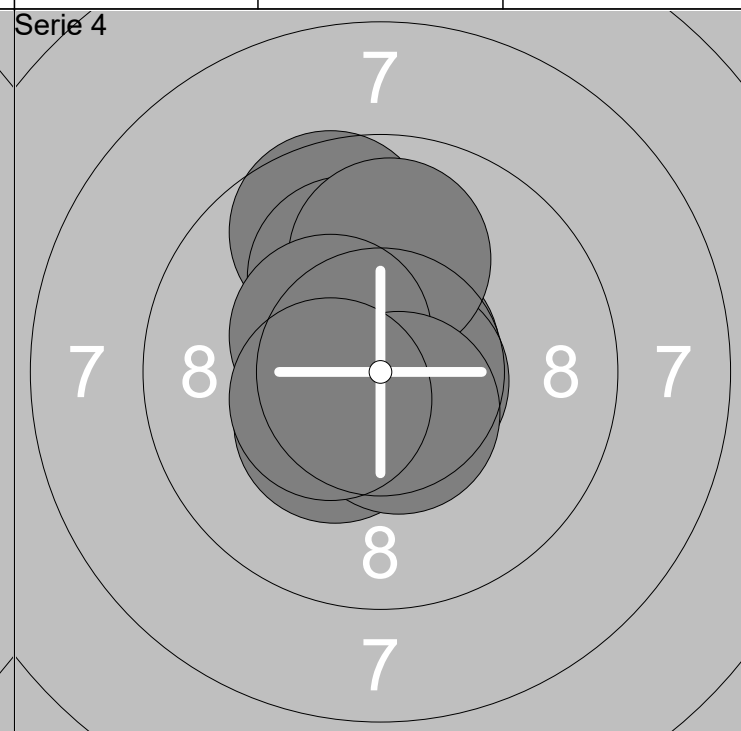
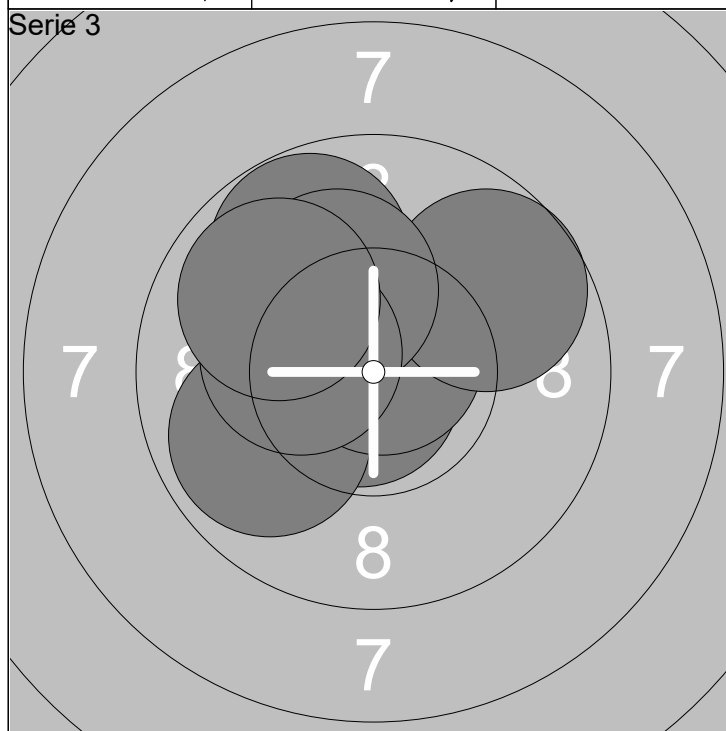

21: 10.8x ↖	26: 9.8 ↗	Serie	101.9	31: 9.6 ↗	36: 10.7x ←	Serie	103.5
22: 9.9 ↖	27: 9.7 ↗			32: 10.7x ↗	37: 9.9 ↗		
23: 10.3x ↖	28: 10.2x ↗	Total	306.2	33: 10.0 ↗	38: 10.4x ↖	Total	409.7
24: 10.2x ↗	29: 10.3x ←			34: 10.4x ↖	39: 10.6x ↓		
25: 10.8x ↗	30: 9.9 ↖			35: 10.7x ➔	40: 10.5x ←		



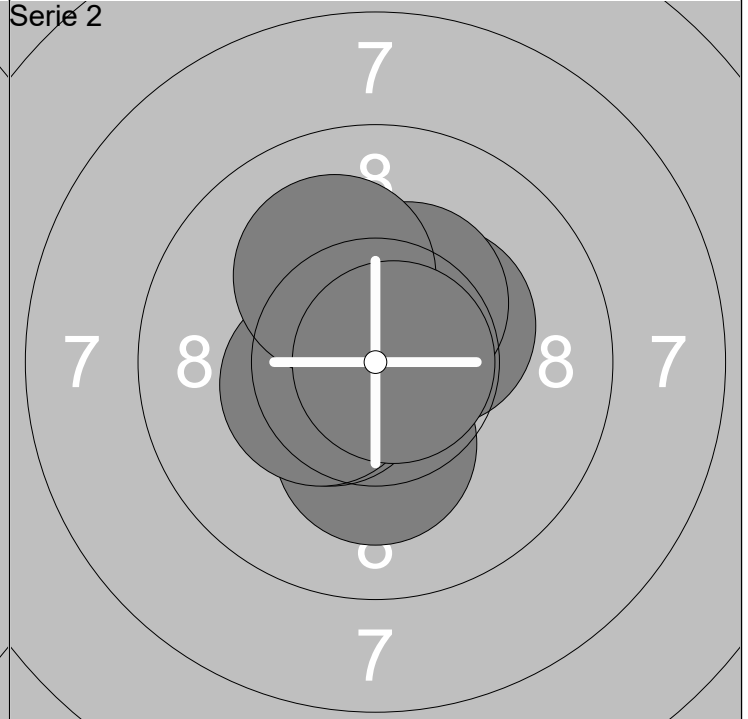
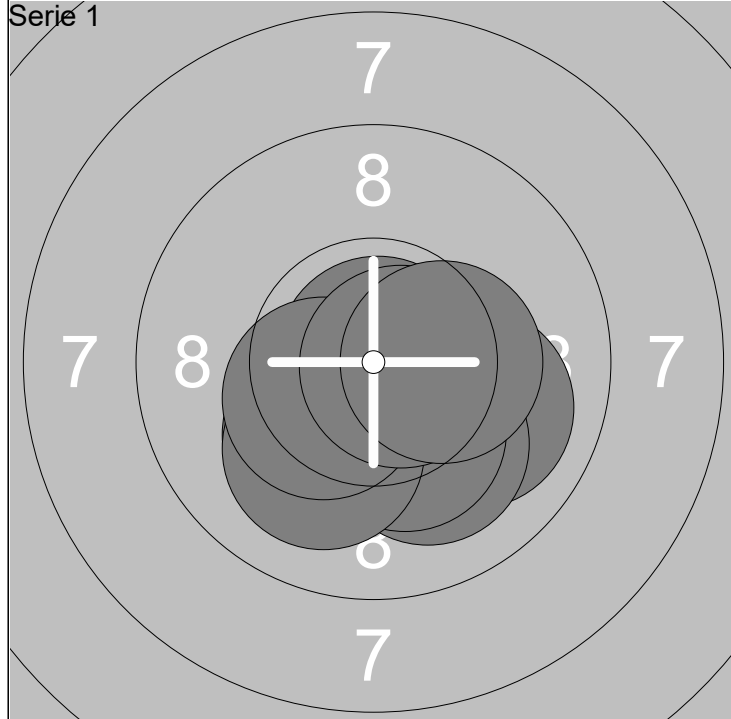

1: 10.2x ↙	6: 10.9x ↗	Serie 103.6
2: 10.0 →	7: 10.1 ↓	
3: 10.1 ↓	8: 10.4x ←	Total 103.6
4: 10.5x ↓	9: 10.7x →	
5: 10.3x ↓	10: 10.4x →	

11: 10.5x ↙	16: 10.3x ↗	Serie 104.3
12: 10.7x ↖	17: 10.4x ↗	
13: 10.4x ↓	18: 10.4x ←	Total 207.9
14: 10.2x ↓	19: 10.1 ↗	
15: 10.5x ↖	20: 10.8x →	

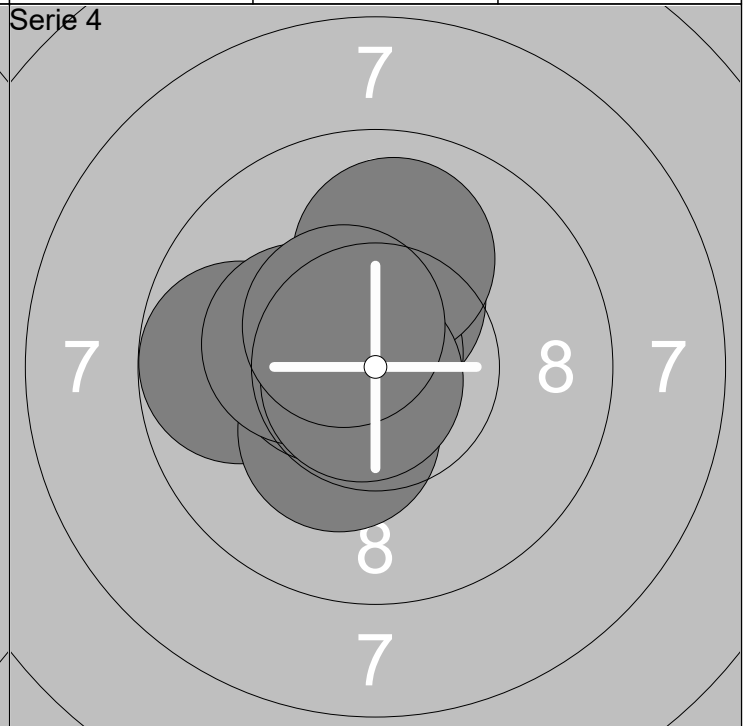
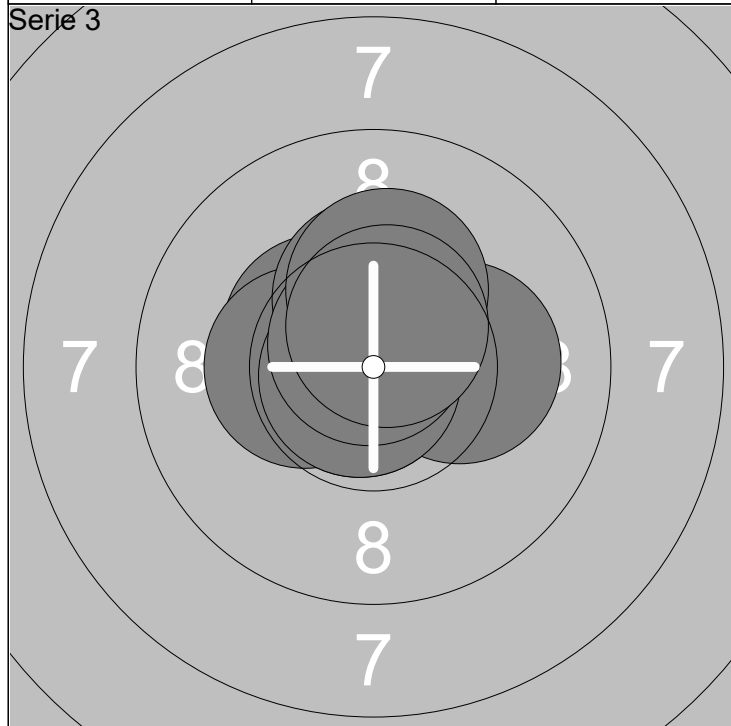

21: 10.8x ↖	26: 10.3x ↑	Serie 105.0
22: 10.4x ↖	27: 10.8x ↖	
23: 10.6x ↗	28: 10.7x ↑	Total 312.9
24: 10.3x ←	29: 10.3x ↑	
25: 10.2x →	30: 10.6x ↑	

31: 10.6x ↖	36: 10.8x ↖	Serie 104.1
32: 9.8 ←	37: 10.3x ↖	
33: 10.3x ↓	38: 10.0 ↑	Total 417.0
34: 10.6x ←	39: 10.8x ↖	
35: 10.4x ↑	40: 10.5x ↖	

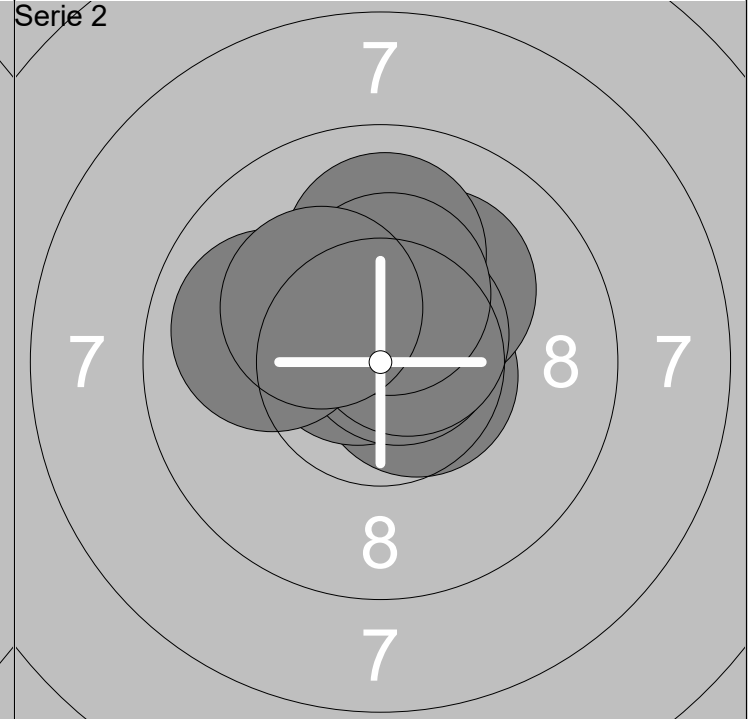
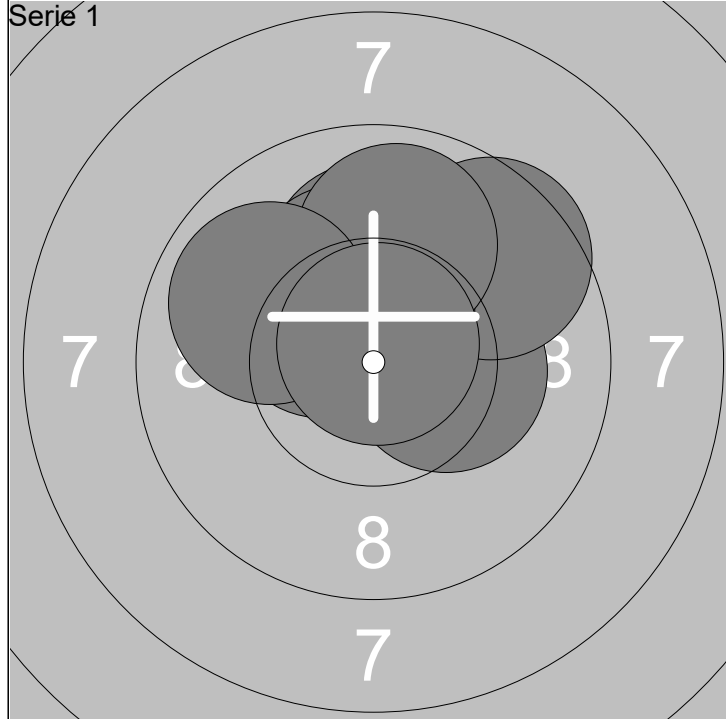

1: 10.1 ↑	6: 10.4x ↖	Serie	102.3
2: 10.6x ↑	7: 10.2x ↑		
3: 10.3x →	8: 9.9 ↑	Total	102.3
4: 9.6 ↗	9: 9.9 ↖		
5: 10.5x ↑	10: 10.8x ↑		

11: 10.6x →	16: 10.5x ↗	Serie	103.8
12: 10.2x ↗	17: 10.0 ↑		
13: 10.7x ↖	18: 10.6x ↗	Total	206.1
14: 10.7x ↗	19: 10.4x ↑		
15: 9.9 ←	20: 10.2x ↖		

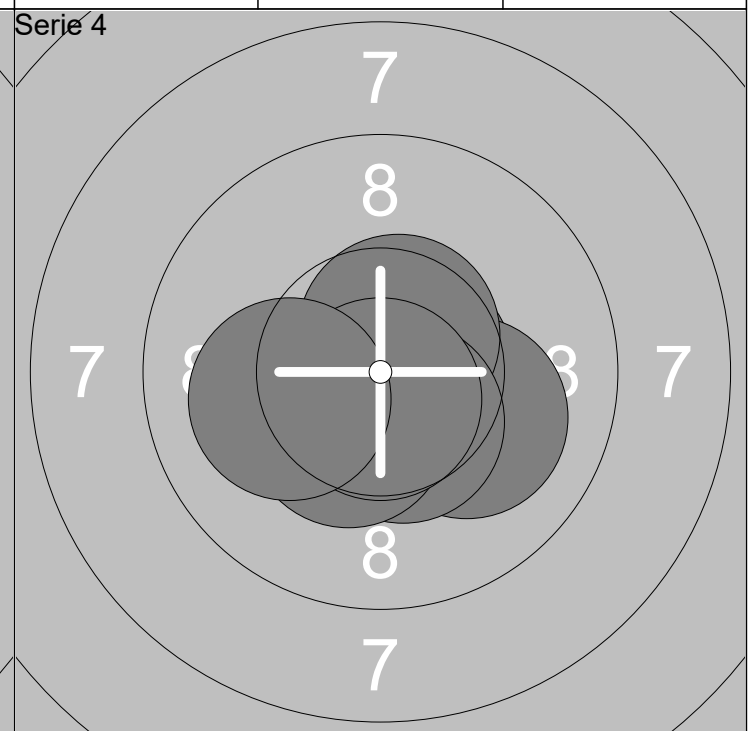
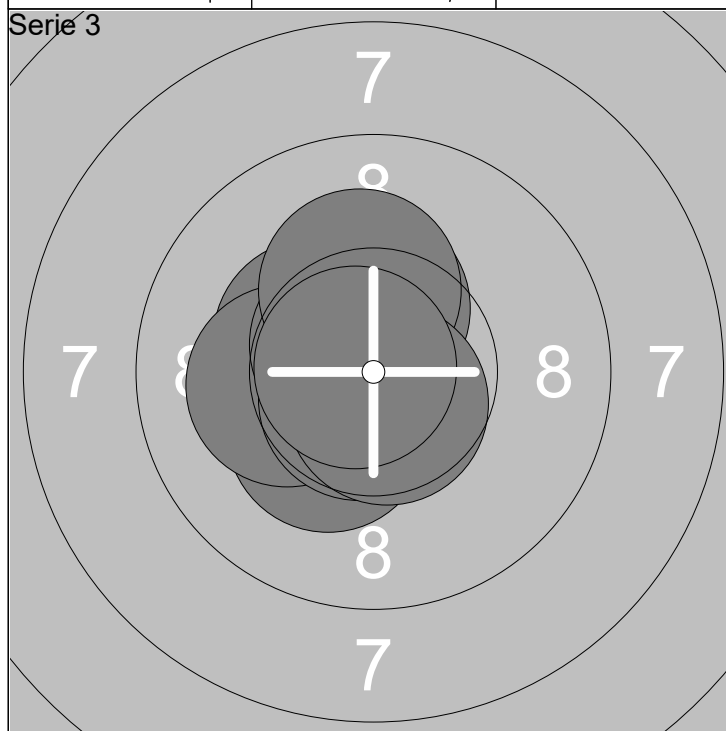

21: 10.4x ↖	26: 10.7x ↘	Serie	104.8
22: 10.3x ↘	27: 10.4x ↑		
23: 10.5x ←	28: 10.2x ↑	Total	310.9
24: 10.2x ←	29: 10.6x ↘		
25: 10.7x ↗	30: 10.8x ←		

31: 10.6x →	36: 10.6x ↗	Serie	105.3
32: 10.9x ↘	37: 10.5x ↘		
33: 10.7x →	38: 10.4x ↘	Total	416.2
34: 10.7x ↗	39: 10.7x ↘		
35: 10.1 →	40: 10.1 ←		

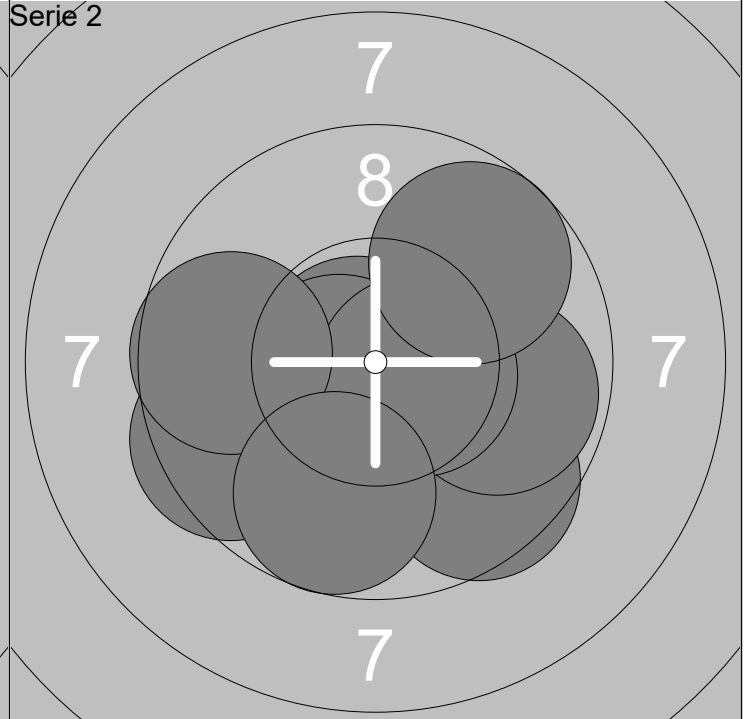
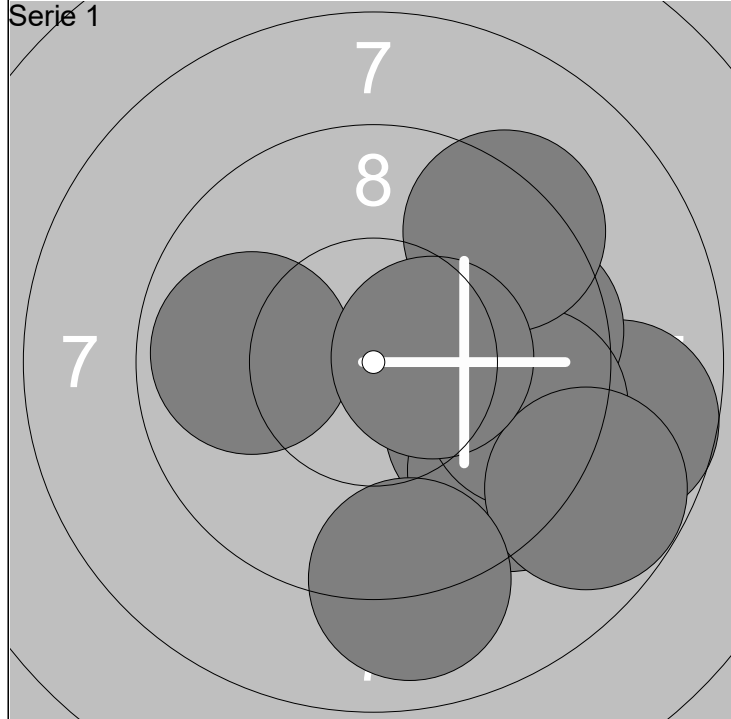

1: 9.8 ↘	6: 9.9 ←	Serie 94.4
2: 8.7 →	7: 8.8 ↘	
3: 9.4 ↘	8: 9.0 ↓	Total 94.4
4: 9.6 →	9: 9.3 ↗	
5: 9.5 →	10: 10.4x →	

11: 10.8x ←	16: 10.5x →	Serie 100.3
12: 10.6x ←	17: 9.5 ←	
13: 10.4x ↓	18: 9.7 ←	Total 194.7
14: 9.6 ↓	19: 9.7 ↓	
15: 9.8 →	20: 9.7 ↗	

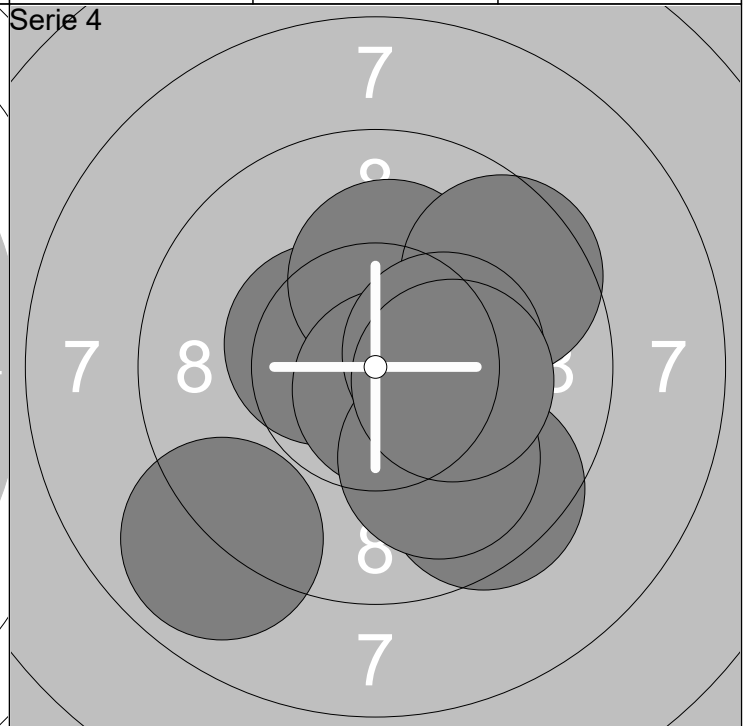
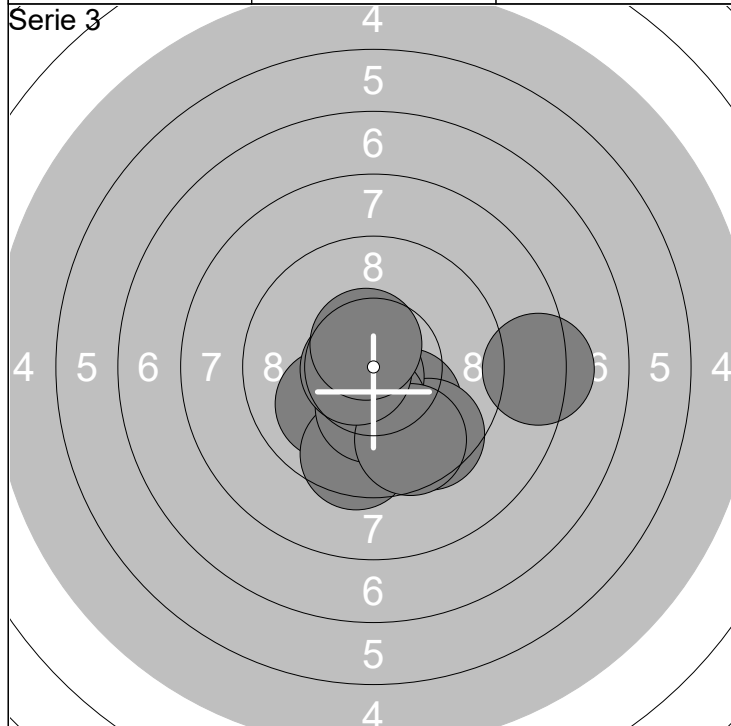

21: 10.0 ↙	26: 10.8x ↓	Serie 99.6
22: 8.3 →	27: 10.3x ↓	
23: 9.5 ↓	28: 9.7 ↓	Total 294.3
24: 10.1 ↓	29: 10.7x ←	
25: 9.6 ↓	30: 10.6x ↑	

31: 10.6x ↑	36: 9.6 ↗	Serie 100.7
32: 10.5x ←	37: 8.9 ↙	
33: 10.2x ↑	38: 10.0 ↓	Total 395.0
34: 9.5 ↓	39: 10.4x →	
35: 10.7x ↓	40: 10.3x →	

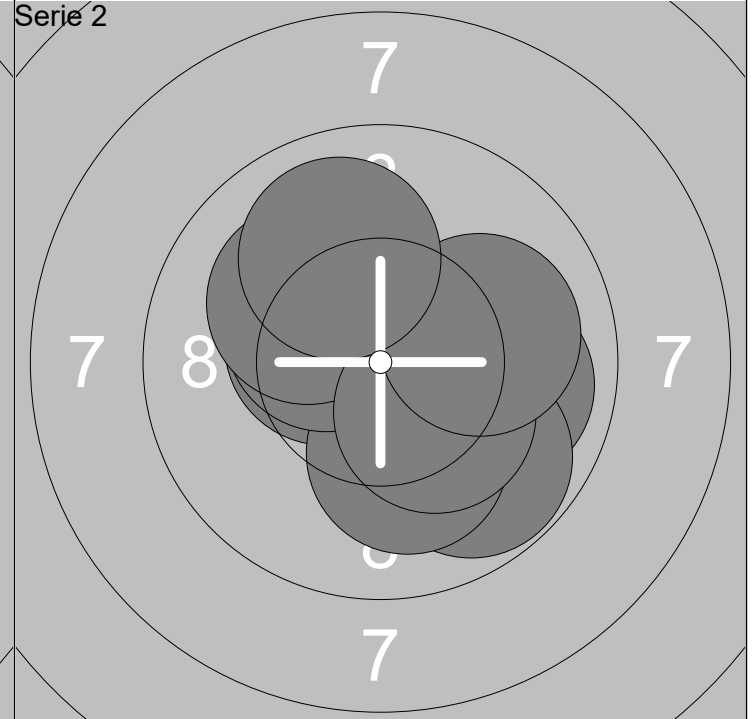
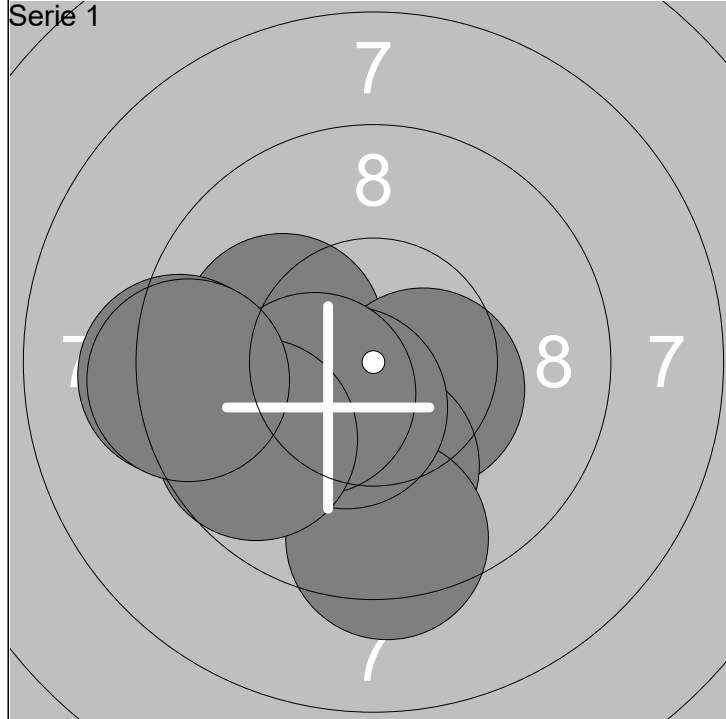

1: 10.1 ↖	6: 10.5x ↘	Serie	99.4
2: 10.4x →	7: 9.2 ←		
3: 10.4x ↘	8: 10.4x ←	Total	99.4
4: 10.0 ↓	9: 9.7 ↙		
5: 9.4 ↓	10: 9.3 ←		

11: 10.5x ↖	16: 10.4x ↖	Serie	101.5
12: 10.4x →	17: 10.1 ↗		
13: 9.9 →	18: 10.3x ↘	Total	200.9
14: 9.8 ↘	19: 10.0 →		
15: 10.1 ↓	20: 10.0 ↗		

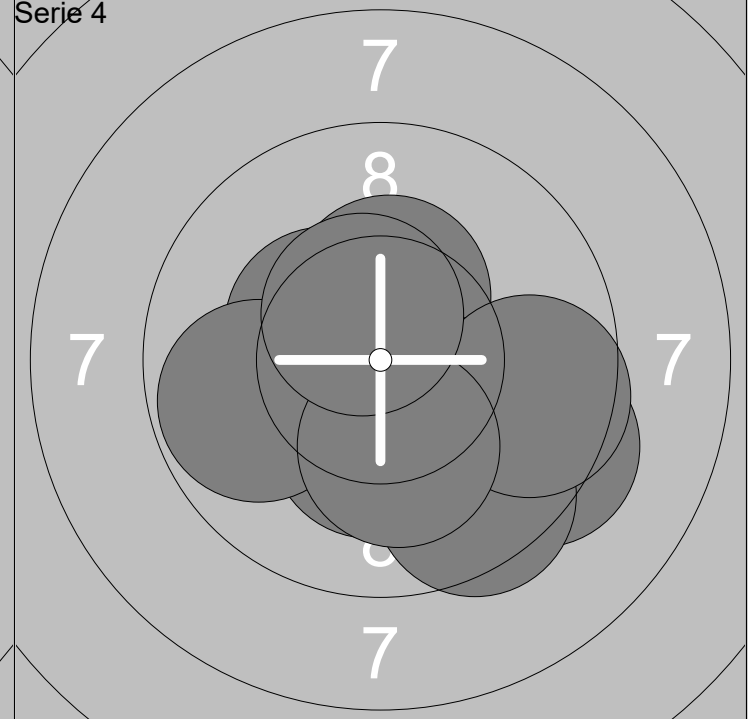
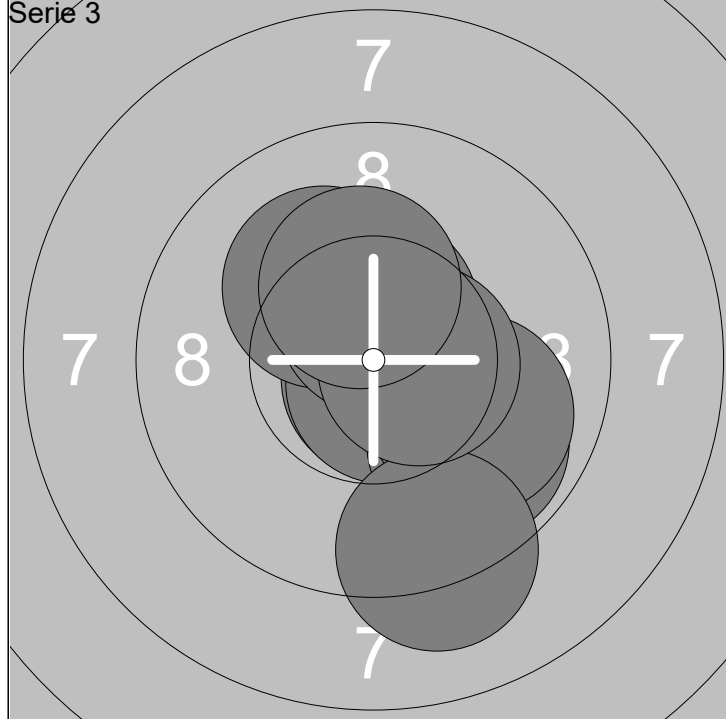

21: 10.8x ↘	26: 10.2x ↗	Serie	102.6
22: 10.6x ↑	27: 9.2 ↓		
23: 10.7x ↘	28: 10.5x ↑	Total	303.5
24: 9.9 ↘	29: 10.5x →		
25: 9.9 ↘	30: 10.3x ↑		

31: 10.4x ↑	36: 9.5 ↓	Serie	100.0
32: 10.0 ↘	37: 9.8 ←		
33: 10.4x ↖	38: 9.6 →	Total	403.5
34: 10.3x ↓	39: 10.2x ↓		
35: 9.3 ↘	40: 10.5x ↗		

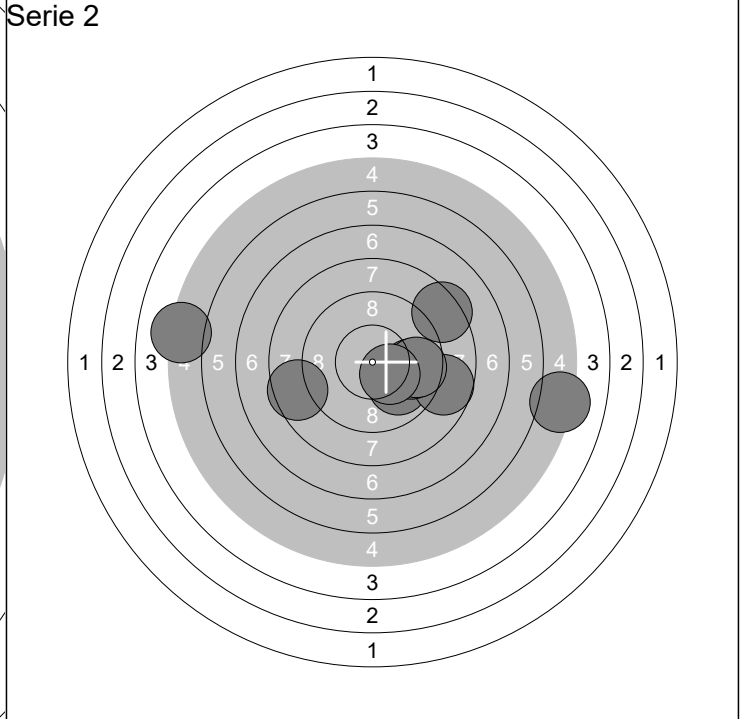
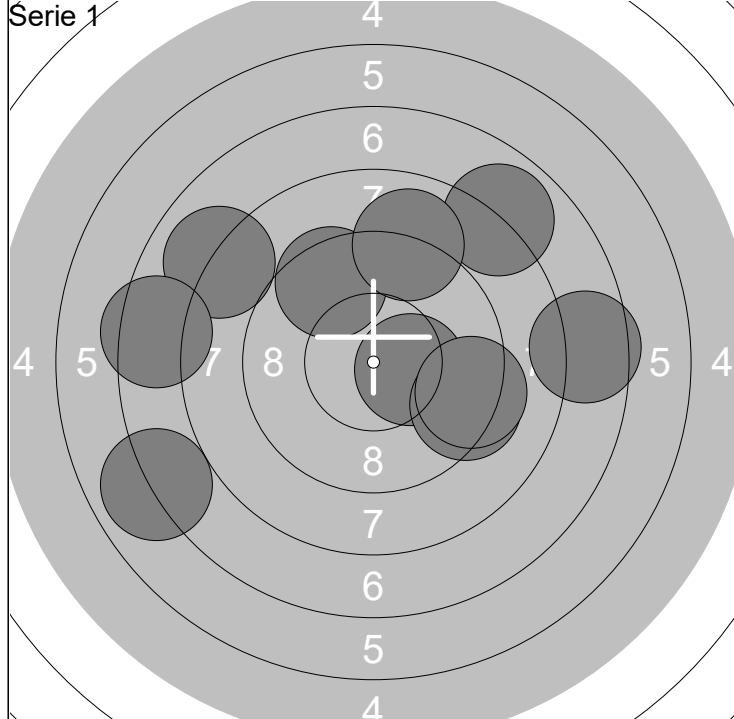

1: 8.0 ↖	6: 7.4 ←	Serie	85.2
2: 7.5 →	7: 7.9 ↗		
3: 10.3x →	8: 9.3 →	Total	85.2
4: 9.5 ↗	9: 7.0 ↖		
5: 9.3 →	10: 9.0 ↑		

11: 8.6 ←	16: 8.7 →	Serie	85.8
12: 8.4 ↗	17: 5.2 →		
13: 10.1 →	18: 9.8 →	Total	171.0
14: 9.9 ↘	19: 9.6 →		
15: 5.2 ←	20: 10.3x ↘		

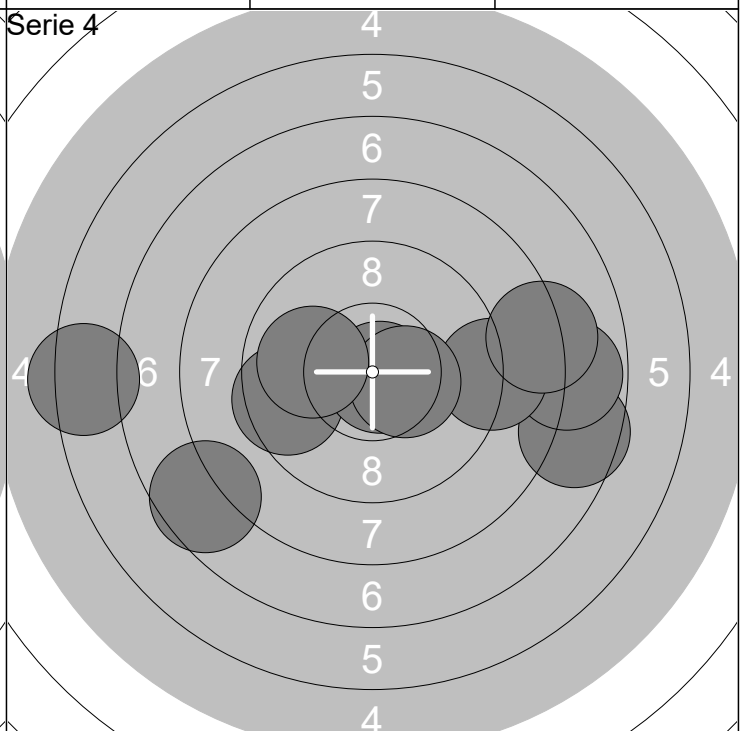
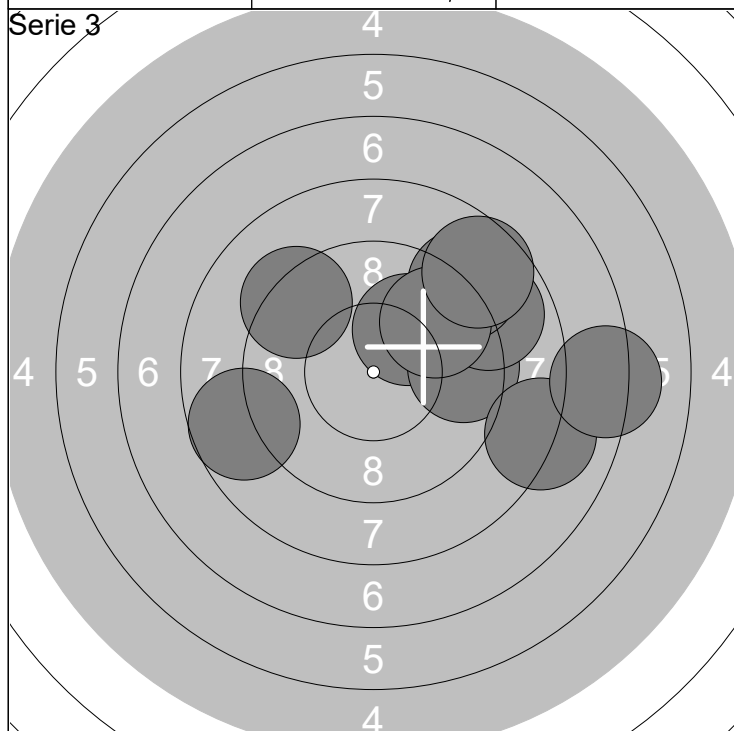

21: 8.7 ←	26: 8.1 →	Serie	89.0
22: 10.0 ↗	27: 7.2 →		
23: 9.3 ↖	28: 8.9 ↗	Total	260.0
24: 9.5 →	29: 9.7 ↗		
25: 8.9 →	30: 8.7 ↗		

31: 7.6 →	36: 6.3 ←	Serie	87.2
32: 7.8 →	37: 10.8x ↘		
33: 7.6 ↖	38: 10.4x →	Total	347.2
34: 9.0 →	39: 8.2 →		
35: 9.5 ←	40: 10.0 ←		

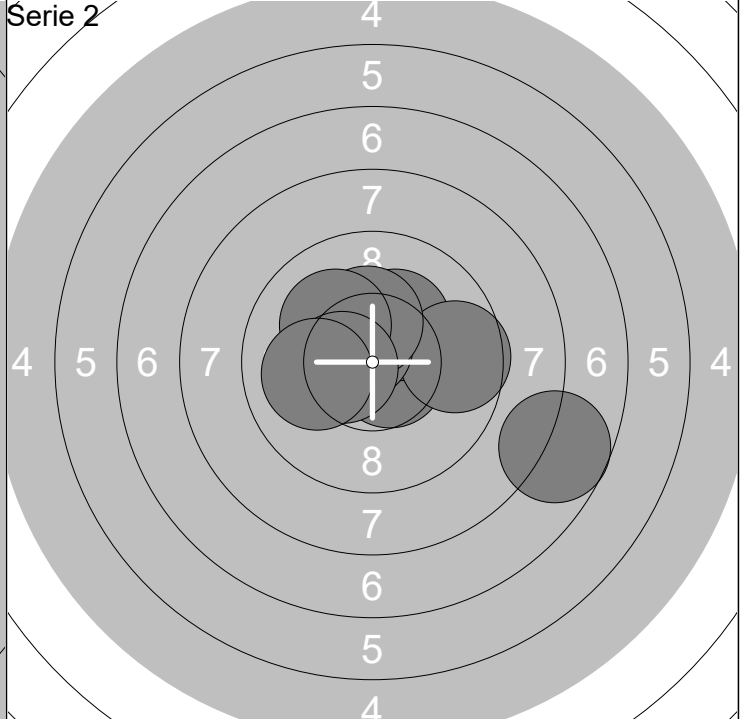
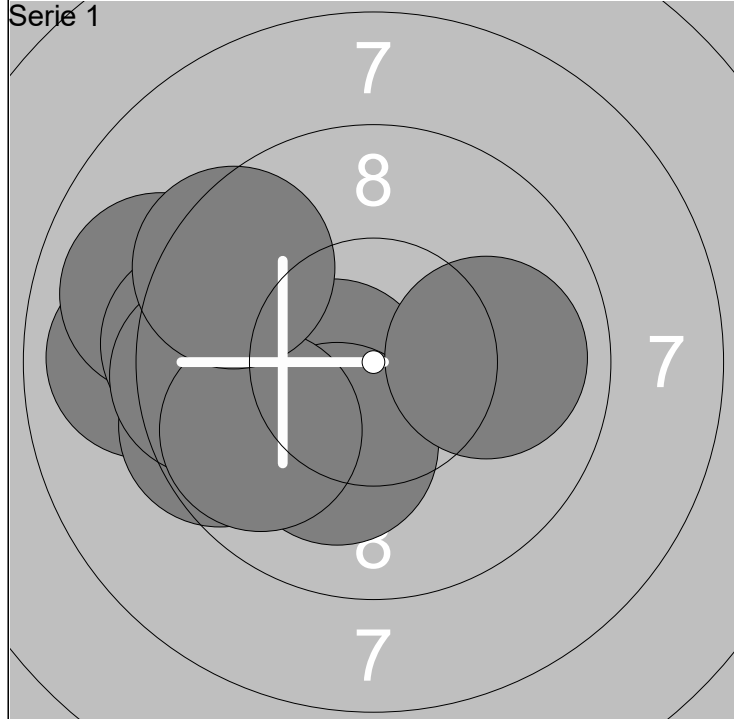

1: 10.6x ↙	6: 10.0 →	Serie	96.4
2: 9.0 ←	7: 9.4 ←		
3: 10.2x ↘	8: 9.5 ←	Total	96.4
4: 9.5 ←	9: 9.8 ↙		
5: 9.0 ←	10: 9.4 ↙		

11: 10.4x ↗	16: 10.3x ↑	Serie	100.0
12: 10.6x ↘	17: 7.7 ↘		
13: 10.2x ↗	18: 10.1 ↗	Total	196.4
14: 9.6 →	19: 10.5x ←		
15: 10.6x ↖	20: 10.0 ←		

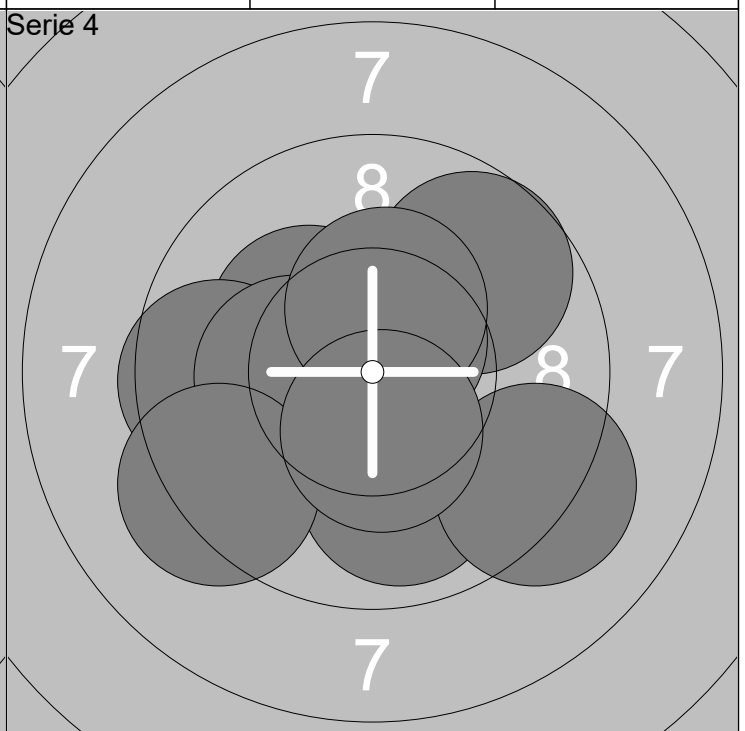
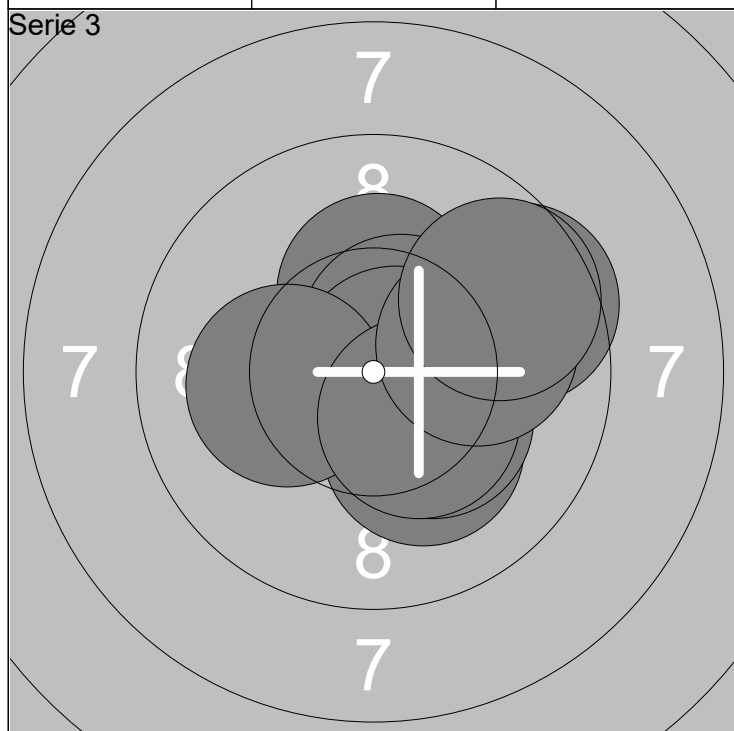

21: 10.3x ↑	26: 10.7x →	Serie	101.9
22: 10.2x ↘	27: 10.2x ←		
23: 10.3x ↘	28: 10.4x ↘	Total	298.3
24: 10.6x ↗	29: 10.0 →		
25: 9.5 ↗	30: 9.7 ↗		

31: 9.7 ↗	36: 9.2 ↘	Serie	99.7
32: 10.3x ↖	37: 10.3x ←		
33: 10.6x ↗	38: 9.3 ↙	Total	398.0
34: 9.9 ↘	39: 10.4x ↑		
35: 9.6 ←	40: 10.4x ↘		

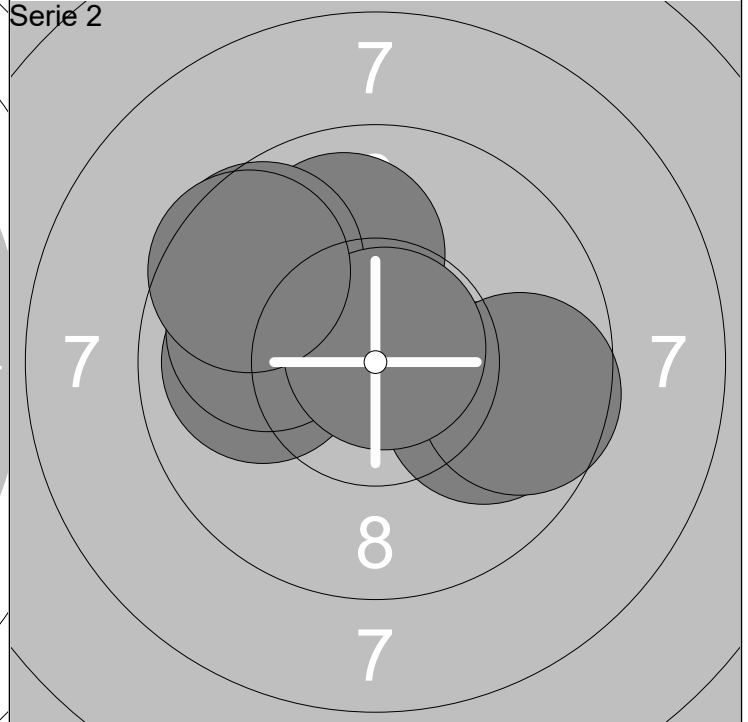
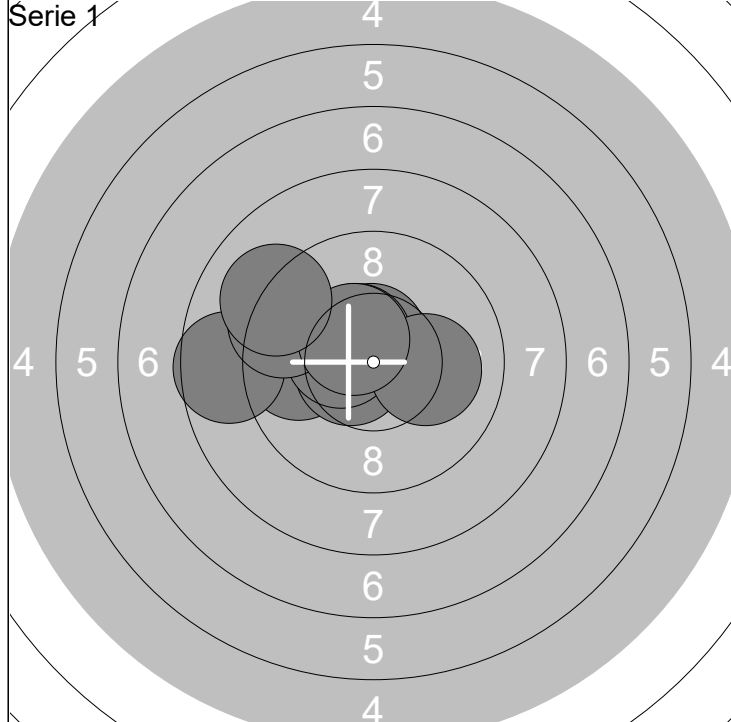

1: 9.7 ←	6: 10.4x ↙	Serie	99.5
2: 10.6x ↑	7: 9.4 ↙		
3: 10.5x ↗	8: 10.1 →	Total	99.5
4: 10.6x ←	9: 10.5x ↗		
5: 8.6 ←	10: 9.1 ↙		

11: 10.6x ↗	16: 9.9 ←	Serie	100.2
12: 10.0 ↑	17: 10.0 ↙		
13: 10.2x ↙	18: 9.6 ↗	Total	199.7
14: 9.9 →	19: 10.8x ↗		
15: 9.6 →	20: 9.6 ↙		

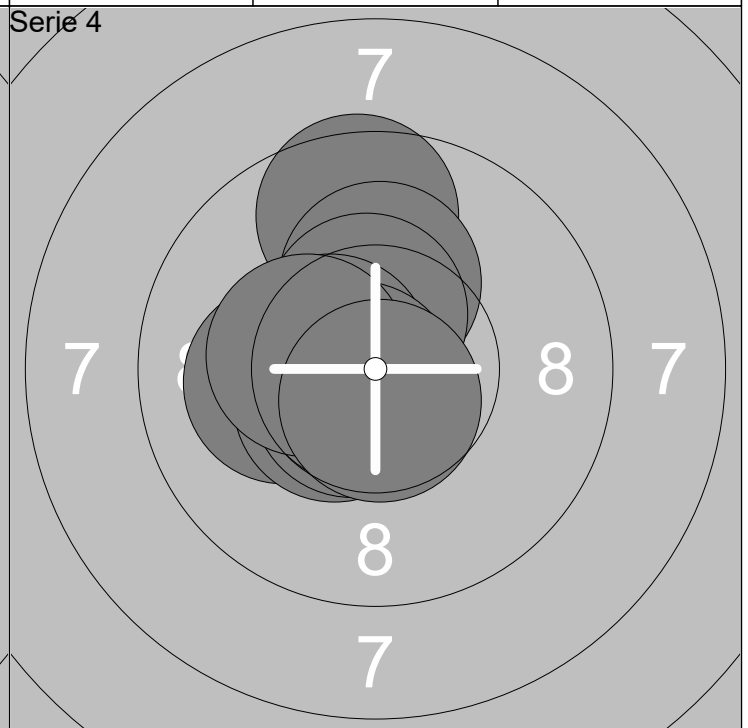
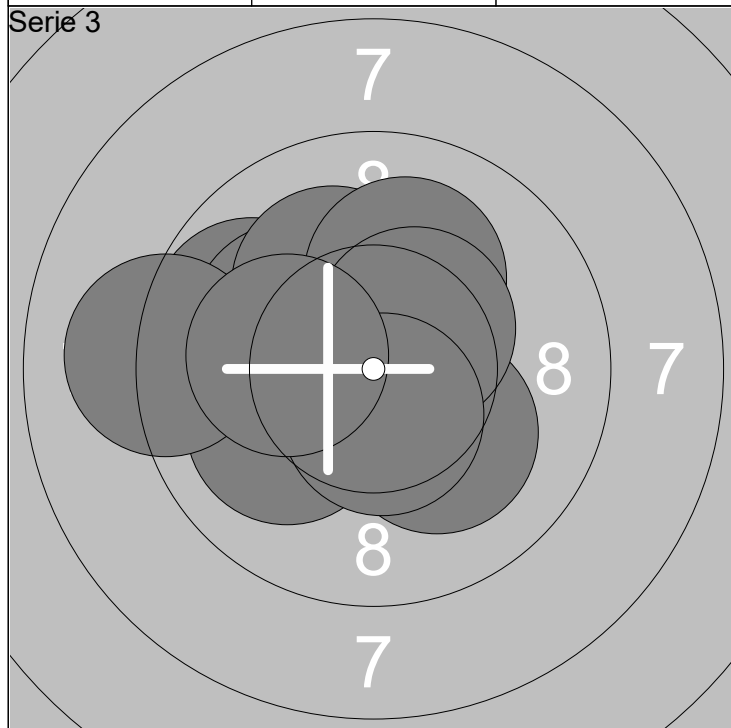

21: 9.8 ↙	26: 10.1 ↙	Serie	100.7
22: 10.1 ↙	27: 9.1 ↙		
23: 10.2x ↘	28: 10.4x ↗	Total	300.4
24: 10.1 ↗	29: 10.6x ↓		
25: 10.1 ↑	30: 10.2x ↙		

31: 9.6 ↑	36: 10.6x ↘	Serie	103.8
32: 10.2x ↑	37: 10.6x ↙		
33: 10.5x ↑	38: 10.7x ↙	Total	404.2
34: 10.1 ↙	39: 10.4x ↙		
35: 10.5x ↙	40: 10.6x ↓		

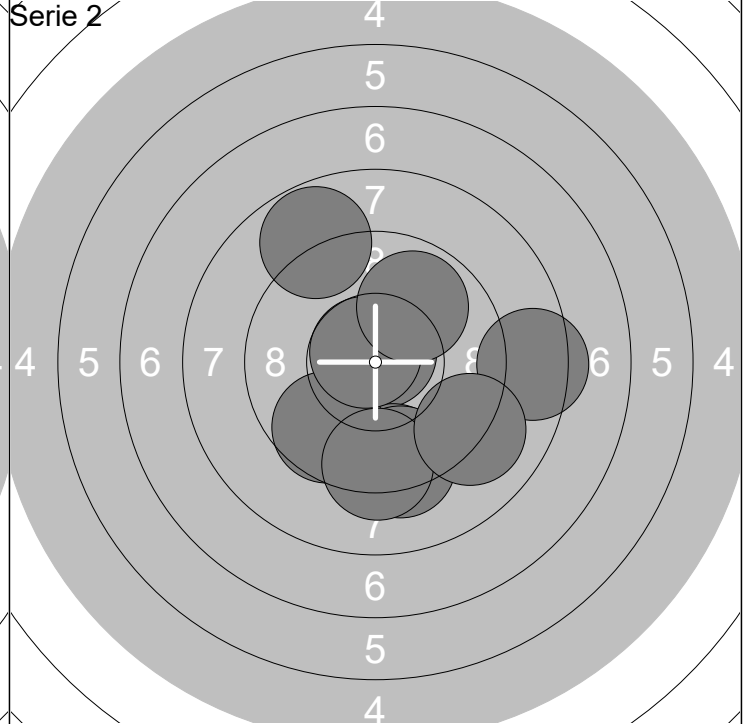
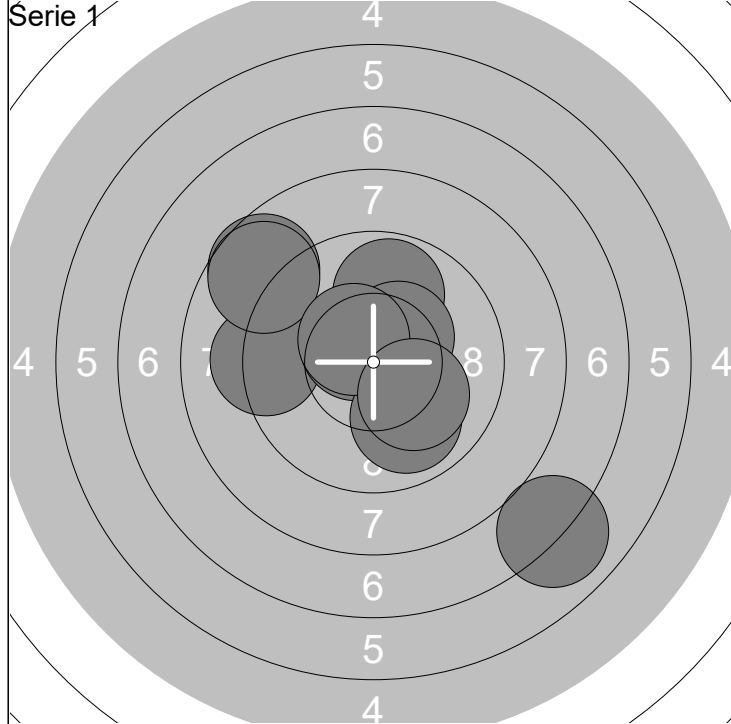

1: 9.2 ←	6: 9.9 ↓	Serie	94.8
2: 10.5x ↗	7: 8.7 ↗		
3: 8.7 ↗	8: 10.4x ↗	Total	94.8
4: 7.0 ↓	9: 10.5x ↗		
5: 9.8 ↑	10: 10.1 ↓		

11: 10.8x ↗	16: 8.8 ↗	Serie	95.4
12: 9.4 ↓	17: 9.3 ↓		
13: 9.7 ↙	18: 8.4 →	Total	190.2
14: 10.7x ↖	19: 9.1 ↘		
15: 9.3 ↓	20: 9.9 ↗		

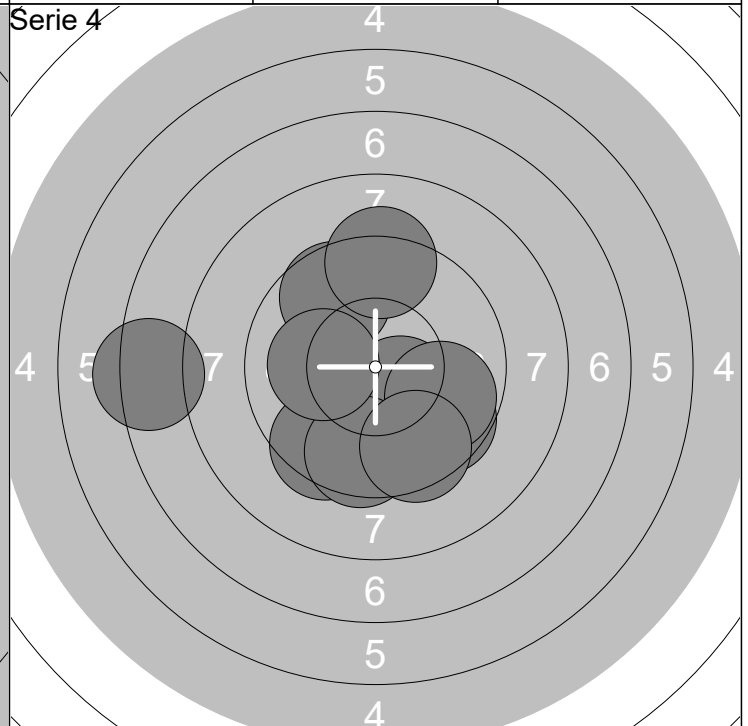
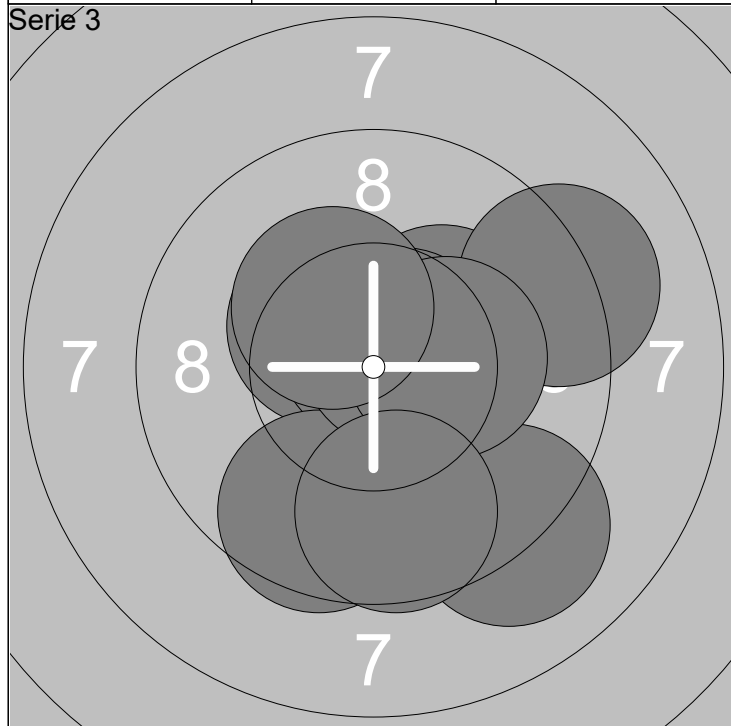

21: 9.1 ↘	26: 9.6 ↓	Serie	100.2
22: 10.4x ↖	27: 10.7x ↗		
23: 10.2x ↗	28: 10.3x →	Total	290.4
24: 10.8x ↑	29: 9.7 ↓		
25: 9.1 →	30: 10.3x ↗		

31: 10.4x ↘	36: 9.8 →	Serie	94.8
32: 9.5 ↓	37: 9.6 ↓		
33: 7.3 ←	38: 10.1 ←	Total	385.2
34: 9.7 ↗	39: 9.3 ↑		
35: 9.6 ↓	40: 9.5 ↓		



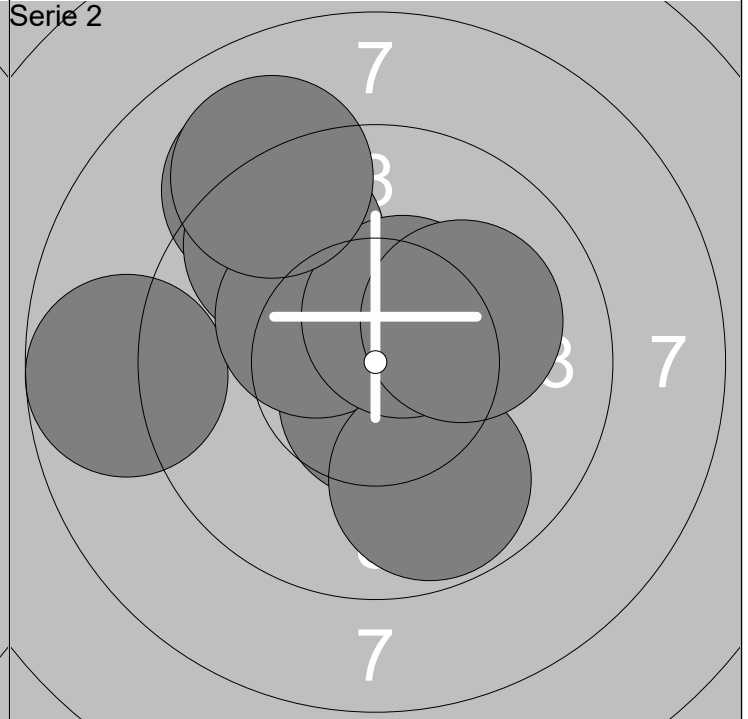
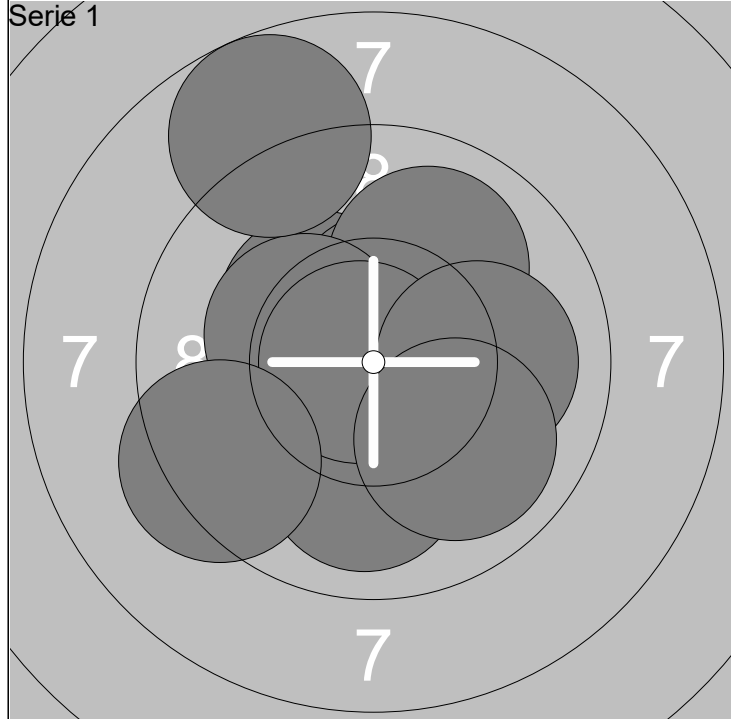

1: 10.0 ↓	6: 10.8x ←	Serie	100.0
2: 10.3x ↗	7: 10.1 →		
3: 10.5x ↑	8: 9.3 ←	Total	100.0
4: 10.0 ↗	9: 8.7 ↗		
5: 10.3x ↖	10: 10.0 ↓		

11: 10.5x ↗	16: 10.3x ↖	Serie	98.4
12: 10.6x ↓	17: 9.8 ↓		
13: 8.8 ←	18: 10.5x ↑	Total	198.4
14: 9.1 ↗	19: 10.1 ↗		
15: 9.6 ↖	20: 9.1 ↗		

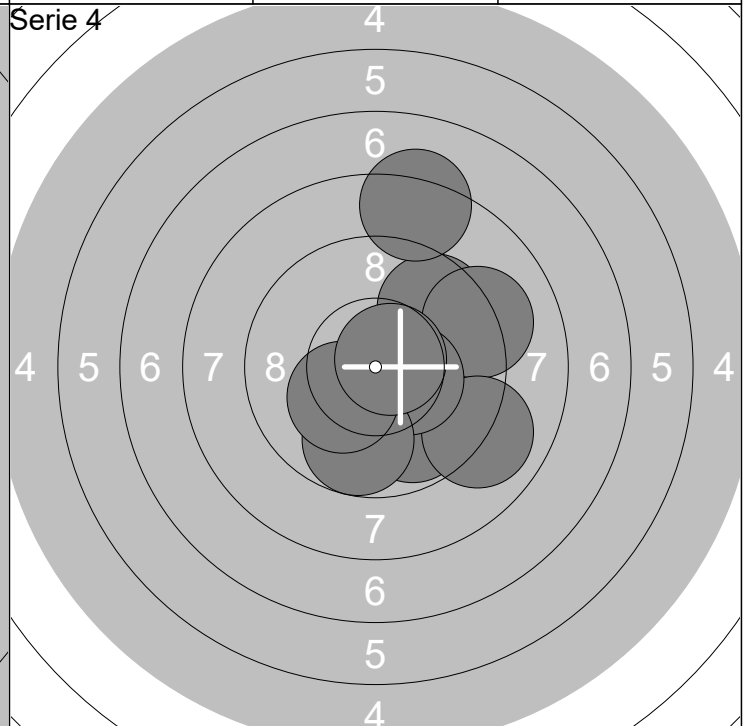
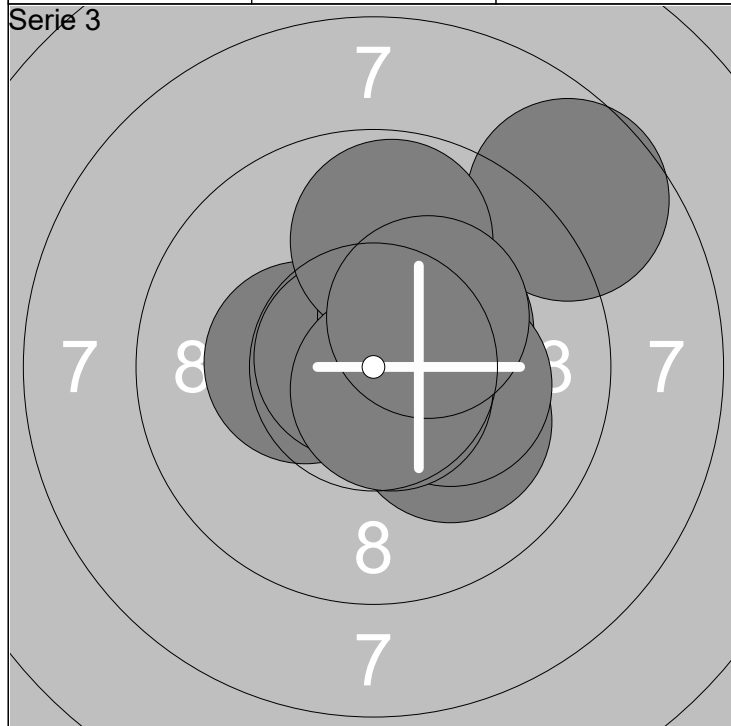

21: 10.4x ←	26: 10.4x ↗	Serie	101.8
22: 10.1 ↓	27: 9.8 ↑		
23: 8.7 ↗	28: 10.2x →	Total	300.2
24: 10.8x ↖	29: 10.7x ↓		
25: 10.4x ↗	30: 10.3x ↗		

31: 10.4x →	36: 10.4x →	Serie	97.4
32: 9.6 ↗	37: 9.8 ↓		
33: 9.2 ↗	38: 10.2x ↖	Total	397.6
34: 9.8 ↓	39: 8.3 ↑		
35: 9.0 ↓	40: 10.7x ↗		

Skjutlag  
**4**

Tavla  
**9**

**Johanna Andersson**

Rottne Industri Cup 2019

Nässjö Skyttegille

L17

26.10.2019

Rottne Industri Cup 2019

Söraby SKF

Serie 1

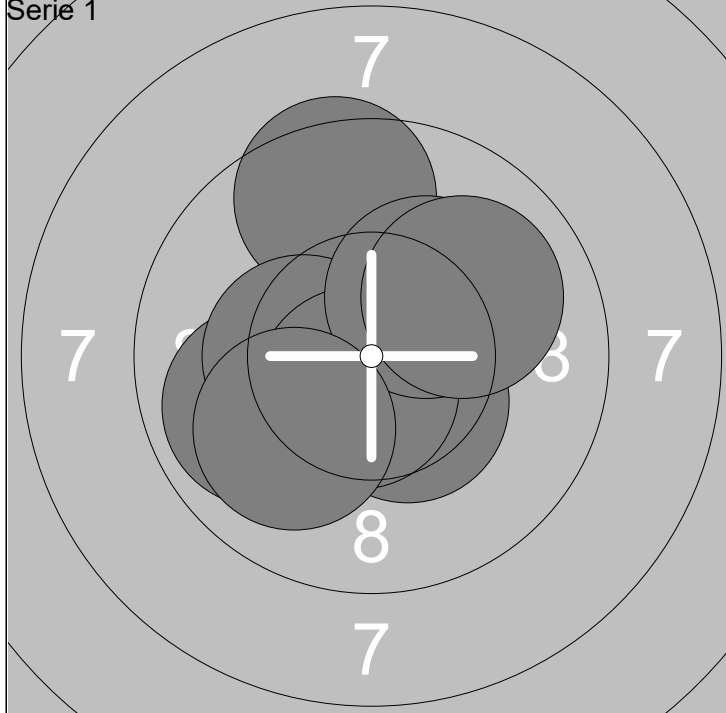

Serie 2

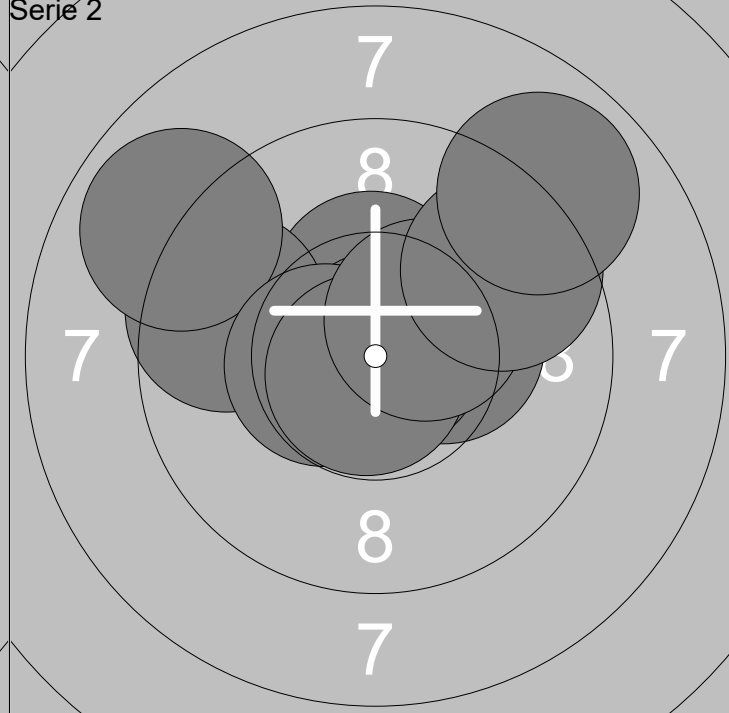

1: 10.5x ↗	6: 10.4x ←
2: 10.6x ↖	7: 10.6x ↓
3: 9.5 ↗	8: 10.2x ↗
4: 9.9 ←	9: 10.0 ↗
5: 10.4x ↓	10: 10.0 ↘

Serie	102.1
Total	102.1

11: 10.4x ↗	16: 10.5x ←
12: 10.4x →	17: 10.8x ↓
13: 9.6 ←	18: 10.4x ↗
14: 10.9x ↗	19: 9.6 ↗
15: 8.9 ↖	20: 8.9 ↗

Serie	100.4
Total	202.5

Serie 3

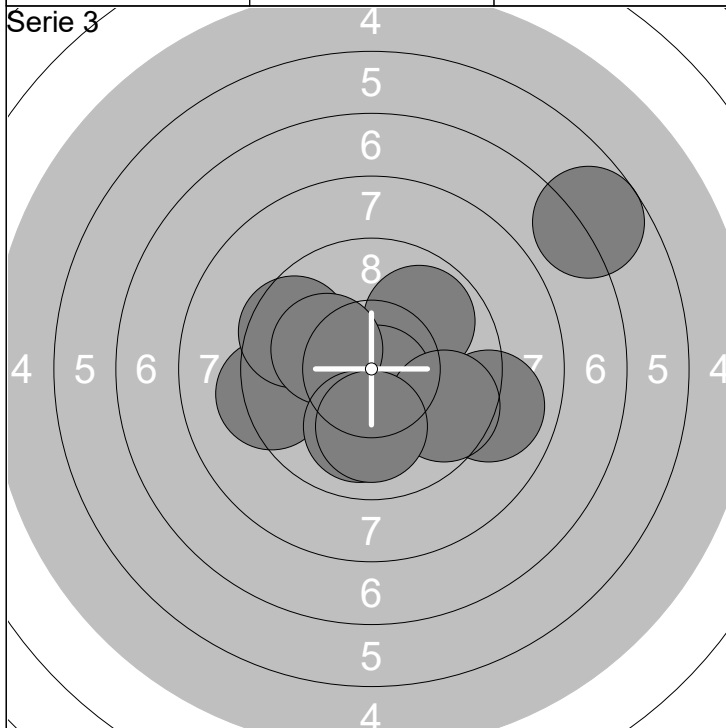

Serie 4

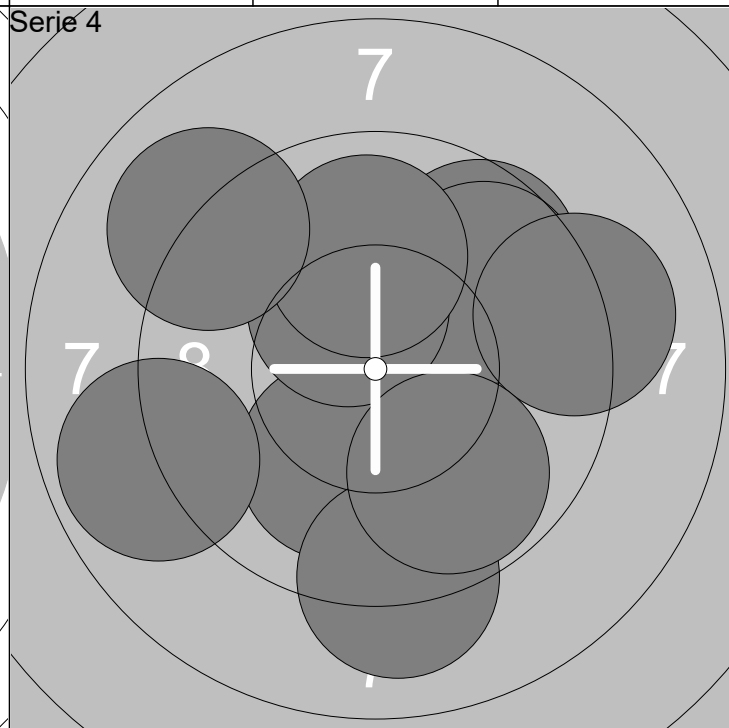

21: 9.3 ←	26: 10.0 ↓
22: 9.6 ↖	27: 6.7 ↗
23: 9.9 ↗	28: 9.0 →
24: 10.7x ↓	29: 9.6 →
25: 10.1 ↖	30: 10.0 ↓

Serie	94.9
Total	297.4

31: 9.6 ↗	36: 9.9 ↗
32: 9.7 ↗	37: 8.9 ←
33: 10.1 ↓	38: 9.1 ↓
34: 9.1 →	39: 9.8 ↓
35: 10.3x ↗	40: 9.0 ↗

Serie	95.5
Total	392.9

Rottne Industri Cup 2019

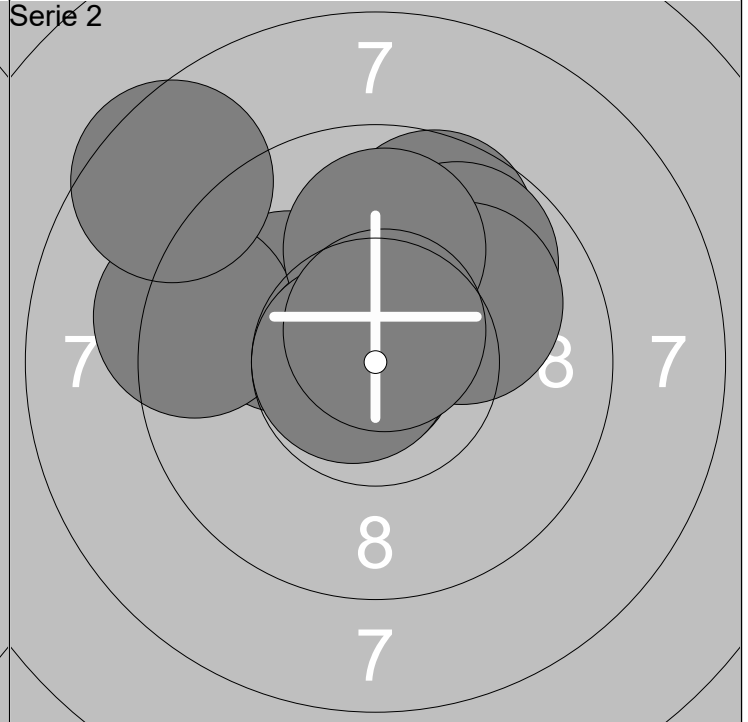
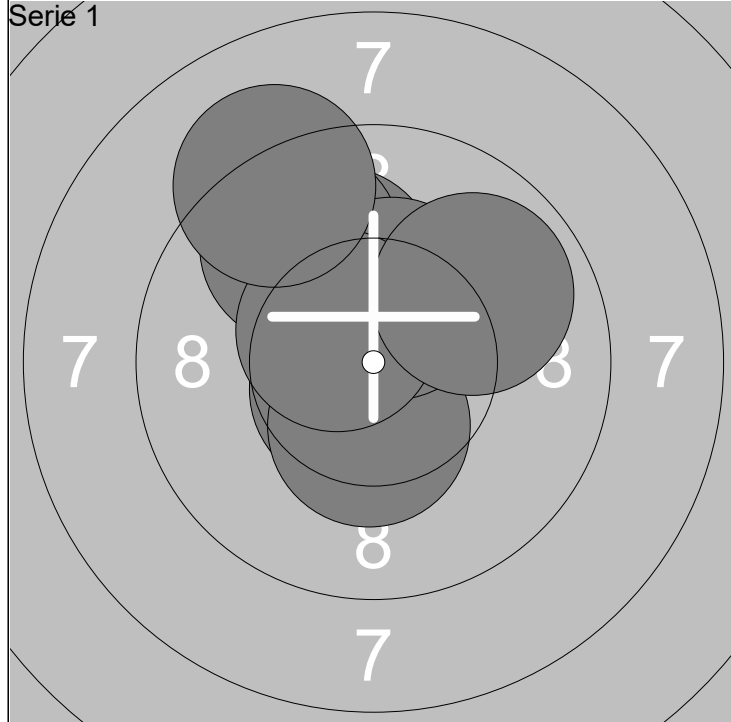

1: 10.6x ↑	6: 10.4x ↓	Serie 102.3
2: 10.1 ↑	7: 10.4x ↑	
3: 10.9x ↖	8: 10.5x ↗	Total 102.3
4: 9.7 ↗	9: 9.2 ↗	
5: 10.6x ↙	10: 9.9 ↗	

11: 9.7 ↑	16: 10.0 ↗	Serie 99.5
12: 10.1 ↖	17: 10.8x ←	
13: 9.3 ←	18: 9.9 ↑	Total 201.8
14: 9.8 ↗	19: 10.7x ←	
15: 8.5 ↖	20: 10.7x ↑	

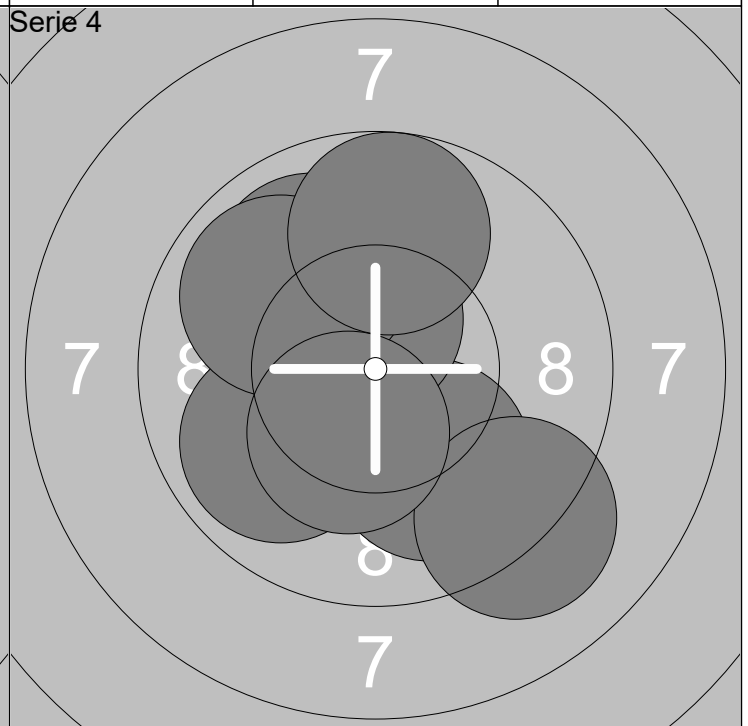
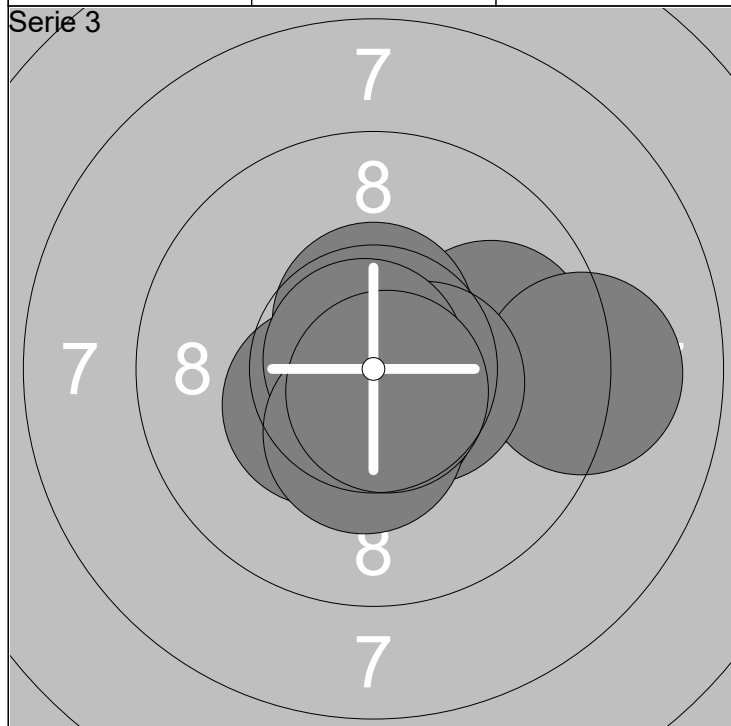

21: 10.7x →	26: 10.5x →	Serie 103.6
22: 9.9 →	27: 10.6x ↓	
23: 10.5x ↑	28: 10.8x ↗	Total 305.4
24: 9.1 →	29: 10.4x ↓	
25: 10.4x ↙	30: 10.7x ↓	

31: 10.0 ↓	36: 9.9 ←	Serie 100.0
32: 10.2x ↗	37: 9.9 ↖	
33: 10.3x ↗	38: 9.1 ↓	Total 405.4
34: 10.5x ↑	39: 10.4x ↓	
35: 9.9 ↗	40: 9.8 ↑	

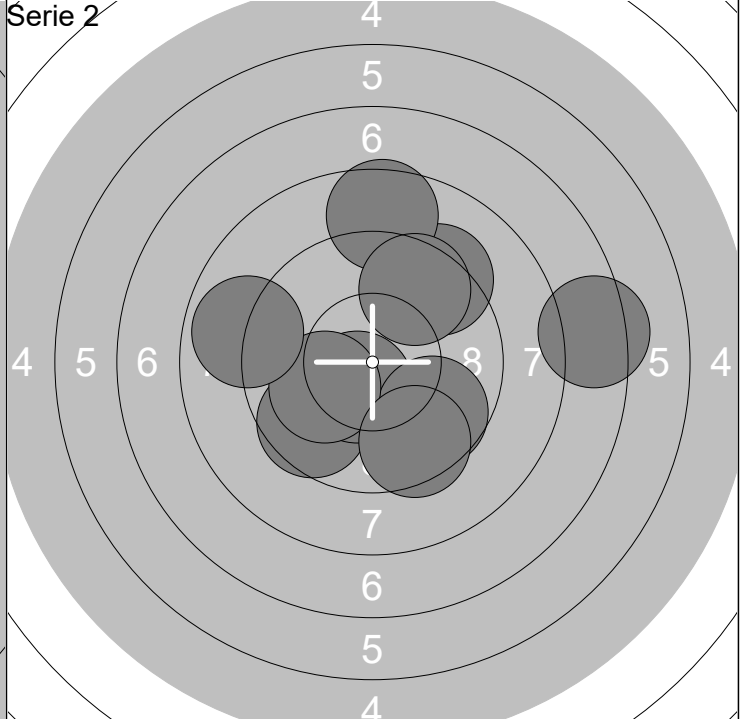
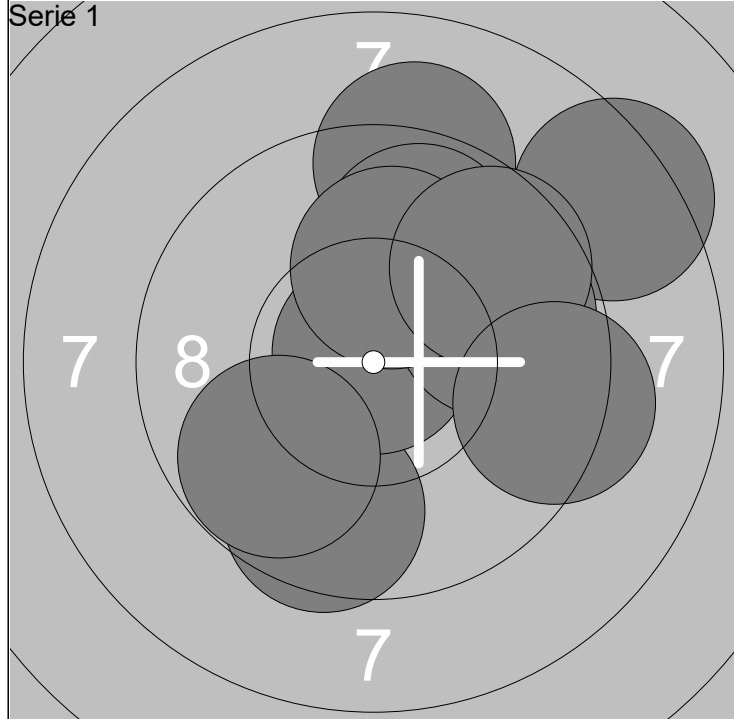

1: 9.6 ↓	6: 9.8 ↑	Serie	96.5
2: 9.2 ↑	7: 10.1 ↑		
3: 10.9x ↑	8: 9.8 ↙	Total	96.5
4: 8.4 ↗	9: 9.6 ↗		
5: 9.8 →	10: 9.3 →		

11: 9.3 ↗	16: 9.7 ↘	Serie	93.2
12: 8.6 ↑	17: 7.4 →		
13: 9.6 ↗	18: 10.1 ←	Total	189.7
14: 9.6 ↙	19: 8.9 ←		
15: 10.5x ↘	20: 9.5 ↘		

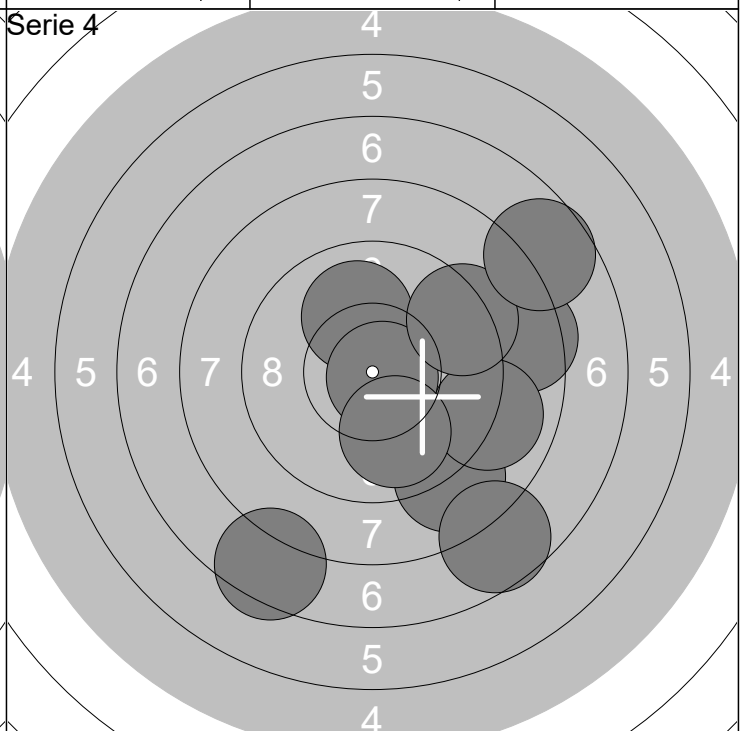
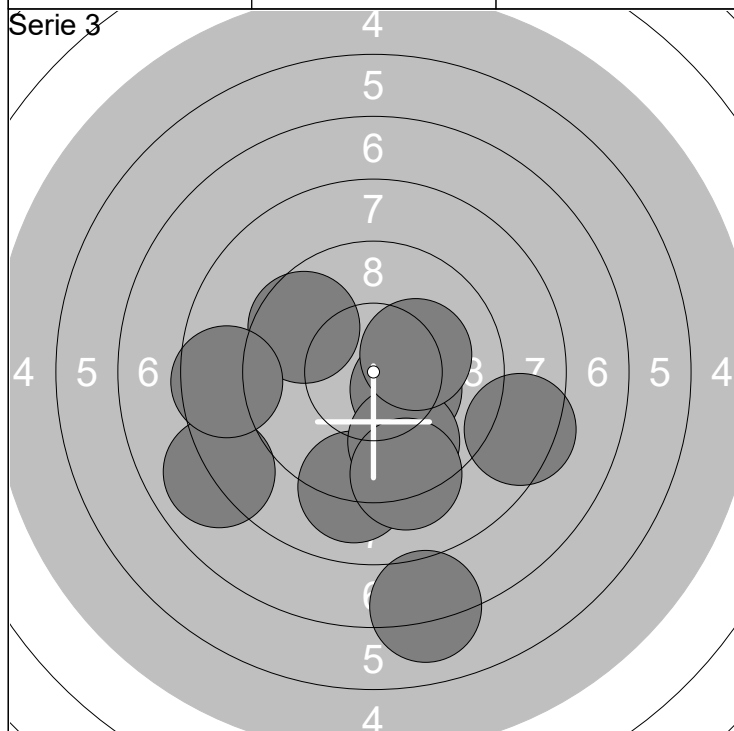

21: 9.1 ↓	26: 10.2x →	Serie	90.4
22: 8.0 ↙	27: 7.1 ↓		
23: 10.4x →	28: 8.6 ←	Total	280.1
24: 9.8 ↓	29: 8.4 →		
25: 9.6 ↗	30: 9.2 ↓		

31: 8.9 ↘	36: 7.5 ↓	Serie	89.3
32: 8.5 →	37: 10.8x →		
33: 9.0 →	38: 9.9 ↓	Total	369.4
34: 7.7 ↘	39: 9.3 ↗		
35: 10.0 ↑	40: 7.7 ↗		

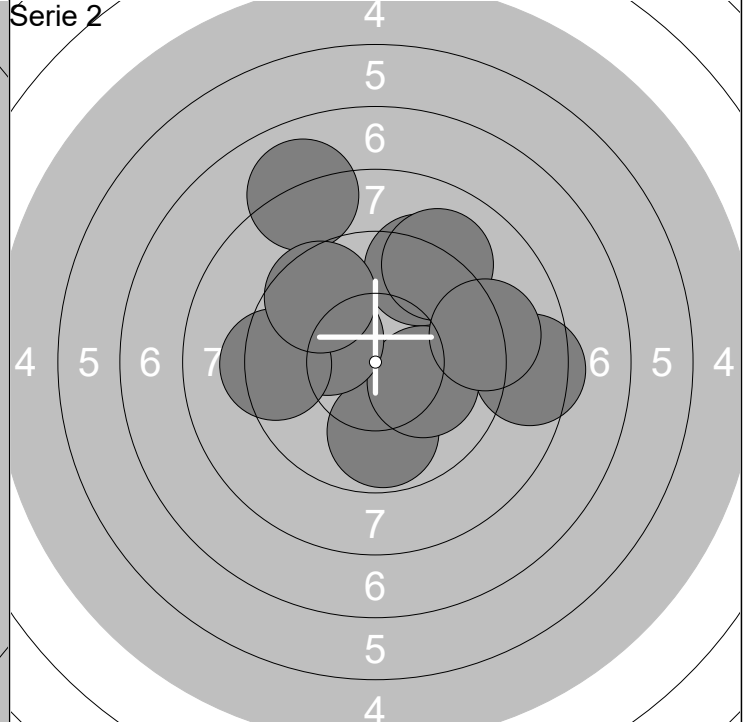
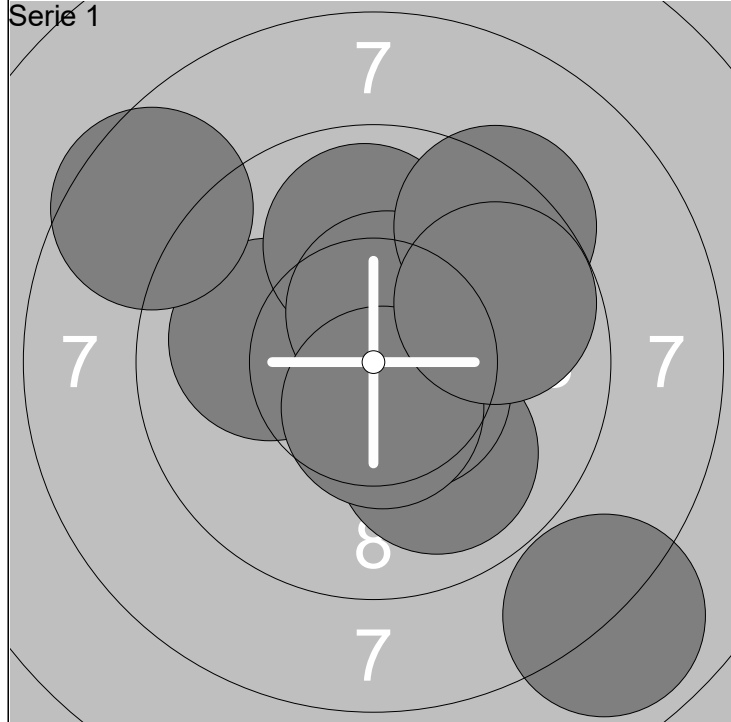

1: 10.0 ←	6: 7.9 ↘	Serie	97.1
2: 10.0 ↘	7: 10.5x ↑		
3: 10.5x ↘	8: 9.3 ↗	Total	97.1
4: 8.6 ↗	9: 10.6x ↓		
5: 9.9 ↑	10: 9.8 ↗		

11: 9.8 ↓	16: 10.1 ←	Serie	93.0
12: 8.5 →	17: 9.4 ←		
13: 9.3 ↗	18: 9.1 ↗	Total	190.1
14: 8.0 ↗	19: 9.6 ↗		
15: 10.1 →	20: 9.1 →		

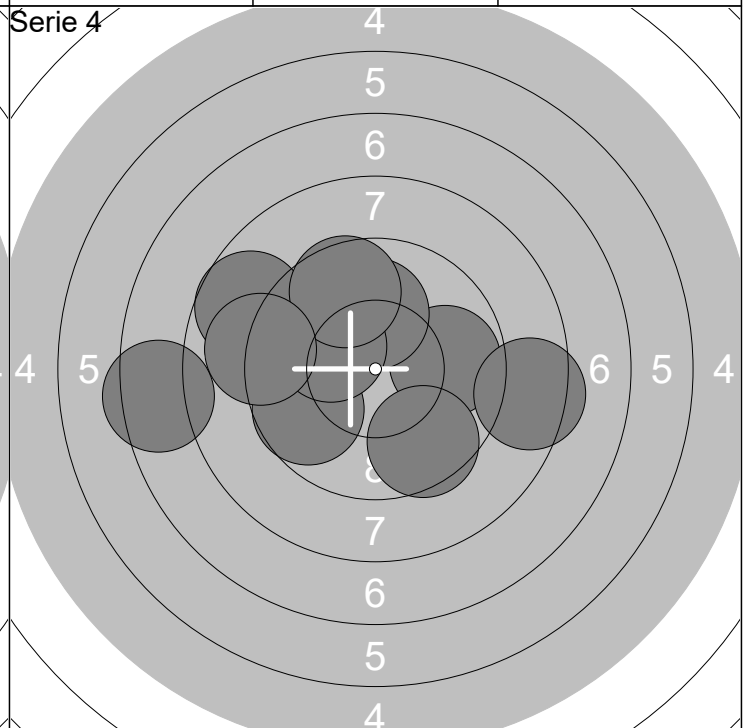
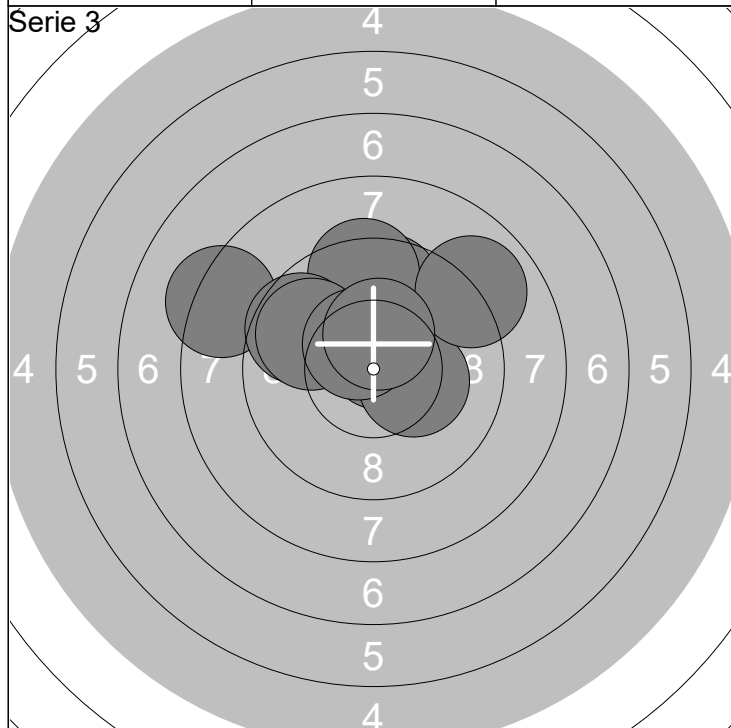

21: 10.7x ↗	26: 9.0 ↗	Serie	97.7
22: 8.3 ←	27: 9.6 ←		
23: 9.7 ↑	28: 9.8 ←	Total	287.8
24: 9.4 ↑	29: 10.5x ↗		
25: 10.3x →	30: 10.4x ↑		

31: 9.7 ←	36: 8.7 ←	Serie	92.6
32: 9.8 →	37: 10.2x ←		
33: 8.4 →	38: 7.4 ←	Total	380.4
34: 10.1 ↑	39: 9.6 ↗		
35: 9.6 ↓	40: 9.1 ←		

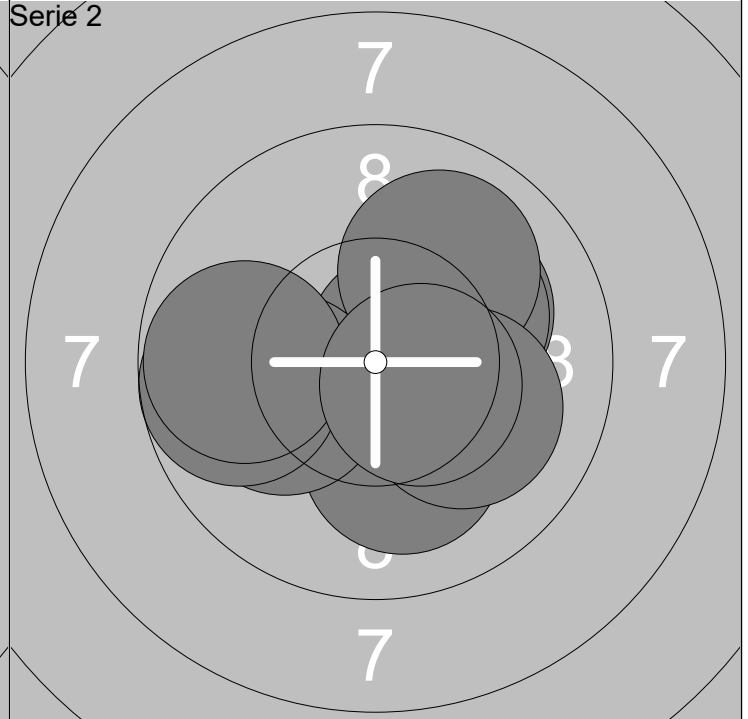
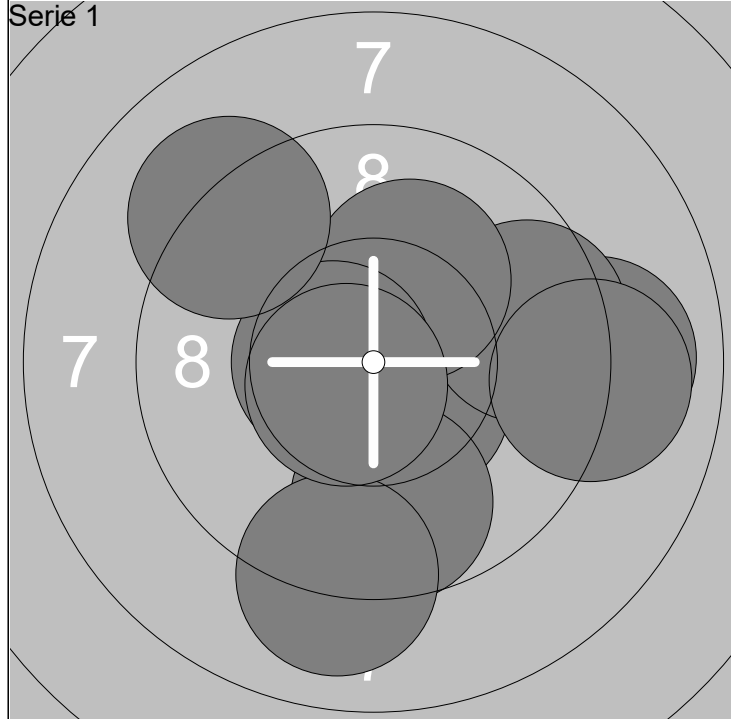

1: 10.5x ↘	6: 9.0 ↓	Serie 97.4
2: 9.0 →	7: 10.6x ←	
3: 9.7 ↓	8: 10.6x ↙	Total 97.4
4: 9.6 →	9: 9.0 →	
5: 10.2x ↗	10: 9.2 ↖	

11: 10.2x ↗	16: 10.1 ←	Serie 101.3
12: 10.2x ↗	17: 9.7 ←	
13: 10.6x ↗	18: 10.1 ↘	Total 198.7
14: 10.0 ↗	19: 9.8 ←	
15: 10.1 ↓	20: 10.5x ↘	

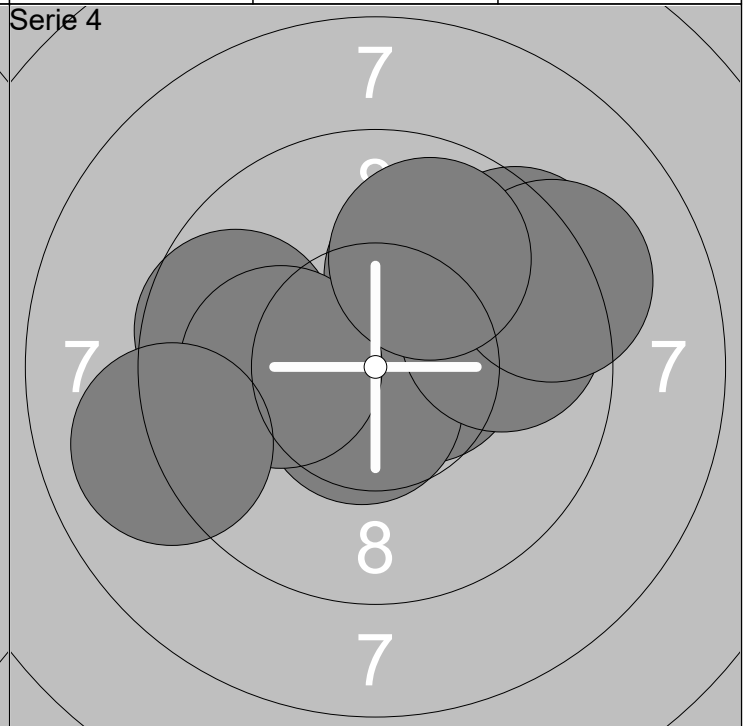
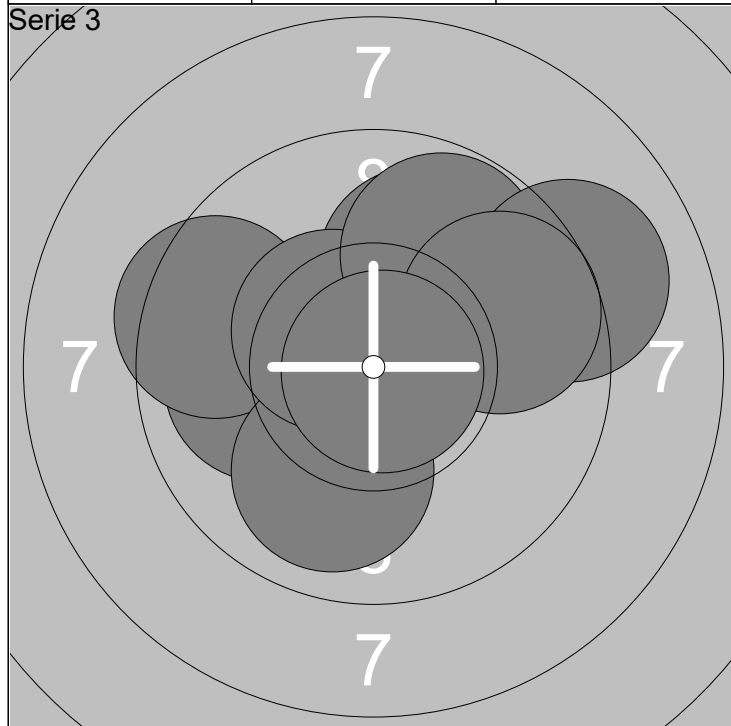

21: 10.0 ←	26: 10.4x ↖	Serie 99.9
22: 9.5 ←	27: 9.8 ↗	
23: 10.0 ↗	28: 9.1 →	Total 298.6
24: 10.0 ↓	29: 9.7 →	
25: 10.6x ↗	30: 10.8x ↘	

31: 10.0 ↗	36: 10.1 ←	Serie 98.2
32: 9.4 ↗	37: 9.0 ←	
33: 9.7 ←	38: 9.8 →	Total 396.8
34: 10.5x →	39: 9.2 ↗	
35: 10.6x ↓	40: 9.9 ↗	

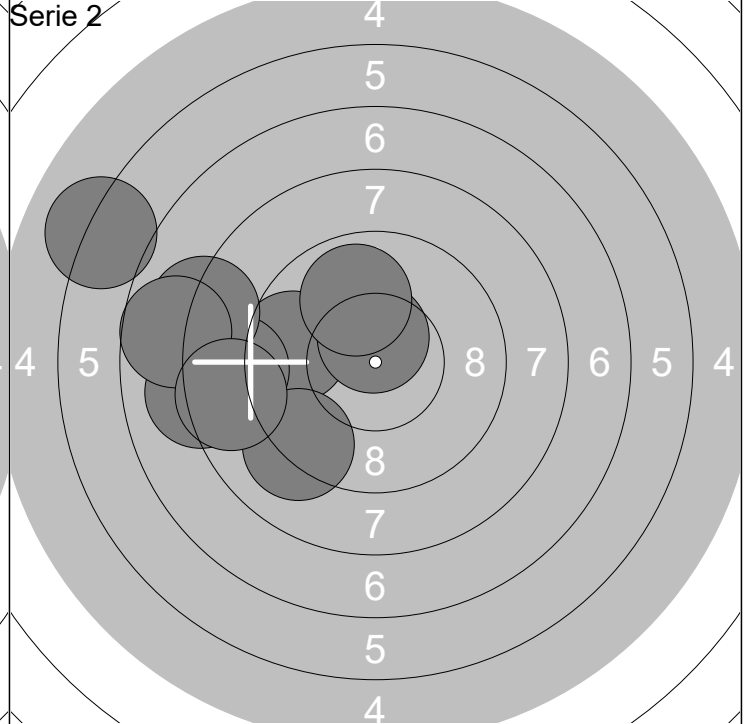
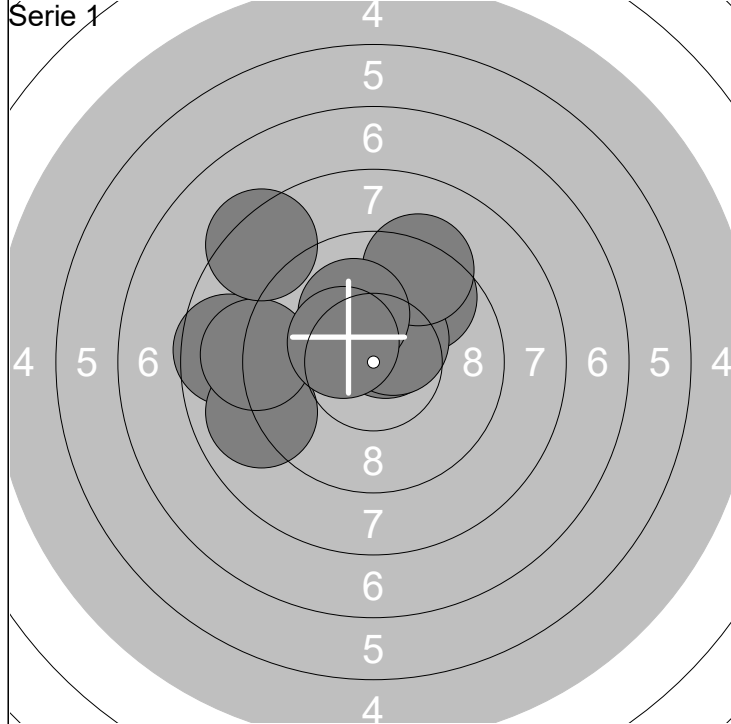

1: 9.7 ↗	6: 9.0 ←	Serie 95.7
2: 10.6x ↗	7: 10.1 ↗	
3: 10.5x ↗	8: 9.1 ←	Total 95.7
4: 9.3 ↗	9: 8.4 ↗	
5: 8.6 ←	10: 10.4x ↖	

11: 9.6 ←	16: 7.7 ←	Serie 86.5
12: 8.7 ←	17: 9.9 ↗	
13: 10.5x ↑	18: 9.2 ↘	Total 182.2
14: 8.1 ←	19: 6.1 ←	
15: 8.1 ←	20: 8.6 ←	

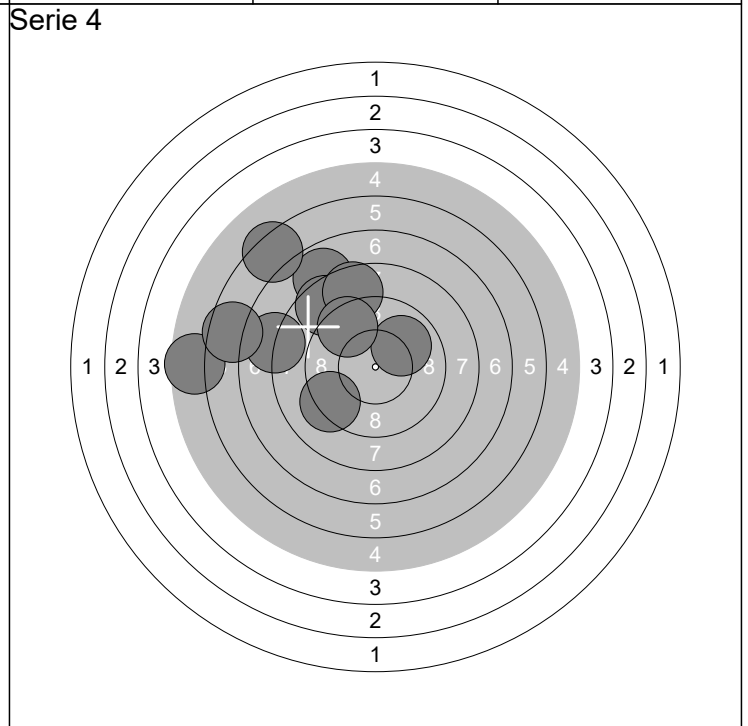
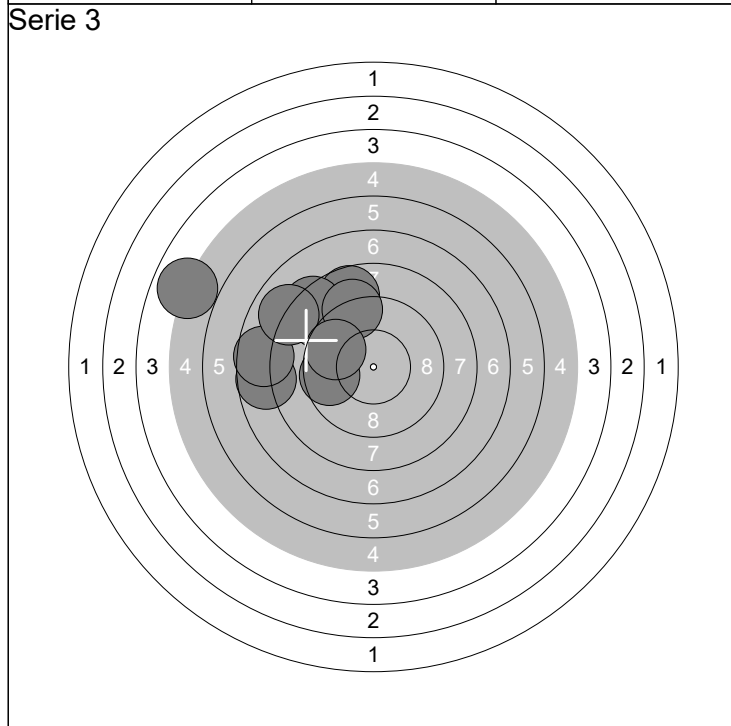

21: 8.7 ↗	26: 7.6 ←	Serie 82.5
22: 8.8 ↗	27: 8.0 ↖	
23: 8.4 ↗	28: 9.6 ←	Total 264.7
24: 7.7 ←	29: 9.1 ↗	
25: 4.9 ←	30: 9.7 ↖	

31: 7.9 ↗	36: 5.5 ←	Serie 80.0
32: 10.0 ↗	37: 8.6 ↗	
33: 8.6 ↗	38: 9.5 ↗	Total 344.7
34: 7.9 ←	39: 9.2 ↘	
35: 6.3 ↗	40: 6.5 ←	

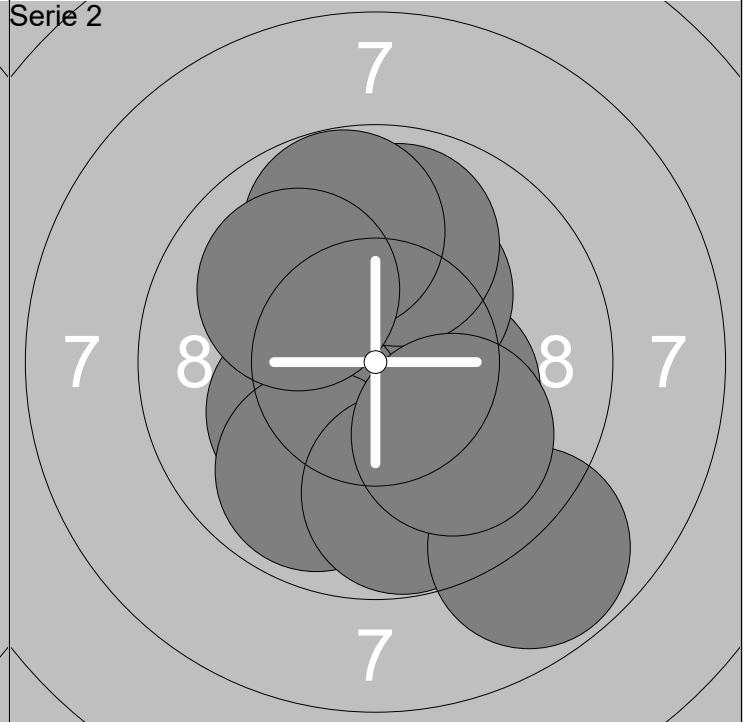
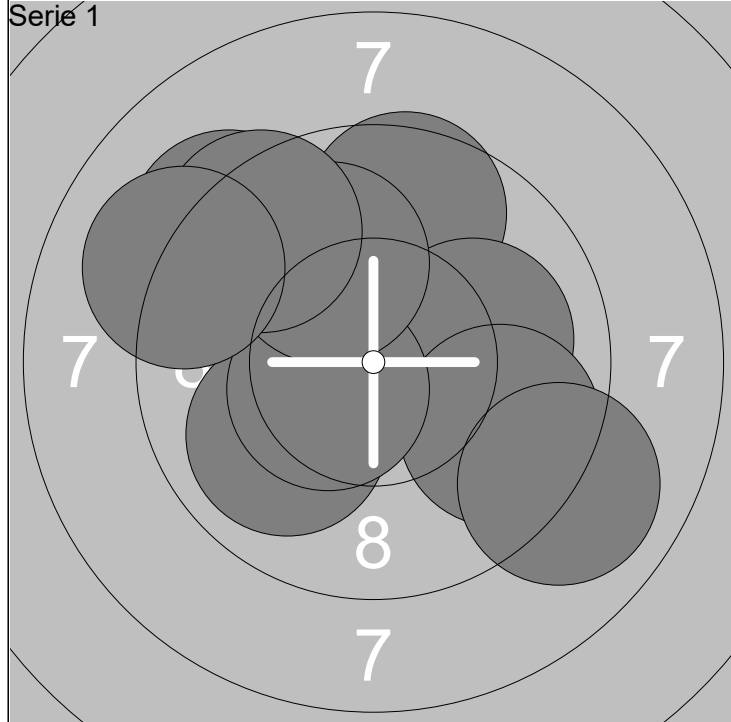

1: 9.6 ↑	6: 9.2 ↗	Serie	96.4
2: 10.0 →	7: 10.0 ↗		
3: 9.7 →	8: 9.0 ↘	Total	96.4
4: 9.9 ↙	9: 9.4 ↗		
5: 10.5x ↙	10: 9.1 ↖		

11: 10.3x →	16: 9.9 ↑	Serie	98.9
12: 10.3x ↗	17: 9.7 ↑		
13: 10.2x ↙	18: 8.8 ↘	Total	195.3
14: 9.9 ↙	19: 10.0 ↗		
15: 9.8 ↓	20: 10.0 ↘		

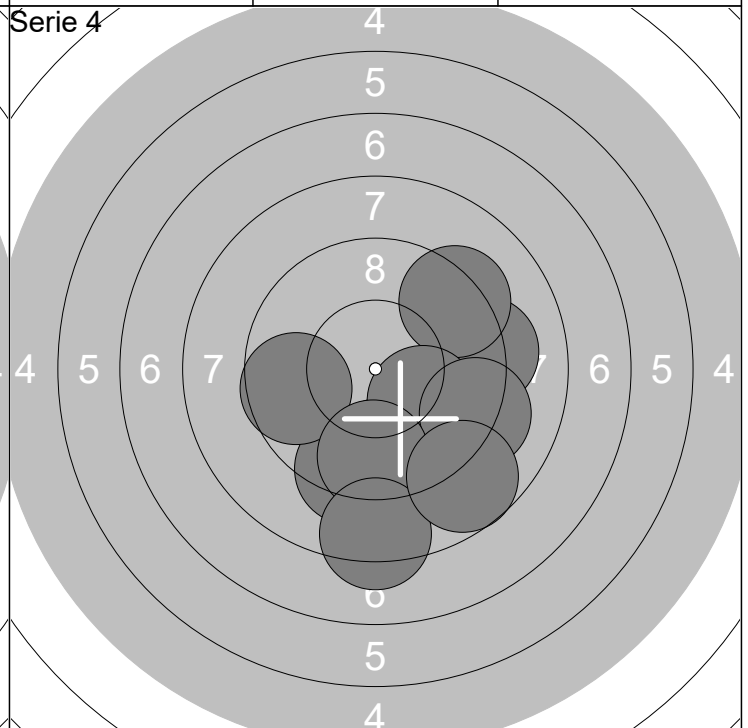
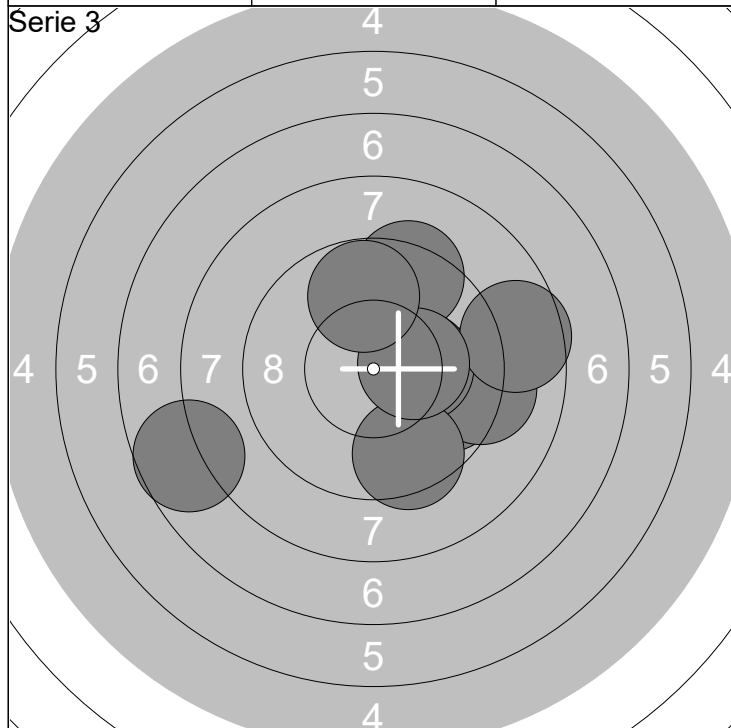

21: 9.7 →	26: 10.2x →	Serie	93.9
22: 9.4 ↑	27: 9.5 ↓		
23: 7.7 ↙	28: 8.6 →	Total	289.2
24: 9.5 →	29: 10.3x →		
25: 9.2 →	30: 9.8 ↑		

31: 9.2 →	36: 10.0 ↘	Serie	92.8
32: 9.3 ↓	37: 9.2 →		
33: 9.6 ↙	38: 9.6 ↓	Total	382.0
34: 9.6 ↓	39: 8.3 ↓		
35: 9.3 ↗	40: 8.7 ↘		



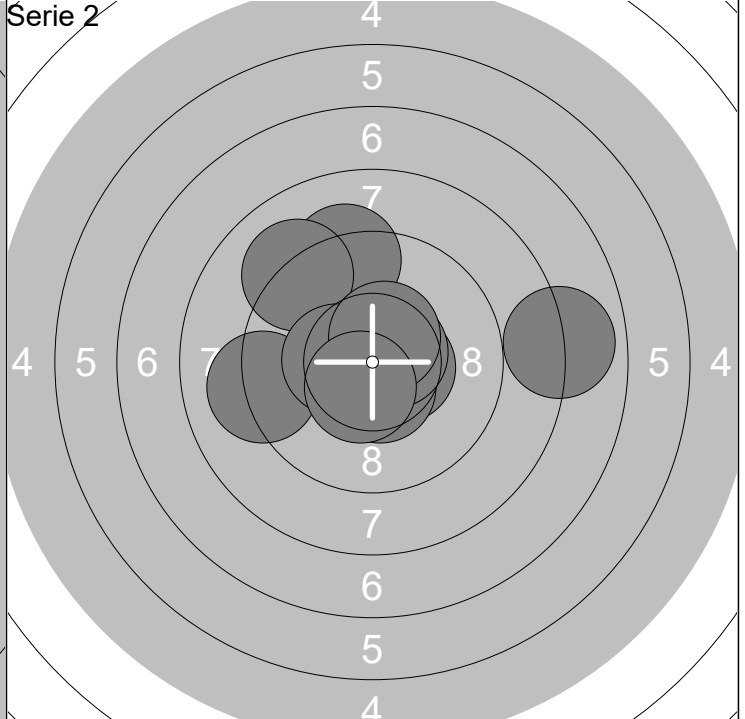
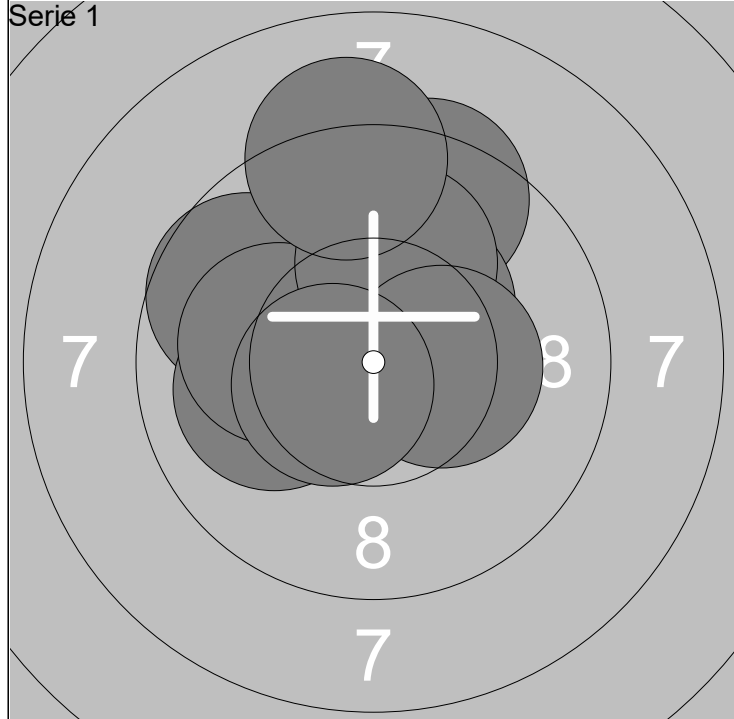

1: 9.9 ↖	6: 10.1 ←	Serie	99.5
2: 9.7 ↖	7: 10.1 ↑		
3: 9.4 ↑	8: 9.1 ↑	Total	99.5
4: 10.3x ↗	9: 10.4x →		
5: 10.0 ←	10: 10.5x ↙		

11: 7.9 →	16: 10.6x ↗	Serie	98.5
12: 9.3 ↑	17: 9.1 ↗		
13: 9.2 ←	18: 10.4x ←	Total	198.0
14: 10.5x →	19: 10.5x ↗		
15: 10.5x ↓	20: 10.5x ↓		

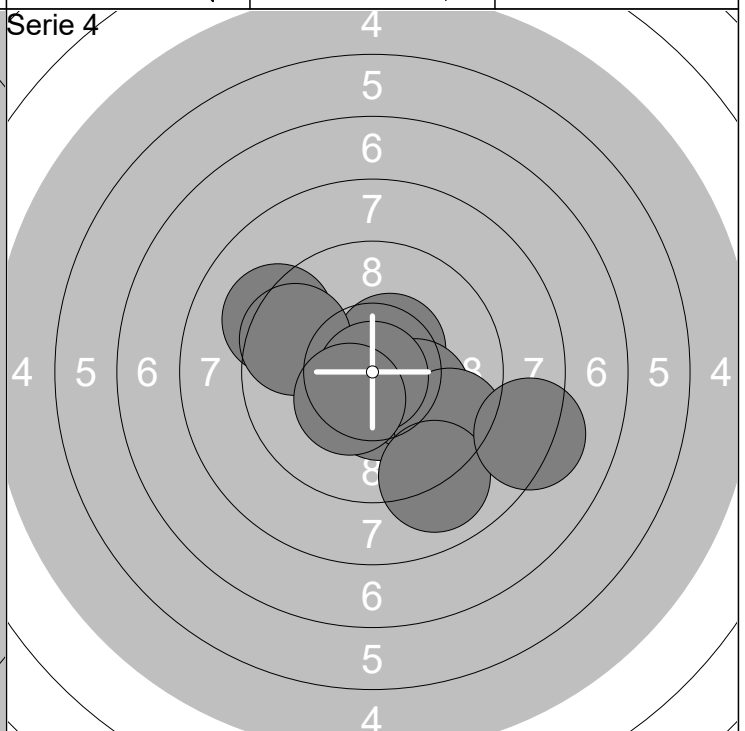
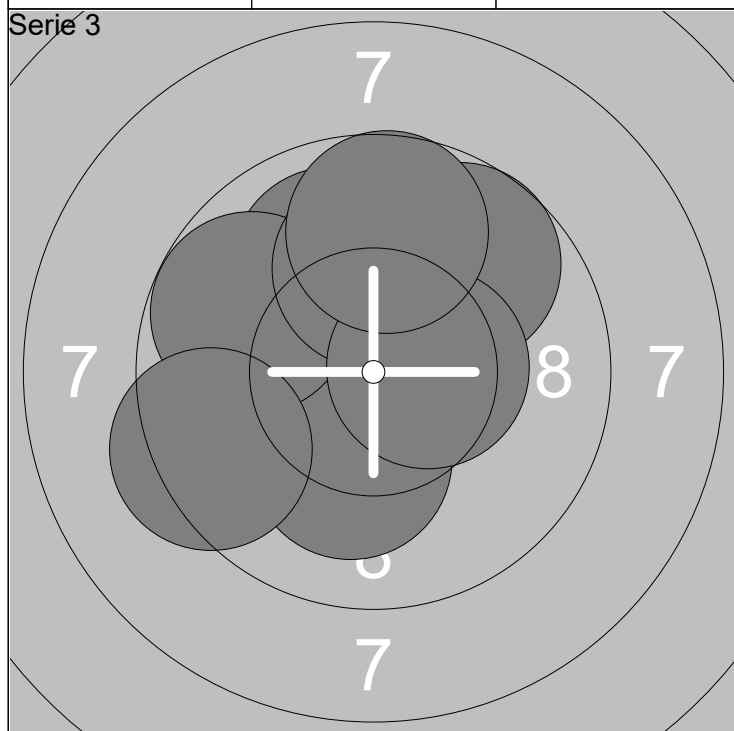

21: 10.0 ↑	26: 9.7 ↗	Serie	100.0
22: 10.7x ↓	27: 10.0 ↑		
23: 10.2x ↓	28: 10.5x →	Total	298.0
24: 10.0 ↑	29: 9.7 ↑		
25: 9.8 ↖	30: 9.4 ←		

31: 9.2 ↖	36: 9.0 ↓	Serie	97.9
32: 10.4x ↓	37: 9.6 ↖		
33: 10.5x ↗	38: 10.9x ↓	Total	395.9
34: 10.2x ↘	39: 8.2 →		
35: 9.5 ↘	40: 10.4x ↙		

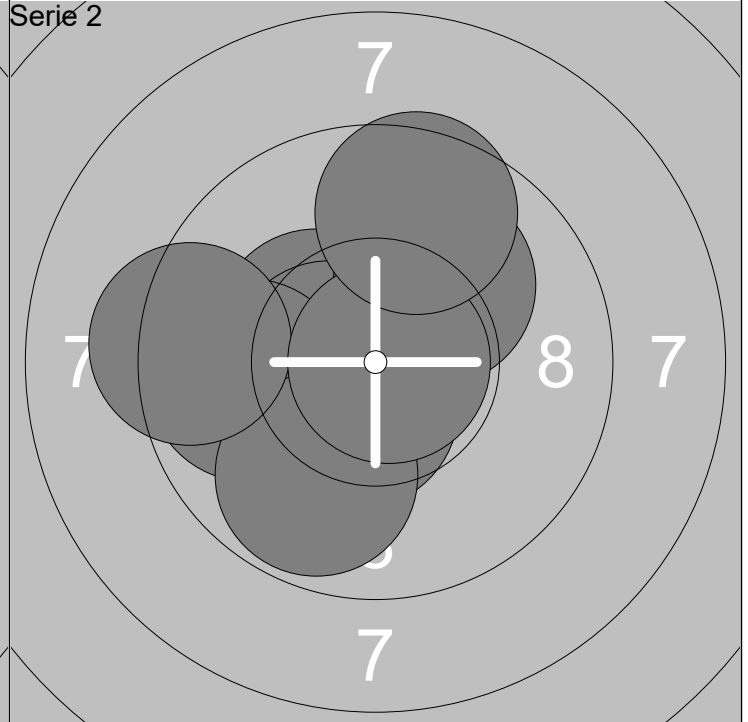
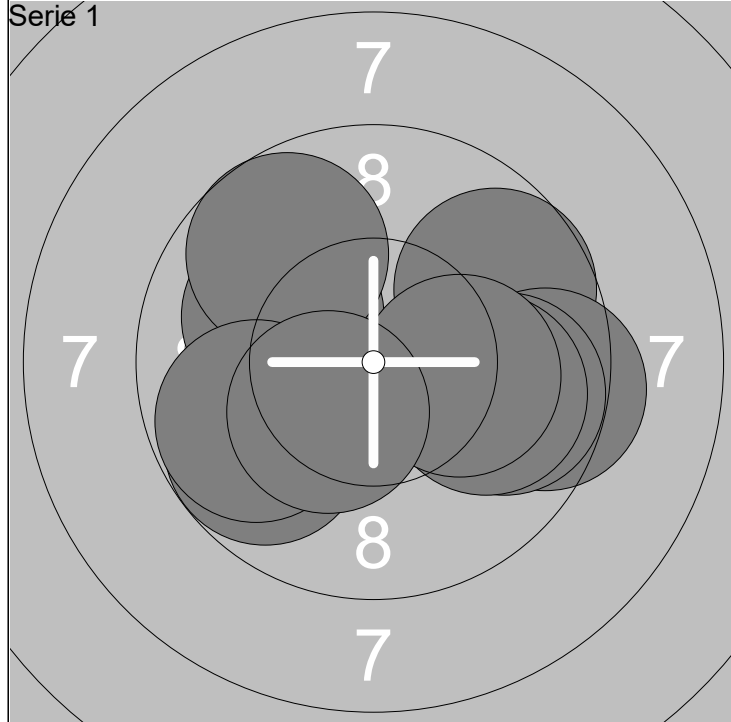

1: 10.0 ↖	6: 9.9 →	Serie	98.6
2: 9.7 ↗	7: 10.2x →		
3: 9.7 ↘	8: 9.7 ↙	Total	98.6
4: 9.4 →	9: 9.8 ↙		
5: 9.8 →	10: 10.4x ↙		

11: 10.1 ↗	16: 9.8 ←	Serie	100.9
12: 10.5x ↓	17: 9.8 ↓		
13: 10.4x ↖	18: 9.3 ←	Total	199.5
14: 10.5x ←	19: 10.8x →		
15: 10.1 ↗	20: 9.6 ↑		

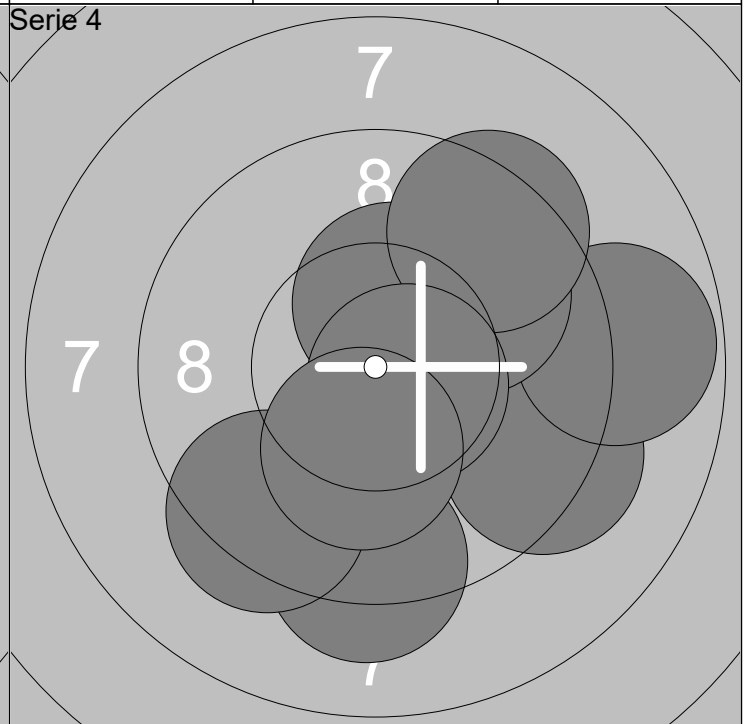
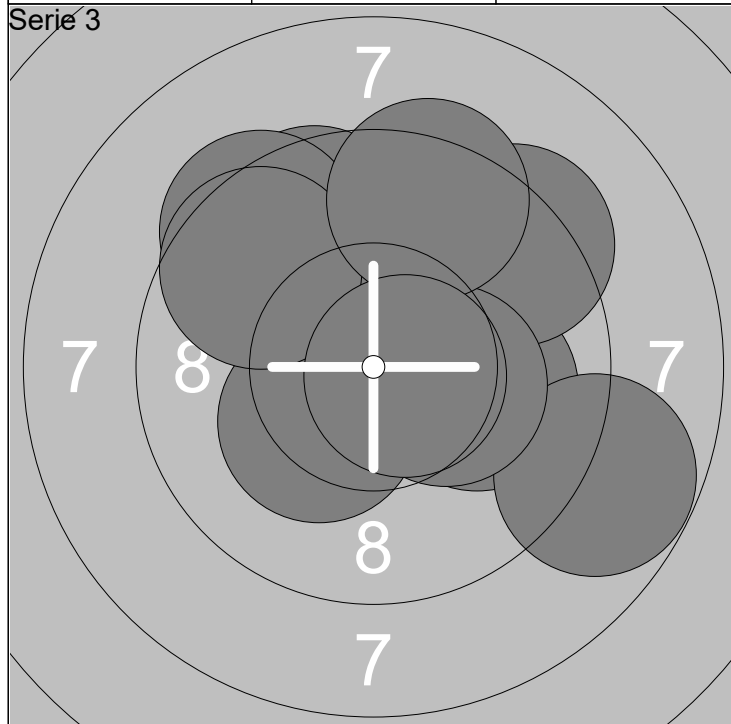

21: 10.3x ↙	26: 9.6 ↖	Serie	97.4
22: 9.6 ↗	27: 8.8 ↘		
23: 9.4 ↗	28: 10.3x →	Total	296.9
24: 10.0 →	29: 9.4 ↗		
25: 9.3 ↗	30: 10.7x →		

31: 10.6x ↘	36: 9.9 ↗	Serie	97.8
32: 9.3 ↘	37: 10.4x ↑		
33: 8.8 →	38: 9.4 ↗	Total	394.7
34: 9.2 ↓	39: 10.6x ↘		
35: 9.4 ↙	40: 10.2x ↓		

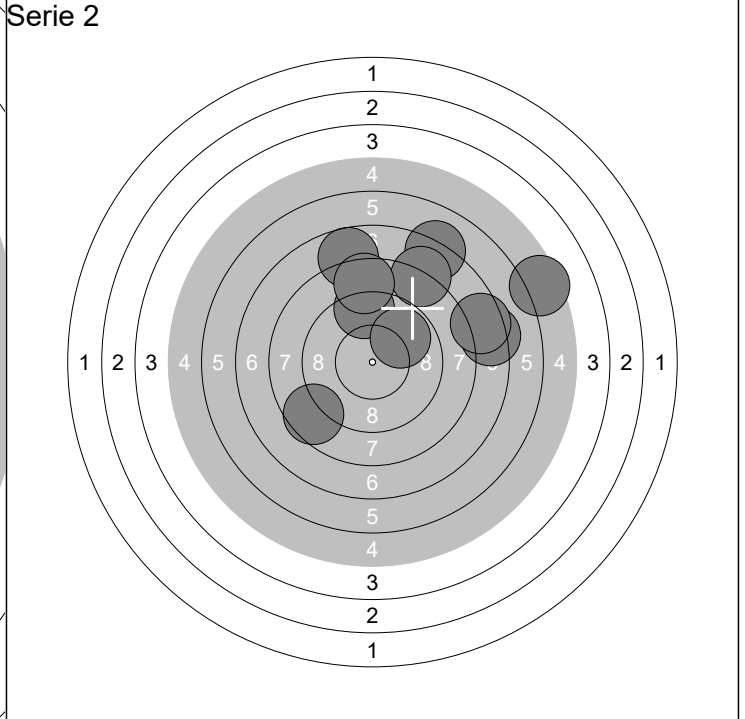
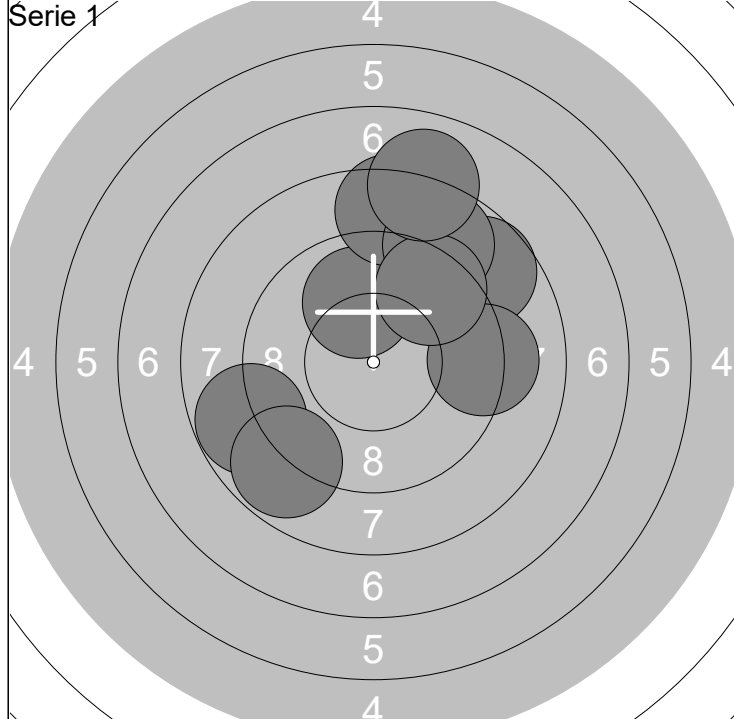

1: 8.7 ↗	6: 9.2 →	Serie	89.3
2: 9.0 ↑	7: 8.8 ↘		
3: 10.0 ↑	8: 8.8 ↗	Total	89.3
4: 8.5 ↑	9: 9.5 ↗		
5: 8.8 ↙	10: 8.0 ↑		

11: 8.6 ↙	16: 8.0 ↗	Serie	79.5
12: 7.8 ↑	17: 5.5 →		
13: 7.3 →	18: 9.3 ↑	Total	168.8
14: 7.5 →	19: 8.6 ↑		
15: 7.1 ↑	20: 9.8 ↗		

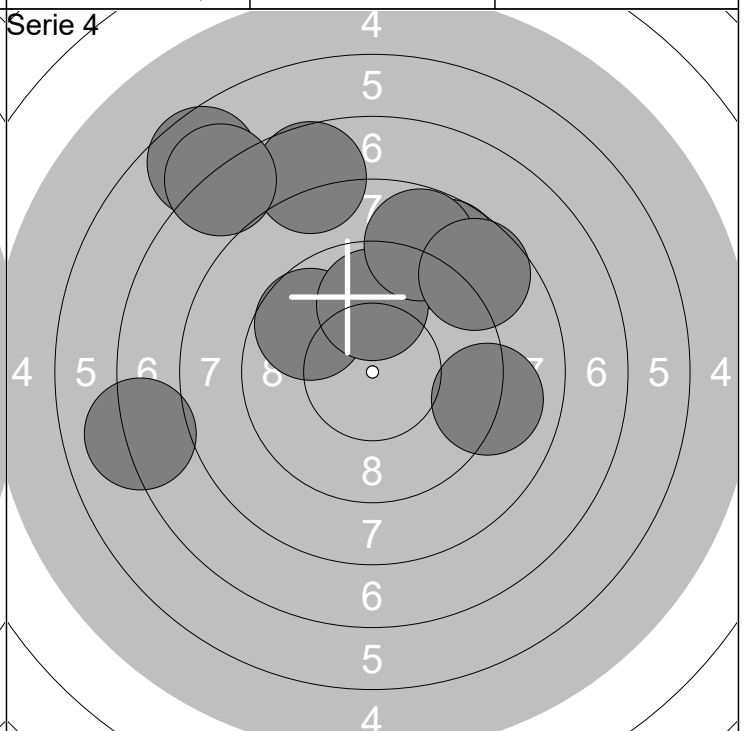
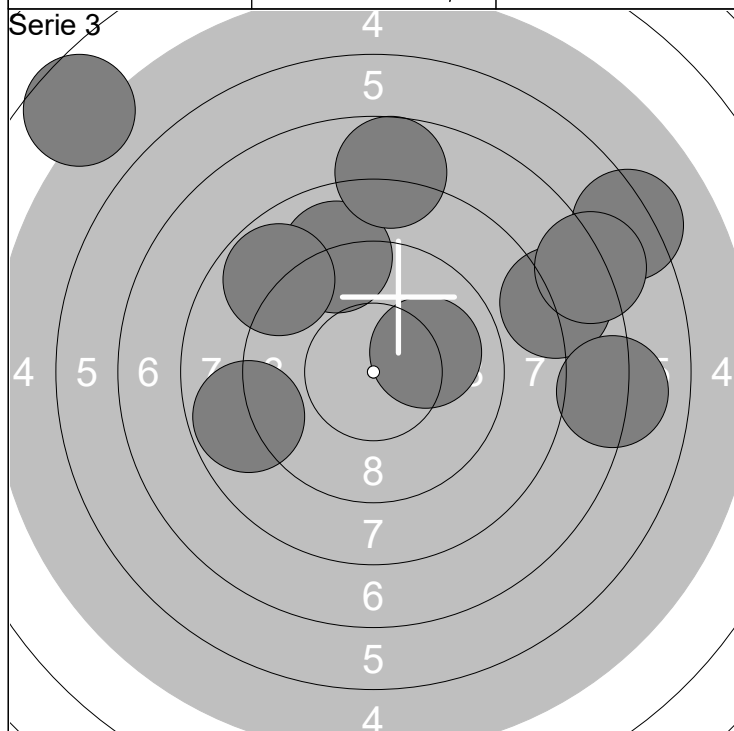

21: 8.8 ↙	26: 9.0 ↑	Serie	77.1
22: 7.8 →	27: 8.8 ↘		
23: 7.1 →	28: 7.7 ↑	Total	245.9
24: 6.2 ↗	29: 10.0 →		
25: 4.6 ↘	30: 7.1 ↗		

31: 7.7 ↑	36: 9.9 ↑	Serie	83.3
32: 7.1 ↙	37: 6.6 ↘		
33: 9.7 ↘	38: 7.0 ↘	Total	329.2
34: 9.1 →	39: 8.8 ↑		
35: 8.7 ↗	40: 8.7 ↗		

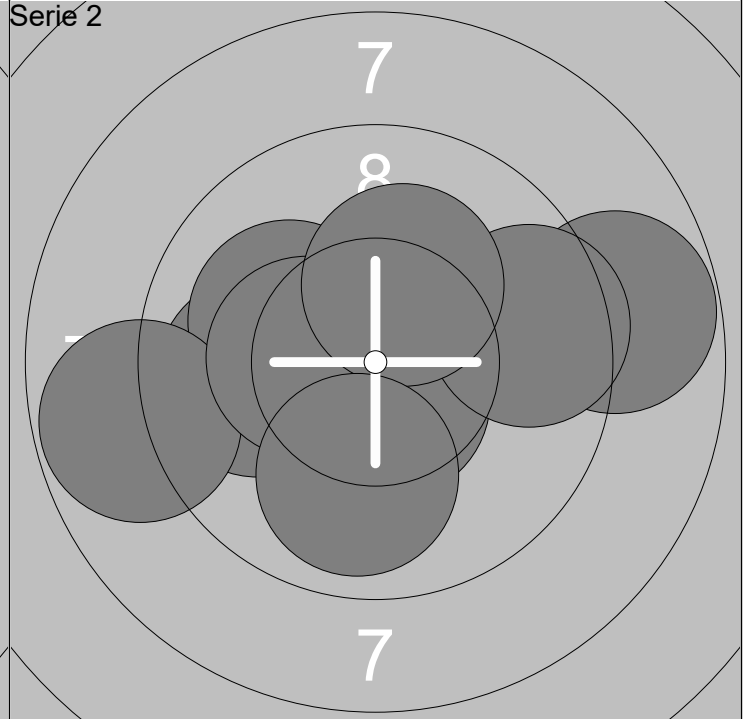
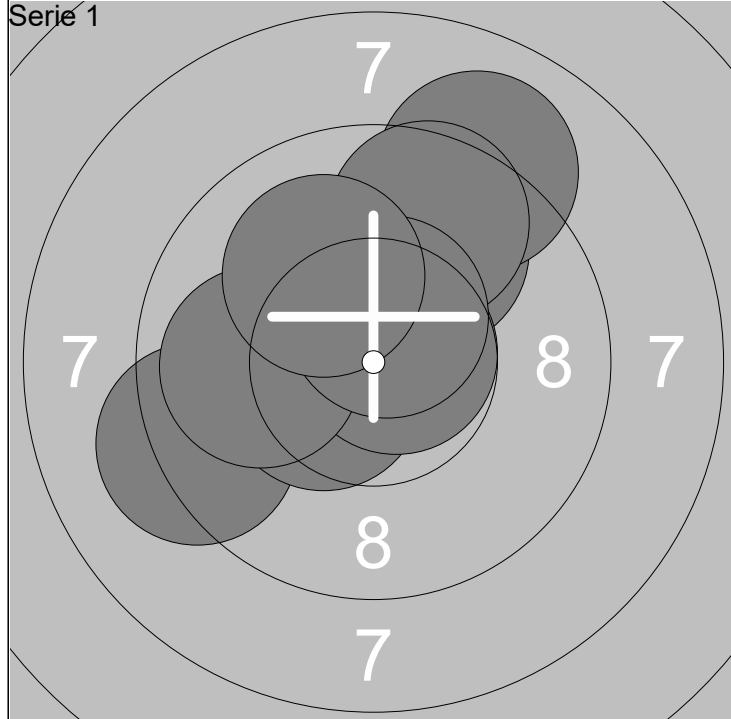

1: 9.2 ←	6: 9.9 ←	Serie 99.6
2: 10.4x ←	7: 9.0 ↗	
3: 9.8 ↗	8: 9.6 ↗	Total 99.6
4: 10.7x →	9: 10.5x ↗	
5: 10.4x ↑	10: 10.1 ↘	

11: 9.9 ←	16: 8.8 ←	Serie 98.9
12: 10.8x ↗	17: 10.3x ←	
13: 10.6x ↓	18: 9.5 →	Total 198.5
14: 8.8 →	19: 10.2x ↗	
15: 10.1 ←	20: 9.9 ↓	

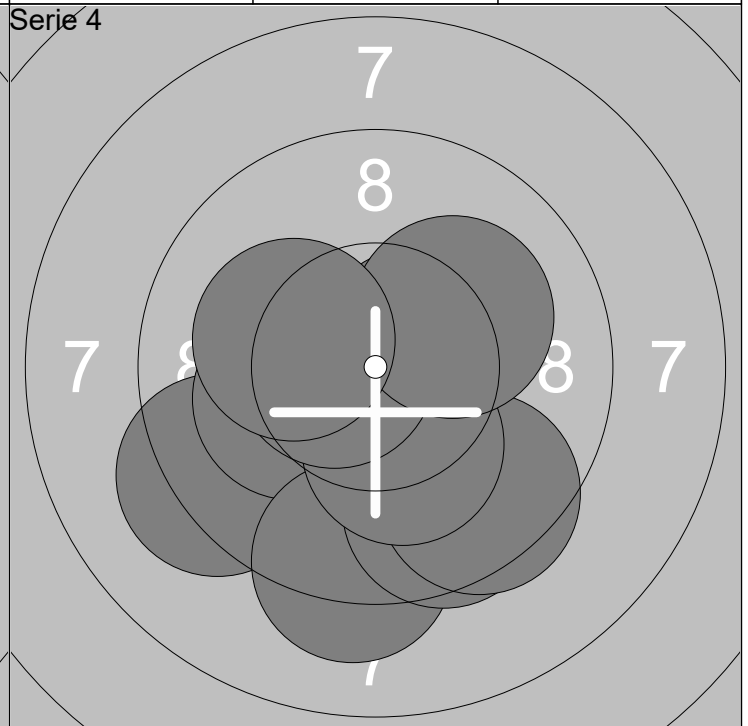
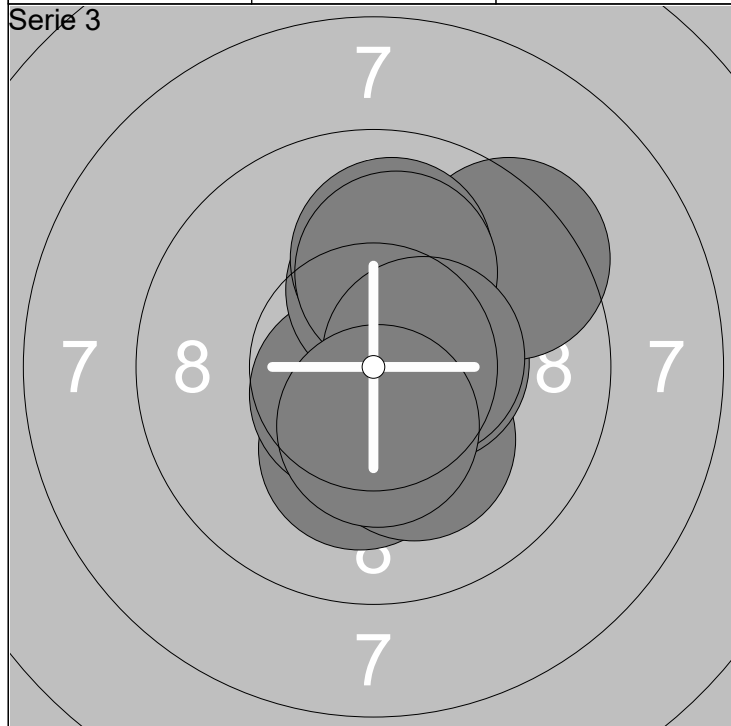

21: 10.2x ↓	26: 10.3x ↑	Serie 102.2
22: 10.2x ↓	27: 10.0 ↑	
23: 10.6x ↙	28: 10.1 ↑	Total 300.7
24: 10.5x →	29: 10.5x →	
25: 9.4 ↗	30: 10.4x ↓	

31: 9.3 ←	36: 9.5 ↓	Serie 99.5
32: 10.6x →	37: 10.2x ↓	
33: 10.2x ←	38: 10.6x ←	Total 400.2
34: 9.2 ↓	39: 10.1 ↗	
35: 9.6 ↓	40: 10.2x ←	

Skjutlag  
**4**Tavla  
**20****Per-Ola Waldmanis**

Rottne Industri Cup 2019

Alvesta Skytteförening

L Vet

26.10.2019

Rottne Industri Cup 2019

Söraby SKF

Serie 1

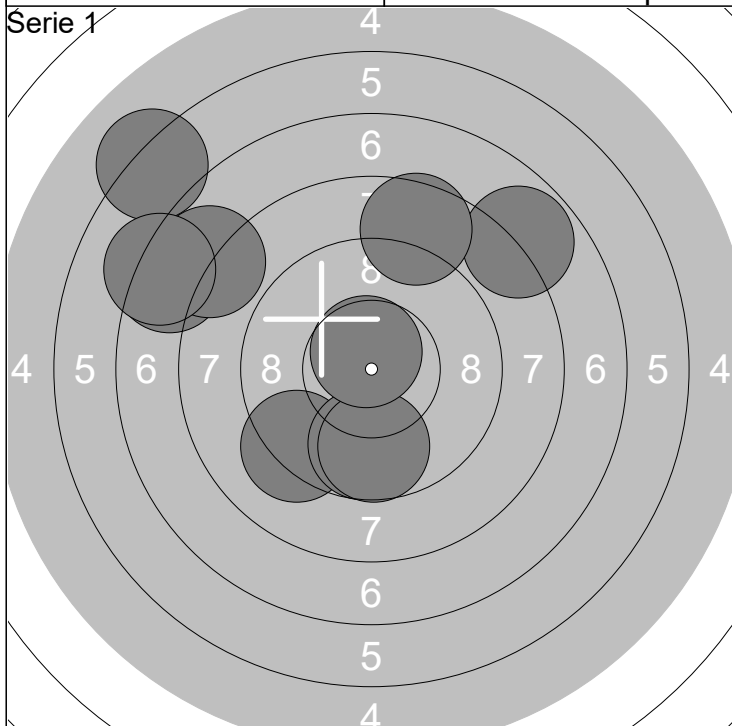

Serie 2

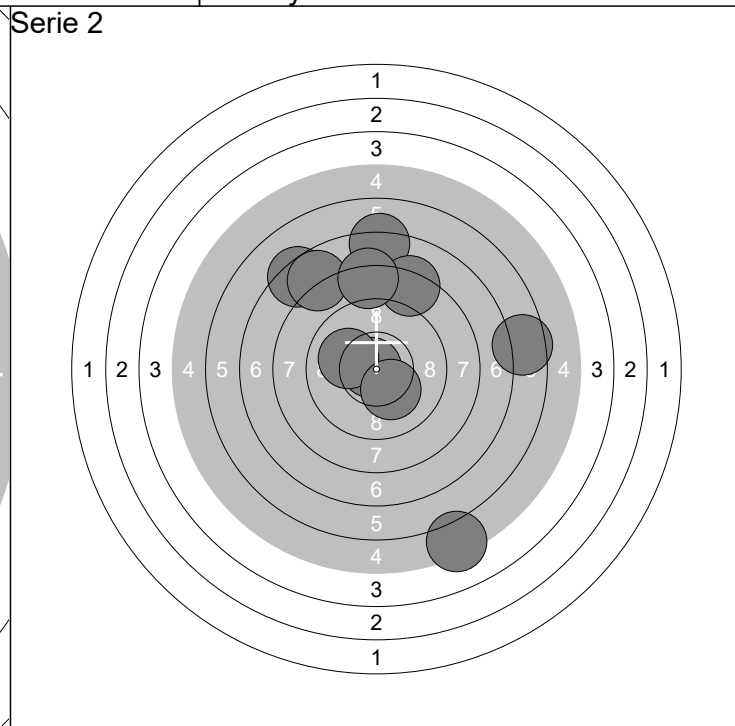

1: 7.8 ↗  
2: 9.2 ↘  
3: 9.7 ↓  
4: 7.4 ←  
5: 6.1 ↖

6: 9.7 ↓  
7: 8.6 ↑  
8: 7.8 ↖  
9: 7.2 ↖  
10: 10.7x ↑

Serie 84.2  
Total 84.2

11: 7.2 ↑  
12: 7.3 ↗  
13: 6.5 →  
14: 10.8x ←  
15: 10.0 ↖

16: 7.8 ↗  
17: 5.3 ↓  
18: 8.3 ↑  
19: 8.2 ↑  
20: 10.2x ↓

Serie 81.6  
Total 165.8

Serie 3

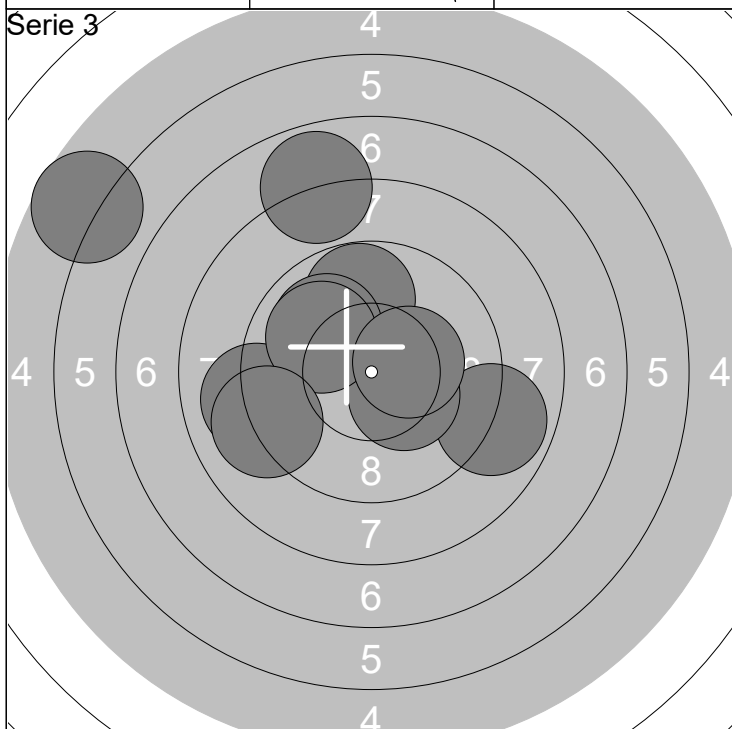

Serie 4

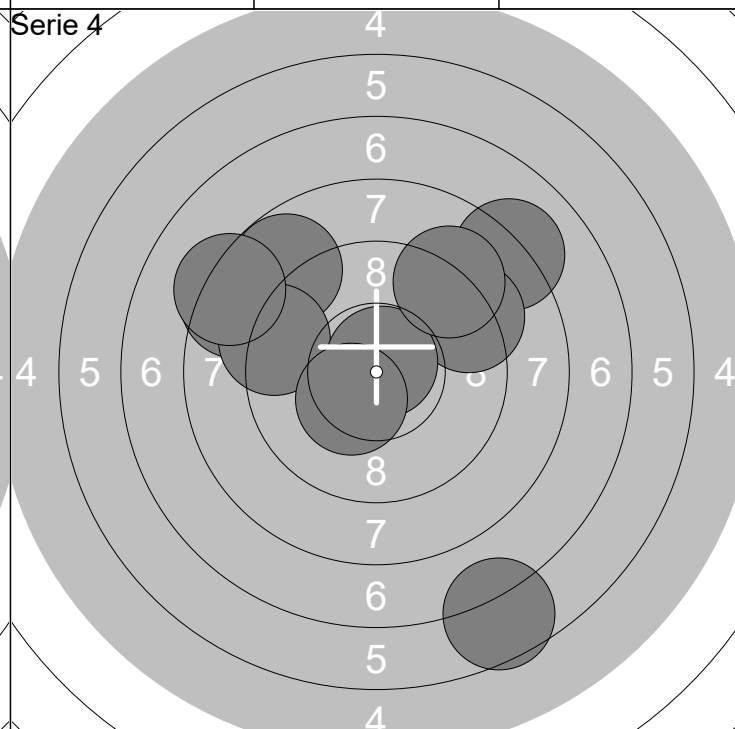

21: 9.0 ←  
22: 9.8 ↑  
23: 8.9 →  
24: 5.7 ↖  
25: 10.0 ↗

26: 10.3x →  
27: 10.0 ↖  
28: 7.9 ↑  
29: 9.1 ←  
30: 10.3x →

Serie 91.0  
Total 256.8

31: 8.4 ↖  
32: 8.1 ↗  
33: 6.6 ↓  
34: 8.8 ↗  
35: 9.2 ←

36: 9.2 ↗  
37: 10.8x ↑  
38: 8.2 ↖  
39: 10.4x ↘  
40: 9.1 ↗

Serie 88.8  
Total 345.6

Rottne Industri Cup 2019

Serie 1

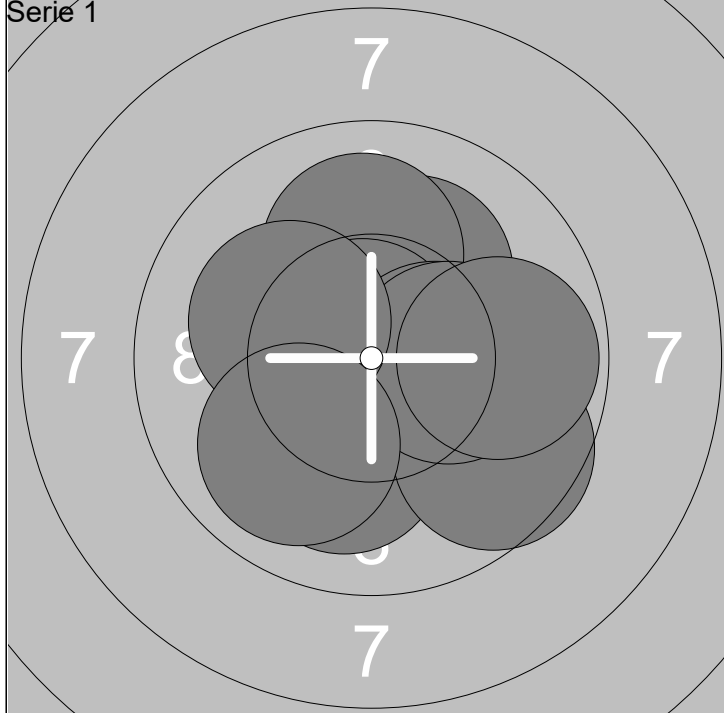

1: 10.2x ↗	6: 9.6 ↘
2: 10.1 ↓	7: 10.3x →
3: 10.0 ↑	8: 10.2x ↖
4: 10.8x ↗	9: 9.8 →
5: 10.4x →	10: 10.0 ↘

Serie	101.4
Total	101.4

Serie 2

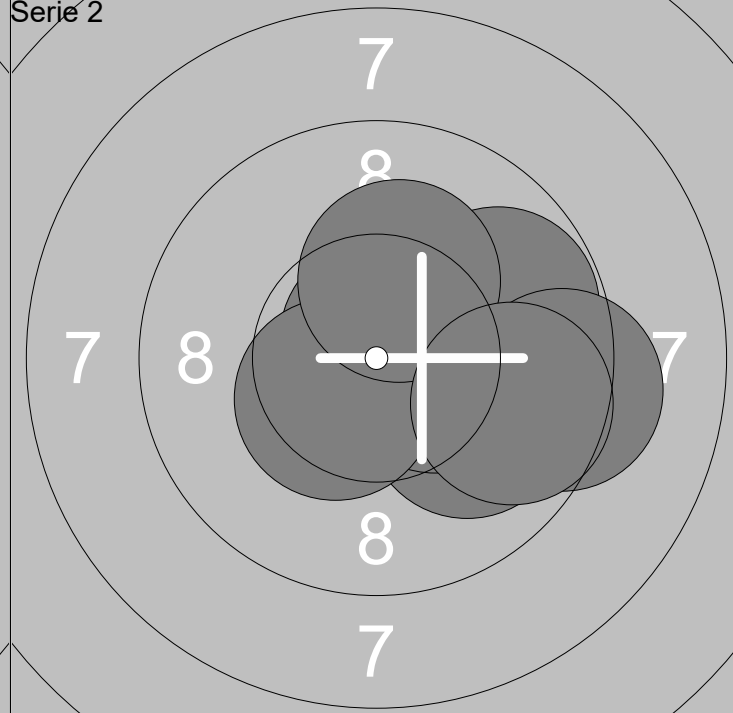

11: 10.4x →	16: 9.8 →
12: 10.0 ↘	17: 10.4x ↙
13: 10.8x ↑	18: 10.2x ↑
14: 10.5x ↗	19: 9.3 →
15: 10.4x →	20: 9.7 →

Serie	101.5
Total	202.9

Serie 3

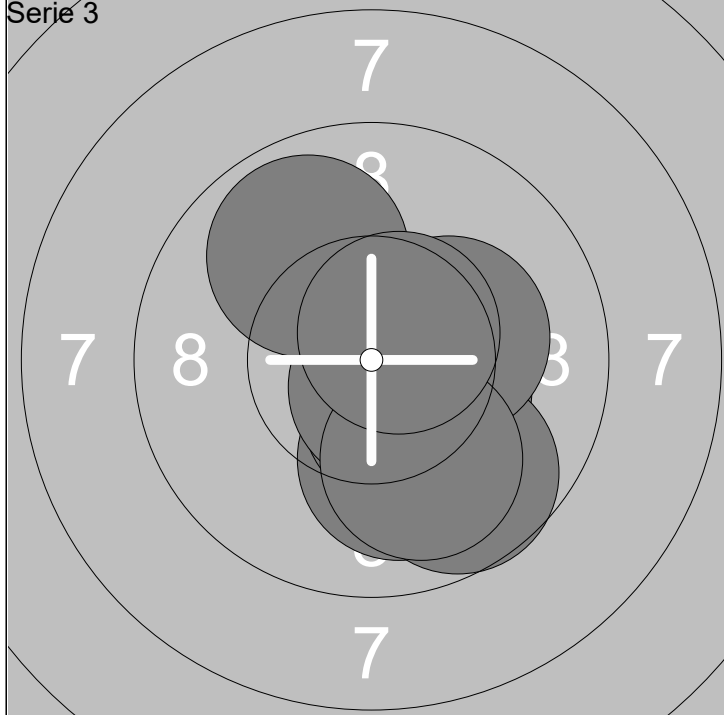

21: 10.3x →	26: 9.7 ↘
22: 10.1 ↓	27: 10.2x →
23: 10.4x ↘	28: 9.9 ↗
24: 10.4x →	29: 10.0 ↘
25: 10.7x ↘	30: 10.6x ↗

Serie	102.3
Total	305.2

Serie 4

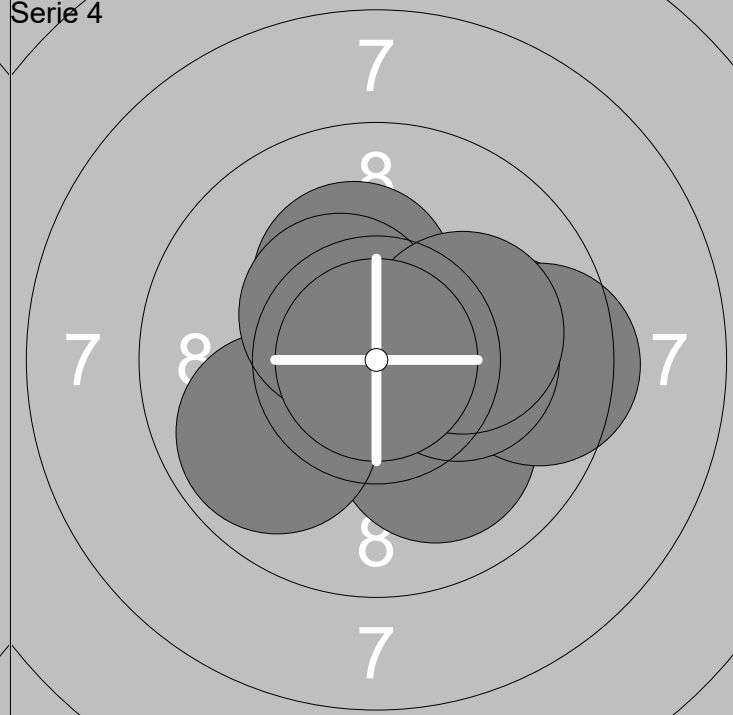

31: 9.9 →	36: 9.9 ↙
32: 10.6x ↗	37: 10.4x ↖
33: 10.1 ↘	38: 10.2x →
34: 9.5 →	39: 10.1 →
35: 10.2x ↑	40: 10.9x

Serie	101.8
Total	407.0

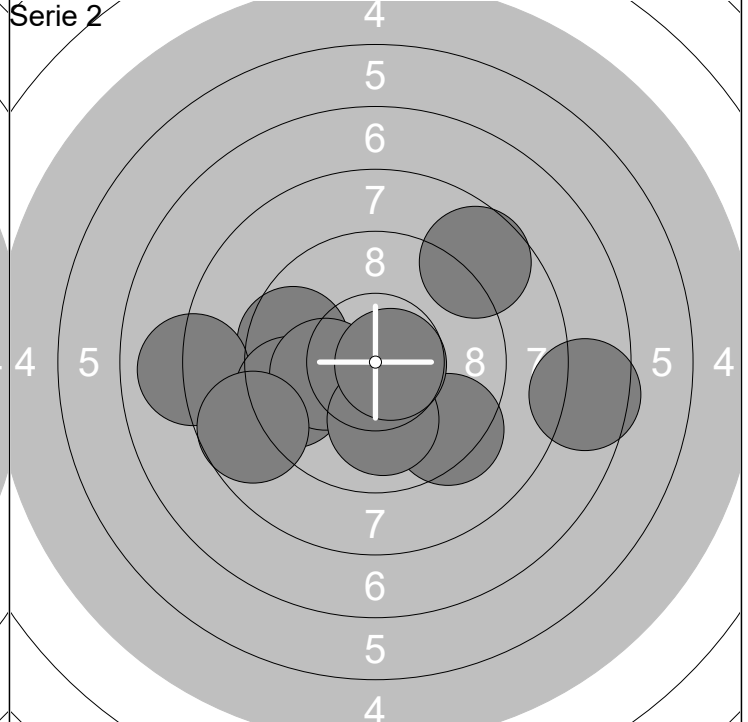
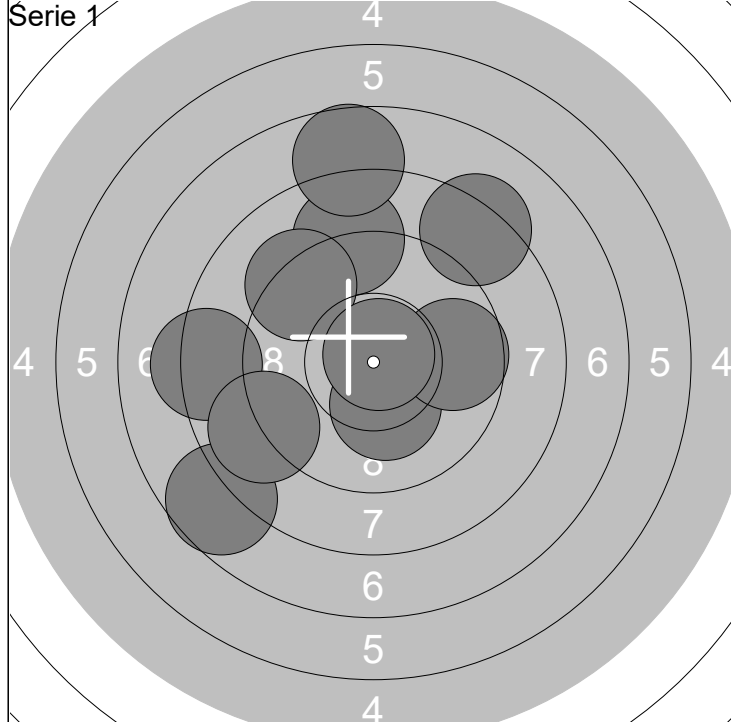

1: 10.2x ↓	6: 8.3 ←	Serie 89.8
2: 7.7 ↙	7: 9.7 →	
3: 9.0 ↑	8: 8.3 ↗	Total 89.8
4: 7.7 ↑	9: 10.8x ↗	
5: 9.2 ↖	10: 8.9 ←	

11: 9.6 ←	16: 10.0 ↓	Serie 92.1
12: 8.0 ←	17: 8.7 ↗	
13: 9.5 ←	18: 10.7x →	Total 181.9
14: 9.3 ↘	19: 8.7 ←	
15: 10.1 ←	20: 7.5 →	

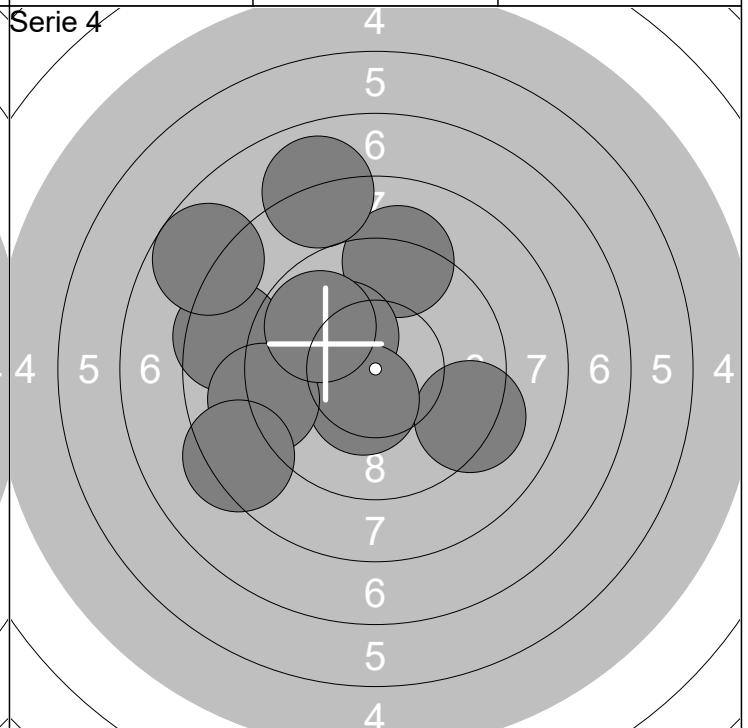
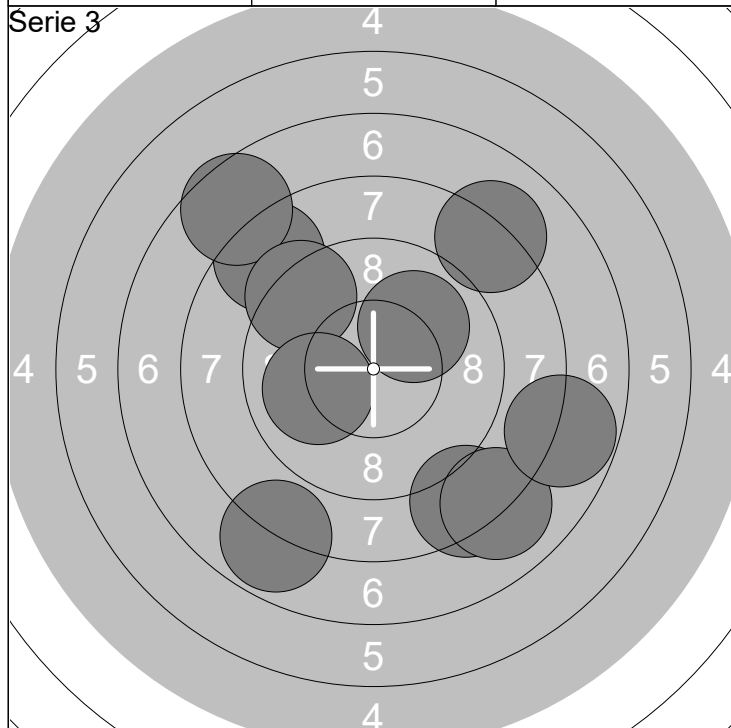

21: 8.5 ↖	26: 7.6 ↖	Serie 85.6
22: 8.4 ↓	27: 9.3 ↖	
23: 7.9 ↘	28: 7.8 →	Total 267.5
24: 8.1 ↗	29: 10.0 ↗	
25: 8.0 ↓	30: 10.0 ←	

31: 9.3 →	36: 9.1 ←	Serie 90.6
32: 9.2 ↑	37: 8.4 ↙	
33: 10.2x ↖	38: 9.8 ↖	Total 358.1
34: 8.5 ←	39: 7.8 ↖	
35: 10.4x ↘	40: 7.9 ↑	

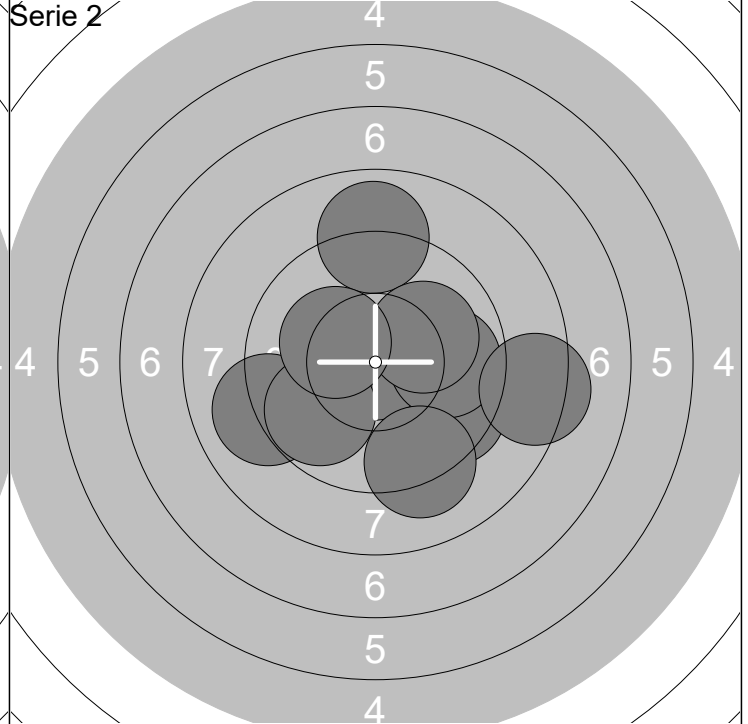
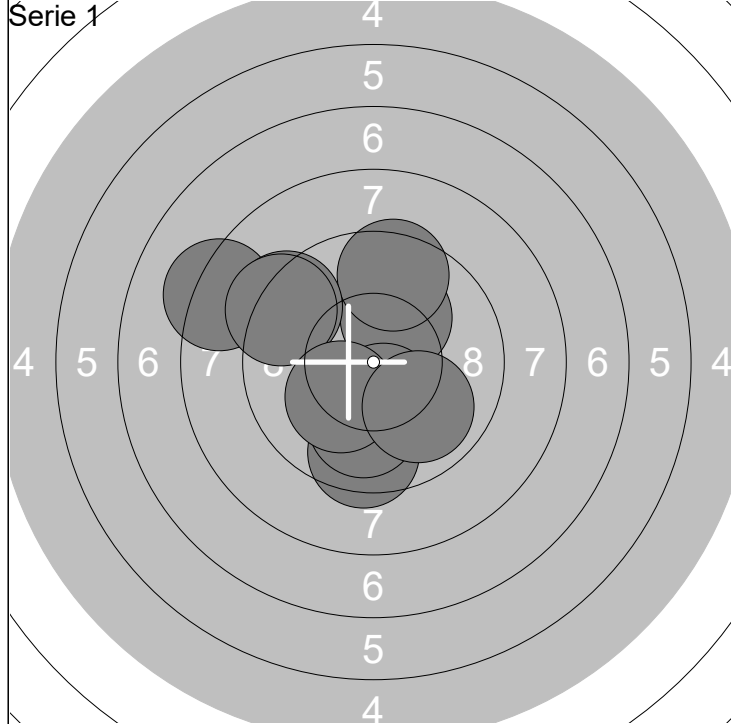

1: 10.2x ↗	6: 9.5 ↓	Serie	96.3
2: 9.5 ↑	7: 10.0 ↓		
3: 8.2 ↖	8: 9.2 ↖	Total	96.3
4: 10.3x ↓	9: 10.2x ↙		
5: 9.3 ↖	10: 9.9 ↘		

11: 9.5 ↘	16: 8.9 ↑	Serie	95.9
12: 10.9x ↙	17: 8.4 →		
13: 9.8 →	18: 10.1 ↗	Total	192.2
14: 9.1 ↖	19: 10.2x ↖		
15: 9.8 ↙	20: 9.2 ↓		

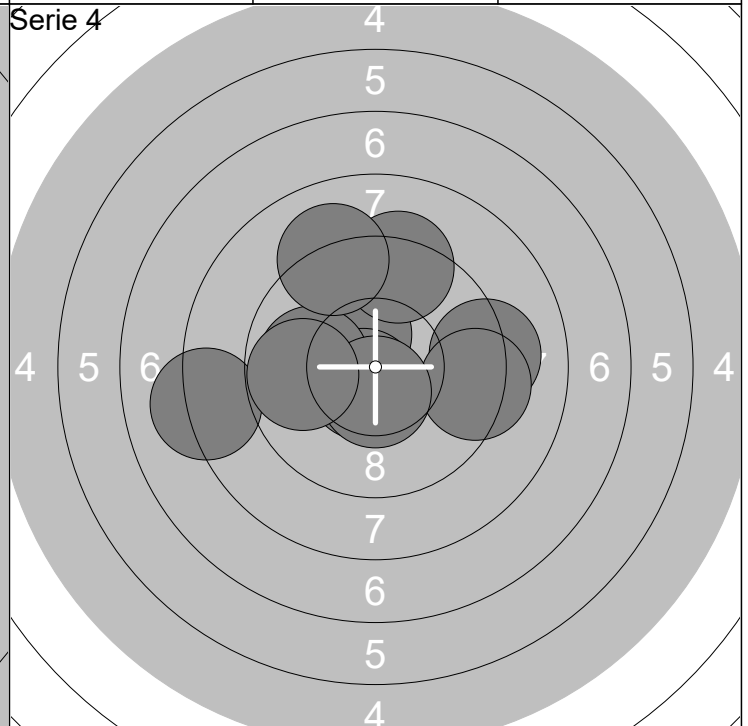
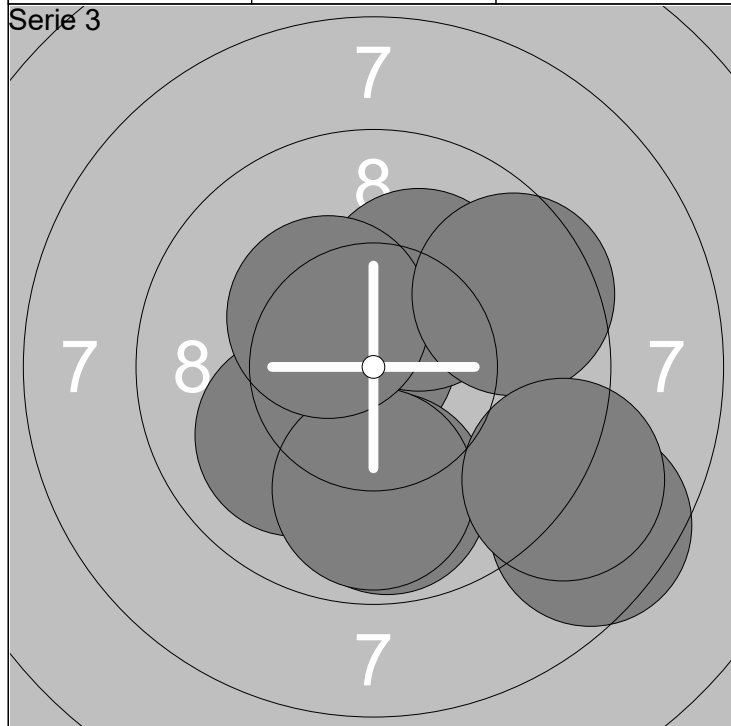

21: 10.7x ↖	26: 9.8 ↓	Serie	98.9
22: 10.8x ↖	27: 9.9 ↓		
23: 8.6 ↘	28: 10.3x ↗	Total	291.1
24: 10.2x ↗	29: 9.6 ↗		
25: 10.0 ↖	30: 9.0 ↘		

31: 8.2 ↖	36: 9.9 ↖	Serie	96.3
32: 10.4x ↗	37: 9.1 ↗		
33: 9.2 →	38: 9.3 →	Total	387.4
34: 10.6x ↙	39: 10.5x ↓		
35: 9.3 ↑	40: 9.8 ↖		



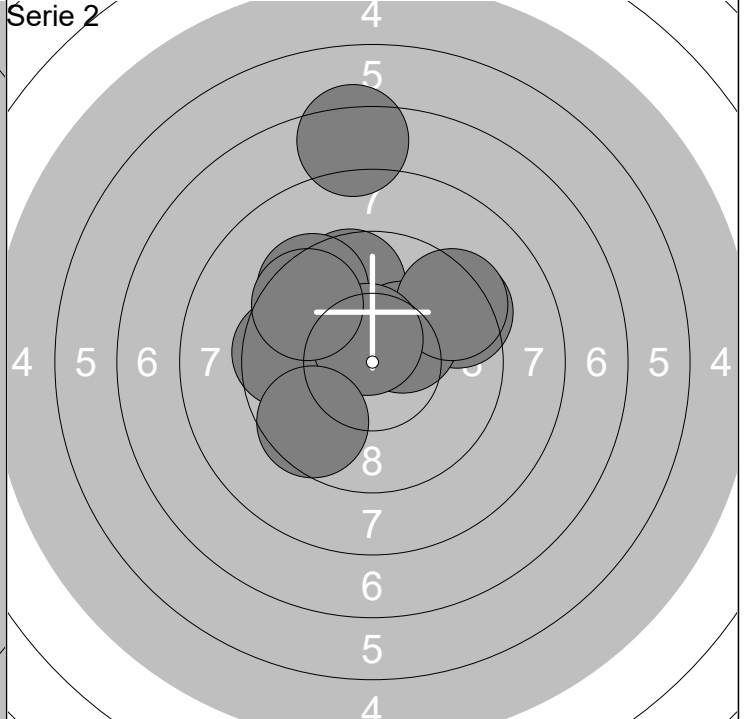
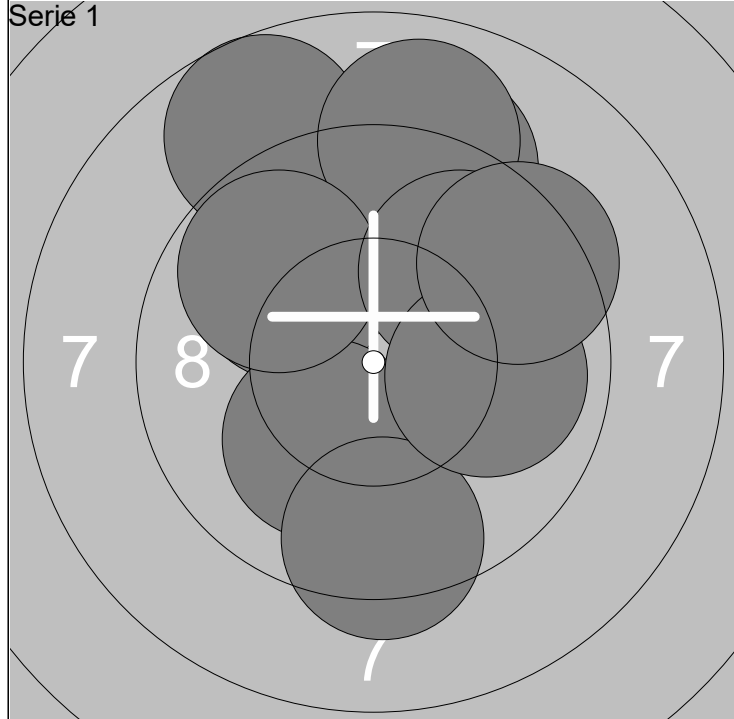

1: 9.9 ↖	6: 9.4 ↓	Serie	95.3
2: 9.1 ↑	7: 9.8 ↖		
3: 8.7 ↖	8: 9.8 ↗	Total	95.3
4: 9.0 ↑	9: 10.0 →		
5: 10.2x ↙	10: 9.4 ↗		

11: 7.4 ↑	16: 9.4 ↗	Serie	95.0
12: 9.6 ←	17: 9.5 ↖		
13: 9.4 ↗	18: 10.6x ↑	Total	190.3
14: 9.6 ↑	19: 9.6 ↖		
15: 10.3x ↗	20: 9.6 ↙		

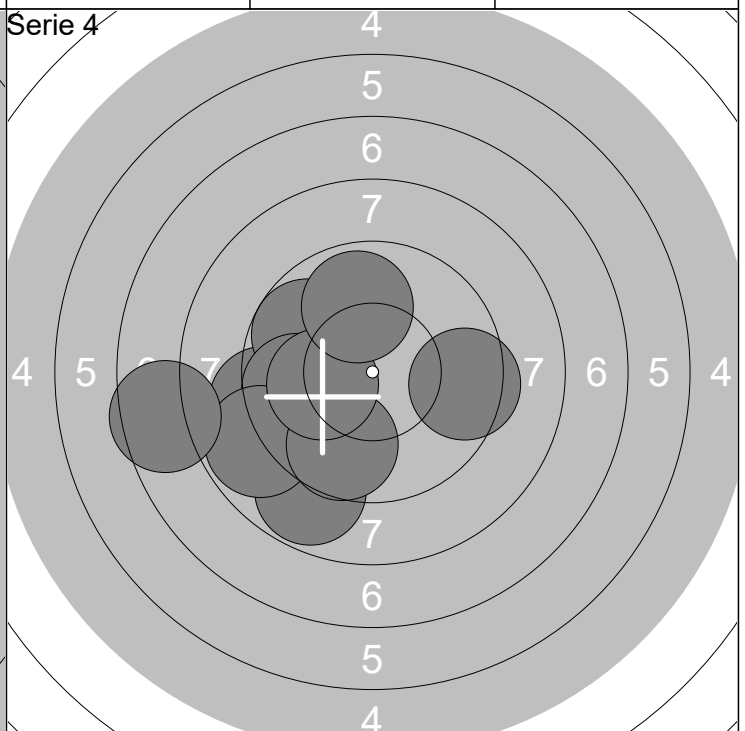
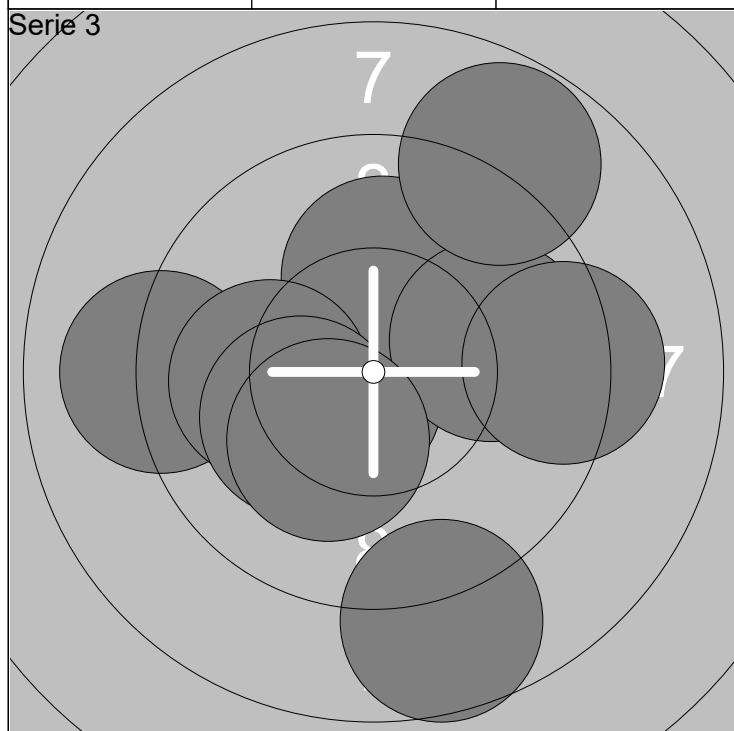

21: 10.6x ↙	26: 8.8 ↗	Serie	96.9
22: 10.1 ↑	27: 10.2x ↙		
23: 9.1 ←	28: 8.7 ↓	Total	287.2
24: 10.0 ←	29: 9.3 →		
25: 9.9 →	30: 10.2x ↙		

31: 9.2 ←	36: 8.8 ↙	Serie	93.1
32: 9.5 →	37: 7.6 ←		
33: 8.8 ↙	38: 9.7 ↙	Total	380.3
34: 9.8 ↖	39: 10.1 ←		
35: 9.7 ←	40: 9.9 ↑		

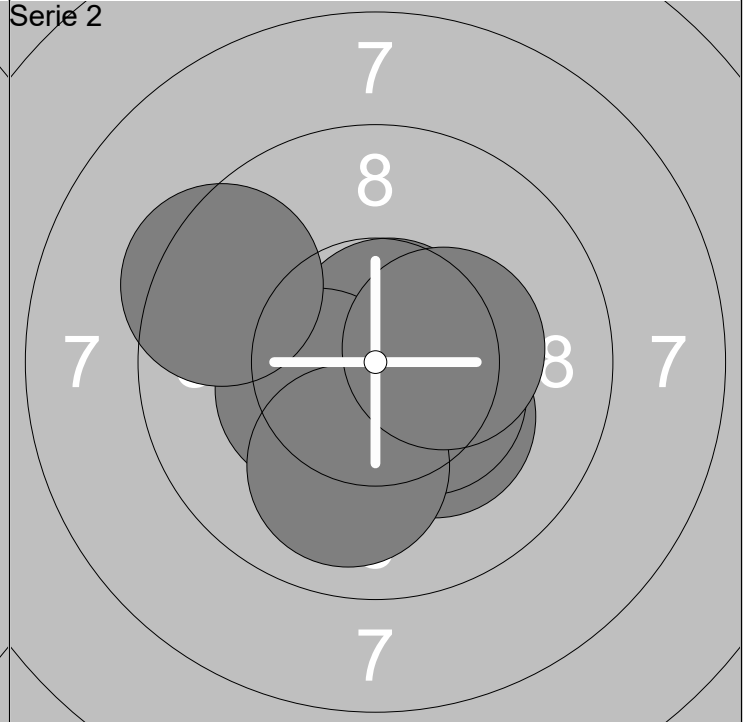
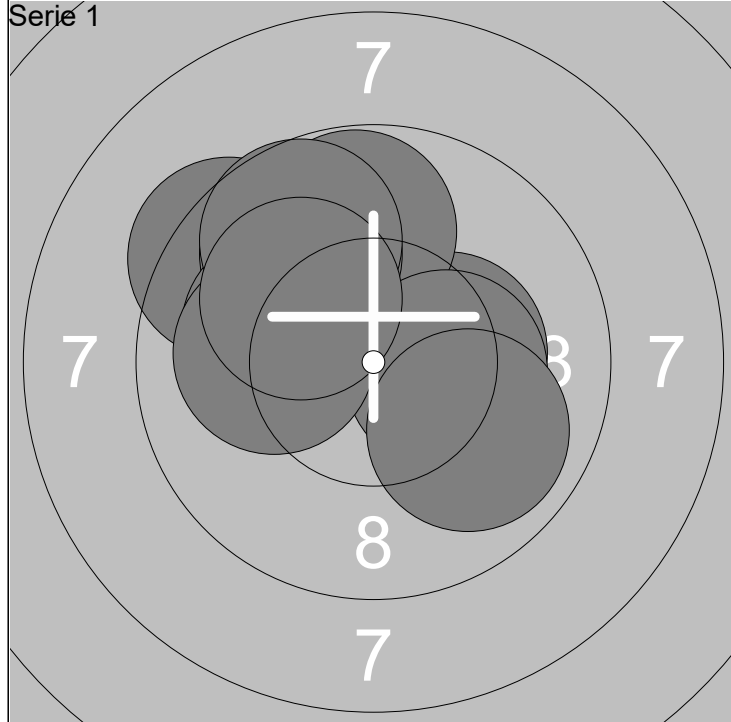

1: 9.4 ↖	6: 10.1 ↙	Serie 99.5
2: 10.3x →	7: 9.7 ↗	
3: 9.8 ↑	8: 10.1 ←	Total 99.5
4: 9.8 ↗	9: 9.9 ↘	
5: 10.3x →	10: 10.1 ↗	

11: 10.5x ↓	16: 10.7x ↗	Serie 103.4
12: 10.3x ↘	17: 10.4x ↙	
13: 10.8x ↓	18: 9.4 ↖	Total 202.9
14: 10.5x ↘	19: 10.0 ↓	
15: 10.4x ↘	20: 10.4x →	

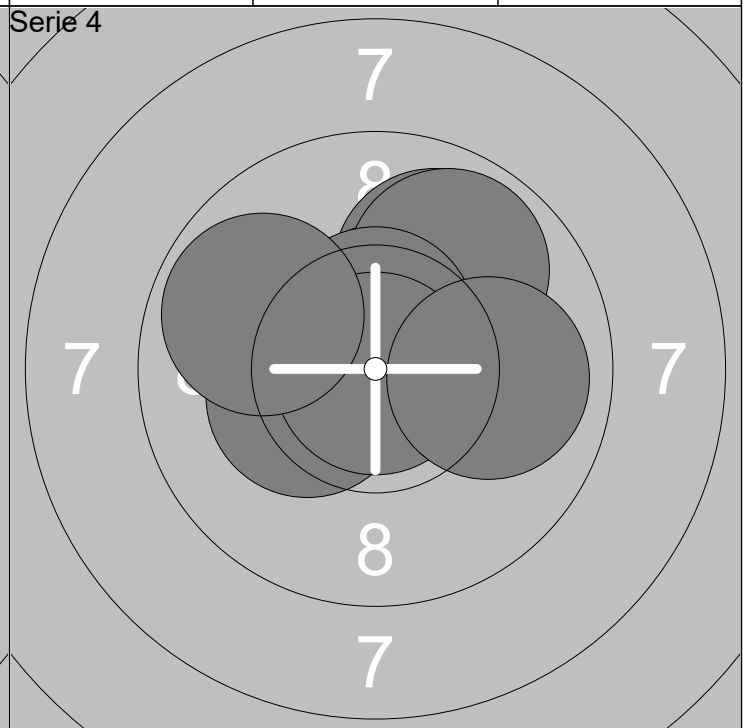
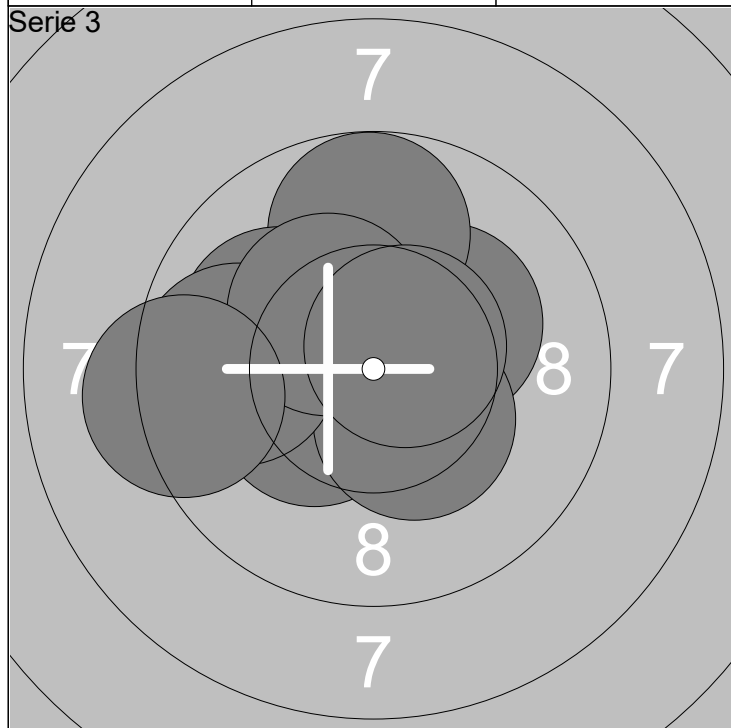

21: 10.2x ↗	26: 10.4x ↘	Serie 100.6
22: 9.7 ↑	27: 9.8 ←	
23: 10.1 ↙	28: 10.3x ↗	Total 303.5
24: 10.0 ↙	29: 9.2 ←	
25: 10.3x ↙	30: 10.6x ↗	

31: 9.9 ↗	36: 9.9 ↗	Serie 102.8
32: 10.5x ↑	37: 10.6x ↑	
33: 10.4x ↙	38: 10.9x ↓	Total 406.3
34: 10.5x ↗	39: 10.0 →	
35: 10.3x ↙	40: 9.8 ↖	

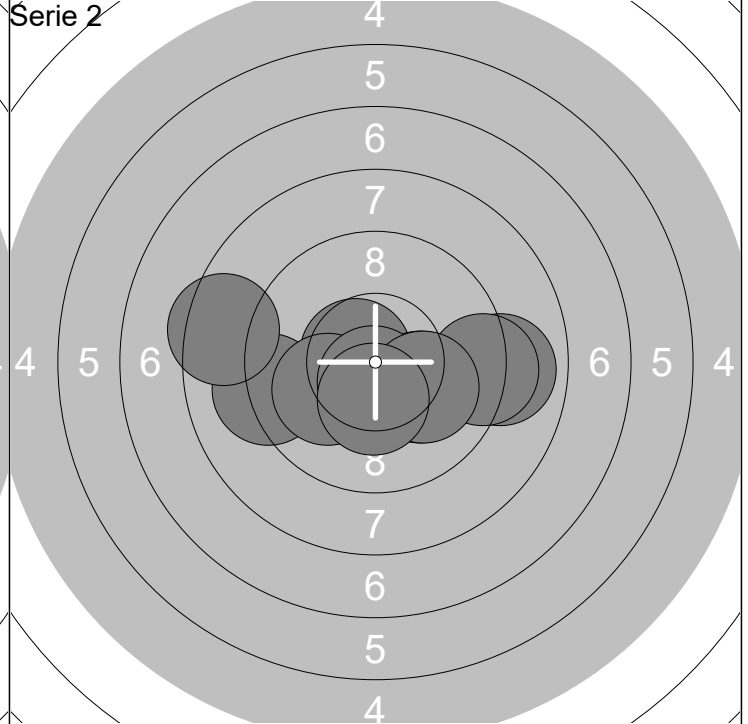
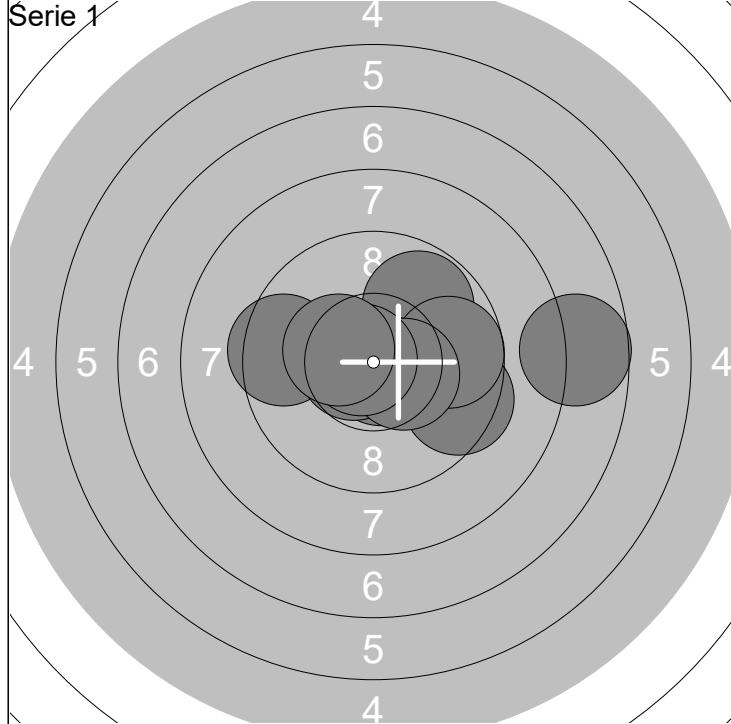

1: 9.8 ↗	6: 9.5 ←	Serie	99.0
2: 9.4 →	7: 10.6x ←		
3: 7.7 →	8: 10.4x →	Total	99.0
4: 9.7 →	9: 10.7x ←		
5: 10.8x ↓	10: 10.4x ←		

11: 9.2 ←	16: 8.4 ←	Serie	97.5
12: 10.6x ←	17: 10.6x ↓		
13: 10.1 →	18: 9.2 →	Total	196.5
14: 8.9 →	19: 10.1 →		
15: 10.1 ←	20: 10.3x ↓		

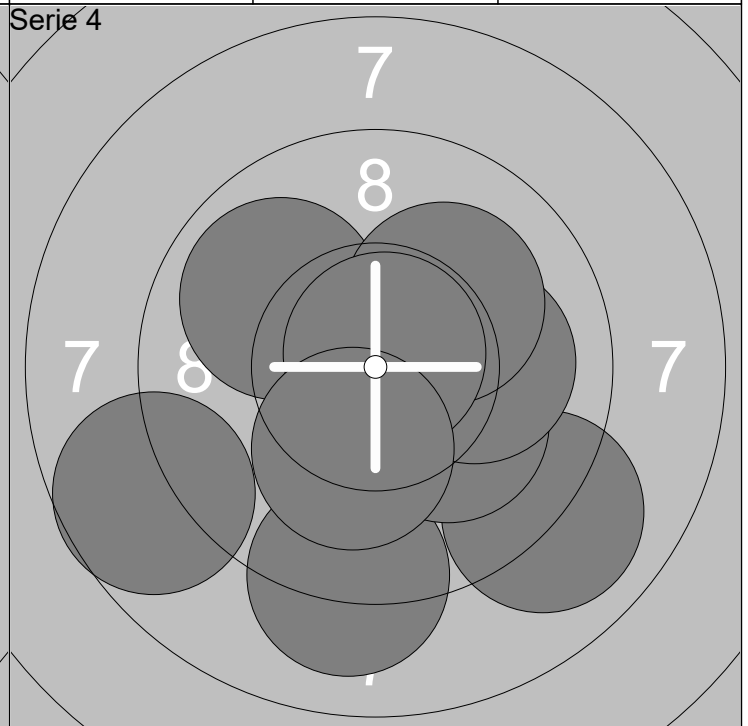
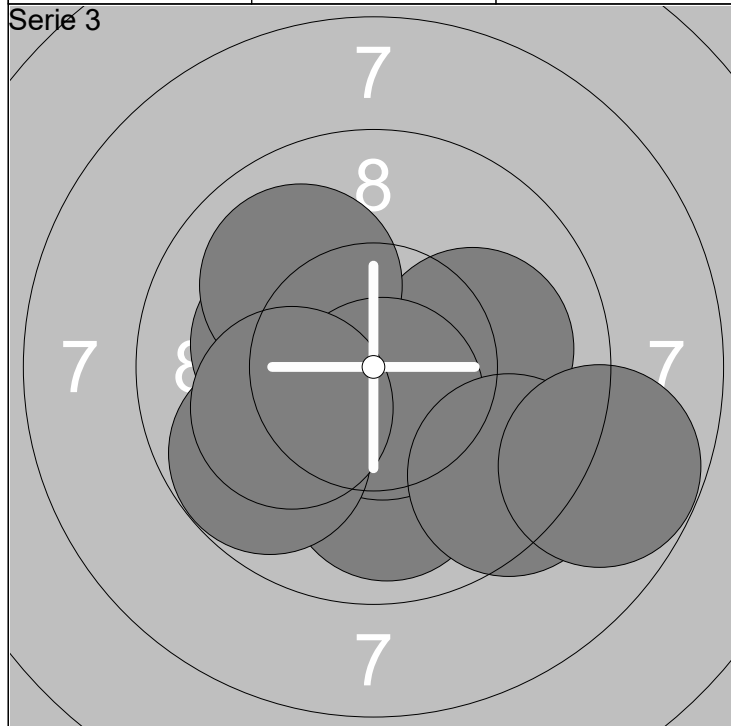

21: 10.1 →	26: 10.7x ↓	Serie	99.4
22: 9.9 ↓	27: 9.4 ↓		
23: 10.5x ←	28: 8.7 →	Total	295.9
24: 10.2x ←	29: 9.8 ←		
25: 10.0 ↗	30: 10.1 ←		

31: 9.9 ↖	36: 10.1 ↓	Serie	98.5
32: 8.7 ←	37: 10.1 →		
33: 9.0 ↓	38: 10.1 ↗	Total	394.4
34: 10.5x ↗	39: 10.8x ↗		
35: 9.1 ↓	40: 10.2x ↓		

Skjutlag  
**4**Tavla  
**27****Sture Håkansson**

Rottne Industri Cup 2019

Tingsryd Skytteförening

L Vet

26.10.2019

Rottne Industri Cup 2019

Söraby SKF

Serie 1

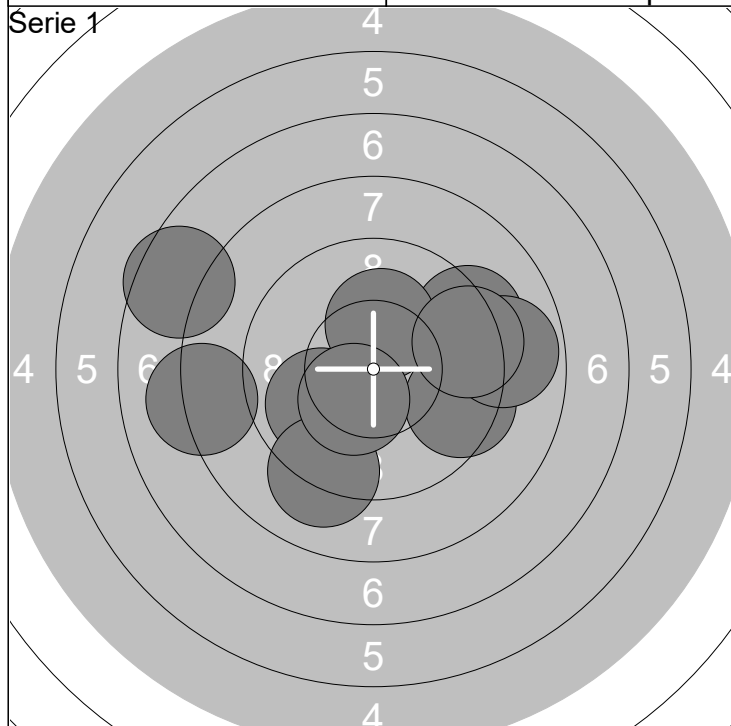

Serie 2

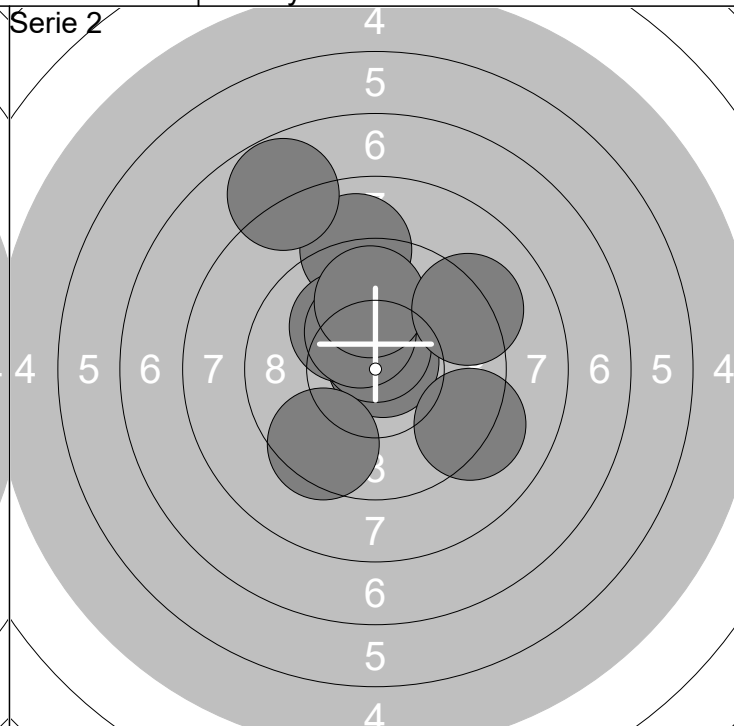

1:	9.3	↗
2:	9.5	→
3:	8.9	→
4:	9.9	↙
5:	9.1	↘
6:	8.1	↖
7:	10.2x	↑
8:	7.5	↖
9:	10.4x	↘
10:	9.4	→

Serie	92.3
Total	92.3

11:	10.8x	↗
12:	10.6x	↑
13:	9.0	↑
14:	10.1	↖
15:	9.2	↘
16:	10.3x	↖
17:	7.8	↖
18:	9.8	↑
19:	9.2	↗
20:	9.5	↘

Serie	96.3
Total	188.6

Serie 3

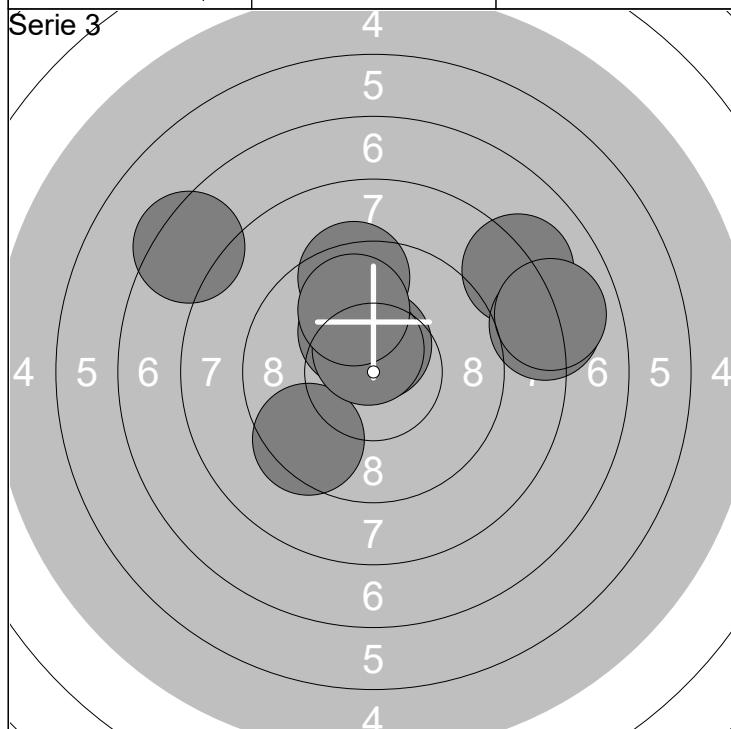

Serie 4

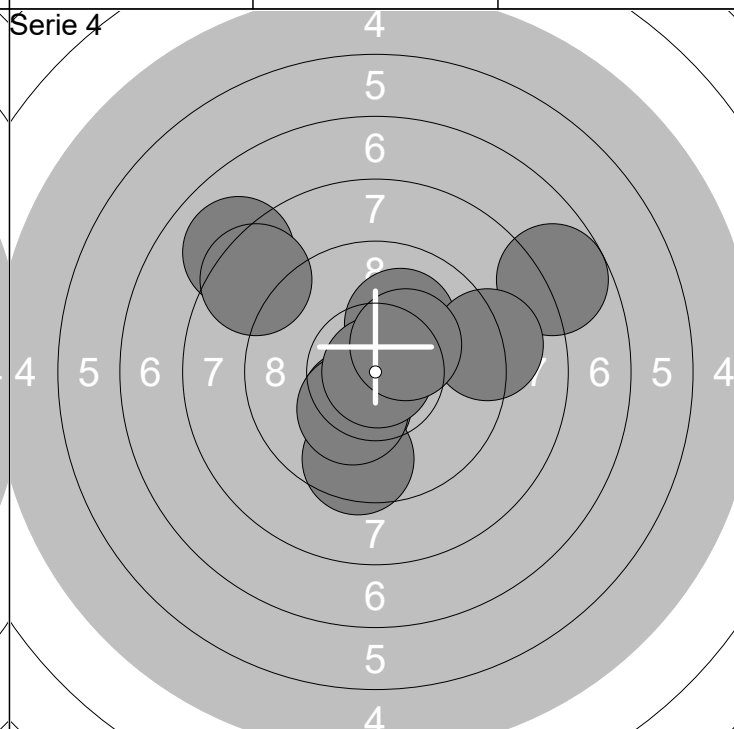

21:	9.4	↑
22:	8.1	↗
23:	8.1	→
24:	10.5x	↑
25:	10.3x	↖
26:	7.4	↖
27:	8.0	→
28:	9.5	↙
29:	10.6x	↑
30:	9.9	↑

Serie	91.8
Total	280.4

31:	10.4x	↘
32:	7.8	↗
33:	10.1	↑
34:	9.1	→
35:	8.0	↖
36:	9.5	↘
37:	8.5	↖
38:	10.3x	↘
39:	10.9x	→
40:	10.3x	↗

Serie	94.9
Total	375.3

Rottne Industri Cup 2019

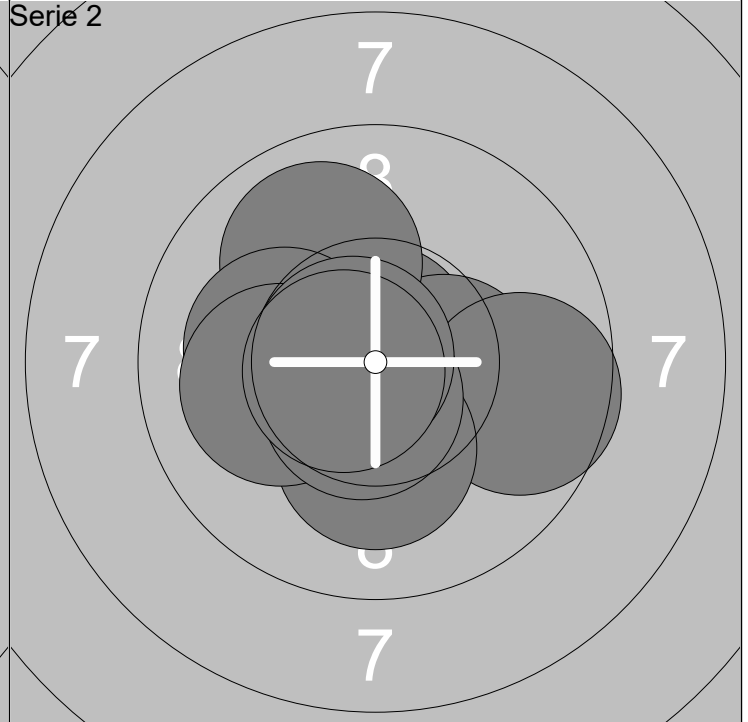
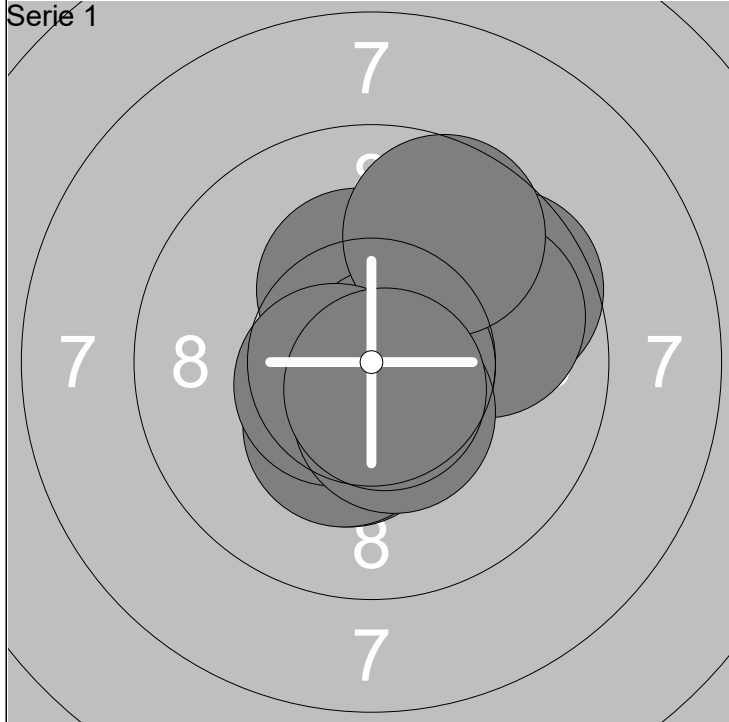

1: 9.6 ↗	6: 10.4x ↓	Serie	102.9
2: 9.9 →	7: 9.7 ↗		
3: 10.3x ↑	8: 10.6x ←	Total	102.9
4: 10.8x →	9: 10.5x ↓		
5: 10.4x ↓	10: 10.7x ↓		

11: 10.8x ↑	16: 10.2x ←	Serie	103.2
12: 10.3x →	17: 10.1 ←		
13: 9.6 →	18: 10.6x ↓	Total	206.1
14: 10.2x ↓	19: 10.8x ←		
15: 9.9 ↗	20: 10.7x ←		

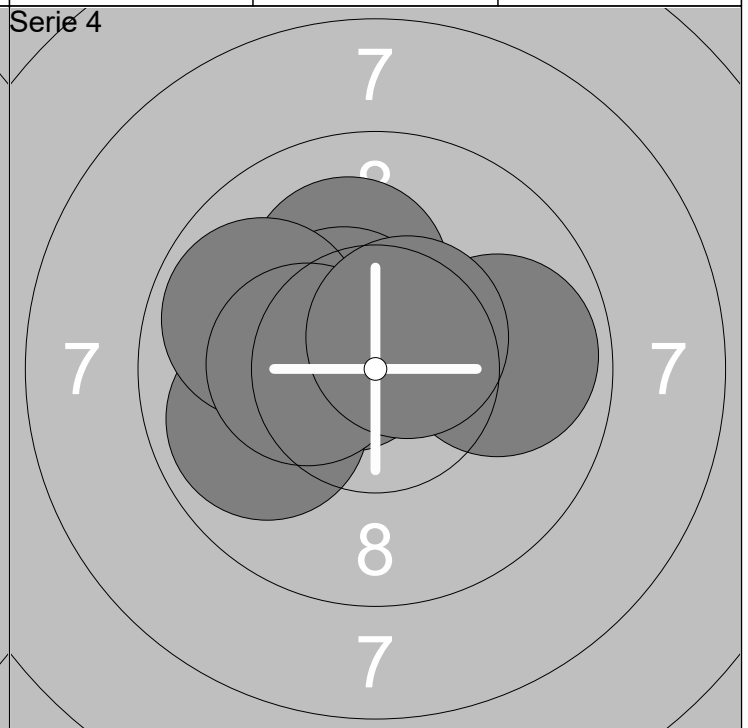
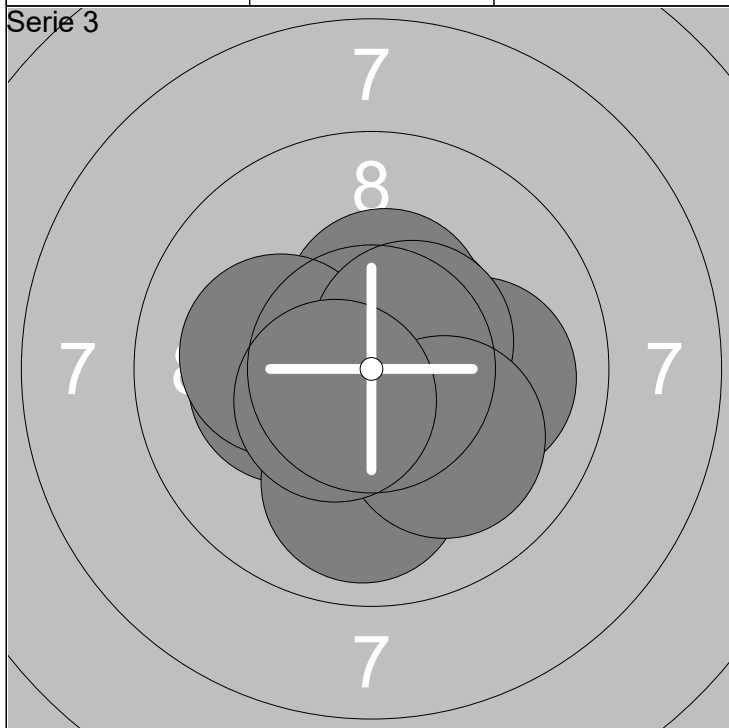

21: 10.0 →	26: 10.1 ←	Serie	102.5
22: 10.2x ←	27: 10.5x ↗		
23: 10.2x ↓	28: 10.0 ↓	Total	308.6
24: 10.5x ↗	29: 10.1 ↘		
25: 10.4x ↑	30: 10.5x ↙		

31: 10.6x ↙	36: 9.9 ←	Serie	102.3
32: 9.9 →	37: 10.5x ↗		
33: 10.3x ↑	38: 9.8 ←	Total	410.9
34: 10.3x ←	39: 10.3x ←		
35: 10.1 ↑	40: 10.6x ↗		